

RV-8

60E G2

DESIGNED BY:

Giuseppe Tompazini



SUPER
PNP
Instruction Manual

FLEXTM
INNOVATIONS
www.flexinnovations.com

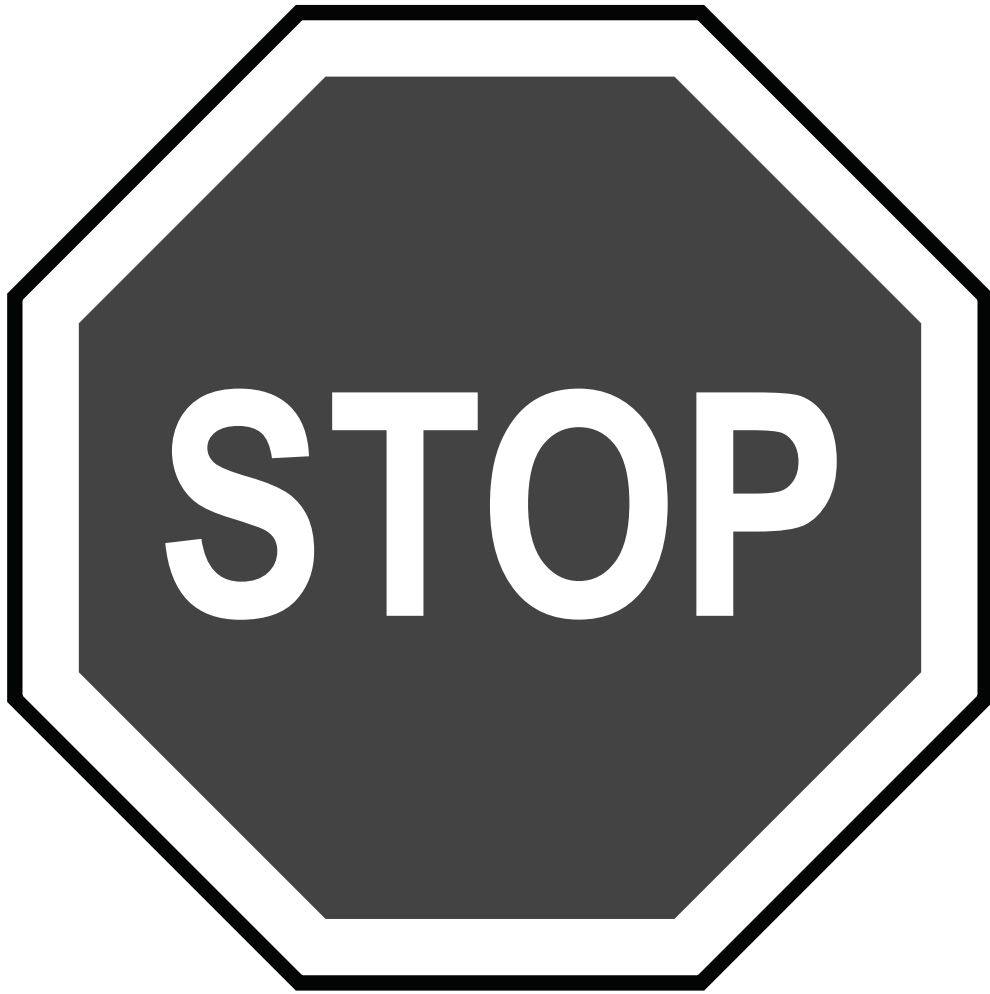

BEFORE CONTINUING WITH THIS INSTRUCTION MANUAL OR ASSEMBLY OF YOUR RV-8 60E G2, PLEASE VISIT OUR WIKI SUPPORT SITE FOR THE LATEST PRODUCT UPDATES , FEATURE CHANGES, MANUAL ADDENDUMS AND FIRMWARE CHANGES FOR BOTH YOUR RV-8 60E G2 AND THE INSTALLED AURA 8 ADVANCED FLIGHT CONTROL SYSTEM.

**wiki.flexinnovations.com/wiki/RV-8_60E_G2
wiki.flexinnovations.com/wiki/Aura**

TABLE OF CONTENTS

Introduction.....	2	Aura 8 AFCS	15
Includes/Requires	2	Aura 8 Servo Connections.....	15
Specifications	3	Transmitter Setup.....	16
Completion Items	3	Receiver Installation	16
Optional Items	3	Connecting Your Receiver to Aura	17
Replacement Parts Listing.....	3	Rudder and Elevator Linkage Installation	18
Special Language Definition.....	4	Rudder and Elevator Linkage Installation (continued).....	19
Importante Information Regarding Warranty	4	Connecting Battery/Arming ESC	20
Safety Warnings and Precautions.....	4	ESC Throttle Calibration	20
Low Voltage Cutoff	4	Control Direction Test	21
Before you Begin.....	5	Aura Sensor Direction Test.....	22
Battery Charging Guidelines.....	5	Cowling, Propeller and Spinner Installation	23
Main Landing Gear Installation.....	6	Battery Installation.....	24
Main Landing Gear Installation (continued).....	7	Center of Gravity Verification	24
Main Landing Gear Installation (continued).....	8	Pre-flight Checklist.....	25
Tail Wheel Installation	9	AMA Safety Code.....	25
Vertical Fin Installation	10	RV-8 60E G2 Aura Optional Features Configuration	26
Horizontal Stabilizer Installation.....	11	Flying your RV-8 60E G2	27
Main Wing Installation.....	11	Airframe Repairs	28
Motor, Cowling and Propeller Installation.....	13	Aircraft Troubleshooting Guide.....	29
Exhaust Installation	14	Limited Warranty	30
Night RV-8 60E G2 LED Connections.....	14	Compliance Information for the European Union.....	30
Connecting a Battery to the LED Controller	14		

INTRODUCTION

Unparalleled Flight Performance

Thank you for purchasing the Flex Innovations RV-8 60E G2, a massive, yet lightweight airframe that offers an incredibly wide flight envelope. From beginners to experts, the RV-8 60E G2 has something to offer everyone. Beautiful scale lines, clear canopy with pilot figure and a beautiful color scheme deliver a true-to-scale presence in the air and on the ground.

With over hundreds of designs, World F3A and Free Style Champion Quique Somenzini has maximized the simplicity and practicality of the RV-8 design and matched it with the incredible Aura 8 Flight Control System (AFCS) for the ultimate stability with out interfering with the pilot's control. It takes less than one-hour to assemble out of the box and remains quick to assemble at the field, yet transportable in size.

With multiple improvements over the original, generation 2 of the RV-8 60E offers better performance, better reliability and better fit and finish!

For the latest updates, features, addendums and more, before assembly, please visit:

wiki.flexinnovations.com/wiki/RV-8_60E_G2

wiki.flexinnovations.com/wiki/Aura

- Pre-installed and custom-tuned Aura 8 Advanced Flight Control System with bounce-back control, three new optimized flight modes and preset Aura Flap System.
- 70-size, 500kV motor and 100A ESC for big power.
- (6) High-Precision Potenza DS-34 servos.
- Light wing loading for easy handling.
- 5-9 minute flight times depending on battery choice and throttle management.
- Light Weight EPO foam that is durable and easy to repair.
- Ball-links on all control surfaces.
- Removable battery tray for easy battery installation.
- Single flap/aileron/navigation light wing connector for quick assembly at field.
- Pin Hinges in all tail control surfaces for free movement and large throws.

INCLUDES

- RV-8 60E G2 airframe with decals applied.
- Aura 8 Advanced Flight Control System (programmed and ready to use).
- Potenza 70 500kv Brushless Motor.
- Hobby Wing 100A ESC with 8A BEC.
- (6) Potenza DS34 High Performance Digital Servo.

REQUIRES

- Minimum 8 channel computer transmitter.
- 4200mAh - 6200mAh 6S 22.2V 35C+ LiPo (FPZB52006S40 recommended).
- Serial capable receiver to match your transmitter, e.g. Spektrum 4651T or Futaba R2001SB.
- 6S LiPo capable battery charger.

SPECIFICATIONS

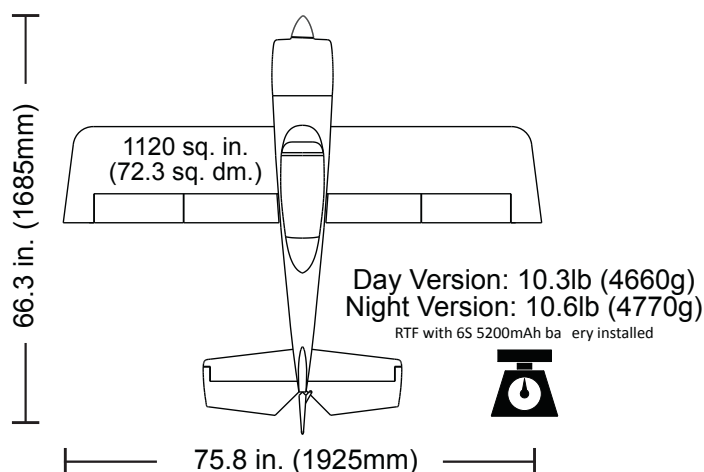

Recommended battery – 6S 4200mAh-6200mAh 35C+ LiPo

COMPLETION ITEMS

INSTALLED!		Potenza 70 500 KV Brushless Outrunner Motor (FPZM1070)
INSTALLED!		Hobby Wing 100A ESC (W/8A BEC) (HW100ESC-5V)
INSTALLED!		Potenza DS34 Digital Metal Gear Mini Servo (FPZDS34)
INSTALLED!		Aura 8 Advanced Flight Control System For RV8 G2 (FPZAURA08ZZRV860G2)
INCLUDED!		17.5 x 7 Electric SR Propeller (FPMP17507E)
NEEDED TO COMPLETE		4200-6200mAh 6S 22.2V 40C+ LiPo (FPZB42006S40, FPZB52006S40, FPZB62006S40)
NEEDED TO COMPLETE		8+ Channel Computer Transmitter
NEEDED TO COMPLETE		Serial-Capable Receiver

OPTIONAL ITEMS

FPM357016	RV-8 60E G1/G2: Float Set w/Struts & LED Green
FPM357016B	RV-8 60E G1/G2: Float Set w/Struts & LED Orange
FPM487016C	RV-8 60E G2: Float Set w/Struts & LED Red
FPM357017	RV-8 60E G1/G2: Keychain Camera Mount
FPM357018	RV-8 60E G1/G2: Wing Bag Set
FPM357020	RV-8 60E G1/G2: Carbon Fiber Landing Gear
FUTR2001SB	Futaba R2001SB SFHSS SBus
SPM4651T	Spektrum DSMX SRXL2 Serial Receiver with Telemetry
SPMAR6610T	Spektrum AR6610T DSMX SRXL2 6Ch Receiver
SPMXC2000	Spektrum S2100 G2 2x100W AC Smart Charger

REPLACEMENT PARTS LISTING

FPM4870A	RV-8 60E G2: Super PNP Day Green
FPM4880A	RV-8 60E G2: Super PNP Night Green
FPM4870B	RV-8 60E G2: Super PNP Orange
FPM4880B	RV-8 60E G2: Super PNP Night Orange
FPM4870C	RV-8 60E G2: Super PNP Day Red
FPM4880C	RV-8 60E G2: Super PNP Night Red
FPM487001A	RV-8 60E G2: Fuselage Green
FPM48001A	RV-8 60E G2: Fuselage with night LED green
FPM357002R	RV-8 60E G1/G2: Right Wing Panel Day Green
FPM357002L	RV-8 60E G1/G2: Left Wing Panel Day Green
FPM358002R	RV-8 60E G1/G2: Right Wing with Night LED Green
FPM358002L	RV-8 60E G1/G2: Left Wing with Night LED Green
FPM487003A	RV-8 60E G2: Horizontal Stabilizer Set Day Green
FPM357004	RV-8 60E G1/G2: Canopy/Hatch Green
FPM357009	RV-8 60E G1/G2: Decal set Green
FPM357010	RV-8 60E G1/G2: Spinner Green
FPM357014	RV-8 60E G1/G2: Cowling with screws Green
FPM487015A	RV-8 60E G2: Vertical Stabilizer set Green
FPM487001B	RV-8 60E G2: Fuselage Orange
FPM488001B	RV-8 60E G2: Fuselage with night LED orange
FPM357002RB	RV-8 60E G1/G2: Right Wing Panel Day Orange
FPM357002LB	RV-8 60E G1/G2: Left Wing Panel Day Orange
FPM358002RB	RV-8 60E G1/G2: Right Wing with Night LED Orange
FPM358002LB	RV-8 60E G1/G2: Left Wing with Night LED Orange
FPM487003B	RV-8 60E G2: Horizontal Stabilizer Set Day Orange
FPM357004B	RV-8 60E G1/G2: Canopy/Hatch Orange
FPM35709B	RV-8 60E G1/G2: Decal set Orange
FPM357010B	RV-8 60E G1/G2: Spinner Orange
FPM357014B	RV-8 60E G1/G2: Cowling with screws Orange
FPM487015B	RV-8 60E G2: Vertical Stabilizer set Orange
FPM487001C	RV-8 60E G2: Fuselage Red
FPM488001C	RV-8 60E G2: Fuselage with night LED Red
FPM487002RC	RV-8 60E G2: Right Wing Panel Day Red
FPM487002LC	RV-8 60E G2: Left Wing Panel Day Red
FPM488002RC	RV-8 60E G2: Right Wing with Night LED Red
FPM488002LC	RV-8 60E G2: Left Wing with Night LED Red
FPM487003C	RV-8 60E G2: Horizontal Stabilizer Set Red
FPM487004C	RV-8 60E G2: Canopy/Hatch Red
FPM487009C	RV-8 60E G2: Decal Set Red
FPM487010C	RV-8 60E G2: Spinner Red
FPM487014C	RV-8 60E G2: Cowling with screws Red
FPM487015C	RV-8 60E G2: Vertical Stabilizer set Red
FPM487017	RV-8 60E G2: G2 Logo Decal
FPM357005	RV-8 60E G1/G2: Aluminum Landing Gear
FPM357006	RV-8 60E G1/G2: Wheel Pants, wheels, axles & tail gear
FPM357007	RV-8 60E G1/G2: Wing and Stab Joiner Tubes
FPM357008	RV-8 60E G1/G2: Pushrod set
FPM357011	RV-8 60E G1/G2: Stabilizer Spotlight & LED set
FPM357012	RV-8 60E G1/G2: Hardware set
FPM357013	RV-8 60E G1/G2: Pilot
FPZM1070	Potenza 70 500KV BL Motor
HW100ESC-5V	Hobby Wing 100A ESC (W/8A BEC)
FPZDS34	Potenza DS34 Digital metal Gear Mini Servo
FPZAURA08ZZRV8	Potenza Aura 8 AFCS for the RV-8 G2

SPECIAL LANGUAGE DEFINITIONS

The following terms are used throughout the product literature to indicate various levels of potential harm when operating this product:

- NOTICE:** Procedures, which if not properly followed, create a possibility of physical property damage AND a little or no possibility of injury.
- CAUTION:** Procedures, which if not properly followed, create the probability of physical property damage AND a possibility of serious injury.
- WARNING:** Procedures, which if not properly followed, create the probability of property damage, collateral damage, and serious injury OR create a high probability of serious injury.

WARNING

AGES 14+

This product is not intended for use by children under 14 years without direct adult supervision.

ATTENTION

Read the ENTIRE instruction manual to become familiar with the features of the product before operating. Failure to assemble or operate the product correctly can result in damage to the product, personal property, and cause serious or fatal injury.

All instructions, warranties and other collateral documents are subject to change at the sole discretion of Flex Innovations, LLC. For up-to-date product literature, please visit our website at www.flexinnovations.com and click on the RV-8 60E G2 and Aura 8 product pages.

IMPORTANT INFORMATION REGARDING WARRANTY

Please read our Warranty and Liability Limitations section before building this product. If you as the Purchaser or user are not prepared to accept the liability associated with the use of this Product, you are advised to return this Product immediately, in new and unused condition, to the place of purchase.

SAFETY WARNINGS AND PRECAUTIONS

Protect yourself and others by following these basic safety guidelines.

1. This manual contains instructions for safety, operation and maintenance. It is essential to read and follow all the instructions and warnings in the manual, prior to assembly, setup or use, in order to operate correctly and avoid damage or serious injury.
2. This model is not a toy, rather it is a sophisticated hobby product and must be operated with caution and common sense. This product requires some basic mechanical ability. Failure to operate this product in a safe and responsible manner could result in injury or damage to the product or other property.
3. This model must be assembled according to these instructions. Do not alter or modify the model outside of these instructions provided by Flex Innovations, LLC, as doing so may render it unsafe and/or un-flyable. It is your responsibility to ensure the airworthiness of the model.
4. Inspect and check for the correct operation of the model and all its components before every flight.
5. If you are not an experienced pilot or have not flown a high-performance model before, it is recommended that you seek assistance from an experienced pilot in your R/C club for your first flights. If you're not a member of a club, the Academy of Model Aeronautics (AMA) has information about clubs in your area whose membership includes experienced pilots.
6. Keep the propeller area clear from such items such as loose clothing, jewelry, long hair, or tools as they can become entangled. Keep your hands and body parts away from the propeller as injury can occur.
7. Never fly in visible moisture or submerge the airplane or any of its electronic components in water. Permanent damage to electronic components may occur, or corrosion of components may lead to intermittent failures.

LOW VOLTAGE CUTOFF

LiPo batteries have a nominal (rated) voltage of 3.7v per cell, and fully charged, reach 4.2v per cell. Batteries are designed to be discharged below the nominal voltage, however, if they are discharged below 3.0v per cell, damage will occur and the pack will loose capacity. For best long term battery life, set a timer and land after a time that leaves approximately 15% of the battery's capacity remaining.

Low voltage cutoff is a feature that is built into the HobbyWing 100A ESC that is designed to protect the connected battery from being discharged too far and causing permanent damage to the cells. Circuitry within the ESC will automatically detect when the input voltage from the battery pack reaches below 3.0V per cell (average) and will remove power to the motor, but still deliver power to the servos so that a safe landing may be made. If the motor begins to lose power rapidly during flight, the LVC has sensed that the total voltage of the pack has dropped below 3.0V per cell average, and the airplane should be landed immediately.

BEFORE YOU BEGIN

NOTICE

If you have the night version of the RV-8 60E G2 we recommend that you dry assemble the airframe and test all the lights before bonding anything permanently in place. Details on the light system can be found on page 14.

NOTICE

The assembly of the RV-8 60E G2 can be accomplished in less than one hour. Prior to assembling the airplane, it is advisable to charge your battery so that you are ready to begin setup upon completion of the assembly of your model.

BATTERY CHARGING GUIDELINES

WARNING

Follow all instructions provided by your battery and charger manufacturer. Failure to comply can result in fire.

We recommend the use of an advanced LiPo balancing charger, such as the Spektrum S2100 G2 2x100W AC Smart Charger for your batteries to get the maximum performance and lifespan from them.

Our airplanes are designed around our Potenza LiPo batteries, and we recommend the Potenza 6S 5200mAh 40C LiPo in the RV-8 60E G2 based on our extensive testing and development. These batteries feature an EC5 connector, so no soldering is required for use in your RV-8 60E G2.

All are available online at www.flexinnovations.com and your local Flex Innovations retailer.

MAIN LANDING GEAR INSTALLATION

Required Tools and Fasteners:



(QTY 2) (QTY 10) (QTY 4)

#1 Phillips Screwdriver
1.5mm Hex Driver
8mm Open End Wrench
12mm Open End Wrench
Adjustable Wrench (optional)

(2) M3x12 Phillips Head Self-Tapping Screw
(10) M3x8 Phillips Head Self-Tapping Screw
(4) M3x20 Phillips Head Machine Screw
Blue Thread Lock

1. Locate the wheel pants, Use a #1 Phillips screwdriver to remove the screws from the wheel pants and separate the wheel pant halves from each other.
2. Locate the landing gear. Place the inside half of the wheel pant against the outside of landing gear leg, and the wheel pant retaining plate against the inside. Note that the retaining plates are identical. Use a #1 Phillips screwdriver and a M3x12 screw to secure the wheel pant half in place. Be sure the landing gear and wheel pant are oriented in the proper direction.

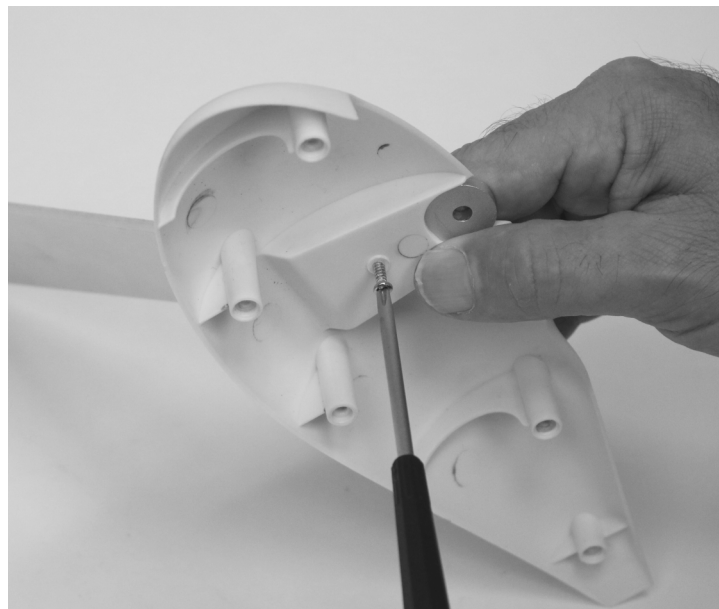
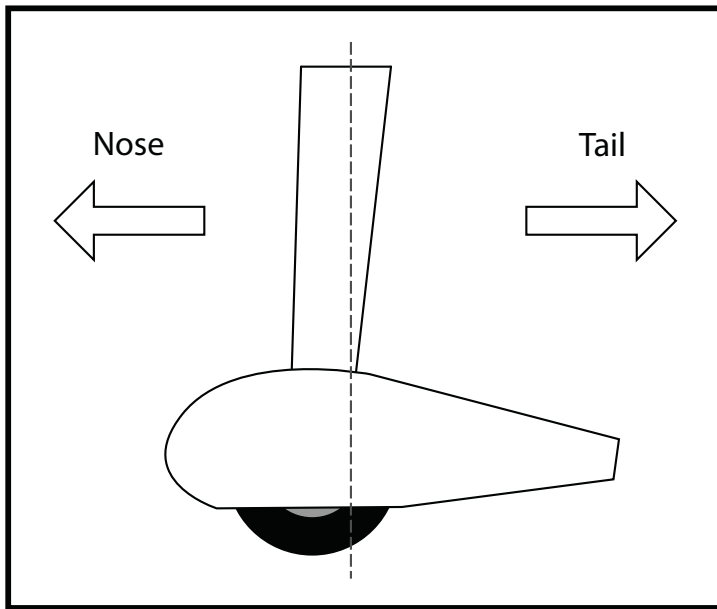

MAIN LANDING GEAR INSTALLATION (CONTINUED)

3. Locate the wheel and axle assembly. Use a 1.5mm hex driver to remove the set screws in the wheel collars. Apply blue thread lock to the set screws and re-assemble.
4. Slide the threaded end of the axle through the landing gear from the outside of the landing gear. Place a washer over the axle and apply blue thread lock to the axle threads. Secure the axle to the landing gear using an M5 nut and an 8mm and 12mm open end wrench.



MAIN LANDING GEAR INSTALLATION (CONTINUED)

5. Use a #1 Phillips screwdriver and five M3x8 self-tapping screws to secure the outside half of the wheel pant to the landing gear assembly.

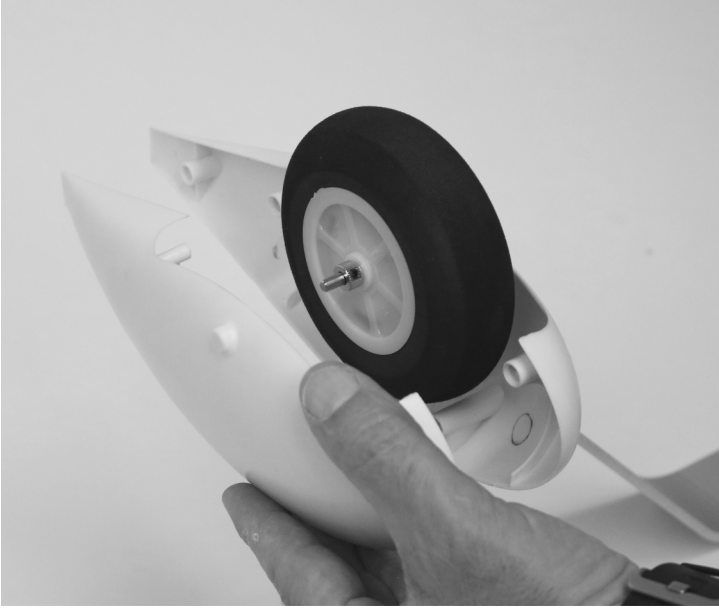

6. Apply blue thread lock to the four M3x20 machine screws. Use a #1 Phillips screwdriver and the four M3x20 screws to secure the landing gear to the fuselage.

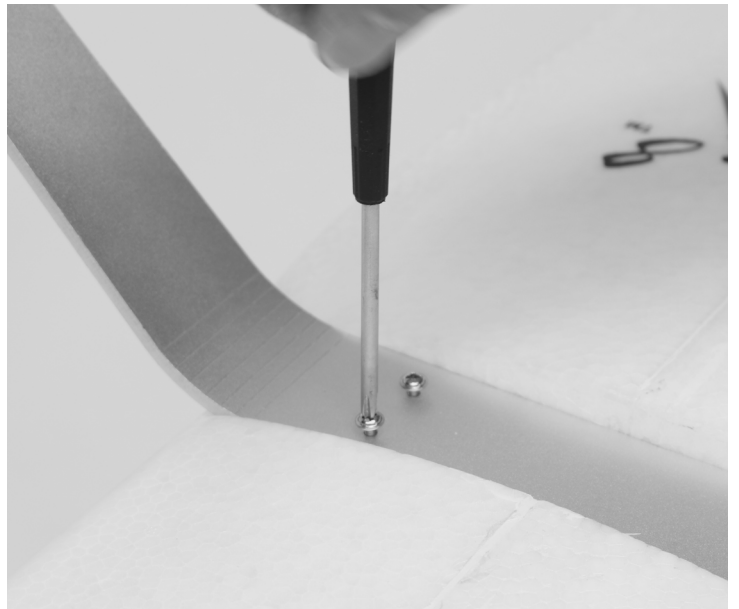
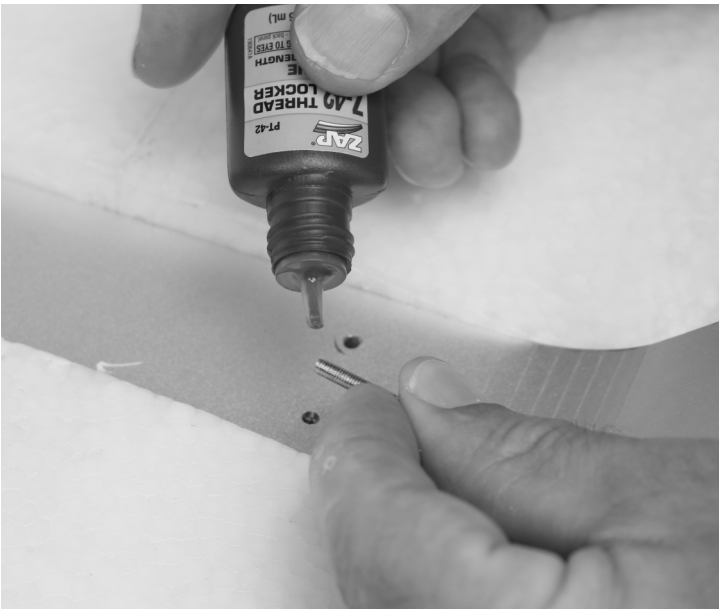

TAIL WHEEL INSTALLATION

Required Tools and Fasteners:

#1 Phillips Screwdriver

(3) M3x7 Phillips Head Self-Tapping Screw



1. Locate the vertical fin assembly, tail wheel and tail wheel retaining plate. Insert the tail wheel into the bottom of the rudder, being sure to orient it so that the tail wheel wire angles towards the tail as the wire moves away from the fuselage.
2. Insert the retaining plate into the cavity on the bottom of the rudder. Use a #1 Phillips screwdriver and the three M3x7 self-tapping screws to secure it in place.

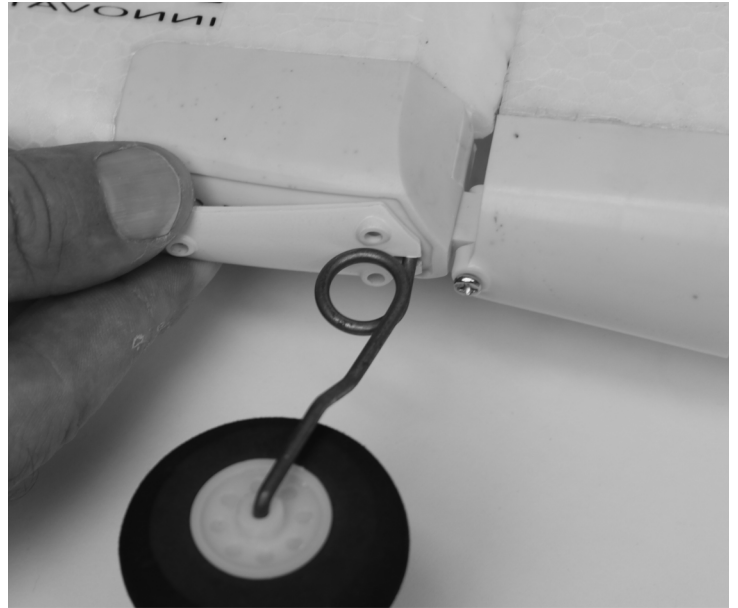
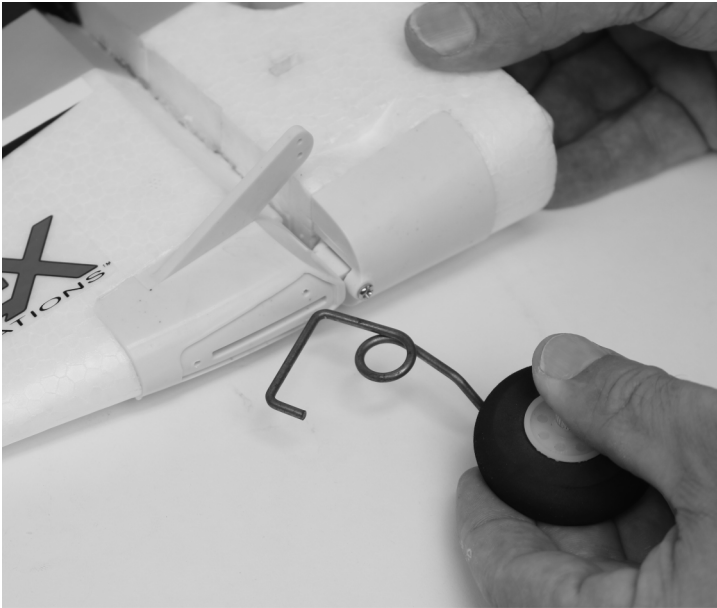

VERTICAL FIN INSTALLATION

Required Tools and Fasteners:

30-Minute Epoxy
Craft Sticks (for mixing epoxy)
Mixing Cup

220 Grit Sandpaper
Paper Towels
Isopropyl Alcohol

1. Locate the vertical fin assembly and vertical fin tube. The vertical fin tube is the shortest tube included with your aircraft. Test fit the vertical fin to the fuselage by inserting the tube into the vertical fin, and then into the fuselage. Confirm everything fits, and aligns appropriately. Make any adjustments and test fit again until you are happy with the fit of the parts.
2. Use 220 grit sandpaper to scuff the vertical fin tube to prepare the surface for gluing. Use a paper towel and isopropyl alcohol to clean the tube after scuffing. It is important to only scuff the tube. **DO NOT** remove a significant amount of material from the tube as it can weaken the structure.

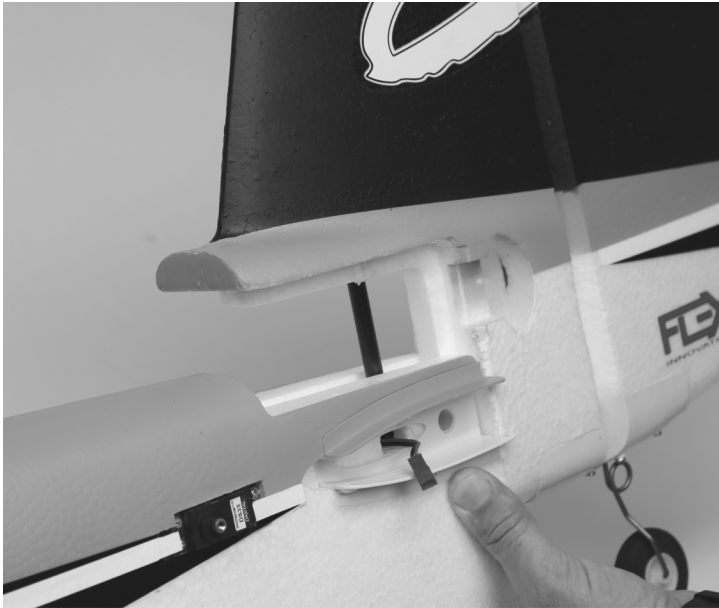

3. Use the craft sticks and mixing cups to mix an adequate amount of 30-minute epoxy. Apply epoxy to the vertical fin tube hole as well as the fuselage parts that meet the vertical fin. Assemble the parts, being sure to wipe up any excess epoxy with a paper towel. Confirm alignment, and wait for the epoxy to cure before proceeding to the next step. **DO NOT** use tape to secure the fin in place as it will remove paint when it is removed.

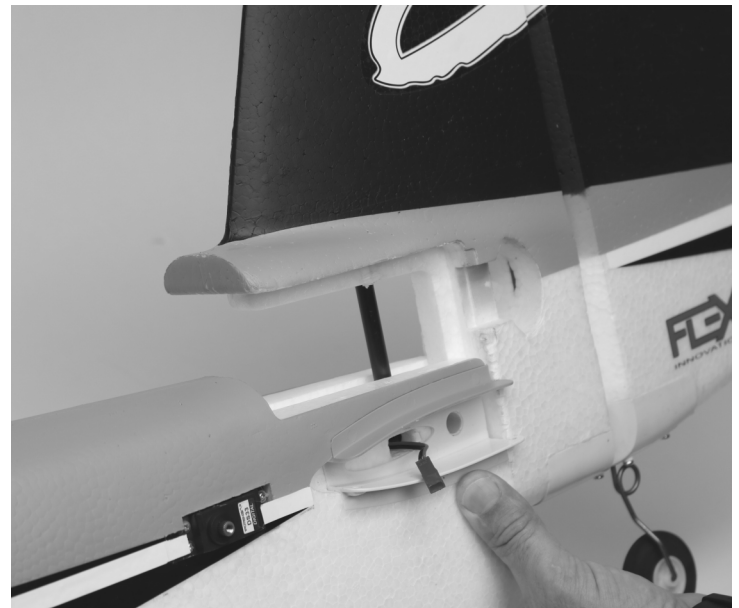

HORIZONTAL STABILIZER INSTALLATION

Required Tools and Fasteners: #1 Phillips Screwdriver

(4) M3x8 Phillips Head Self-Tapping Screw



1. Insert and roughly center the carbon fiber horizontal stabilizer tube in the fuselage.
2. Insert both halves of the horizontal stabilizer onto the tube. Ensure that the control horn faces the bottom of the fuselage and that the elevator jointer tabs line up properly.
3. If you have the night version, connect the red JST LED power connectors.
4. Once both halves of the horizontal stabilizer are seated in place secure them each using two M3x8 self tapping screws.
Note: DO NOT use thread locker on these screws, it will melt the plastic!

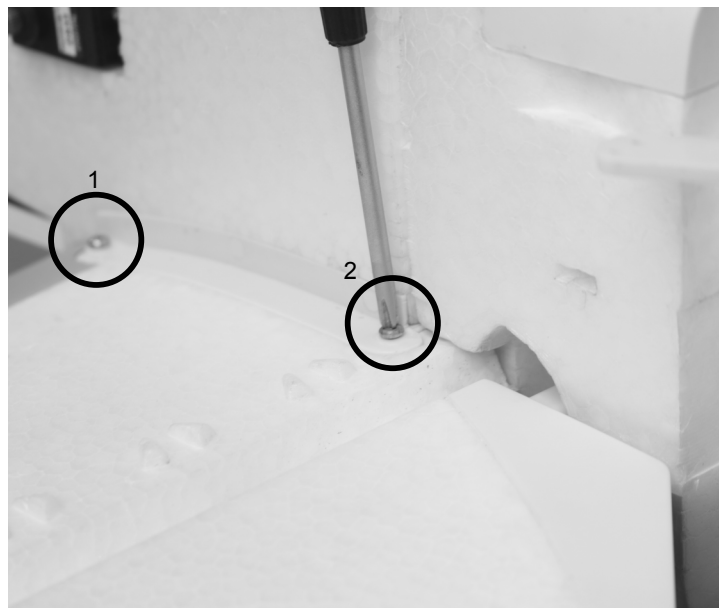

MAIN WING INSTALLATION

Required Tools and Fasteners: (2) M4x18 Thumb Machine Screw

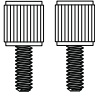

WARNING

REMOVE THE AILERON AND FLAP SERVO SCREWS AND APPLY BLUE THREAD LOCK TO THE SCREWS. RE-INSTALL THE SCREWS AND TIGHTEN FULLY. FAILURE TO DO SO MAY RESULT IN A CRASH

1. Remove the canopy from the fuselage by pulling the latch to the rear and lifting the canopy from the fuselage. Insert the main wing tube into the fuselage and roughly center.
2. Slide the left and right wing panels onto the tube. Ensure the servos orient to the bottom of the fuselage.
3. Connect the single wing connector from each wing panel to the corresponding connector on the fuselage. If you have a night version, connect the wing red JST to the LED controller red JST connector.
4. Fully seat the wing into the fuselage while being careful to align the wing mounting tab with the slot in the fuselage. Be sure to avoid pinching any wires during this process. Secure the wing to the fuselage using a M4x18 thumb screw.

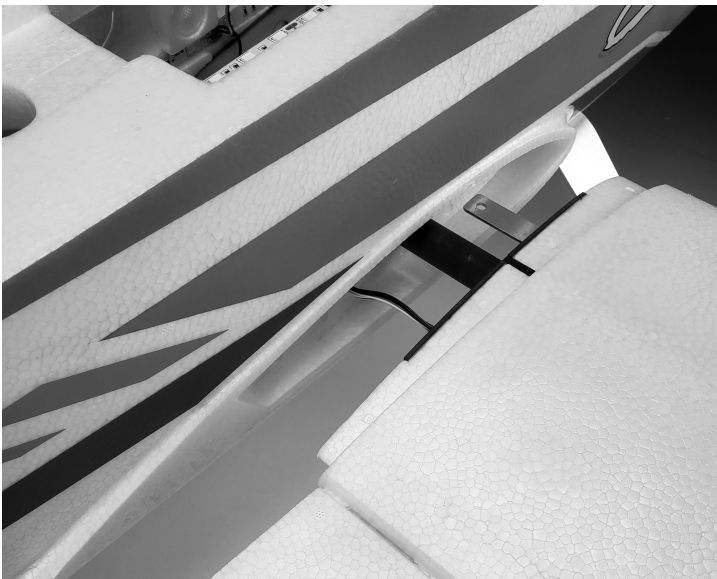
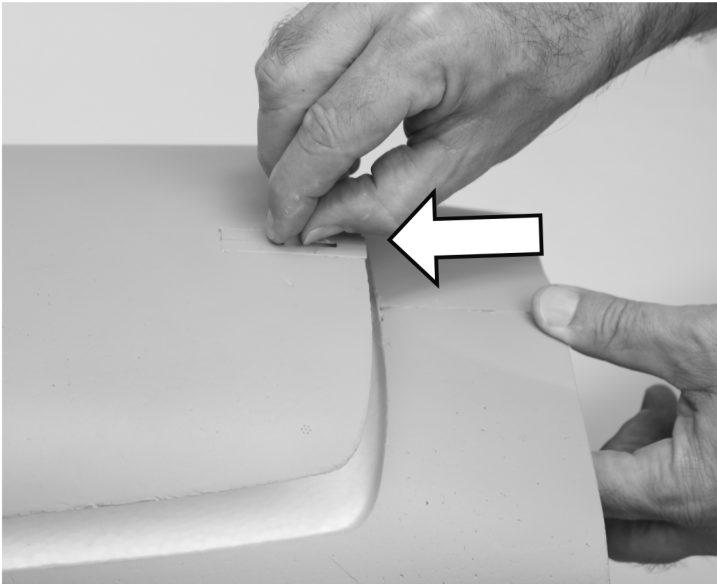

MOTOR, COWLING AND PROPELLER INSTALLATION

Required Tools and Fasteners:

- Prop Adapter Assembly
- (4) M3x10 Socket Head Cap Screw
- (4) M3x22 Phillips Button Head Screw

- Motor Assembly
- (4) M4x8 Phillips Flat Head Screw
- 2.5mm Hex Driver
- #2 Phillips Screwdriver
- Blue Thread Lock

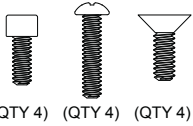

Note: Do not complete transmitter, receiver and/or Aura setup with the propeller installed.

1. Locate the motor assembly, the prop adapter assembly and the M3x10 socket head cap screws for the prop adapter assembly. Apply blue thread lock to the screws and use a 2.5mm hex driver to install the prop adapter onto the front of the motor.
2. Locate the aluminum x-mount for the motor. Apply blue thread lock to the M4x12 Phillips flat head screws and use a #2 Phillips screwdriver to secure the x-mount to the back of the motor. Be sure to orient the mount so that the flat head screws sink into the mount and sit flush with the back of the motor mount.
3. Plug the motor wires into the ESC wires. There is no proper polarity; plug any one of the motor wires into any one of the ESC wires. If the motor spins backwards when you test motor function, simply swap any two wires to make the motor spin in the proper direction.
4. Apply blue thread lock to the M4x22 Phillips button head screws and use a #2 Phillips screwdriver to secure the motor to the firewall of the aircraft.

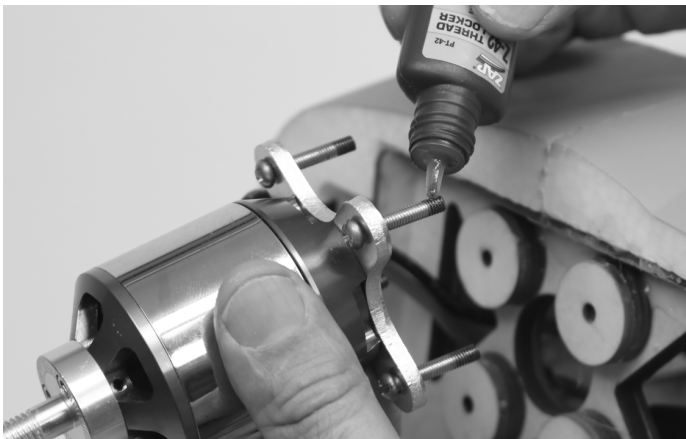
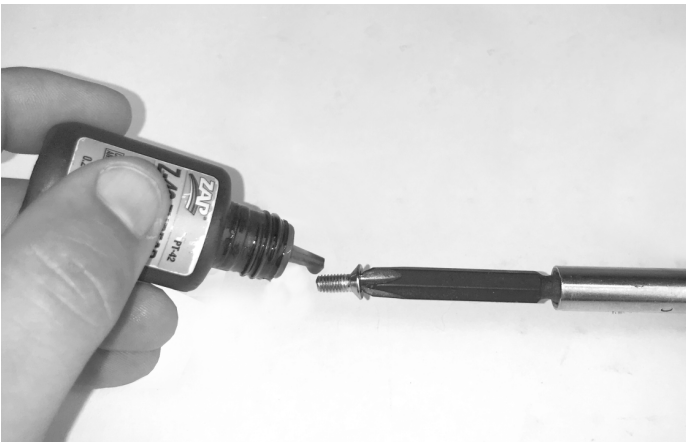
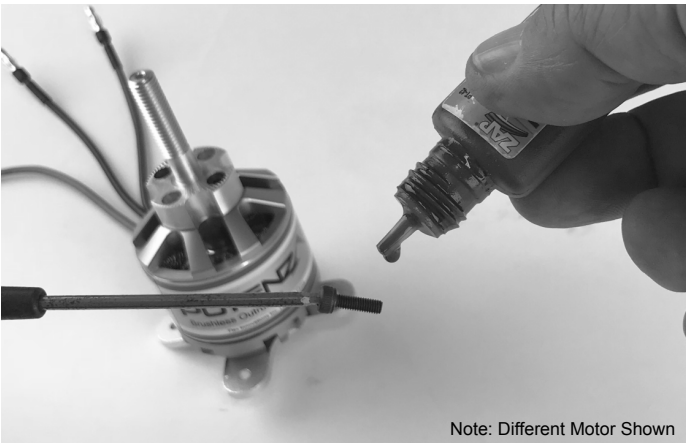

EXHAUST INSTALLATION

Required Tools and Fasteners: Medium CA CA Accelerator

1. Locate the two black foam scale exhaust pieces. Use medium CA to secure the exhaust as shown in the photo below. You can also use CA accelerator to help speed up the process.



NIGHT RV-8 60E G2 LED CONNECTIONS

If you have purchased the Night version of the RV-8 60E G2, this page will cover all LED light connections. If you did not purchase the night version, skip ahead to the next page.

1. There is a connection for each wing panel and a connection for each horizontal stabilizer half. Connect each one of these connectors to the corresponding connectors that are routed to the openings where you install the wings and the horizontal stab half.
2. If using the floats with lights, connect each JST for the float set to the LED controller in the fuselage. Route the leads through the cooling hole in the bottom of the fuselage. Secure the wire to the flat strut and fuselage using water proof tape.

CONNECTING A BATTERY TO THE LED CONTROLLER

The LEDs on your aircraft are switchable via the transmitter, and are designed to be powered by 12 volts (3S LiPo) through the 6S JST-XH balance tab on the LED controller. **By default, the LED controller is left unplugged. If the servo lead of the LED controller is not plugged into the Aura or a receiver, the LED controller will default in the ON position when powered, allowing the Night Version to be flown at night with a basic 8-channel transmitter or receiver.**

IN ORDER TO CONTROL THE LEDS FROM THE TRANSMITTER, YOU MUST USE A STANDARD RECEIVER THAT IS CAPABLE OF 9+ CHANNELS, AND KEEPS THE SERVO PORTS ACTIVE WHEN USING A DIGITAL DATA STREAM (like S.Bus, SRXL2 etc.).



WARNING

You MUST use an independent 3S Li-Po battery to power the LEDs in the RV-8 60E G2. Failure to do so can damage your flight batteries. We recommend the use of the Potenza 3S 2200mAh 45C Li-Po (FPZB22003S45) or the Potenza 3S 500mAh 25C Li-Po (FPZB5003S25).



WARNING

Do not leave the battery plugged into the LED controller for extended periods of time. Doing so can damage the battery. Average current draw for the lighting system is 2.2A/h

**LED
CONTROLLER**

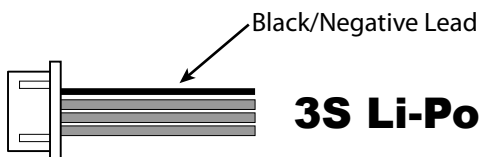
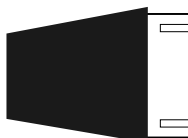

3S Li-Po

AURA 8 AFCS

The Aura 8 AFCS (Advanced Flight Control System) comes programmed and pre-installed in your RV-8 60E G2, making setup a breeze. This highly-refined 3-axis gyro makes the RV-8 60E G2 fly like it is a larger aircraft and in less wind. Thanks to the Aura's advanced implementation, it not only enhances the flying experience, but it never interferes with the pilot's control.

The Aura 8 AFCS comes configured with Flight Modes (dual rates, expos and gyro settings) set by the Flex Innovations team, and offers a great starting point for most pilots. **Since these are already configured for you in the Aura, there is no need to set up dual rates, expos or flaps in your transmitter.** Simply follow the Transmitter Configuration Guide in this manual for complete details on the transmitter programming required for the RV-8 60E G2 and Aura 8 AFCS.

Visit wiki.flexinnovations.com/wiki/Aura for the latest Aura-related product information and updates.

The following shows the pre-configured Aura flight modes in the RV-8 60E G2.

RV-8 60E G2 Aura Profile

Flight Mode 1: Sport (Gyro On)

- For general flight.
- Rates are low and expos tuned for general flight (no live wing).
- Gyro is set to low.

Flight Mode 2: Advanced (Gyro On)

- For more advanced aerobatics like tumbles and spins while at high airspeeds.
- Rates are moderately high and expos are tuned for comfortable flight.
- Flaps work in conjunction with ailerons for added roll authority (live wing).
- Gyro is set to low.

Flight Mode 3: Slow Speed 3D (Gyro On)

- For slow speed, 3D flight.
- Rates are highest and expos are tuned for comfortable flight.
- Flaps work in conjunction with ailerons for added roll authority (live wing).
- Gyro is set to its highest setting and may oscillate in high speed flight under certain conditions.

In all Flight Modes, the flaps function with the operation of CH6 (Aux 1) on the transmitter.

NOTE - Aileron travel will not change with the flight mode switch. The addition of flaps with the ailerons significantly increases the roll rate, making the change feel like a low versus high rate.

NOTE - Rudder stick movement will also move the ailerons and elevator. Flap (CH6) movement will also move the elevator. This is NORMAL and is the pre-programmed mixing.

Each of the modes has been tuned by our team to offer a solid start. Because tastes in control feel are unique, if changes in rate and expo are needed adjustments should be made through Aura. Changes on gain value can only be made through the Aura.

The Aura 8 AFCS Profile for the RV-8 60E G2 can be enhanced with optional features without the need of a computer. For further details, please see the section of this manual titled **RV-8 60E G2 Aura Optional Features Configuration** on page 26.

AURA 8 SERVO CONNECTIONS

DEFAULT AURA CONNECTIONS

- S1 – Throttle**
- S2 – Left Aileron**
- S3 – Right Aileron**
- S4 – Elevator**
- S5 – Rudder**
- S6 – Left Flap**
- S7 – Right Flap**
- S8 – Water Rudder (optional, with floats)**

Port B – Serial Receiver Input

Mini Port A&B – Remote Receiver Inputs

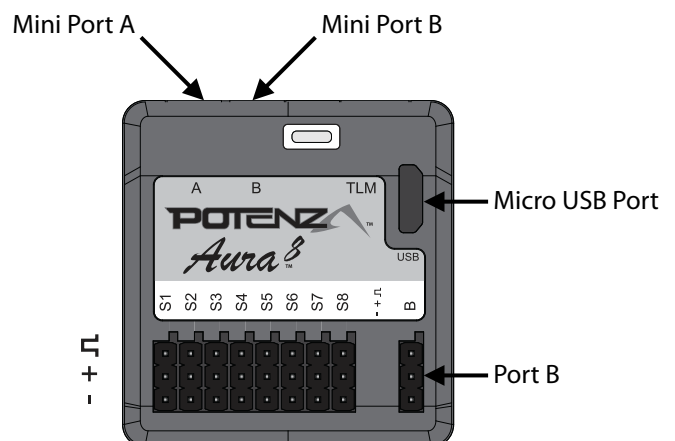

TRANSMITTER SETUP

The included Aura 8 is designed to work seamlessly with all popular transmitter and receiver brands, however, transmitter setup is significantly different than when setting up a model without Aura. Follow these steps:

1. Start with a new model memory in your transmitter. Reset it to be certain it is set to defaults.
2. Adjust your transmitter settings according to the Transmitter Configuration Guide below.
3. **Make ONLY the changes shown in the Transmitter Configuration Guide.** No other changes are required.

Transmitter Configuration Guide

	Spektrum, Futaba, JR ¹ & Graupner	FrSky	Jeti (EX-Bus)
Wing/Tail Type	1 Aileron, 1 Elevator, 1 Rudder	1 Aileron, 1 Elevator, 1 Rudder	1 Aileron, 1 Elevator, 1 Rudder
End Points (Travel Adjust or ATV)	Ail/Ele/Rud – 125%	Ail/Ele/Rud – 100%	Aileron/Ele/Rud – 100%
	Thro/CH5/CH6 – 100%	Thro/CH5/CH6 – 84%	Thro/CH5/CH6 – 80%
Reversing ²	Not Allowed		
Sub-Trim	Verify at Zero, NOT ALLOWED		
Trim Levers	Verify at Zero		
CH5 (Gear) – Flight Mode	Assign to a 3 Position Switch		
CH6 (Aux 1) – Flaps	Assign to a 3 Position Switch (Do NOT use Transmitter Flap System)		
CH7 (Aux 2) – Gyro On/Off ³	Assign to a 2 Position Switch		
CH8 (Aux 3) – Crow ³	Assign to a 2 Position Switch		
First Flight Timer ⁴	For your first flight, set to 5:30		

1 JR customers should use JR XBUS Mode A, and follow the chart above. This is the preferred JR DMSS connection to Aura.

2 If you are using a Futaba transmitter, please note that some Futaba transmitters have the throttle set to reversed by default. We recommend that you leave the reversing set to the defaults and reverse it if needed after testing. **NOTE: do all throttle testing with the prop removed!**

3 The default Aura program has Gyro On/Off and Crow disabled, please see the section of this manual titled **RV-8 60E G2 Aura Optional Features Configuration** on page 26 to enable Gyro On/Off and Crow.

4 This time is a safe starting point for most pilots. This aircraft can typically fly anywhere between 5-1/2 to 10 minutes (with 6S 5200mAh LiPo), depending on an individual's flying style.

FOR CUSTOMERS USING TRANSMITTERS OTHER THAN WHAT IS LISTED IN THE CHART ABOVE, PLEASE VISIT OUR WIKI PAGE FOR INSTRUCTIONS SPECIFIC TO YOUR TRANSMITTER AND RECEIVER BRAND

HITEC – wiki.flexinnovations.com/wiki/Aura/HitecSbusUse

RECEIVER INSTALLATION

Choosing a Receiver

Aura will auto-detect modern serial receiver connections. For use in the RV-8 60E G2, only a serial receiver connection or two Spektrum Remote Receivers can be used. Below are a few examples of serial receivers that can be used with the Aura 8. This is not a complete list of compatible receivers, rather a short list to assist in your receiver selection.

Spektrum Remote Receivers – SPM9745 (2 Required)

Spektrum SRXL – SPMAR6610T, SPMAR8020T, SPMAR10100T

Spektrum SRXL2 – SPM4651T, SPM4650

Futaba S.Bus – Futaba R7008SB, R2001SB, R6202SBW

Hitec S.Bus – Optima SL, Maxima SL

FrSky S.Bus – RX4R, RX6R

Graupner HoTT (Sum D of 8) – GR12L, GR16L

JR XBus (Mode A & Mode B) – RG012BX, RG613BX, RG821BX

Jeti EX-Bus – REX10, R9 EX, REX6

CONNECTING YOUR RECEIVER TO AURA

Serial Receivers

If using a standard serial receiver, connect the provided male to male cable to your receiver's serial port. Connect the other end of the cable to Aura Port B noting proper polarity.

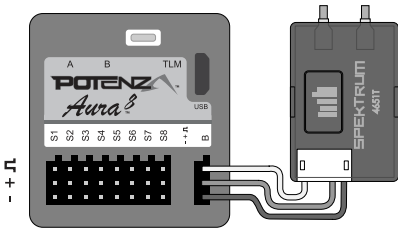

Note: SRXL2 receivers like the 4651T or the AR6610T require the use of a different cable to connect to Aura. The cable is included with the receiver when it is purchased directly from Flex Innovations. You can also purchase the cable itself at flexinnovations.com (FPZA1039).

Note: If you are using Futaba S.Bus, be sure to use the proper S.Bus port in your receiver. DO NOT use the S.Bus2 port, as it is not supported for use with the Aura 8. Refer to your manufacturer's instructions for proper S.Bus use.

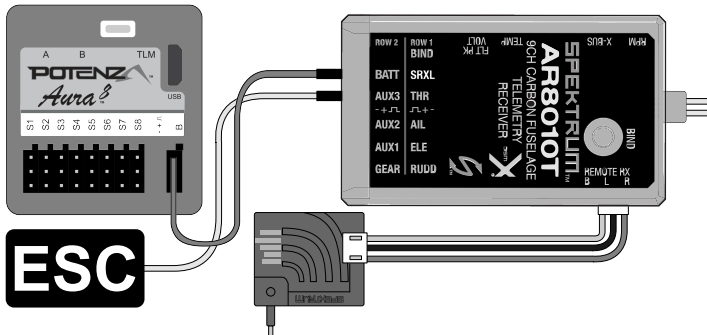
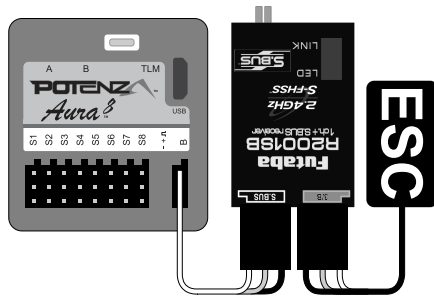

Note: When using Spektrum SRXL or SRXL2 to connect to the Aura, always connect the remote receivers to the Spektrum receiver, NOT to the Aura.

Binding Your Receiver

Bind your receiver to your transmitter per your receiver and transmitter manufacturer's instructions.

Aura 8 Auto-Detect

Once your receiver is bound, powered, and connected to the Aura, the Aura will begin the Auto-Detect process to learn what type of receiver you are using and set itself up for that specific system. Auto-Detect is indicated by a series of sweeping LEDs of various colors. After Auto-Detect is completed, verify that Aura is on and receiving data from your receiver by looking at the LEDs on the Aura.

Ready-To-Fly:

Solid Orange LED: Aura On and Calibrated

Solid Green LED: Aura receiving Valid receiver data



Spektrum Remote Receivers

If using two Spektrum Remote Receivers, connect them to Aura Mini Port A and Mini Port B using the cable provided with your receivers.

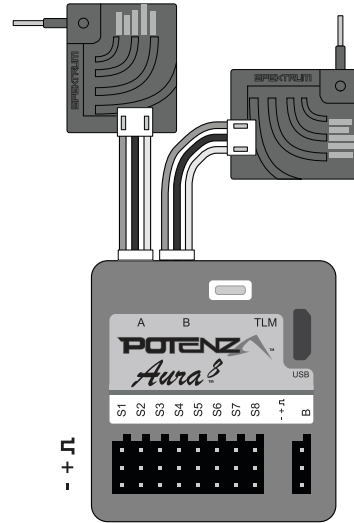

Binding Your Remote Receivers

1. With the transmitter and aircraft powered OFF, place a bind plug into Aura Port S8.
2. Power on the aircraft. Your remote receivers should flash rapidly, indicating it is in bind mode.
3. Bind your transmitter to the remote receivers per your transmitter manufacturer's instructions. This is typically done by pressing and holding the bind button on your Spektrum transmitter while powering it on.
4. Verify the receivers are bound by looking at the LED on the Remote Receivers. This is typically indicated by a solid orange LED on Spektrum Remote Receivers.
5. Remove the bind plug from Aura Port S8.

Possible Errors:

Flashing Orange LED: Aura Moved During Power Up

No Green LED: Aura NOT receiving receiver data



RUDDER AND ELEVATOR LINKAGE INSTALLATION

Required Tools and Fasteners:

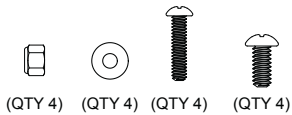

Elevator and Rudder Pushrod Assemblies
(4) M2x10 Phillips Head Machine Screw
(4) M2 Flat Washer
(4) M2 Lock Nut
(4) M3x6 Phillips Head Machine Screw

#2 Phillips Screwdriver
#0 Phillips Screwdriver
Needle-Nosed Pliers (or Hemostats)
Blue Thread Lock

1. Locate the rudder and elevator pushrod assemblies, as well as the servo arms and hardware. Note that both pushrods and servo arms are the same length.
2. Power on your transmitter, and power on the airplane. Once the Aura has initialized and you can verify that the servos are operating properly, ensure that the aircraft is stationary when making any adjustments to servo arm positions or to pushrod lengths. Since the default Aura configuration has Gyro Enabled in all flight modes you will notice that any motion of the airplane will result in a corresponding motion of the control surfaces.
3. With the aircraft still powered on, install the rudder and elevator servo arms perpendicular to the servo case, being sure to orient the servo arm towards the bottom of the fuselage. Apply blue thread lock to the M3x6 Phillips head machine screw, and secure the servo arm in place with a #2 Phillips screwdriver.

WARNING

DUE TO VARIANCES IN PRODUCTION AND THE LARGE CONTROL SURFACE THROWS ON THIS AIRCRAFT, PROPER SERVO CENTERING AND TRAVEL ADJUSTMENT IS CRITICAL TO PREVENT SERVO OVER TRAVEL AND FAILURE. IF THE SERVO ARMS ON YOUR AIRCRAFT DO NOT SIT PERPENDICULAR TO THE SERVO CASE, YOU MUST USE THE AURA CONFIG TOOL TO ADJUST THE SUB-TRIM AND OUTPUT SCALE VALUES TO PREVENT OVER TRAVEL OF THE SERVOS.

To download the Aura Config Tool, please visit: <https://www.flexinnovations.com/aura-config-tool-install/>

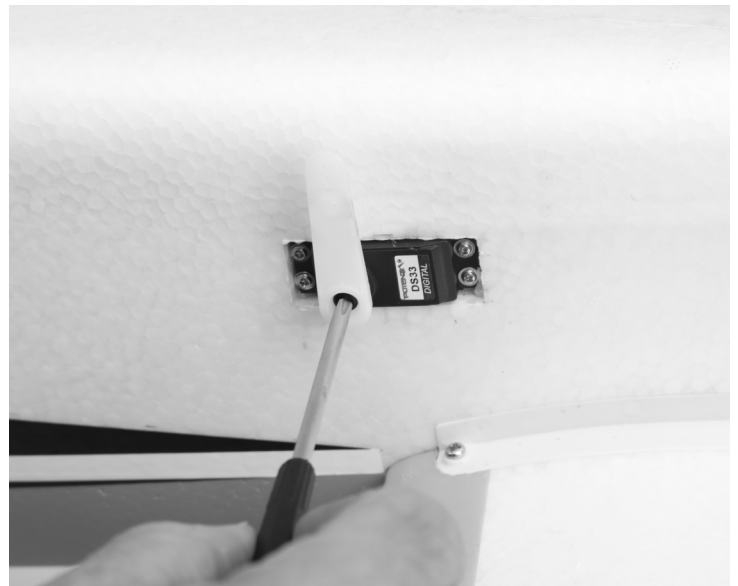

RUDDER AND ELEVATOR LINKAGE INSTALLATION (CONTINUED)

WARNING

Note: Do not use thread locker on the bolts holding the push rods to the servo arms or the control horns!
Using thread locker will weaken the plastic, void your warranty, and cause your airplane to crash!

- Use a #0 Phillips screwdriver, M2x10 machine screw, M2 washer and M2 lock nut to secure the linkage to the control horn and servo arm. Use the diagrams below for proper control horn and servo arm linkage locations. The sequence of the hardware components is as follows:
 - M2x10 Machine Screw
 - M2 Washer
 - Servo Arm or Control Horn
 - M2 Lock Nut
- Repeat the process for the other control linkage.

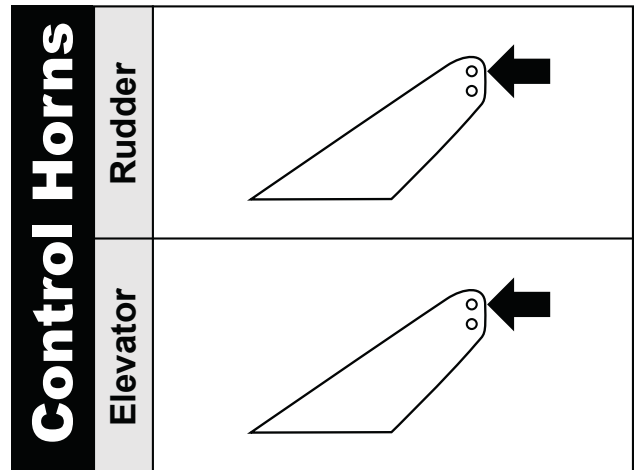
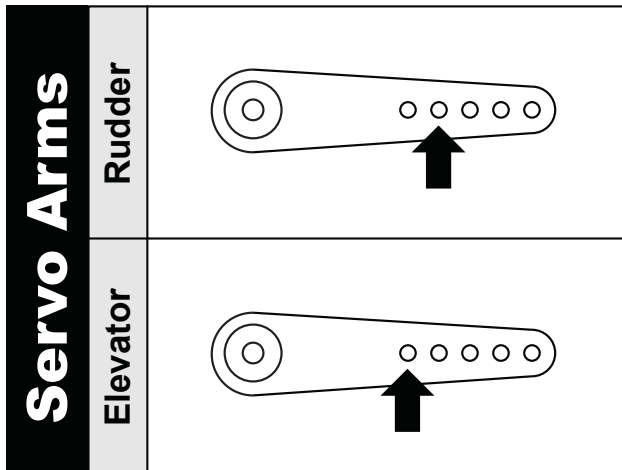

CONNECTING BATTERY/ARMING ESC

Observe the following procedures to safely power up your model after it has been bound. **Ensure propeller is removed unless this sequence is followed to power up before flight.**

1. Turn on the transmitter. **Lower the throttle stick AND throttle trim** to their lowest settings. Be sure to wait for your transmitter to indicate it the radio signal is being broadcast before proceeding.

If a battery is connected to the ESC with the throttle fully open on the transmitter, the ESC will enter programming mode. If this occurs, simply disconnect the battery, lower the throttle and reconnect the battery.

2. Ensure the aileron, elevator and rudder gimbals are centered.
3. With the airplane on a solid surface, connect the battery to the ESC and wait. The ESC will make the motor emit a series of audible tones during its initialization process.
4. The ESC will make the motor emit a short, final tone sequence indicating that the ESC is now armed and that the motor will spin in response to throttle stick movement.

WARNING

When making adjustments to linkages, transmitter settings, or the Aura 8 flight control system, remove the propeller to guard against accidental spool up.

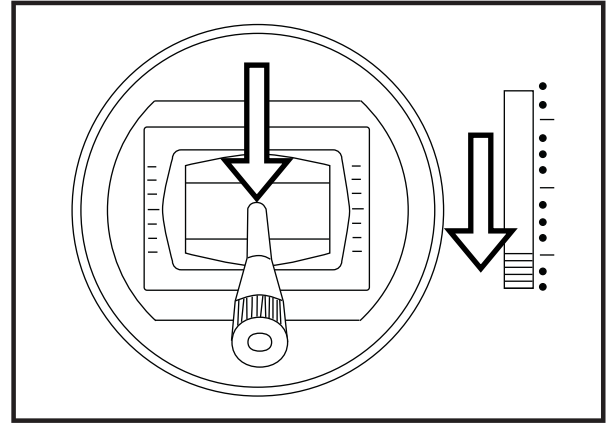

CAUTION

Always connect the battery when the throttle stick and throttle trim are in the idle/cut-off position.

WARNING

Hold aircraft securely when connecting the battery before flight. Always ensure that the propeller is clear of any and all objects as they may become entangled.

ESC THROTTLE CALIBRATION

In order to map the full range of the ESC output to your throttle stick motion you will have to preform an ESC throttle calibration. **NOTE: Execute ESC throttle calibration with the propeller and spinner removed.**

1. Power on your transmitter, DISABLE any throttle hold or throttle kill switches, **completely lower the throttle trim** and set the stick to full throttle.
2. Connect the flight pack to your RV-8 60E G2.
3. Listen for the tones coming from the ESC through the motor, about 2 seconds after RF is engaged you should hear two tones.
4. Pull your throttle stick back to idle.
5. Listen for the ESC arming tones from the motor.

The ESC throttle range has now been properly calibrated, and is stored in the ESC's memory until it is calibrated again. You can repeat this process as many times as necessary.

CAUTION

Note: After throttle calibration is complete it is necessary to reset the failsafe on your receiver (see your radio documentation, this may require a re-bind).

CONTROL DIRECTION TEST

Refer to the chart below to determine the proper control surface responses to transmitter control inputs.

If controls are reversed, DO NOT REVERSE CONTROLS IN YOUR TRANSMITTER OR IN THE AURA CONFIG TOOL. Email us at support@flexinnovations.com for corrective action. Note that BOTH the Transmitter Control Direction Test AND the Flight Controller Sensor Direction Test MUST BE PASSED! IF EITHER ONE DOES NOT PASS, DO NOT FLY!

NOTE: There is pre-configured rudder to aileron and rudder to elevator mixing programmed into the Aura. Simultaneous movement of these control surfaces with rudder input is intentional and completely **NORMAL**.

Additionally: Aura has a built-in flap system that moves the flaps at a slower speed. There is also flap to elevator mixing configured in the Aura Flap System. This speed and mixing is intentional and completely **NORMAL**.

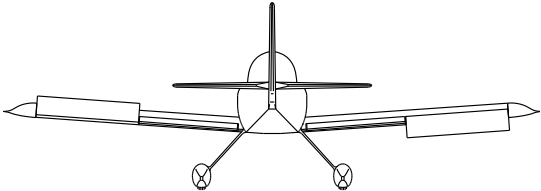
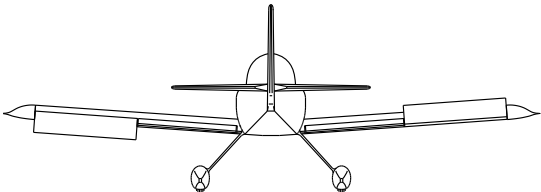
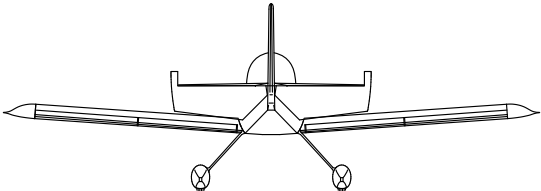
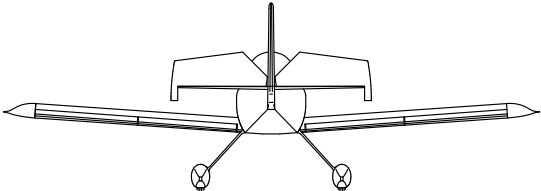
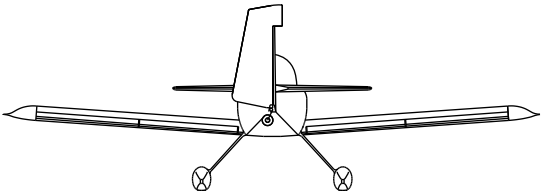
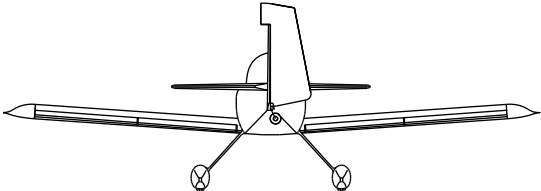
	Transmitter Command	Proper Control Surface Deflection
AILERO	Stick Left	
	Stick Right	
ELEVATOR	Stick Forward	
	Stick Aft	
RUDDER	Stick Left	
	Stick Right	

AURA SENSOR DIRECTION TEST

Perform a test of the gyro system to verify the corrections made for a given movement are correct. **If any of the tests do not result in the correct reaction from the airplane's gyro system, DO NOT FLY THE AIRPLANE, and contact us via email at support@flexinnovations.com**

The flight control system activates with RF broadcast. Perform these tests in Mode 3 (higher gain) for better visibility and then in Mode 2, and finally in, Mode 1. Control surface deflections are exaggerated in the pictures below for clarity. Please note that the control surfaces will move ONLY while the aircraft is being ROTATED.

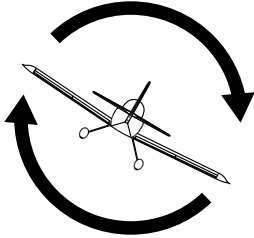
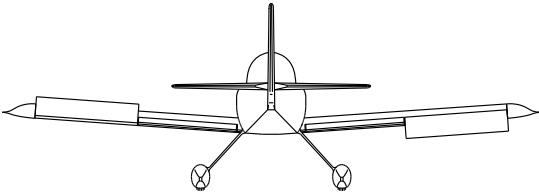
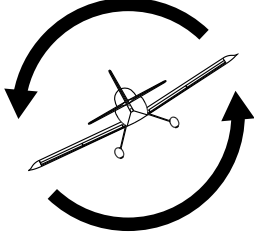
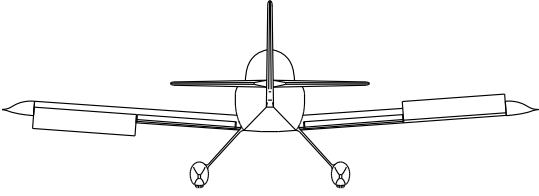
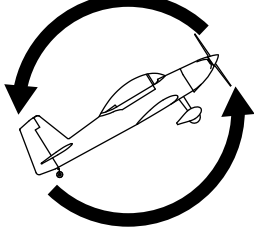
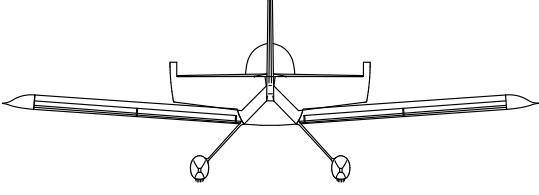
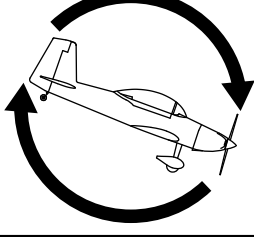
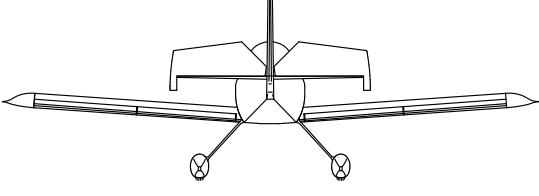
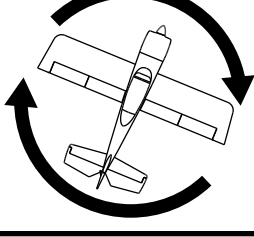
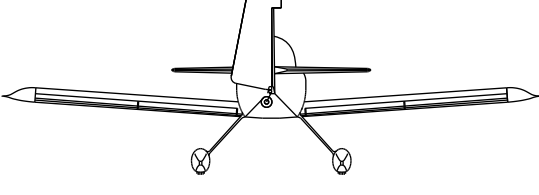
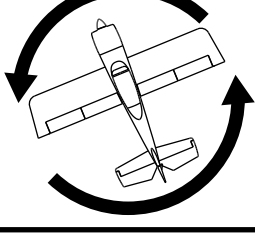
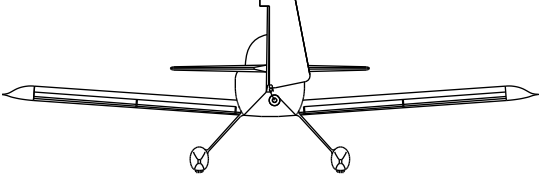
	Aircraft Movement	Proper Control Surface Deflection
AILERON		
		
ELEVATOR		
		
RUDDER		
		

COWLING, PROPELLER AND SPINNER INSTALLATION

Required Tools and Fasteners:

(2) M3x8 Phillips Button Head Screw
(1) M3x10 Phillips Button Head Screw

M8 Nut & Washer for Propeller Adapter
#1 Phillips Screwdriver

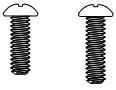

(QTY 2) (QTY 1)

1. Use a #1 Phillips screwdriver and two M3x8 Phillips button head screws to secure the the cowling to the aircraft.
2. Place the propeller onto the propeller adapter, with the convex side facing forward. Place the propeller washer over the shaft, and thread the propeller nut onto the propeller adapter. Use an adjustable wrench to tighten the propeller nut.
3. Place the spinner over the prop shaft, being sure to align the cutouts in the spinner with the propeller blades. Use a M3x10 Phillips button head screw and a #1 Phillips screwdriver to secure the spinner in place.

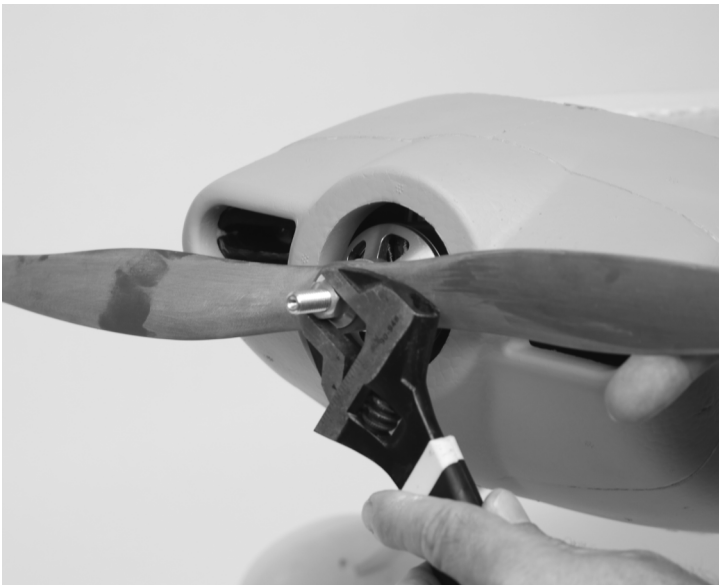
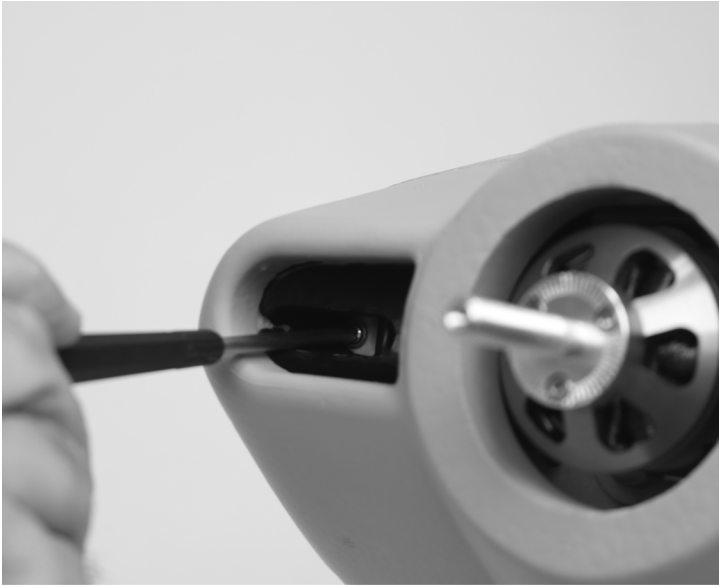

BATTERY INSTALLATION

1. Push the spring-loaded battery latch tab back to release the battery hatch. Lift the hatch away from the fuselage, starting at the front.
2. Remove the battery tray by loosening the thumb screw. Slide the tray rearward as you gently lift the tray away from the fuselage.
3. Install an adhesive-backed hook strip to the battery tray, and an adhesive-backed loop strip to the battery.
4. Place the battery on the tray, and secure it in place with the hook and loop straps provided.
5. Re-install the tray into the battery compartment by aligning the front tab on the tray with the appropriate slot in the fuselage sub-frame. Once seated in place, secure the tray to the sub-frame using the thumb screw.
6. Reinstall the hatch, and confirm that the latch has positively engaged.

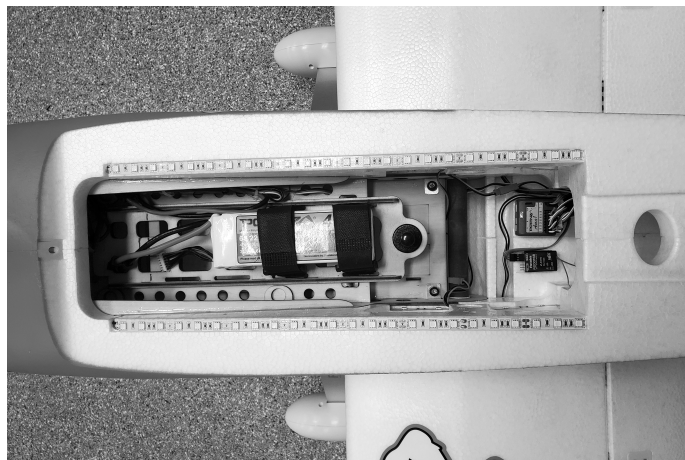

⚠ CAUTION

Always keep limbs clear from the propeller when the battery is connected. After the ESC arms, the propeller will rotate when the throttle is moved. Unlike an internal combustion engine, electric motors apply more voltage to counteract resistance, therefore any object that is entangled in the propeller will be severely damaged before the motor will stop

⚠ WARNING

When making adjustments to linkages, transmitter settings, or the Aura 8 flight control system, remove the propeller to guard against accidental spool up.

CENTER OF GRAVITY VERIFICATION

The center of gravity (CG) location for your aircraft is located in two locations depending on the flying style you wish to fly.

For general sport flying, the CG is located 11-7/32 inches (285mm) FORWARD of the trailing edge of the wing.

For more aerobatic capability, the CG is located 10-13/16 inches (275mm) FORWARD of the trailing edge of the wing.

These CGs are measured by lifting the completed airplane upright, with all components installed. This location was determined from many test flights by designer and multi-time world aerobatic champion, Quique Somenzini. Lift the airplane from the underside of the wing to check CG.

Setting the center of gravity is one of the most important steps for success, particularly with a new airplane. The RV-8 is a high-performance airplane with large control surface throws, and a high thrust-to-weight ratio. These two factors combined make it a very enjoyable aircraft to fly, but if the CG is not within an acceptable range, it will make the aircraft difficult, if not impossible to control.

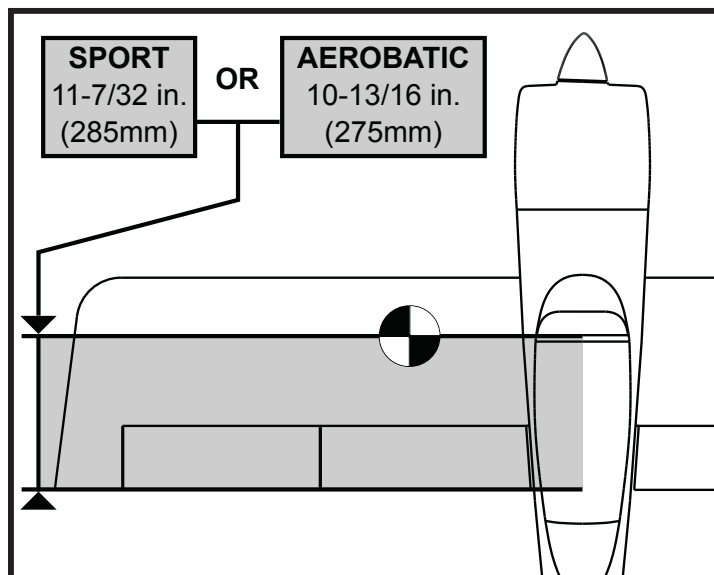

⚠ NOTICE

The CG measurement should be made with the completed airframe with all components (batteries, servos, receiver, linkages, screws, bolts, hardware, etc.) installed. Failure to do so will result in inaccurate measurement.

PRE-FLIGHT CHECKLIST

To help ensure a successful first flight, as well as many flights after, perform a few simple pre-flight checks to be sure the aircraft is ready to fly:

1. Verify the elevators and rudder are properly hinged and in good working order. Pinch a control surface between your thumb and forefinger and grasp the stabilizer with your other hand. Attempt to move the control surface back and forth perpendicular to the stabilizer (see Figure 1). Watch the hinges for movement. If you find any loose hinges, apply Foam-Cure or 15/30 minute Epoxy, being sure to stay away from the hinge pivot, to the loose side(s) of the hinge(s) and re-insert into its location. **DO NOT apply thin CA to pin hinges!** Ensure that the hinge moves freely.
2. Verify the flaps and ailerons are properly hinged and in good working order. Pinch a control surface between your thumb and fore finger, and grasp the wing with your other hand. Give the control surface a firm pull away from the wing. The control surface should not come unhinged from the wing. Be sure to avoid over-stressing the part, as an aggressive pull may cause the surface to come unhinged even though it is hinged properly. If hinging is loose, do not fly. To re-secure wing hinges, apply Thin CA, being sure to stay away from the hinge pivot, to the loose side(s) of the hinge(s) and re-insert into its location. Ensure that the hinge moves freely.
3. Verify all control surfaces move freely when disconnected from the servo. If you have a tight or binding surfaces that use pin hinges, apply a small drop of light oil to each hinge pivot. Move the surface back and forth to work the oil into the hinge. Repeat as needed.
4. Verify that all hardware and other aircraft parts are properly secured, including those connections that require blue thread lock. This includes hardware and parts installed by the factory.
5. Verify your battery is fully charged and in good condition. Avoid using batteries with swollen cells, or batteries that do not charge back to their full capacity.
6. Verify that the CG is in the proper location and that the battery is secured in place.
7. Ensure the Aura is on and functioning properly. Power on your transmitter, followed by the aircraft. Ensure the Aura is calibrated properly and receiving a valid radio source (solid orange+solid green LEDs).
8. Verify transmitter stick inputs result in the proper control surface movements (reference page 21) and the Aura flight modes work properly.
9. Verify aircraft movement results in proper Aura sensor corrections (reference page 22).
10. Verify the motor and ESC function properly. Point the aircraft in a safe direction. Hold the airframe firmly, smoothly advance the throttle to full and back to idle. Listen and watch for any odd or unusual behavior for the motor or speed controller.

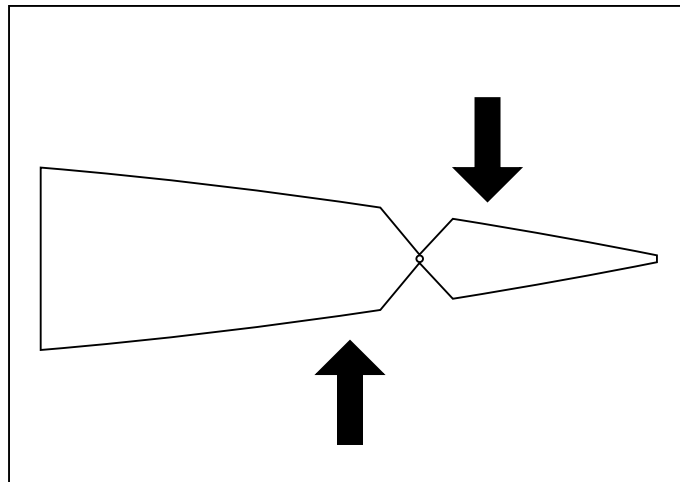

Figure 1 - Test for hinge movement and loose hinges

AMA SAFETY CODE

When flying your aircraft, we recommend following the guidelines set by the Academy of Model Aeronautics (AMA). You can find their safety handbooks as well as more information on the AMA at their website, located at the address below:

www.modelaircraft.org



RV-8 60E G2 AURA OPTIONAL FEATURES CONFIGURATION

The Aura installed in your RV-8 60E G2 comes with the Quick Set feature. Quick Set allows the pilot to adjust options in the Aura without the use of a computer. The options of the RV8 60E G2 are described below:

- Gyro Gain Kill switch: A switch can be used to immediately kill the Gyro Gain in case of emergency such as the Aura becoming unmounted in the aircraft.
- Crow Mode switch: A switch can be used to activate Crow Mode (sometimes called Butterfly) during any Flight Mode. Crow Mode simultaneously deflects the ailerons up and the flaps down to act as air brakes. The crow configuration is inversely proportional to throttle so that full crow deflection at 0% throttle reducing to zero crow deflection at 50% throttle .

To use both of these features, you will need a minimum 8 channel transmitter. If you wish to have a switchable Night LED setup, with crow, you will need a minimum 9 channel transmitter with the 9th channel enabled on your receiver .

RV-8 60E G2 Optional Feature Transmitter Setup

CH 7 (Aux 2) | Gyro Kill Switch (Optional) → Assign to 2-position switch

CH 8 (Aux 3) | Crow Switch (Optional) → Assign to 2-position switch

Flight Modes are as described in the table on page 15

Quick Set Procedure

Step 1 - Enter Quick Set Mode

1. Make sure all power is off on the RV-8 60E G2
2. Remove the prop before making changes
3. Turn on your transmitter
4. Remove the Servo lead from Aura Port S2.
5. Install a bind plug in Aura Port S2.
6. Plug in the motor battery to power up the RV-8 60E G2
7. After entering the Quick Set mode, the Orange LED will be off and the Green LED will be on SOLID. Initially the Blue and Red LEDs will also be off.

Step 2 - Choose Profile

After entering Quick Set mode as described above, you toggle the Gyro Gain Kill switch (CH7) and/or Crow Mode switch (CH8) on the transmitter to enable or disable the different options.

8. If you want to activate the Gyro Gain Kill switch, toggle the CH7 switch on your transmitter .
 - If the Blue LED is ON, the Gyro Gain Kill switch is ENABLED .
 - If the Blue LED is OFF, the Gyro Gain Kill switch is DISABLED .
9. If you want to activate the Crow Mode switch, toggle the CH8 switch on your transmitter .
 - If the RED LED is ON, the Crow Mode switch is ENABLED .
 - If the RED LED is OFF, the Crow Mode switch is DISABLED .

Step 3 - Saving your Selections

10. After setting the Gyro Gain Kill and Crow Mode options as desired, remove the bind plug to save your settings. The Blue, Green, and Red LEDs will briefly turn on while the Aura is saving, the return to their previous state .
11. Completely power off the RV-8 60E G2 and Aura
12. Replace the Servo Lead in Aura Port S2
13. Power up and Fly as usual with your new Aura Profile!

Note: This process can be repeated as many times as desired to enable or disable Gyro Kill and/or Crow Mode.

FLYING YOUR RV-8 60E G2

Selecting a Flying Site

Selecting a flying site is critical to a successful flight. Airplanes require a lot more room than other R/C products, therefore, a neighborhood or parking lot is less than ideal. A large open field with short grass and generous overfly area are the best candidates if no AMA field is available in your area. Know your overfly area - ensure that there are no houses, playgrounds, or other buildings that may be damaged if the airplane were to crash.



Takeoff

Taxi or place the aircraft on the runway centerline, with the nose pointed into the wind. Select Flight Mode 2, then set throttle trim so that the motor spins at its lowest RPM without stopping. For the first flight, leave the flaps in the up position. Smoothly advance the throttle to full while maintaining directional control with the rudder and slight back pressure on the elevator. The airplane should lift off smoothly before the throttle is fully open. Fly in Flight Mode 2 until the aircraft is fully trimmed (see special trimming instructions), and you are comfortable with its handling, then explore the other modes as desired.

Flying

Altitude is your friend on the first flight. Briskly climb to a safe altitude and trim the airplane out. The airplane should fly straight and level at 2/3 to 3/4 power with no hands on the transmitter. Try some basic maneuvers, and slowly progress into the airplane's flight envelope as you become more comfortable with the airplane's flight qualities and perfect your setup. Note: If at any time you experience unexpected control system inputs or oscillations, switch to Flight Mode 1 and reduce speed immediately, land and troubleshoot the issue.

Landing

Be mindful of your flight time and allow adequate battery reserve for a couple of go-arounds, if necessary, on the first few flights. Select Flight Mode 2 and slow the airplane and align with the runway, into the wind. For your first landing, leave the flaps in the up position. The airplane should descend smoothly in this configuration with proper airspeed. Once you are close to the ground, gradually close the throttle fully and begin to smoothly apply up elevator as required to arrest descent and the airplane should gently touch down with a short roll out.

CAUTION

USE CAUTION WHEN FLYING YOUR RV-8 60E G2 IN MODE 3 AT HIGH AIRSPEEDS. DOING SO WILL INDUCE CONTROL SURFACE OSCILLATIONS AND MAY CAUSE A CRASH.

Trimming

The first several flights on your new RV-8 60E G2 should be dedicated to trimming and setup. Fly the airplane at 2/3 power in Flight Mode 2 and trim for level flight. **DO NOT CHANGE FLIGHT MODES. Land, adjust linkages or execute Quick Trim (see below) and return the trim and/or sub-trim to zero and fly again. Repeat process until the airplane flies hands off, straight and level.**

Transmitter trim or sub-trim will cause trim shifts when different flight modes are selected. To eliminate this trim shift, the model should be mechanically trimmed, or Aura **Quick Trim** may be used instead.

Aura Quick Trim

The Aura 8 features a Quick Trim Mode that eliminates the need for mechanical linkage adjustments during test flights. Aura will learn the trim values from your transmitter, and apply them to the control surfaces at power up when enabling quick trim mode.

NOTE: Quick Trim can also be used BEFORE flying to make small changes to center the control surfaces before flight.

1. Fly the airplane in Flight Mode 2 at 2/3 power. Trim the aircraft with the transmitter trimmers and land. **DO NOT CHANGE FLIGHT MODES.**
2. Power off the RV-8 60E G2. Insert a bind plug into Aura Port S3 (you will need to remove the servo lead that is currently in S3). Check the transmitter is on and re-power the Aura to enter Quick Trim.
3. Wait 5 seconds for the Aura to completely initialize. Confirm Quick Trim mode is active by checking the Blue LED is slowly flashing.
4. Remove the bind plug from Aura Port S3 to save your trim settings. The Blue LED will flash quickly after control surface trim values are stored. While the trim values are stored in Aura, they are not applied to the control surface(s) until the Aura is re-powered.
5. Remove power from the RV-8 60E G2 and center all control surface trims on the transmitter.
6. Re-install the servo that was previously removed into port S3.
7. Re-power the RV-8 60E G2. The control surfaces should be unchanged even though the trim has been centered on the transmitter.
8. Switch between other Flight Modes to ensure you do not see any changes in trim.

NOTE: QUICK TRIM MAY BE REPEATED AS NEEDED FOR FINE TUNING, OR IF CHANGES TO THE AIRCRAFT ARE MADE.

NOTE: ENSURE AILERON/ELEVATOR/RUDDER SUB-TRIMS ARE AT ZERO IN THE TRANSMITTER BEFORE FLYING FOR THE QUICK TRIM PROCESS TO WORK PROPERLY.

AIRFRAME REPAIRS

The RV-8 60E G2 is molded from durable EPO foam and is repairable with most adhesives. Similar to building and repairing wood or composite airplanes, the correct glue for a given application is critical to the repair holding and not breaking again. For major repairs, such as a broken fuselage, epoxy is preferred because it allows time to correct any misalignment. For smaller repairs, such as a cracked control surface or small chunk of material missing from the airframe, regular CA is very effective. The use of odorless (foam safe) CA is not required and not recommended on EPO foam aircraft because it takes a longer period of time to cure than regular CA and the bond tends to be weaker.

NOTE: Avoid the use of CA accelerant in repairs. It can damage paint and will weaken the bond of the glue. If CA accelerant is used, be mindful of the locations of CA to prevent premature bonding of parts, or bonding a hand or clamp to the airframe.

If a part is damaged too badly to be repaired, please refer to the table on page 3 for a complete listing of spare airframe parts.

WARNING

Note: Do not use thread locker on any metal to plastic connection including the bolts holding the push rods to the servos or the control horns (they use lock nuts and will not back out)!

Using thread locker will weaken the plastic, void your warranty, and cause your airplane to crash!

NOTICE

If a crash is imminent, fully reduce the throttle to prevent further damage to the power system and reduce energy to lessen impact damage. Never allow the propeller to contact the ground under power, even idle.

CRASH DAMAGE IS NOT COVERED UNDER ANY PRODUCT WARRANTY.

NOTE: Avoid keeping the airplane in direct sunlight when not flying. Excessive heat can damage the airplane's structure and UV damage can permanently discolor decals.

REPLACING SERVOS

Required Tools and Fasteners: #1 Phillips Screwdriver

1. Disconnect the servo from the Aura 8.
2. Unscrew the servo arm from the servo and remove the servo arm.
3. Unscrew the two servo mounting screws at each end of the servo and remove. Note that some servos may be connected to a servo extension. This extension should be left in the wing or fuselage when the servo is replaced.

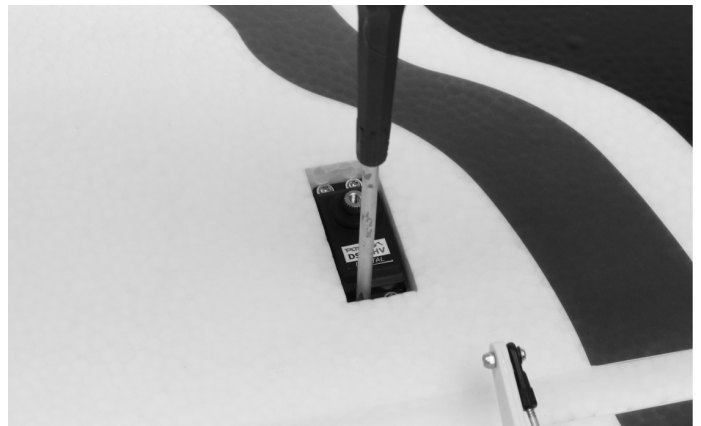
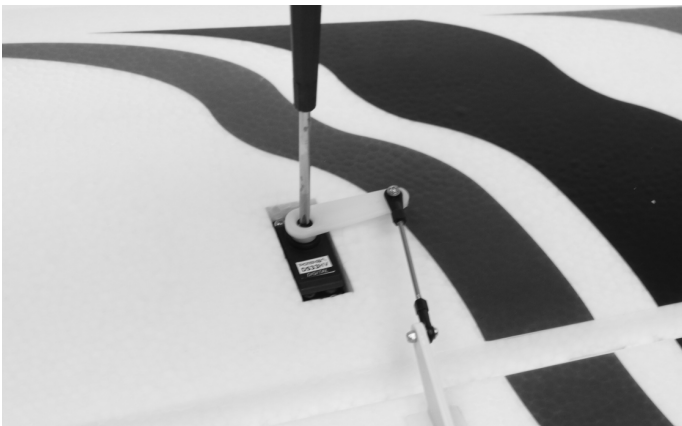

AIRCRAFT TROUBLESHOOTING GUIDE

Should you encounter any abnormal situations with your RV-8 60E G2, refer to the table below to determine the probable cause and a recommended solution for the issue. If the required solution does not rectify the problem, please contact product support at support@flexinnovations.com for further assistance.

⚠ NOTICE

Unless specifically required, ALWAYS troubleshoot the airplane with the propeller removed.

DISCREPANCY	PROBABLE CAUSE	RECOMMENDED SOLUTION
Motor non-responsive (no ESC initialization tones audible)	Throttle not at idle and/or throttle trim too high	Lower throttle stick and trim completely. If problem persists, ensure that the sub-trim and travel adjust are properly set in the radio's programming
	Motor disconnected from ESC	Ensure plugs are fully seated. Check battery and/or plugs for damage and replace any damaged components found - DO NOT ATTEMPT REPAIR
Motor non-responsive (throttle calibration tones received)	Throttle channel is reversed	Reverse throttle channel in radio programming
Motor turns in the wrong direction	The three motor wires are connected incorrectly to the ESC	Swap any TWO motor wires
Reduced flight time or aircraft underpowered	Battery not fully charged	Ensure battery is fully charged prior to installing in aircraft
	Propeller installed backwards	Install propeller so that the convex side faces forward (tractor configuration)
	Battery is too weak or damaged	Remove battery from service completely and replace with a different battery
	Ambient temperature is too cold	Ensure battery packs are adequately warm (70°F/21°C) before flight
	Battery capacity too small for intended use	Replace battery with one of proper capacity and discharge capacity
	ESC reaching preset LVC (low-voltage cutoff)	Recharge flight battery or reduce flight time
	Battery's discharge rating may be too small	Replace battery with one with higher 'C' rating
Excessive propeller noise and/or vibration	Damaged spinner and/or propeller, collet, or motor	Replace damaged components - DO NOT ATTEMPT REPAIR
	Propeller is not balanced	Balance or replace the propeller
	Prop nut is loose	Tighten prop nut with appropriate-sized wrench
	Spinner is not fully in place or tightened	Loosen the spinner bolt, adjust as required, retighten spinner bolt
	Propeller nut or propeller adapter threads not cut straight	Replace propeller nut or propeller shaft - DO NOT ATTEMPT REPAIR
Control surfaces nonresponsive	Airframe or control linkage system damage	Examine airframe for damage, repair as required; inspect control linkage system (servo, pushrod, control horn) for damaged components and replace as required
	Wire damaged or connector loose	Examine wires and connections, replace as necessary
	Transmitter bound incorrectly, incorrect active model memory, incorrect Aura data input configuration, incorrect Aura transmitter settings	Consult radio manual for proper binding and model selection instructions
	Battery voltage too low	Use volt meter to check battery; recharge or replace as necessary
	Battery disconnected from ESC	Check that the ESC plugs are fully seated
	BEC (battery elimination circuit) damaged	Replace ESC - DO NOT ATTEMPT REPAIR
	Damaged Servo	Replace Servo - DO NOT ATTEMPT REPAIR
Failed control direction test	Incorrect Aura 8 or Transmitter Setting - DO NOT FLY!	Reference transmitter and receiver sections of this manual. Refer to control surface direction chart and transmitter setup; adjust appropriate settings as required. Check RV-8 60E G2 and Aura wiki web pages for additional information. If no solution is found, contact customer support at support@flexinnovations.com
Failed Sensor Direction Test	Aura 8 is not mounted in the proper orientation	Mount Aura in the proper orientation
	Aura 8 settings incorrect	Reference the transmitter and receiver sections of this manual. If no solution is found, contact customer support at support@flexinnovations.com
Control surface oscillation	Exceeding maximum airspeed for configuration	Reduce airspeed
	Gains too high for aircraft/flight configuration	Refer to Aura 8 manual to decrease desired control surface gain
	Propeller/spinner not balanced	Balance or replace propeller and/or spinner
	Motor vibration	Inspect motor mounting bolts and re-tighten as necessary
	Loose Aura 8 mounting	Re-align and secure the Aura 8 to the aircraft
	Control linkage slop	Examine control system and repair or replace worn components
	Improper transmitter setup	Refer to Aura 8 manual to correctly configure transmitter
	Damaged propeller or spinner	Replace damaged component- DO NOT ATTEMPT REPAIR
Improperly set master gain	Ensure master gain is set for proper gain value	
Trim changes between flight modes	Trims are not properly zeroed	Readjust control linkage and re-center trims in radio
	Sub-trim is not properly zeroed	Remove sub-trim; adjust the servo arm or clevis to achieve proper geometry
	Transmitter is not properly calibrated (aileron/elevator/rudder are not neutral with sticks centered; reference transmitter monitor)	Calibrate transmitter (reference manufacturer's instructions, or return to manufacturer for calibration)
Gyro doesn't respond to aircraft movements	Note: Gyro Kill is only available after enabling it using the quick set procedure, see page 26 for details on enabling gyro kill	
	Gyro kill switch not setup on transmitter	Follow the transmitter configuration guide, assign CH7/Aux2 to a two-position switch
	Gyro kill switch in gyro off position	Move the gyro kill switch to the on position

LIMITED WARRANTY

Warranty Coverage

Flex Innovations LLC and its authorized resellers ("Flex") warrant to the original purchaser that this product (the "Product") will be free from defects in materials and workmanship at the date of purchase.

Outside of Coverage

The warranty is not transferable and does not cover:

- (a) Products with more than 45 days after the purchase date
- (b) Damage due to acts of God, accident, misuse, abuse, negligence, commercial use, or due to improper use, installation, operation, or maintenance
- (c) Damage to other components or assemblies associated with the use of the Product.
- (d) Modification of or to any part of the Product
- (e) Product not purchased from an authorized Flex Innovations dealer or distributor.
- (f) Product that has been partially, or fully assembled
- (g) Shipping damage
- (h) Cosmetic damage
- (i) Services or labor associated with the repair, use or assembly of the Product.

OTHER THAN THE EXPRESS WARRANTY ABOVE, FLEX MAKES NO OTHER WARRANTY REPRESENTATION, AND HEREBY DISCLAIMS ALL IMPLIED WARRANTIES, INCLUDING, WITHOUT LIMITATION, THE IMPLIED WARRANTIES OF NONINFRINGEMENT, MERCHANTABILITY AND FITNESS FOR A PARTICULAR PURPOSE. THE PURCHASER ACKNOWLEDGES THAT THEY ALONE HAVE DETERMINED THAT THE PRODUCT WILL SUITABLY MEET THE REQUIREMENTS OF THE PURCHASER'S INTENDED USE.

Purchaser's Remedy

Flex's sole obligation and purchaser's sole and exclusive remedy shall be that Flex will, at its option, either (i) service, (ii) replace any part of the Product determined by Flex to be defective, or (iii) replace the Product determined by Flex to be defective. Flex reserves the right to inspect all Product(s) involved in a warranty claim. Service or replacement decisions are at the sole discretion of Flex. Proof of purchase is required for all warranty claims. **SERVICE OR REPLACEMENT AS PROVIDED UNDER THIS WARRANTY IS THE PURCHASER'S SOLE AND EXCLUSIVE REMEDY.**

Limitation of Liability

FLEX SHALL NOT BE LIABLE FOR SPECIAL, INDIRECT, INCIDENTAL OR CONSEQUENTIAL DAMAGES, LOSS OF WAY, REGARDLESS OF WHETHER SUCH CLAIM IS BASED IN CONTRACT, WARRANTY, TORT, NEGLIGENCE, STRICT LIABILITY OR ANY OTHER THEORY OF LIABILITY, EVEN IF FLEX HAS BEEN ADVISED OF THE POSSIBILITY OF SUCH DAMAGES.

Further, in no event shall the liability of Flex exceed the individual price of the Product on which liability is asserted. As Flex has no control over use, setup, assembly, modification or misuse, no liability shall be assumed nor accepted for any resulting damage and/or injury. By the act of use, setup or assembly, the user accepts all resulting liability. If you as the purchaser or user are not prepared to accept the liability associated with the use of the Product, purchaser is advised to return the Product immediately in new and unused condition to the place of purchase.

Law

These terms are governed by Florida law (without regard to conflict of law of principals). This warranty gives you specific legal rights, and you may also have other rights which vary from state to state. FLEX RESERVES THE RIGHT TO MODIFY THIS WARRANTY AT ANY TIME WITHOUT NOTICE.

Questions & Assistance

Contact Us By:

E-Mail – support@flexinnovations.com

Phone – 1 (866) 310-3539

Inspection or Services

If this Product needs to be inspected or serviced and is compliant in the region you live and use the Product in, please contact your regional Flex authorized reseller. Pack the Product securely using the original shipping carton. Please note that both the inner and outer boxes need to be included. The inner box is not designed to withstand the rigors of shipping without additional protection from the outer shipping carton. Ship via a carrier that provides tracking and insurance for lost or damaged parcels, as Flex is not responsible for merchandise until it arrives and is accepted at our facility.

Warranty Requirements

For Warranty consideration, you must include your original sales receipt verifying the proof of purchase date. Provided any warranty conditions have been met, your Product or its defective parts will be replaced or serviced free of charge. Responsibility of shipping charges are as follows:

To Flex from customer, Customer is responsible.

To Customer from Flex, Flex is responsible.

Service or replacement decisions are at the sole discretion of Flex.

COMPLIANCE INFORMATION FOR THE EUROPEAN UNION



Declaration of Conformity (In accordance with ISO/IEC 17050-1)

Product(s): RV-8 60E G2 Super PNP

Item Number(s): FPM4870A

FPM4880A

FPM4870B

FPM4880B

FPM4870C

FPM4880C

The object of declaration described above is in conformity with the requirements of the specifications listed below, following the provisions of the EMC Directive 2004/108/EC.

EN 55022: 2010+AC: 2011

EN 55024: 2010

EN 61000-3-2: 2006+A2:2009

EN 61000-3-3: 2013

EN 61000-6-3: 2007/A1:2011

EN 61000-6-1: 2007



Instructions for disposal of WEEE by users in the European Union

This product must not be disposed of with other waste. Instead, it is the user's responsibility to dispose of their waste equipment by handing it over to a designated collections point for the recycling of waste and electronic equipment. The separate collection and recycling of your waste equipment at the time of disposal will help to conserve natural resources and ensure that it is recycled in a manner that protects human health and the environment. For more information about where to drop off your waste equipment for recycling, please contact your local city office, your household waste disposal service or where you purchased the product.

Enjoy your Flex Innovations RV-8 60E G2!

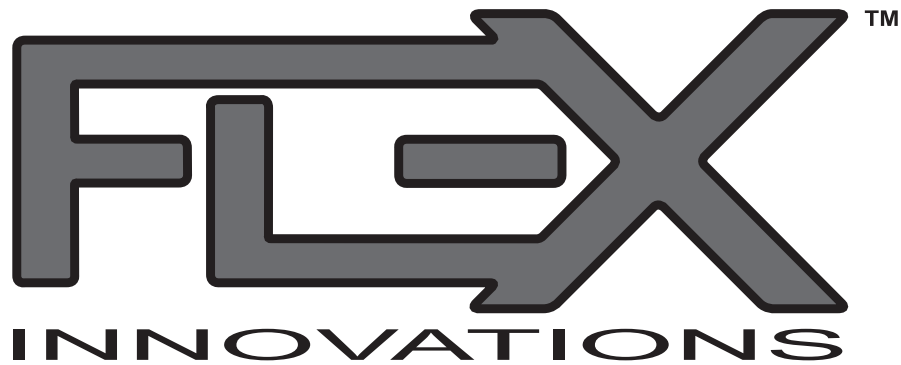

www.flexinnovations.com

© 2023 Flex Innovations, LLC. All rights reserved.

Potenza™ is a trademarks of Flex Innovations LLC

DSM®, DSM2™, and DSMX™ are trademarks of Horizon Hobby, Inc.

Futaba is a registered trademark of Futaba Denshi Kogyo Kabushiki Kaisha Corporation of Japan.

Jeti, UDI, and Jeti Model are trademarks or registered trademarks of Jelen, Ing. Stanislav of Czech Republic

HoTT is a registered trademark of SJ, Inc.