

QQ YAK 55 10E



DESIGNED BY

Giuseppe Tompazini

SUPER PNP
Instruction Manual

FLEX[™]
INNOVATIONS
www.flexinnovations.com



BEFORE CONTINUING WITH THIS INSTRUCTION MANUAL OR ASSEMBLY OF YOUR QQ YAK 55 10E SUPER PNP, PLEASE VISIT OUR WIKI SUPPORT SITE FOR THE LATEST PRODUCT UPDATES , FEATURE CHANGES, MANUAL ADDENDUMS AND FIRMWARE CHANGES FOR BOTH YOUR QQ YAK 55 10E SUPER PNP AND THE INSTALLED AURA 8 ADVANCED FLIGHT CONTROL SYSTEM.

wiki.flexinnovations.com/wiki/QQYak5510E

wiki.flexinnovations.com/wiki/Aura

TABLE OF CONTENTS

Introduction.....	2	Connecting Your Receiver to Aura	13
Includes/Requires	2	Connecting Battery/Arming ESC	14
Specifications	3	ESC Throttle Calibration	14
Replacement Parts Listing	3	Connecting a Battery to the LED Controller (Night Version Only) ...	15
Optional Items	3	Linkage Setup	15
Completion Items	3	Rudder and Elevator Linkage Installation	16
Battery Charging Guidelines.....	3	Control Direction Test	17
Special Language Definitions.....	4	Aura Sensor Direction Test	18
Important Information Regarding Warranty.....	4	Prop Adapter, Propeller and Spinner Installation	19
Safety Warnings and Precautions.....	4	Battery Installation.....	20
Low Voltage Cutoff	4	Center of Gravity.....	20
Main Landing Gear Installation.....	5	Pre-Flight Checklist.....	21
Tailwheel Installation.....	7	AMA Safety Code	21
Vertical Stabilizer Installation	8	Flying Your QQ Yak 5510E Super PNP.....	22
Horizontal Stabilizer Installation	9	Airframe Repairs	23
Main Wing Installation.....	10	Replacing Servos	23
Aura 8 AFCS	11	Aircraft Troubleshooting Guide.....	24
Transmitter Setup.....	12	Limited Warranty	25
Receiver Installation	12	Compliance Information for the European Union.....	25
Servo Connections.....	13		

INTRODUCTION

Having designed and flown hundreds of Yak variants over the years, it is pretty evident that F3A and 3D World Champion Quique Somenzini is what many consider the Yak expert. Using his extensive knowledge of the Yak platform, Quique has designed a new Yak that further advances the performance of the popular line of aerobatic aircraft. Just like the full-size Yak 55, the QQ Yak 55 10E has an incredibly versatile aerobatic envelope. From insane XA flying, to old school low and slow 3D, the QQ Yak 55 10E brings aerobatic performance that is sure to please every level of pilot.

The QQ Yak 55 10E includes the Aura 8 Advanced Flight Control System (AFCS), which is the most highly refined 3-axis gyro on the market! The Aura 8 AFCS comes pre-configured and will make the aircraft fly like it is bigger and flying in less wind. Due to its advanced programming, it is unobtrusive, feeling like there is nothing in the way of the pilot.

The QQ Yak 55 10E includes the revolutionary 6S Raw Power System, delivering some serious horsepower. Couple that with an airframe that is rigid, yet lightweight and designed by world-renowned “Yakspert” Quique Somenzini, and you get an outstanding aerobatic performer. From mild to wild 3D, the QQ Yak 55 10E delivers effortless performance, that is sure to quickly become your new favorite flyer.

- Extreme 3D and XA performance while remaining lightweight and friendly at all speeds
- New 6S Raw Power system for more power and more flight time
- Designed by F3A and 3D World Champion, Quique Somenzini
- Aura 8 Advanced Flight Control System enhances the flight without ever feeling intrusive. It's more than a gyro!
- Huge quick release top hatch for easy battery and equipment access
- (4) High-Voltage DS17HV servos installed, which provide incredible torque and speed for a more connected feel on the sticks
- Ball linkages utilized for secure and precise control
- Traditional-style hinges offer free movement and great reliability over other hinging methods
- Optional Night Version includes internally mounted LEDs in the wings, fuselage, and stabilizers to illuminate the aircraft from the inside
- Flex 12 x 5E light weight, wood propeller provides excellent thrust and fast throttle response
- Two-piece wings secure with a single thumb screw to make installation and removal super simple
- Removable horizontal stabilizers are secured with a single screw for easy storage or transport
- Potenza 20-3D 600Kv motor is optimized for 6S (22.2V) Li-PoS and XA/3D aerobatics
- 6061-T6 aluminum landing gear
- Shark tooth leading edges provide better aileron control and help reduce tip stalls and wing rock in high-alpha flight
- Innovative plywood sub-frame and hollow EPO construction keeps the structure rigid, yet lightweight
- ZTW 50A ESC with 7.4V, 5A BEC included

INCLUDES

- QQ Yak 55 10E Super PNP airframe with decals applied
- Aura 8 Advanced Flight Control System (programmed and ready to use)
- Potenza 20-3D 600Kv Brushless Motor
- 50A ZTW ESC with 7.4V 5A BEC
- (6) Potenza DS17HV Digital Sub-Micro Servos

REQUIRES

- 6+ Channel computer transmitter
- 6S 1300mAh - 1800mAh 45C+ Li-Po Battery
- Serial-Capable receiver
- 6S Li-Po capable battery charger

SPECIFICATIONS

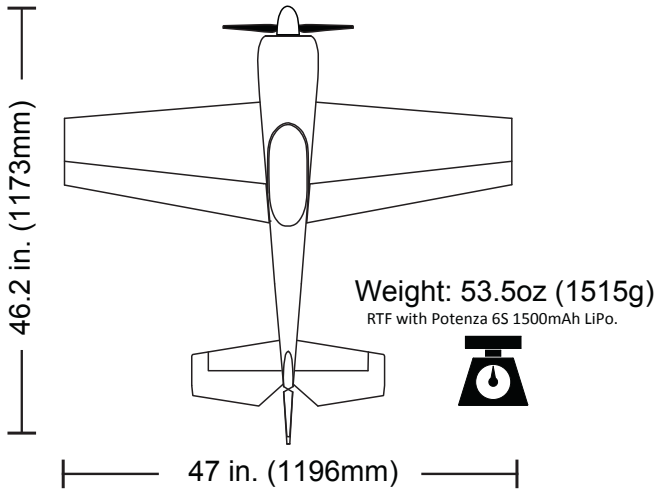

Recommended battery – 1300mAh-1800mAh 6S 45C+ Li-Po

REPLACEMENT PARTS LISTING

FPM467001	QQ Yak 55 10E Super PNP: Fuselage
FPM467002L	QQ Yak 55 10E Super PNP: Left Wing Panel
FPM467002R	QQ Yak 55 10E Super PNP: Right Wing Panel
FPM467003	QQ Yak 55 10E Super PNP: Horizontal Stabilizer Set
FPM467004	QQ Yak 55 10E Super PNP: Canopy/Hatch
FPM467005	QQ Yak 55 10E Super PNP: Aluminum Landing Gear
FPM467006	QQ Yak 55 10E Super PNP: Wheel Pant set w/Wheels, Axles & Tail Gear
FPM467007	QQ Yak 55 10E Super PNP: Wing & Stab Tube Joiner
FPM467008	QQ Yak 55 10E Super PNP: Pushrod set
FPM467009	QQ Yak 55 10E Super PNP: Pink/Black Decal Set
FPM467010	QQ Yak 55 10E Super PNP: Red/blue Decal Set
FPM467011	QQ Yak 55 10E Super PNP: Hardware Package
FPM467015	QQ Yak 55 10E Super PNP: Rudder
FPM467019	QQ Yak 55 10E Super PNP: Aileron Servo Extension Cord (pair)
FPM4670A	QQ Yak 55 10E Super PNP: Super PNP Pink/Black
FPM4670B	QQ Yak 55 10E Super PNP: Super PNP Red/blue
FPM468001	QQ Yak 55 10E Super PNP: Fuselage with night LED
FPM468002L	QQ Yak 55 10E Super PNP: Left Wing with Night LED
FPM468002R	QQ Yak 55 10E Super PNP: Right Wing with Night LED
FPM468003	QQ Yak 55 10E Super PNP: LED Light Horizontal set..
FPM4680A	QQ Yak 55 10E Super PNP: Super PNP Pink/Black Night
FPM4680B	QQ Yak 55 10E Super PNP: Super PNP Red/Blue Night
FPZM10203D	Potenza 20-3D 600kv BL Motor
FPZM10203D1	Potenza 20-3D Bolt-on Prop Adapter 20 3D
FPZM10203D2	Potenza 20-3D Bolt Aluminum X-Mount 20 3D
FPZM10203D3	Potenza 20-3D Bolt Motor Shaft 20 3D
FPMPF1205EW	Flex Innovations 12x5 Wood 2 Blade Propeller for Electric
ZTW50ABEC	ZTW 50A ESC 3s/6s w/ 5A 7.4V BEC
FPZDS17HV	Potenza DS17HV Digital Sub-Micro Servo
FPZAURA08ZZYAK55	Aura 8 for Yak55
FPZA1016	Potenza Advanced R/C LED Controller (6S)

OPTIONAL ITEMS

FPZB18006S45	Potenza 6S 1800mAh 45C Li-Po Battery
FPZB15006S45	Potenza 6S 1500mAh 45C Li-Po Battery
FPZB15006S100	Potenza 6S 1500mAh 100C Li-Po Battery
FPZB5003S25	Potenza 3S 500mAh 25C Li-Po Battery
ISDTD2	ISDT D2 200W AC/DC Charger
FPZA1010	Potenza Digital Battery Analyzer
FPZRRD1	FLEX DSMX-Compatible, diversity remote receiver
FUTT6K	Futaba T6K Transmitter with R3006SB Rx Mode 2
FUTR2001SB	Futaba R2001SB SFHSS SBUS
SPM4651T	Spektrum DSMX SRXL2 Serial Receiver with Telemetry

COMPLETION ITEMS

INSTALLED!		Potenza 20-3D 600 Kv Brushless Outrunner Motor (FPZM10203D)
INSTALLED!		ZTW 50A ESC with 5.5V/8A SBEC (ZTW50ABEC)
INSTALLED!		Potenza DS17HV Digital Metal Gear Servo (FPZDS17HV)
INSTALLED!		Aura 8 Advanced Flight Control System (FPZAURA08)
INCLUDED!		Flex 12 x 5 Wood Propeller
NEEDED TO COMPLETE		6S 1500mAh 22.2V 45C Li-Po (FPZB15006S45) 6S 22.2V 1300-1800mAh 45C+ Li-Po
NEEDED TO COMPLETE		6+ Channel Computer Transmitter
NEEDED TO COMPLETE		Serial-Capable Receiver

BATTERY CHARGING GUIDELINES

! WARNING

FOLLOW ALL INSTRUCTIONS PROVIDED BY YOUR BATTERY AND CHARGER MANUFACTURER. FAILURE TO COMPLY CAN RESULT IN FIRE.

The assembly of the QQ Yak 55 10E Super PNP can be accomplished in less than **one hour**. Prior to assembling the airplane, it is advisable to charge your battery so that you are ready to begin setup upon completion of the assembly of your model.

We recommend the use of an advanced Li-Po balancing charger, such as the ISDT D2 Dual 100W Multi Chemistry AC/DC balancing charger for your batteries to get the maximum performance and lifespan from them.

Our airplanes are designed around our Potenza batteries and we recommend the Potenza 6S 1500mAh 45C Li-Po for hard core 3D or the Potenza 6S 1800mAh 45C Li-Po for 3D mixed with sport flying in the QQ Yak 55 10E Super PNP based on our extensive testing and development. This battery features an EC3 connector, so no soldering is required for use in your QQ Yak 55 10E Super PNP.

All are available online at www.flexinnovations.com and your local Flex Innovations retailer.

SPECIAL LANGUAGE DEFINITIONS

The following terms are used throughout the product literature to indicate various levels of potential harm when operating this product:

- NOTICE:** Procedures, which if not properly followed, create a possibility of physical property damage AND a little or no possibility of injury.
- CAUTION:** Procedures, which if not properly followed, create the probability of physical property damage AND a possibility of serious injury.
- WARNING:** Procedures, which if not properly followed, create the probability of property damage, collateral damage, and serious injury OR create a high probability of serious injury.

WARNING

AGES 14+

This product is not intended for use by children under 14 years without direct adult supervision.

ATTENTION

Read the ENTIRE instruction manual to become familiar with the features of the product before operating. Failure to assemble or operate the product correctly can result in damage to the product, personal property, and cause serious or fatal injury.

All instructions, warranties and other collateral documents are subject to change at the sole discretion of Flex Innovations, LLC. For up-to-date product literature, please visit our website at www.flexinnovations.com and click on the QQ Yak 55 10E Super PNP and Aura 8 product pages.

IMPORTANT INFORMATION REGARDING WARRANTY

Please read our Warranty and Liability Limitations section before building this product. If you as the Purchaser or user are not prepared to accept the liability associated with the use of this Product, you are advised to return this Product immediately, in new and unused condition, to the place of purchase.

SAFETY WARNINGS AND PRECAUTIONS

Protect yourself and others by following these basic safety guidelines.

1. This manual contains instructions for safety, operation and maintenance. It is essential to read and follow all the instructions and warnings in the manual, prior to assembly, setup or use, in order to operate correctly and avoid damage or serious injury.
2. This model is not a toy, rather it is a sophisticated hobby product and must be operated with caution and common sense. This product requires some basic mechanical ability. Failure to operate this product in a safe and responsible manner could result in injury or damage to the product or other property.
3. This model must be assembled according to these instructions. Do not alter or modify the model outside of these instructions provided by Flex Innovations, LLC, as doing so may render it unsafe and/or un-flyable. It is your responsibility to ensure the airworthiness of the model.
4. Inspect and check for the correct operation of the model and all its components before every flight.
5. If you are not an experienced pilot or have not flown a high-performance model before, it is recommended that you seek assistance from an experienced pilot in your R/C club for your first flights. If you're not a member of a club, the Academy of Model Aeronautics (AMA) has information about clubs in your area whose membership includes experienced pilots.
6. Keep the propeller area clear from such items such as loose clothing, jewelry, long hair, or tools as they can become entangled. Keep your hands and body parts away from the propeller as injury can occur.
7. Never fly in visible moisture or submerge the airplane or any of its electronic components in water. Permanent damage to electronic components may occur, or corrosion of components may lead to intermittent failures.

LOW VOLTAGE CUTOFF

Li-Po batteries have a nominal (rated) voltage of 3.7v per cell, and fully charged, reach 4.2v per cell. Batteries are designed to be discharged below the nominal voltage, however, if they are discharged below 3.0v per cell, damage will occur and the pack will lose capacity. For best long term battery life, set a timer and land after a time that leaves approximately 15% of the battery's capacity remaining.

Low voltage cutoff is a feature that is built into the ZTW 50A ESC that is designed to protect the connected battery from being discharged too far and causing permanent damage to the cells. Circuitry within the ESC will automatically detect when the input voltage from the battery pack reaches below 3.0V per cell (average) and will remove power to the motor, but still deliver power to the servos so that a safe landing may be made. If the motor begins to lose power rapidly during flight, the LVC has sensed that the total voltage of the pack has dropped below 3.0V per cell average, and the airplane should be landed immediately.

MAIN LANDING GEAR INSTALLATION

Required Tools and Fasteners:



(QTY 2) (QTY 2) (QTY 4)

#2 Phillips Screwdriver
7mm Wrench
Needle Nose Pliers
7mm Open Wrench (optional)
Adjustable Wrench (optional)

(2) M3x14 Phillips Head Machine Screw
(2) M3x10 Phillips Head Machine Screw
(4) M3x10 Phillips Head Self-Tapping Screw
Blue Thread Lock

1. Locate the landing gear. Using blue thread lock, install the landing gear on the fuselage using a #2 Phillips screwdriver and two M3x15 screws. Mount the landing gear so that they sweep toward the nose of the aircraft, as shown in the diagram.
2. Place the landing gear cover over the landing gear as shown in the picture and secure with clear tape.
3. Locate the landing gear wheel pants. Place the inside half of the wheel pant against the outside of landing gear leg. Use a #2 Phillips screwdriver and a M3x10 machine screw to secure the wheel pant half in place. Be sure the wheel pants are oriented in the proper direction.

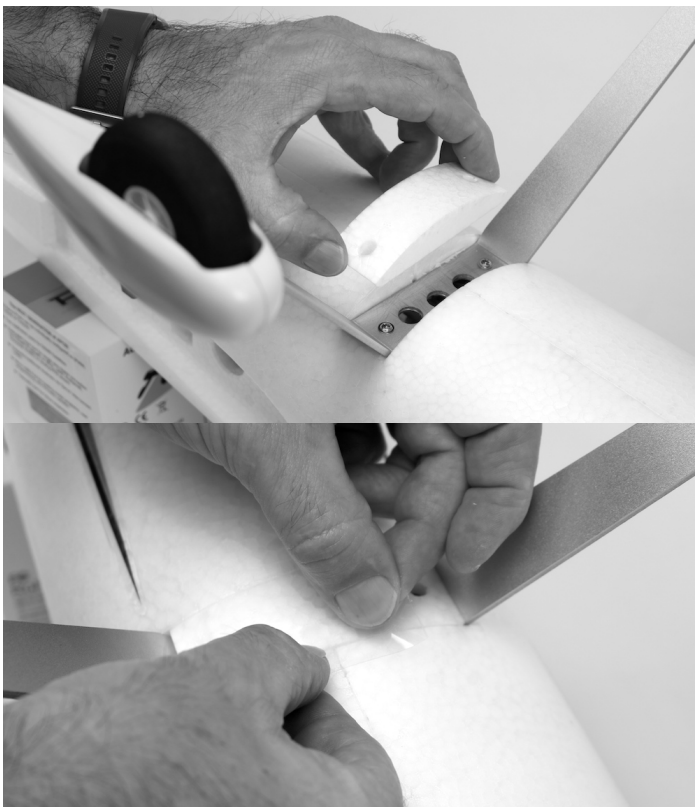
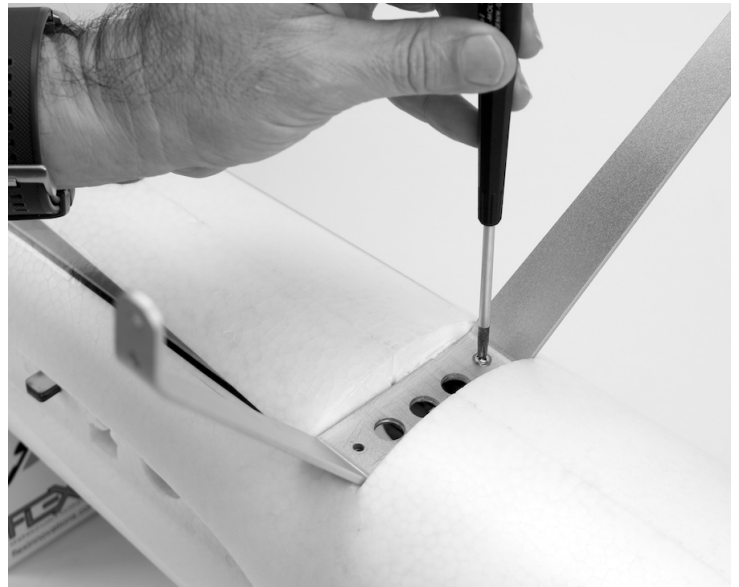
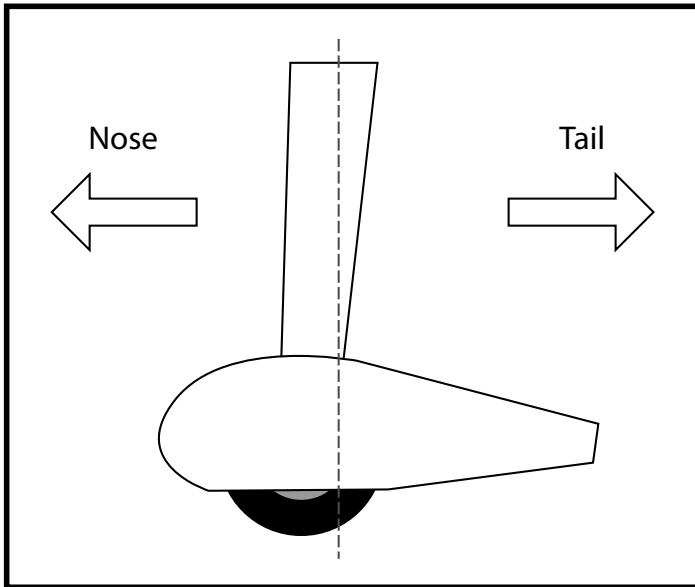

4. Locate the wheel and axle assembly. Remove the nut from the axle and insert the axle into the landing gear bracket.
5. Using needle nose pliers to hold the axle firmly, use a 7mm wrench to tighten the nut to the wheel and axle assembly.

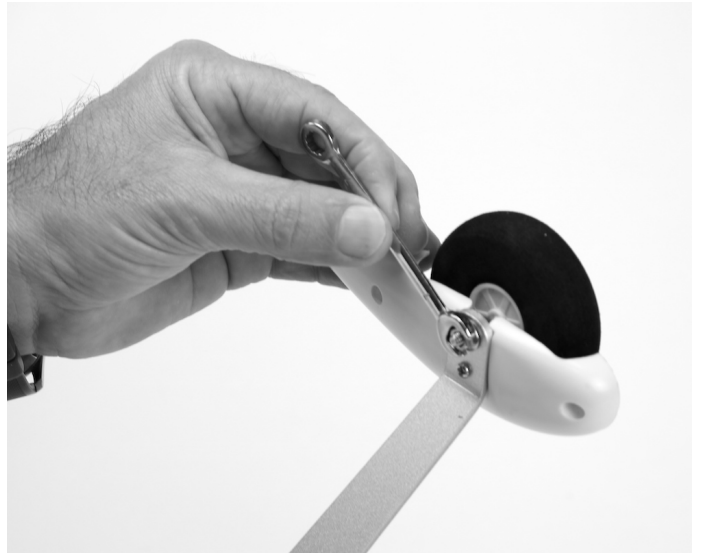
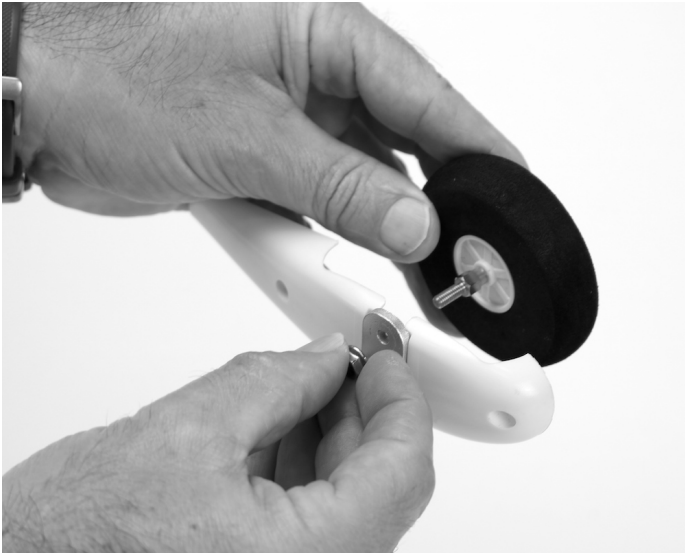

6. Fasten the outside of the wheel pants using a #2 Phillips screwdriver and two M3x10 machine screws.



TAILWHEEL INSTALLATION

Required Tools and Fasteners: #1 Phillips Screwdriver

(2) M2x8 self-tapping Phillips head cap screws

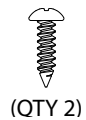

1. Locate the vertical fin assembly, tail wheel and tail wheel retaining plate. Insert the tail wheel assembly into the bottom of the rudder, being sure to orient it so that the tail wheel wire angles towards the tail as the wire moves away from the fuselage.
2. Insert the retaining plate into the cavity on the bottom of the rudder. Use a #1 Phillips screwdriver and the two M2x8 self-tapping screws to secure it in place.

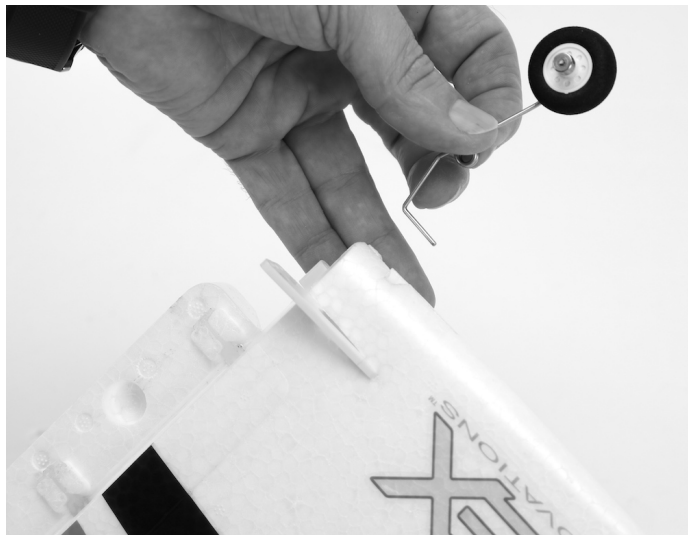

VERTICAL STABILIZER INSTALLATION

Required Tools and Fasteners: 30-Minute Epoxy
Craft Sticks (for mixing epoxy)
Mixing Cup
Paper Towels

#2 Phillips Screwdriver
(1) M3x10 Phillips Head Self-Tapping Screw
Low tack tape (e.g. blue painters tape)
CA Adhesive

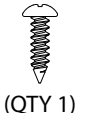

1. Find the vertical stabilizer assembly. Flex the hinge-line back and forth to ensure that it moves freely, make any adjustments as necessary. Check all the hinge points and ensure that none of them are loose or unglued. If they are add some CA adhesive, making sure that you do not get any adhesive in the hinge point.
2. Test fit the vertical fin to the fuselage, making sure everything fits properly. Make any adjustments that may be necessary. Use craft sticks and mixing cups to mix an adequate amount of 30-minute epoxy. Apply epoxy to the fuselage on all mating surfaces with the vertical fin. Be sure to avoid the three square depressions when applying epoxy so that the adhesive does not get into the hinge points.
3. Assemble the parts, being sure to wipe up any excess epoxy with a paper towel. Confirm alignment, apply some low tack tape to hold the joint in place and wait for the epoxy to cure before proceeding to the next step. This area of the airplane sees a lot of load so ensure that you use epoxy for this joint for the extra strength it provides.
4. Once the epoxy has cured, install the M3x10 rudder hinge screw using a #2 Phillips screwdriver. Deflect the rudder in both directions by hand to check movement. While checking the movement, tighten the screw until the rudder begins to bind, then loosen the screw one quarter turn.

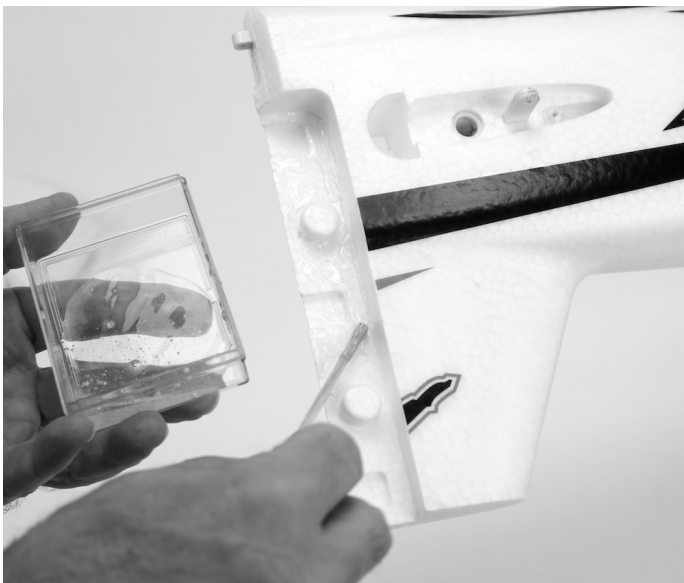
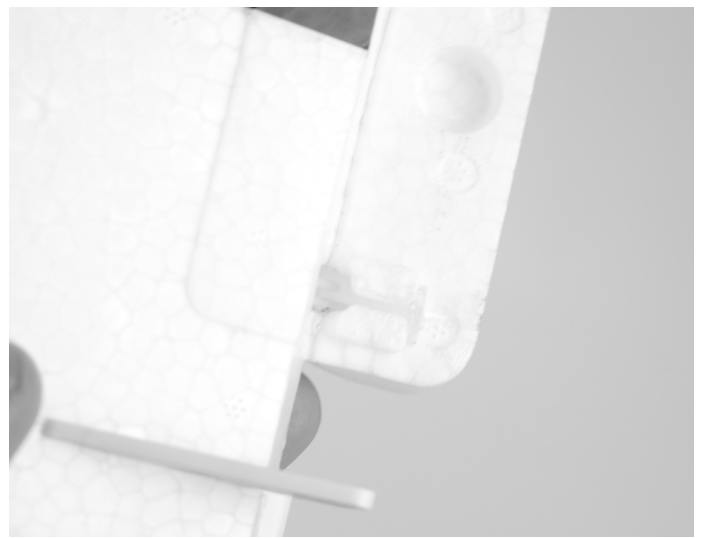
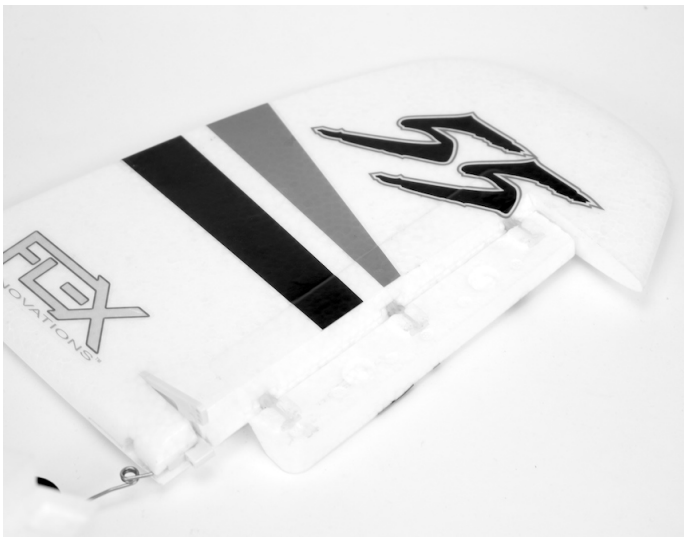

HORIZONTAL STABILIZER INSTALLATION

Required Tools and Fasteners: #2 Phillips Screwdriver

(2) M3x10 Phillips Head Self-Tapping Screw



1. Insert the horizontal stabilizer tube into the fuselage and roughly center.
2. Slide the left and right stabilizer halves onto the tube. Ensure that the control horn orients towards the belly of the airplane.
3. If you have the night version connect the LED lights in the horizontal stabilizers using the provided connectors.
4. Ensure and that the elevator joiner tabs are properly indexed and bring the two halves together. **Do not force the stabilizer into place.**
5. Use a #2 Phillips screwdriver and the two M3x10 self-tapping screws to secure each stabilizer half in place.

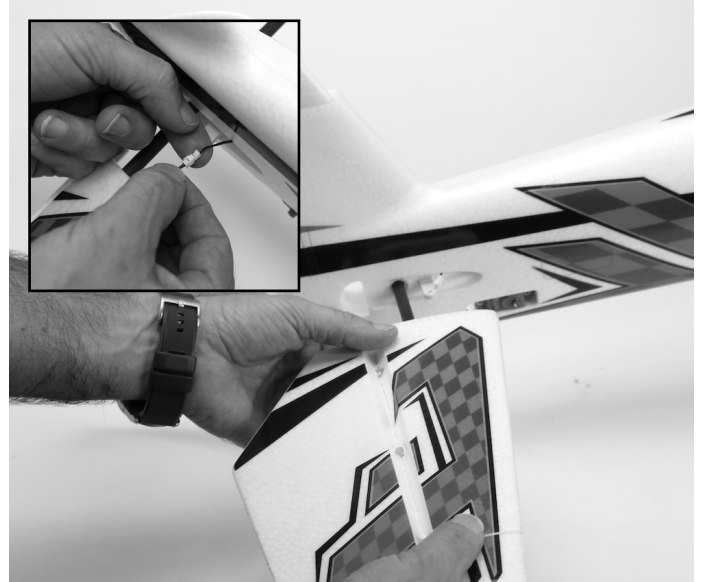

MAIN WING INSTALLATION

Required Tools and Fasteners: Medium CA Adhesive

M3x18 Thumb Machine Screw (2)



1. Find the wings and the side force generators. The rear of the side-force generator is the wide end and will line up with the ailerons.
2. Test fit the side-force generators into the wing-tips and make any adjustments as necessary. Using medium CA adhesive bond the side-force generators to the corresponding wing-tip. Wait for the adhesive to cure before proceeding to the next step.
3. Remove the battery hatch from the fuselage by pulling the spring-loaded latch tab back to release it. Lift the hatch away from the fuselage, starting at the front..
4. Insert the main wing tube into the fuselage and roughly center.
5. Slide the left and right wing panels onto the tube.
6. Fully seat the wing into the fuselage while being careful to align the wing mounting tab with the slot in the fuselage. Be sure to avoid pinching any wires during this process.
7. Secure each wing to the fuselage using an M3x18 thumb screw on the inside of the fuselage (you can use a #2 Phillips screwdriver if desired).
8. Connect the servo leads from the ailerons in the wings into the Aura, the left aileron goes into port S2 and the right aileron goes into the port S3.
9. If you have a night version, connect the wing JST to any available connector on the LED controller.

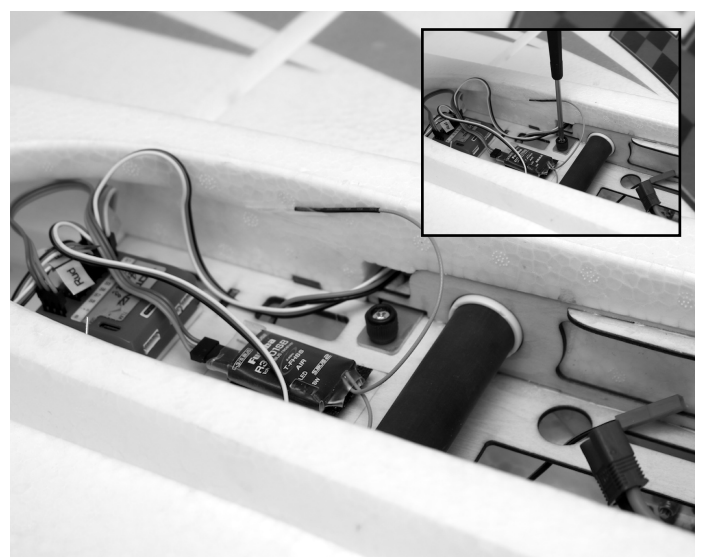
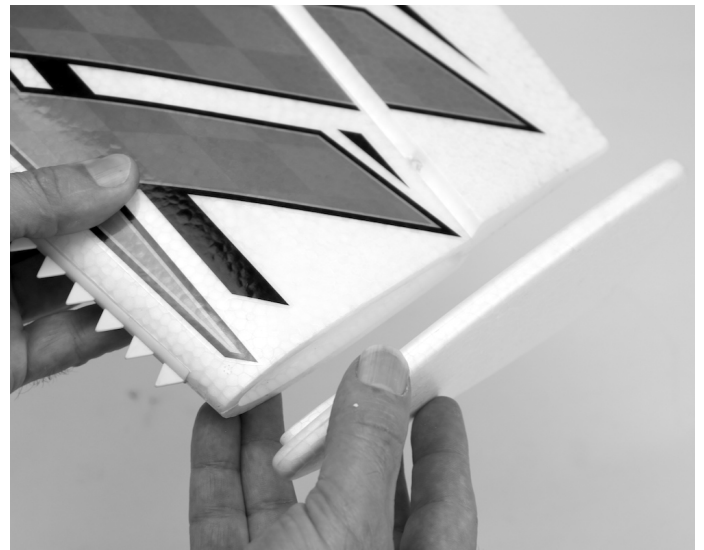

AURA 8 AFCS

The Aura 8 AFCS (Advanced Flight Control System) comes programmed and pre-installed in your QQ Yak 55 10E Super PNP, making setup a breeze. This highly-refined 3-axis gyro makes the QQ Yak 55 10E Super PNP fly like it is a larger aircraft and in less wind. Thanks to the Aura's advanced implementation, it not only enhances the flying experience, but it never interferes with the pilot's control.

The Aura 8 AFCS comes configured with Flight Modes (dual rates, expos and gyro settings) set by the Flex Innovations team, and offers a great starting point for most pilots. Since these are already configured for you in the Aura, there is no need to set up dual rates or expos in your transmitter. Simply follow the Transmitter Configuration Guide in this manual for complete details on the transmitter programming required for the QQ Yak 55 10E Super PNP and Aura 8 AFCS.

Visit wiki.flexinnovations.com/wiki/Aura for the latest Aura-related product information and updates.

Description of Pre-Configured Aura Flight Modes

Flight Mode 1: Sport

- For general flight, high speed aerobatics or test flights
- Rates are low and expos tuned for comfortable flight.
- Gyro gain¹ is set to low.

Flight Mode 2: High Speed 3D

- For high speed 3D flight.
- Rates are set very high and expos tuned for general flight.
- Gyro gain¹ is set to moderate.

Flight Mode 3: Slow Speed 3D

- For slow speed 3D flight.
- Rates are set to maximum and expos are tuned for 3D flight.
- Gyro gain¹ is set to moderately high.
- **Gyro oscillation² will occur at mid to high speeds. Do NOT fly at mid to high speeds in this Flight Mode.**

NOTE - Gyro can be disabled in any flight mode using the Gyro Kill switch assigned to Channel 6 (see table on next page).

NOTE - Rudder stick movement will also move the ailerons and elevator. This is NORMAL and is the pre-programmed mixing..

Each of the modes has been tuned by our team to offer a solid start. Because tastes in control feel are unique, if changes in rate and expo are needed adjustments should be made through Aura. Changes on gain value may only be made through the Aura.

¹ Gain: The amount of correction the gyro applies. The higher the gain, the more correction the gyro applies.

² Oscillation: Rapid and repeating movements back and forth, often extreme.

TRANSMITTER SETUP

The included Aura 8 is designed to work seamlessly with all popular transmitter and receiver brands, however, transmitter setup is significantly different than when setting up a model without Aura. Follow these steps:

1. Start with a new and freshly reset model memory in your transmitter.
2. Adjust your transmitter settings according to the Transmitter Configuration Guide below.
3. **Make ONLY the changes shown in the Transmitter Configuration Guide.** No other changes are required.

Transmitter Configuration Guide

	Spektrum, Futaba, JR ¹ & Graupner	FrSky	Jeti (EX-Bus)
Wing/Tail Type	1 Aileron, 1 Elevator, 1 Rudder	1 Aileron, 1 Elevator, 1 Rudder	1 Aileron, 1 Elevator, 1 Rudder
End Points (Travel Adjust or ATV)	Ail/Ele/Rud – 125%	Ail/Ele/Rud – 100%	Aileron/Ele/Rud – 100%
	Thro/CH5/CH6 – 100%	Thro/CH5/CH6 – 84%	Thro/CH5/CH6 – 80%
Reversing	Not Allowed²		
Sub-Trim	Verify at Zero, NOT ALLOWED		
Trim Levers	Verify at Zero		
CH5 (Gear) – Flight Mode	Assign to a 3 Position Switch		
CH6 (Aux 1) – Giro Kill	Assign to a 2 Position Switch		
First Flight Timer³	For your first flight, set to 4:00		

- 1 JR customers should use JR XBUS Mode A, and follow the chart above. This is the preferred JR DMSS connection to Aura.
- 2 If you are using a Futaba transmitter, please note that some Futaba transmitters have the throttle set to reversed by default. We recommend that you leave the reversing set to the defaults and reverse it if needed after testing. **NOTE: do all throttle testing with the prop removed!**
- 3 This time is a safe starting point for most pilots. This aircraft can typically fly anywhere between 4 and 6 minutes (with 6S 1800mAh Li-Po), depending on an individual's flying style.

FOR CUSTOMERS USING TRANSMITTERS OTHER THAN WHAT IS LISTED IN THE CHART ABOVE, PLEASE VISIT OUR WIKI PAGE FOR INSTRUCTIONS SPECIFIC TO YOUR TRANSMITTER AND RECEIVER BRAND

HITEC – wiki.flexinnovations.com/wiki/Aura/HitecSbusUse

RECEIVER INSTALLATION

Choosing a Receiver

Aura will auto-detect modern serial receiver connections. For use in the QQ Yak 55 10E Super PNP, only a serial receiver connection or a Spektrum Remote Receiver can be used. Below are a few examples of serial receivers that can be used with the Aura 8. This is not a complete list of compatible receivers, rather a short list to assist in your receiver selection.

FLEX Remote Receiver – FPZRRD1 FLEX DSMX-Compatible, diversity remote receiver

Spektrum Remote Receiver(s) – SPM9645, SPM9745 (QTY: 1 or 2)

Spektrum SRXL2 – SPM4651T, SPM4650, AR6610T

Futaba S.Bus – Futaba R7008SB, R2001SB, R6202SBW

Hitec S.Bus – Optima SL, Maxima SL

FrSky S.Bus – RX4R, RX6R

Graupner HoTT (Sum D of 8) – GR12L, GR16L

JR XBus (Mode A & Mode B) – RG012BX, RG613BX, RG821BX

Jeti EX-Bus – REX10, R9 EX, REX6

SERVO CONNECTIONS

DEFAULT AURA CONNECTIONS

- S1 – Throttle
- S2 – Left Aileron
- S3 – Right Aileron
- S4 – Elevator
- S5 – Rudder
- S6 – Empty
- S7 – Empty
- S8 – Empty

Port B – Serial Receiver Input

Mini Port A&B – Remote Receiver Inputs

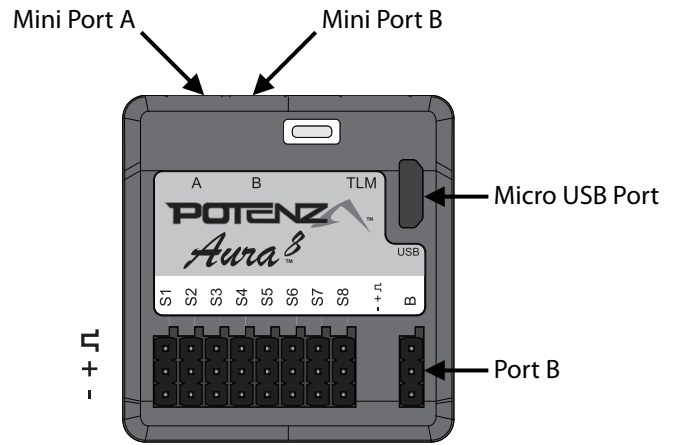

CONNECTING YOUR RECEIVER TO AURA

Spektrum Remote Receivers

If using a Spektrum Remote Receiver, connect it to Aura Mini Port A using the cable provided with your receiver. You can also choose to add a second remote receiver to Aura Mini Port B for added redundancy.

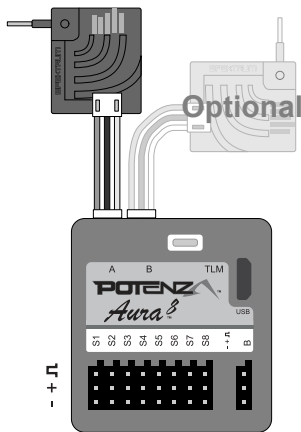

Binding Your Receiver

1. With the transmitter and aircraft powered OFF, place a bind plug into Aura Port S8.
2. Power on the aircraft. Your remote receiver should flash rapidly, indicating it is in bind mode.
3. Bind your transmitter to the remote receiver per your transmitter manufacturer's instructions. This is typically done by pressing and holding the bind button on your Spektrum transmitter while powering it on.
4. Verify the receiver is bound by looking at the LED on the Remote Receiver. This is typically indicated by a solid orange LED on Spektrum Remote Receivers.
5. Remove the bind plug from Aura Port S8.

Note: When using the Flex DSMX Compatible, Diversity Remote Receiver, only one can be used with the Aura 8; using two Flex remotes is not supported. If you wish to use two remote receivers, please use two genuine Spektrum remote receivers. See the receiver product page for more details.

flexinnovations.com/product/flex-dsmx-compatible-remote/

Serial Receivers

If using a standard serial receiver, connect the provided male to male cable to your receiver's serial port. Connect the other end of the cable to Aura Port B noting proper polarity.

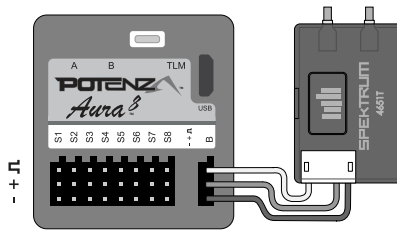

Note: The Spektrum 4651T receiver requires the use of a different cable to connect to Aura. The cable is included with the receiver when it is purchased directly from Flex Innovations. You can also purchase the cable itself at flexinnovations.com (FPZA1039).

Note: If you are using Futaba S.Bus, be sure to use the proper S.Bus port in your receiver. DO NOT use the S.Bus2 port, as it is not supported for use with the Aura 8. Refer to your manufacturer's instructions for proper S.Bus use.

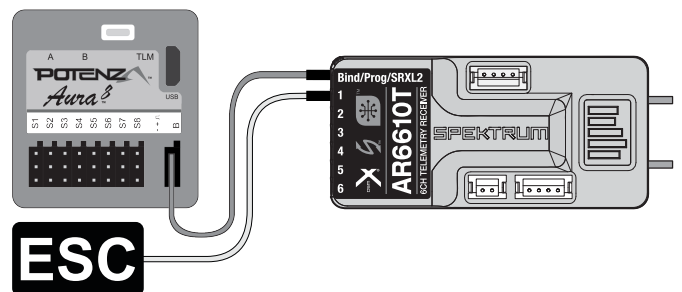
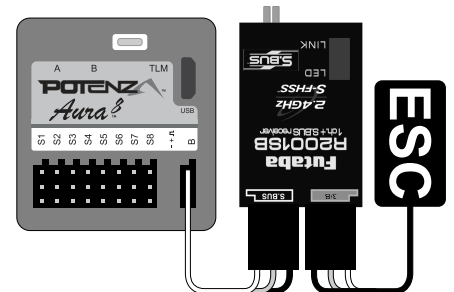

Note: If you wish to use the AR6610T with an SRXL2 remote receiver, please visit our wiki page for more details:

<https://wiki.flexinnovations.com/wiki/Aura/SpektrumUse>

Binding Your Receiver

Bind your receiver to your transmitter per your receiver and transmitter manufacturer's instructions.

CONNECTING YOUR RECEIVER TO AURA (CONTINUED)

Aura 8 Auto-Detect

Once your receiver is bound, powered, and connected to the Aura, the Aura will begin the Auto-Detect process to learn what type of receiver you are using and set itself up for that specific system. Auto-Detect is indicated by a series of sweeping LEDs of various colors. After Auto-Detect is completed, verify that Aura is on and receiving data from your receiver by looking at the LEDs on the Aura.

Ready-To-Fly:

Solid Orange LED: Aura On and Calibrated

Solid Green LED: Aura receiving Valid receiver data



Possible Errors:

Flashing Orange LED: Aura Moved During Power Up

No Green LED: Aura NOT receiving receiver data



CONNECTING BATTERY/ARMING ESC

Observe the following procedures to safely power up your model after it has been bound. **Ensure propeller is removed unless this sequence is followed to power up before flight.**

1. Turn on the transmitter. **Lower the throttle stick AND throttle trim** to their lowest settings. Be sure to wait for your transmitter to indicate it the radio signal is being broadcast before proceeding

If a battery is connected to the ESC with the throttle fully open on the transmitter, the ESC will enter programming mode. If this occurs, simply disconnect the battery, lower the throttle and reconnect the battery.

2. Ensure the aileron, elevator and rudder gimbals are centered.
3. With the airplane on a solid surface, connect the battery to the ESC and wait. The ESC will make the motor emit a series of audible tones during its initialization process.
4. The ESC will make the motor emit a short, final tone sequence indicating that the ESC is now armed and that the motor will spin in response to throttle stick movement.

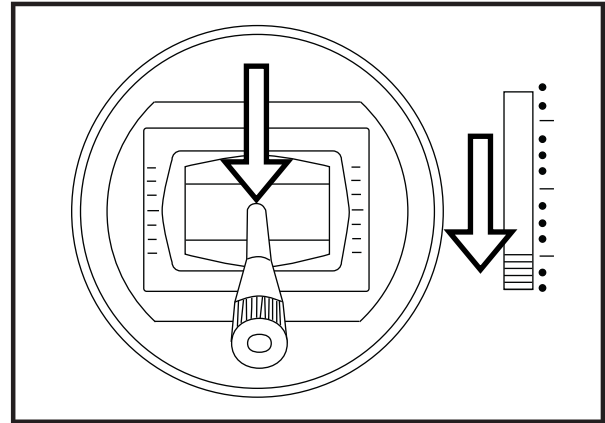

! CAUTION

Always connect the battery when the throttle stick and throttle trim are in the idle/cut-off position.

! WARNING

When making adjustments to linkages, transmitter settings, or the Aura 8 flight control system, remove the propeller to guard against accidental spool up.

! WARNING

Hold aircraft securely when connecting the battery before flight. Always ensure that the propeller is clear of any and all objects as they may become entangled.

ESC THROTTLE CALIBRATION

In order to map the full range of the ESC output to your throttle stick motion you will have to perform an ESC throttle calibration. **NOTE: Execute ESC throttle calibration with the propeller and spinner removed.**

1. Power on your transmitter, DISABLE any throttle hold or throttle kill switches, **completely lower the throttle trim** and set the stick to full throttle.
2. Connect the flight pack to your QQ Yak 55 10E Super PNP.
3. Listen for the tones coming from the ESC through the motor, after about 2 seconds you should hear two tones.
4. Pull your throttle stick back to idle.
5. Listen for the ESC arming tones from the motor.

The ESC throttle range has now been properly calibrated, and is stored in the ESC's memory until it is calibrated again. You can repeat this process as many times as necessary.

CONNECTING A BATTERY TO THE LED CONTROLLER (NIGHT VERSION ONLY)

The LEDs on your aircraft are switchable via the transmitter, and are designed to be powered by 12 volts (3S Li-Po) through the 6S JST-XH balance tab on the LED controller. **By default, the LED controller is left unplugged. If the servo lead of the LED controller is not plugged into the Aura or a receiver, the LED controller will default in the ON position when powered, allowing the Night Version to be flown at night with a basic 6-channel transmitter or receiver.**

IN ORDER TO CONTROL THE LEDS FROM THE TRANSMITTER, YOU MUST USE A STANDARD RECEIVER THAT IS CAPABLE OF 7+ CHANNELS, AND KEEPS THE SERVO PORTS ACTIVE WHEN USING A DIGITAL DATA STREAM (like S.Bus, SRXL etc.).

⚠ WARNING

You **MUST** use an independent 3S Li-Po battery to power the LEDs in the QQ Yak 55 10E Super PNP. Failure to do so can damage your flight batteries. We recommend the use of the Potenza 3S 500mAh 25C Li-Po (FPZB5003S25).

⚠ WARNING

Do not leave the battery plugged into the LED controller for extended periods of time. Doing so can damage the battery.

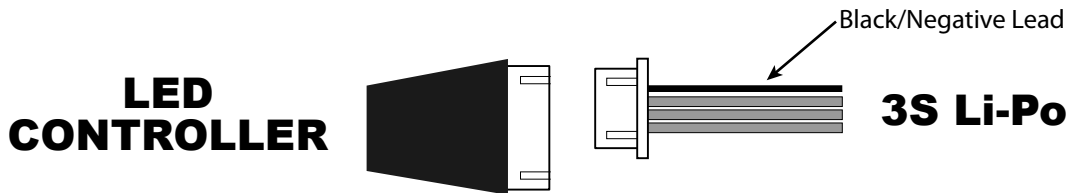

LINKAGE SETUP

Mechanically adjust the control linkages so that the surfaces are neutral with zero trim and zero sub-trim. Final trim adjustments may be required during flight. For more information on flight trimming, please refer to the trimming section located on page 22 of this manual.

Ball links are used on all control surfaces at the servo end. The stock attachment for the Ailerons is in the 3rd hole from the end of the servo arm. The stock attachment for the Elevator is in the 4th hole from the end of the servo arm. The stock attachment for the Rudder is in the 1st hole from the end of the servo arm.

Ball links are used on all control surfaces at the control horn end. The stock attachment for the Aileron and Rudder is located in the outer hole, and in the inner hole is used for the for the Elevator.

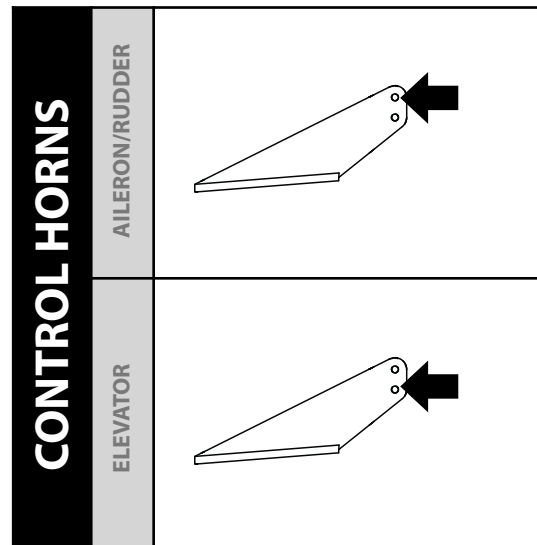
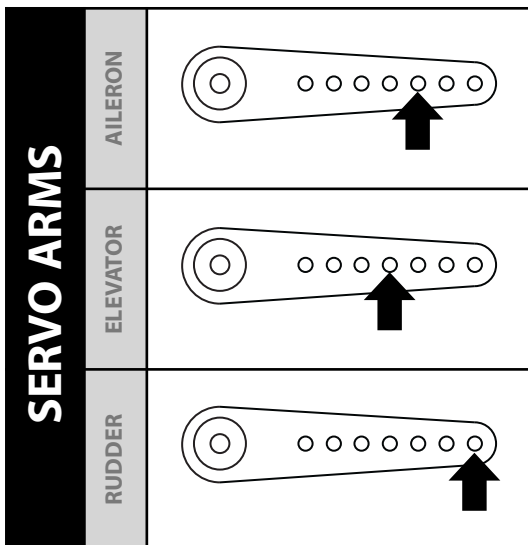

⚠ NOTICE

The DS17HV servos installed in your QQ Yak 55 10E Super PNP are high quality, digital servos with metal gear train and ultra-fine gear mesh. This fine resolution and high tooth count output shaft means that the servo arms pre-installed on the servos may inadvertently be misaligned, yet appear properly installed. It is critical to ensure the positive, perpendicular orientation of the arm to the case to ensure that the travel of the servos is even from side to side at extreme throws.

RUDDER AND ELEVATOR LINKAGE INSTALLATION

Required Tools and Fasteners:

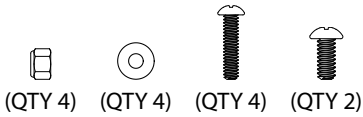

Elevator and Rudder Pushrod Assemblies
 (4) M2x10 Phillips Head Machine Screw
 (4) M2 Flat Washer
 (4) M2 Lock Nut
 (2) M3x6 Phillips Head Machine Screw

#1 Phillips Screwdriver
 #2 Phillips Screwdriver
 Needle-Nosed Pliers (or Hemostats)
 4mm Socket Hex Driver (optional)
 Blue Thread Lock

1. Locate the rudder and elevator pushrod assemblies, as well as the servo arms and hardware. Note that both pushrods and servo arms are the same length so they can be used in either position. Use the charts on the previous page as reference for the pushrod installation locations.
2. Power on your transmitter, and move your Gyro Kill switch (assigned on page 12 of this manual) to Gyro Off. Power on the airplane, and confirm the gyro is off in the Aura by rotating the airplane quickly, and verifying that you get no gyro controlled servo movement.
3. With the aircraft still powered on, install the rudder and elevator servo arms perpendicular to the servo case, being sure to orient the servo arm towards the bottom of the fuselage. Apply blue thread lock to the M3x6 Phillips head machine screw, and secure the servo arm in place using a #1 Phillips screwdriver.
4. Use a #1 Phillips screwdriver, M2x10 machine screw, M2 washer and M2 lock nut to secure the linkage to both the control horn and the servo arm. **DO NOT use thread lock, as thread lock can damage the plastic in the nut, as well as the control horn.** Note that the rudder ball link should be placed below the rudder control horn. The order of components is as follows:
 1. M2x10 Machine Screw
 2. M2 Washer
 3. Ball Link
 4. Servo Arm or Control Horn
 5. M2 Lock Nut

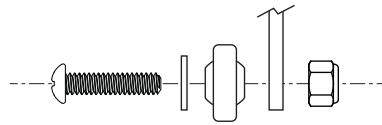

5. Repeat the process for the other control linkage.

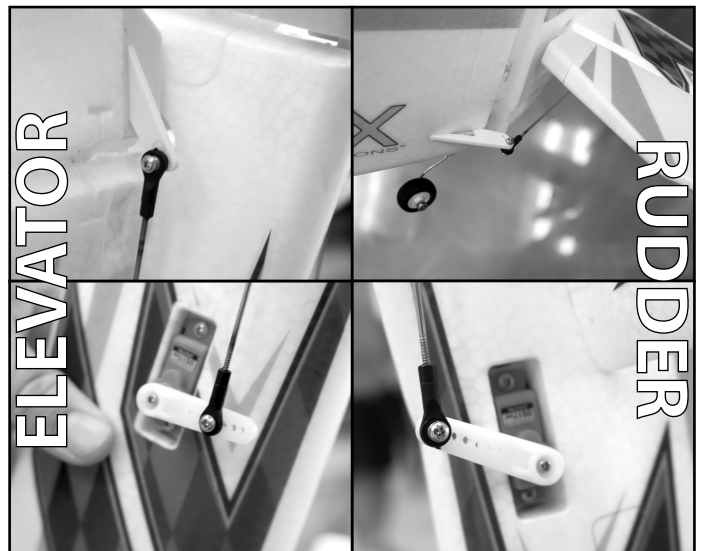
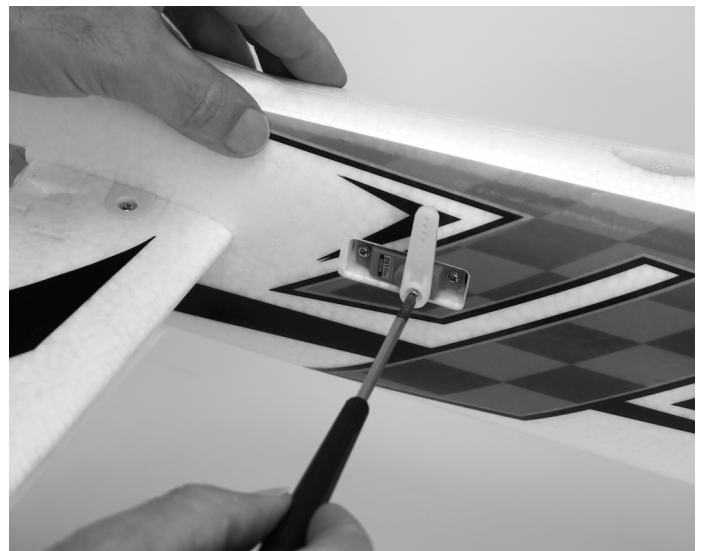
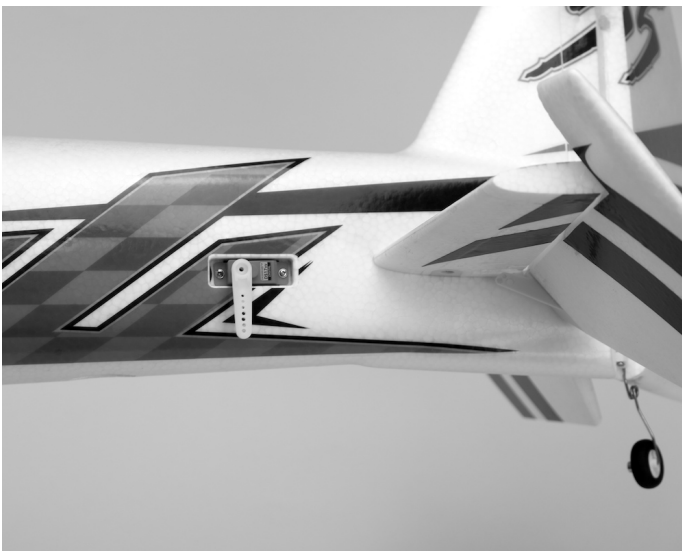

CONTROL DIRECTION TEST

Refer to the chart below to determine the proper control surface directions.

If controls are reversed, DO NOT REVERSE CONTROLS IN YOUR TRANSMITTER OR IN THE AURA CONFIG TOOL. Email us at support@flexinnovations.com for corrective action. Note that BOTH the Transmitter Control Direction Test AND the Flight Controller Sensor Direction Test MUST BE PASSED! IF EITHER ONE DOES NOT PASS, DO NOT FLY!

NOTE: There is pre-configured rudder to aileron and rudder to elevator mixing programmed into the Aura. Simultaneous movement of these control surfaces with rudder input is intentional and completely **NORMAL**.

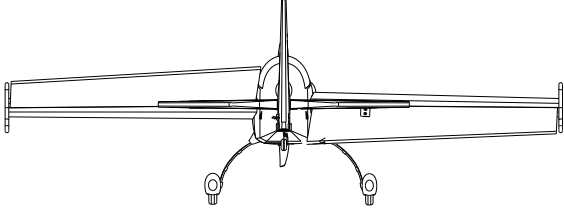
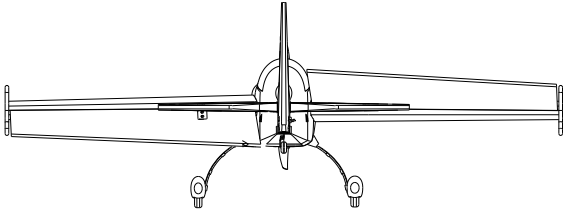
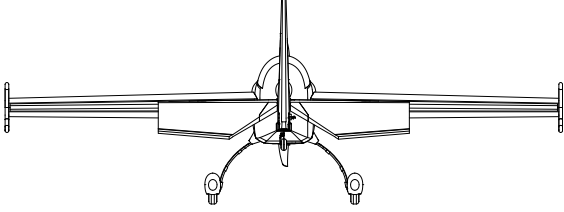
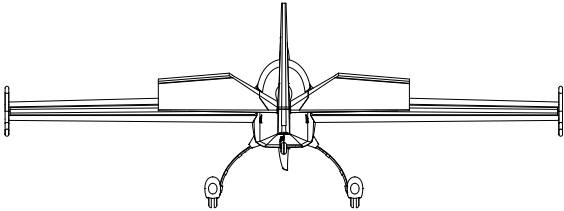
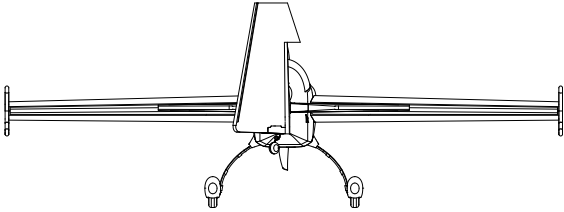
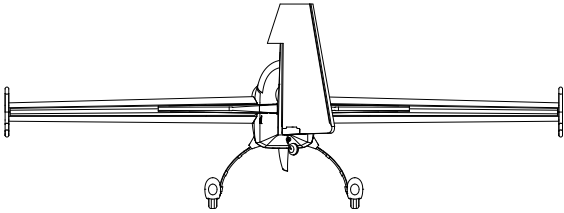
	Transmitter Command	Proper Control Surface Deflection
AILERON	Stick Left	
	Stick Right	
ELEVATOR	Stick Forward	
	Stick Aft	
RUDDER	Stick Left	
	Stick Right	

AURA SENSOR DIRECTION TEST

Perform a test of the gyro system to verify the corrections made for a given movement are correct. **If any of the tests do not result in the correct reaction from the airplane's gyro system, DO NOT FLY THE AIRPLANE, and contact us via email at support@flexinnovations.com**

The flight control system activates with RF broadcast. Perform these tests in Mode 3 (higher gain) for better visibility and then in Mode 2, and any other modes that have gyro gains assigned. (By default, Mode 1 has no gain assigned). Control surface deflections are exaggerated in the pictures below for clarity. Please note that the control surfaces will move **ONLY** while the aircraft is being **ROTATED**.

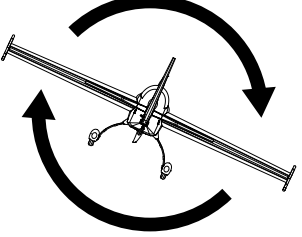
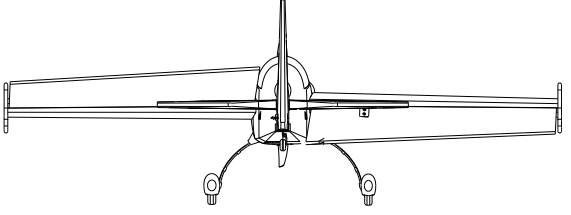
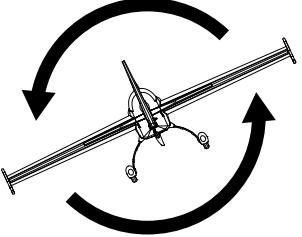
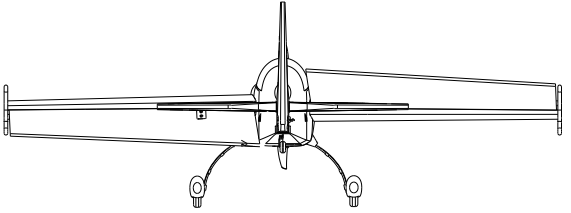
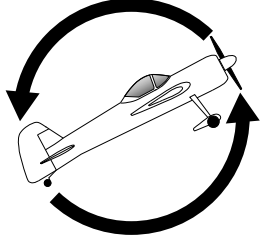
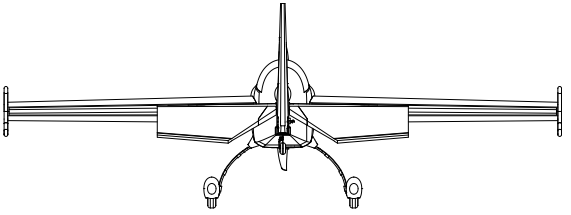
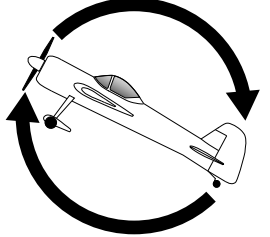
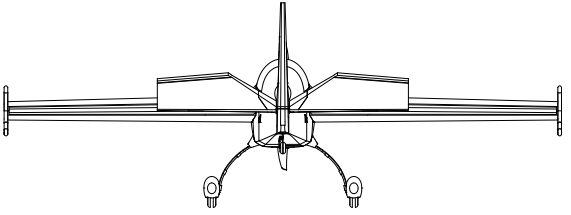
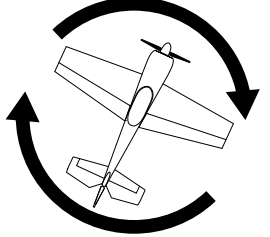
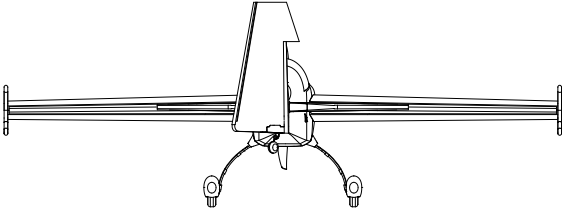
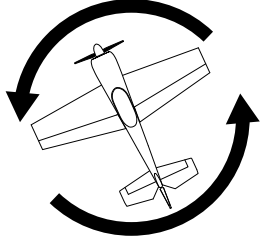
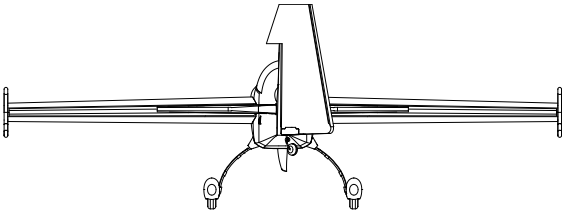
	Aircraft Movement	Proper Control Surface Deflection
AILERON		
		
ELEVATOR		
		
RUDDER		
		

PROP ADAPTER, PROPELLER AND SPINNER INSTALLATION

Required Tools and Fasteners:

2mm Hex Driver
Adjustable Wrench
Blue Thread Lock

(4) M2.5 x 8 socket head machine screws
(1) M3 x 6 button head machine screw



1. Place the prop adapter on the motor bell housing checking that the holes in the prop adapter line up with the holes in the motor bell housing. Using the 2mm hex driver, secure the prop adapter to the motor bell housing using the M2.5 x 8 socket head machine screws. Apply a small amount of blue thread lock to the screws and ensure that they are tightened fully.
2. Install the propeller on the prop adapter with the convex surface facing forward. The printing is on the front face of the prop and should orient forward.
3. Slide the prop washer on the prop adapter with the widest face aft, followed by the propeller nut. Using an adjustable wrench, tighten the propeller nut fully.
4. Slide the spinner over the prop and prop shaft and secure it using a 2mm hex driver and the M3 X 6mm machine screw.



NOTICE

Spin the motor over by hand to ensure that the prop and spinner spin smoothly and true after installation.

BATTERY INSTALLATION

1. Push the spring-loaded battery latch tab back to release the battery hatch. Lift the hatch away from the fuselage, starting at the front.
2. Install the hook side of adhesive-backed hook and loop tape to the plywood battery tray in the fuselage, and the loop side to your battery.
3. Place the battery on the tray, and secure it in place with the hook and loop strap provided.
4. Reinstall the hatch, and confirm that the latch has positively engaged.

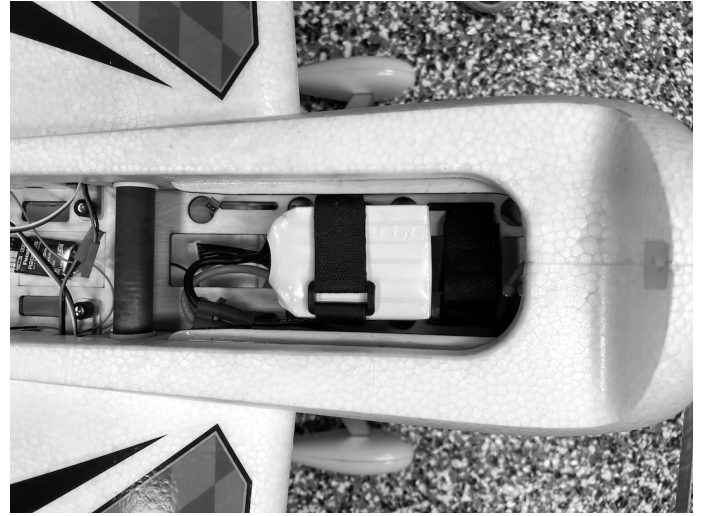

CAUTION

Always keep limbs clear from the propeller when the battery is connected. After the ESC arms, the propeller will rotate when the throttle is moved. Unlike an internal combustion engine, electric motors apply more voltage to counteract resistance, therefore any object that is entangled in the propeller will be severely damaged before the motor will stop.

WARNING

When making adjustments to linkages, transmitter settings, or the Aura 8 flight control system, remove the propeller to guard against accidental spool up.

CENTER OF GRAVITY

Setting the center of gravity (CG) is one of the most important steps for successful flight, particularly with a new airplane. The QQ Yak 55 10E Super PNP is an extremely capable airplane with large control surface throws and a high thrust to weight ratio. These factors make it an enjoyable aircraft to fly, but if the CG is not within an acceptable range, it will make the airplane difficult, if not impossible to control.

Prepare the aircraft to its flight-ready state. This means all hardware, components and flight battery should be installed before proceeding. The center of gravity (CG) is measured from the trailing edge of the main wing toward the nose of the aircraft. Lift the aircraft upright, with all components installed, from the bottom of the wing at the CG location noted.

The acceptable CG range for the QQ Yak 55 10E Super PNP is 145mm to 135mm (5 23/32 inches to 5 5/16 inches) measured **Forward, from the Trailing Edge of the wing, at the Wing Tip**. A good starting point is 140mm and you can adjust from there according to your flying style.

Designer and multi-time world champion Quique Somenzini has found 140mm be the sweet spot in the acceptable CG range based on his extensive test flights and experience.

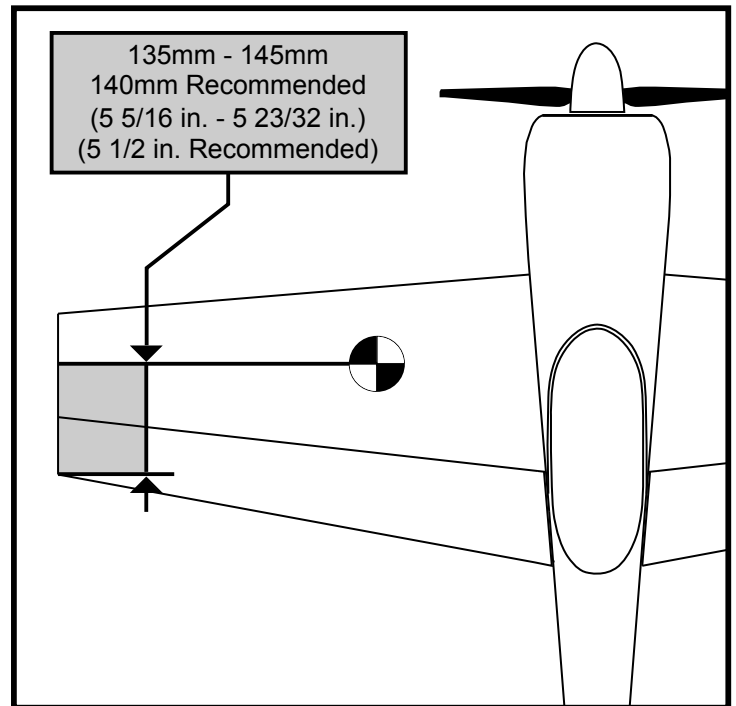

NOTICE

The CG measurement should be made with the completed airframe with all components (batteries, servos, receiver, linkages, screws, bolts, hardware, etc.) installed. Failure to do so will result in inaccurate measurement.

PRE-FLIGHT CHECKLIST

To help ensure a successful first flight, as well as many flights after, perform a few simple pre-flight checks to be sure the aircraft is ready to fly:

1. Verify all control surfaces are properly hinged. Pinch a control surface between your thumb and forefinger and stabilize the wing with your other hand. Attempt to move the control surface back and forth perpendicular to the wing (see Figure 1). Watch the hinges for movement. If you find any loose hinges, apply a small amount of medium CA to the mounting point, being sure to keep glue away from the hinge pivot. Wait 15-20 seconds, then apply CA accelerator to cure the CA.
2. Verify all control surfaces move freely when disconnected from the servo. If you have a tight or binding surface, apply a small drop of light oil to each hinge pivot. Move the surface back and forth to work the oil into the hinge. Repeat as needed..
3. Verify that all hardware and other aircraft parts are properly secured, including those connections that require blue thread lock. This includes hardware and parts installed by the factory.
4. Verify your battery is fully charged and in good condition. Avoid using batteries with swollen cells, or batteries that do not charge back to their full capacity.
5. Verify the C.G. is in the proper location and the battery is secured in place.
6. Ensure the Aura is on and functioning properly. Power on your transmitter, followed by the aircraft. Ensure the Aura is calibrated properly and receiving a valid radio source (solid orange+solid green LEDs).
7. Verify transmitter stick inputs result in the proper control surface movements (reference page 17) and the Aura flight modes work properly.
8. Verify aircraft movement results in proper Aura sensor corrections (reference page 18).
9. Verify the motor and ESC function properly. Point the aircraft in a safe direction. Hold the airframe firmly, smoothly advance the throttle to full and back to idle. Listen and watch for any odd or unusual behavior for the motor or speed controller.

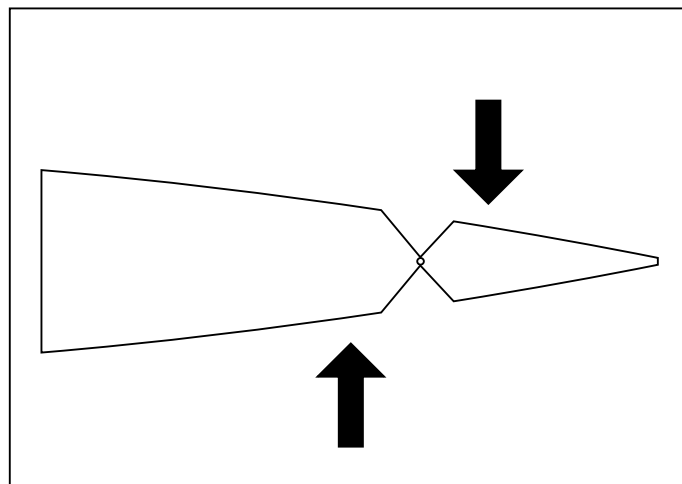

Figure 1 - Test for hinge movement and loose hinges

AMA SAFETY CODE

When flying your aircraft, we recommend following the guidelines set by the Academy of Model Aeronautics (AMA). You can find their safety handbooks as well as more information on the AMA at their website, located at the address below:

www.modelaircraft.org



FLYING YOUR QQ YAK 55 10E SUPER PNP

Selecting a Flying Site

Selecting a flying site is critical to a successful flight. Airplanes require a lot more room than other R/C products, therefore, a neighborhood or parking lot is less than ideal. A large open field with short grass and generous overfly area are the best candidates if no AMA field is available in your area. Know your overfly area - ensure that there are no houses, playgrounds, or other buildings that may be damaged if the airplane were to crash.



Takeoff

Taxi or place the aircraft on the runway centerline, with the nose pointed into the wind. Select Select Flight Mode 1 with the gyro kill switch set to gyro on, then set the throttle trim so that the motor spins at its lowest RPM without stopping. Smoothly advance the throttle to full while maintaining directional control with the rudder and slight back pressure on the elevator. The airplane should lift off smoothly before the throttle is fully open. Fly in Flight Mode 1 until the aircraft is fully trimmed (see special trimming instructions), and you are comfortable with its handling, then explore the other modes as desired.

Flying

Altitude is your friend on the first flight. Briskly climb to a safe altitude and trim the airplane out. The airplane should fly straight and level at 2/3 to 3/4 power with no hands on the transmitter. Try some basic maneuvers, and slowly progress into the airplane's flight envelope as you become more comfortable with the airplane's flight qualities and perfect your setup. Note: If at any time you experience unexpected control system inputs or oscillations, switch off the gyro function using your gyro kill switch (assigned on page 12), land and troubleshoot the issue.

Landing

Be mindful of your flight time and allow adequate battery reserve for a couple of go-arounds, if necessary, on the first few flights. Select Flight Mode 1 and slow the airplane and align with the runway, into the wind. The airplane should descend smoothly in this configuration with proper airspeed. Once you are close to the ground, gradually close the throttle fully and begin to smoothly apply up elevator as required to arrest descent and the airplane should gently touch down with a short roll out.



CAUTION

USE CAUTION WHEN FLYING YOUR QQ YAK 55 10E SUPER PNP IN MODE 3 AT HIGH AIRSPEEDS. DOING SO CAN INDUCE CONTROL SURFACE OSCILLATIONS AND MAY CAUSE A CRASH.

Trimming

The first several flights on your new QQ Yak 55 10E Super PNP should be dedicated to trimming and setup. Fly the airplane at 2/3 power in any Flight Mode you are comfortable flying in, and trim for level flight. **DO NOT CHANGE FLIGHT MODES. Land, adjust linkages or execute Quick Trim (see below) and return the trim and/or sub-trim to zero and fly again. Repeat process until the airplane flies hands off, straight and level.**

Transmitter trim or sub-trim will cause trim shifts when different flight modes are selected. To eliminate this trim shift, the model should be mechanically trimmed, or Aura "Quick Trim" may be used instead.

Aura Quick Trim

The Aura 8 features a Quick Trim Mode that eliminates the need for mechanical linkage adjustments during test flights. Aura will learn the trim values from your transmitter, and apply them to the control surfaces at power up when enabling quick trim mode.

NOTE: Quick Trim can also be used BEFORE flying to make small changes to center the control surfaces before flight.

1. Fly the airplane in your preferred Flight Mode at 2/3 power. Trim the aircraft with the transmitter trimmers and land. **DO NOT CHANGE FLIGHT MODES.**
2. Power off the QQ Yak 55 10E Super PNP. Insert a bind plug into Aura Port S3 (you will need to remove the servo lead that is currently in S3). Check the transmitter is on and re-power the Aura to enter Quick Trim.
3. Wait 5 seconds for the Aura to completely initialize. Confirm Quick Trim mode is active by checking the Blue LED is slowly flashing.
4. Remove the bind plug from Aura Port S3 to save your trim settings. Re-install the servo that was previously removed into port S3. Removing the bind plug stores the current trims in the Aura. The Blue LED will flash quickly after control surface trim values are stored. While the trim values are stored in Aura, they are not applied to the control surface(s) until the Aura is re-powered.
5. Remove power from the QQ Yak 55 10E Super PNP and center all control surface trims on the transmitter.
6. Re-power the QQ Yak 55 10E Super PNP. The control surfaces should be unchanged even though the trim has been centered on the transmitter.
7. Switch between other Flight Modes to ensure you do not see any changes in trim.

NOTE: QUICK TRIM MAY BE REPEATED AS NEEDED FOR FINE TUNING, OR IF CHANGES TO THE AIRCRAFT ARE MADE.

NOTE: ENSURE AILERON/ELEVATOR/RUDDER SUB-TRIMS ARE AT ZERO IN THE TRANSMITTER **BEFORE** FLYING FOR THE QUICK TRIM PROCESS TO WORK PROPERLY.

AIRFRAME REPAIRS

The QQ Yak 55 10E Super PNP is molded from durable EPO foam and is repairable with most adhesives. Similar to building and repairing wood or composite airplanes, the correct glue for a given application is critical to the repair holding and not breaking again. For major repairs, such as a broken fuselage, epoxy is preferred because it allows time to correct any misalignment. For smaller repairs, such as a cracked control surface or small chunk of material missing from the airframe, regular CA is very effective. The use of odorless (foam safe) CA is not required and not recommended on EPO foam aircraft because it takes a longer period of time to cure than regular CA and the bond tends to be weaker.

NOTE: Avoid the use of CA accelerant in repairs. It can damage paint and will weaken the bond of the glue. If CA accelerant is used, be mindful of the locations of CA to prevent premature bonding of parts, or bonding a hand or clamp to the airframe.

If a part is damaged too badly to be repaired, please refer to the table on page 3 for a complete listing of spare airframe parts.

NOTICE

If a crash is imminent, fully reduce the throttle to prevent further damage to the power system and reduce energy to lessen impact damage. Never allow the propeller to contact the ground under power, even idle.

CRASH DAMAGE IS NOT COVERED UNDER ANY PRODUCT WARRANTY.

NOTE: Avoid keeping the airplane in direct sunlight when not flying. Excessive heat can damage the airplane's structure and UV damage can permanently discolor decals.

REPLACING SERVOS

Required Tools and Fasteners: #1 Phillips Screwdriver

1. Disconnect the servo from the Aura 8.
2. Unscrew the servo arm from the servo and remove the servo arm.
3. Unscrew the two servo mounting screws at each end of the servo and remove. Note that some servos may be connected to a servo extension. This extension should be left in the wing or fuselage when the servo is replaced.

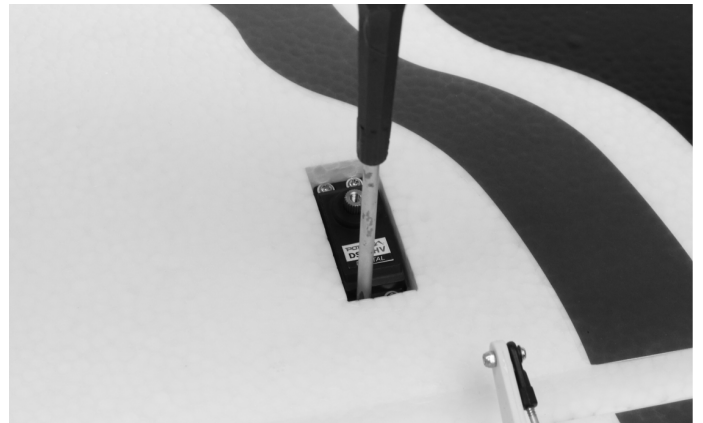
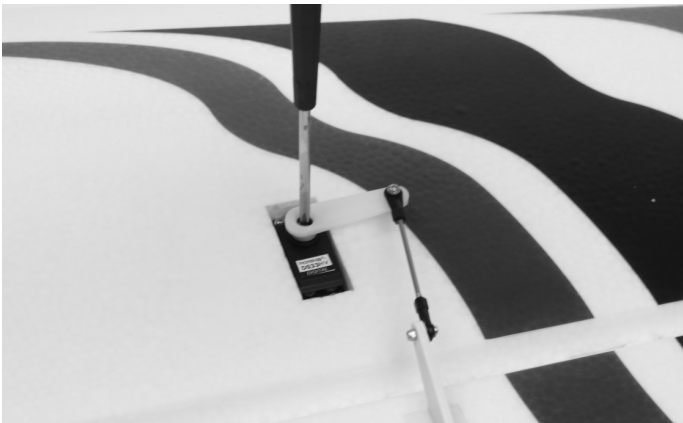

AIRCRAFT TROUBLESHOOTING GUIDE

Should you encounter any abnormal situations with your QQ Yak 55 10E Super PNP, refer to the table below to determine the probable cause and a recommended solution for the issue.

If the required solution does not rectify the problem, please contact product support at support@flexinnovations.com for further assistance.



NOTICE

Unless specifically required, ALWAYS troubleshoot the airplane with the propeller removed.

DISCREPANCY	PROBABLE CAUSE	RECOMMENDED SOLUTION
Motor non-responsive (no ESC initialization tones audible)	Throttle not at idle and/or throttle trim too high	Lower throttle stick and trim completely. If problem persists, ensure that the sub-trim and travel adjust are properly set in the radio's programming
	Motor disconnected from ESC	Ensure plugs are fully seated. Check battery and/or plugs for damage and replace any damaged components found - DO NOT ATTEMPT REPAIR
Motor non-responsive (throttle calibration tones received)	Throttle channel is reversed	Reverse throttle channel in radio programming
Motor turns in the wrong direction	The three motor wires are connected incorrectly to the ESC	Swap any TWO motor wires
Reduced flight time or aircraft underpowered	Battery not fully charged	Ensure battery is fully charged prior to installing in aircraft
	Propeller installed backwards	Install propeller so that the convex side faces forward (tractor configuration)
	Battery is too weak or damaged	Remove battery from service completely and replace with a different battery
	Ambient temperature is too cold	Ensure battery packs are adequately warm (70°F/21°C) before flight
	Battery capacity too small for intended use	Replace battery with one of proper capacity and discharge capacity
	ESC reaching preset LVC (low-voltage cutoff)	Recharge flight battery or reduce flight time
Excessive propeller noise and/or vibration	Battery's discharge rating may be too small	Replace battery with one with higher 'C' rating
	Damaged spinner and/or propeller, collet, or motor	Replace damaged components - DO NOT ATTEMPT REPAIR
	Propeller is not balanced	Balance or replace the propeller
	Prop nut is loose	Tighten prop nut with appropriate-sized wrench
	Spinner is not fully in place or tightened	Loosen the spinner bolt, adjust as required, retighten spinner bolt
Control surfaces nonresponsive	Propeller nut or propeller adapter threads not cut straight	Replace propeller nut or propeller shaft - DO NOT ATTEMPT REPAIR
	Airframe or control linkage system damage	Examine airframe for damage, repair as required; inspect control linkage system (servo, pushrod, control horn) for damaged components and replace as required
	Wire damaged or connector loose	Examine wires and connections, replace as necessary
	Transmitter bound incorrectly, incorrect active model memory, incorrect Aura data input configuration, incorrect Aura transmitter settings	Consult radio manual for proper binding and model selection instructions
	Battery voltage too low	Use volt meter to check battery; recharge or replace as necessary
	Battery disconnected from ESC	Check that the EC3 plugs are fully seated
	BEC (battery elimination circuit) damaged	Replace ESC - DO NOT ATTEMPT REPAIR
Damaged Servo	Replace Servo - DO NOT ATTEMPT REPAIR	
Failed control direction test	Incorrect Aura 8 or Transmitter Setting - DO NOT FLY!	Reference transmitter and receiver sections of this manual. Refer to control surface direction chart and transmitter setup; adjust appropriate settings as required. Check QQ Yak 55 10E Super PNP and Aura wiki web pages for additional information. If no solution is found, contact customer support at support@flexinnovations.com
Failed Sensor Direction Test	Aura 8 is not mounted in the proper orientation	Mount Aura in the proper orientation
	Aura 8 settings incorrect	Reference the transmitter and receiver sections of this manual. If no is solution is found, contact customer support at support@flexinnovations.com
Control surface oscillation	Exceeding maximum airspeed for configuration	Reduce airspeed
	Gains too high for aircraft/flight configuration	Refer to Aura 8 manual to decrease desired control surface gain
	Propeller/spinner not balanced	Balance or replace propeller and/or spinner
	Motor vibration	Inspect motor mounting bolts and re-tighten as necessary
	Loose Aura 8 mounting	Re-align and secure the Aura 8 to the aircraft
	Control linkage slop	Examine control system and repair or replace worn components
	Improper transmitter setup	Refer to Aura 8 manual to correctly configure transmitter
	Damaged propeller or spinner	Replace damaged component- DO NOT ATTEMPT REPAIR
Improperly set master gain	Ensure master gain is set for proper gain value	
Trim changes between flight modes	Trims are not properly zeroed	Readjust control linkage and re-center trims in radio
	Sub-trim is not properly zeroed	Remove sub-trim; adjust the servo arm or clevis to achieve proper geometry
	Transmitter is not properly calibrated (aileron/elevator/rudder are not neutral with sticks centered; reference transmitter monitor)	Calibrate transmitter (reference manufacturer's instructions, or return to manufacturer for calibration)
Gyro doesn't respond to aircraft movements	Gyro kill switch not setup on transmitter	Follow the transmitter configuration guide, assign CH6/Gear to a two-position switch
	Gyro kill switch in off position	Move the gyro kill switch to the on position

LIMITED WARRANTY

Warranty Coverage

Flex Innovations LLC and its authorized resellers ("Flex") warrant to the original purchaser that this product (the "Product") will be free from defects in materials and workmanship at the date of purchase.

Outside of Coverage

The warranty is not transferable and does not cover:

- (a) Products with more than 45 days after the purchase date
- (b) Damage due to acts of God, accident, misuse, abuse, negligence, commercial use, or due to improper use, installation, operation, or maintenance
- (c) Damage to other components or assemblies associated with the use of the Product.
- (d) Modification of or to any part of the Product
- (e) Product not purchased from an authorized Flex Innovations dealer or distributor.
- (f) Product that has been partially, or fully assembled
- (g) Shipping damage
- (h) Cosmetic damage
- (i) Services or labor associated with the repair, use or assembly of the Product.

OTHER THAN THE EXPRESS WARRANTY ABOVE, FLEX MAKES NO OTHER WARRANTY REPRESENTATION, AND HEREBY DISCLAIMS ALL IMPLIED WARRANTIES, INCLUDING, WITHOUT LIMITATION, THE IMPLIED WARRANTIES OF NONINFRINGEMENT, MERCHANTABILITY AND FITNESS FOR A PARTICULAR PURPOSE. THE PURCHASER ACKNOWLEDGES THAT THEY ALONE HAVE DETERMINED THAT THE PRODUCT WILL SUITABLY MEET THE REQUIREMENTS OF THE PURCHASER'S INTENDED USE.

Purchaser's Remedy

Flex's sole obligation and purchaser's sole and exclusive remedy shall be that Flex will, at its option, either (i) service, (ii) replace any part of the Product determined by Flex to be defective, or (iii) replace the Product determined by Flex to be defective. Flex reserves the right to inspect all Product(s) involved in a warranty claim. Service or replacement decisions are at the sole discretion of Flex. Proof of purchase is required for all warranty claims. **SERVICE OR REPLACEMENT AS PROVIDED UNDER THIS WARRANTY IS THE PURCHASER'S SOLE AND EXCLUSIVE REMEDY.**

Limitation of Liability

FLEX SHALL NOT BE LIABLE FOR SPECIAL, INDIRECT, INCIDENTAL OR CONSEQUENTIAL DAMAGES, LOSS OF WAY, REGARDLESS OF WHETHER SUCH CLAIM IS BASED IN CONTRACT, WARRANTY, TORT, NEGLIGENCE, STRICT LIABILITY OR ANY OTHER THEORY OF LIABILITY, EVEN IF FLEX HAS BEEN ADVISED OF THE POSSIBILITY OF SUCH DAMAGES.

Further, in no event shall the liability of Flex exceed the individual price of the Product on which liability is asserted. As Flex has no control over use, setup, assembly, modification or misuse, no liability shall be assumed nor accepted for any resulting damage and/or injury. By the act of use, setup or assembly, the user accepts all resulting liability. If you as the purchaser or user are not prepared to accept the liability associated with the use of the Product, purchaser is advised to return the Product immediately in new and unused condition to the place of purchase.

Law

These terms are governed by Florida law (without regard to conflict of law of principals). This warranty gives you specific legal rights, and you may also have other rights which vary from state to state. FLEX RESERVES THE RIGHT TO MODIFY THIS WARRANTY AT ANY TIME WITHOUT NOTICE.

Questions & Assistance

Contact Us By:

E-Mail – support@flexinnovations.com

Phone – 1 (866) 310-3539

Inspection or Services

If this Product needs to be inspected or serviced and is compliant in the region you live and use the Product in, please contact your regional Flex authorized reseller. Pack the Product securely using the original shipping carton. Please note that both the inner and outer boxes need to be included. The inner box is not designed to withstand the rigors of shipping without additional protection from the outer shipping carton. Ship via a carrier that provides tracking and insurance for lost or damaged parcels, as Flex is not responsible for merchandise until it arrives and is accepted at our facility.

Warranty Requirements

For Warranty consideration, you must include your original sales receipt verifying the proof of purchase date. Provided any warranty conditions have been met, your Product or its defective parts will be replaced or serviced free of charge. Responsibility of shipping charges are as follows:

To Flex from customer, Customer is responsible.

To Customer from Flex, Flex is responsible.

Service or replacement decisions are at the sole discretion of Flex.

COMPLIANCE INFORMATION FOR THE EUROPEAN UNION

 Declaration of Conformity (In accordance with ISO/IEC 17050-1)

Product(s): QQ Yak 55 10E Super PNP
Item Number(s): FPM4670A
FPM4670B
FPM4680A
FPM4680B

The object of declaration described above is in conformity with the requirements of the specifications listed below, following the provisions of the EMC Directive 2004/108/EC.

EN 55022: 2010+AC: 2011

EN 55024: 2010

EN 61000-3-2: 2006+A2:2009

EN 61000-3-3: 2013

EN 61000-6-3: 2007/A1:2011

EN 61000-6-1: 2007



Instructions for disposal of WEEE by users in the European Union

This product must not be disposed of with other waste. Instead, it is the user's responsibility to dispose of their waste equipment by handing it over to a designated collections point for the recycling of waste and electronic equipment. The separate collection and recycling of your waste equipment at the time of disposal will help to conserve natural resources and ensure that it is recycled in a manner that protects human health and the environment. For more information about where to drop off your waste equipment for recycling, please contact your local city office, your household waste disposal service or where you purchased the product.

Building and Flying Notes

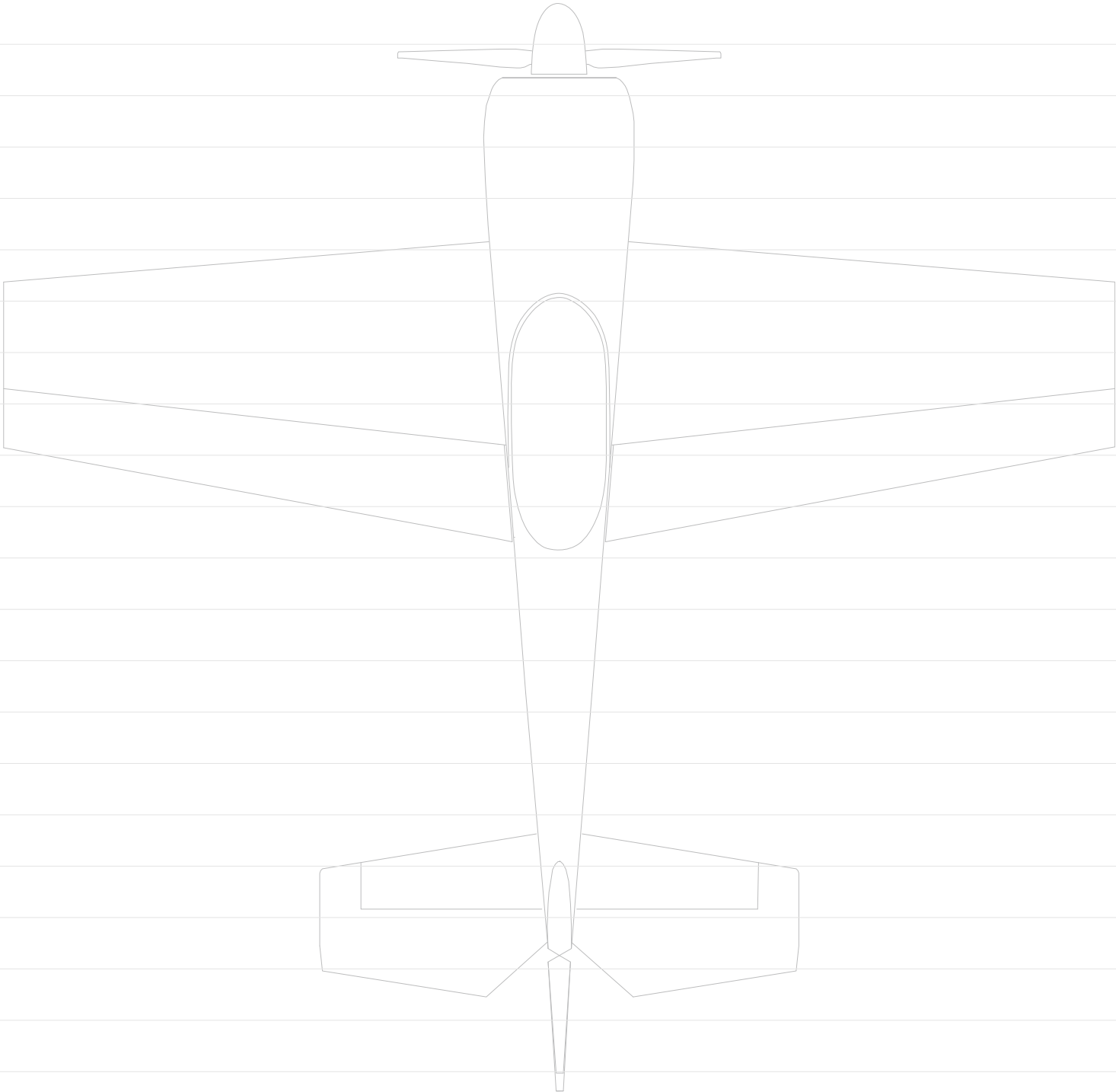

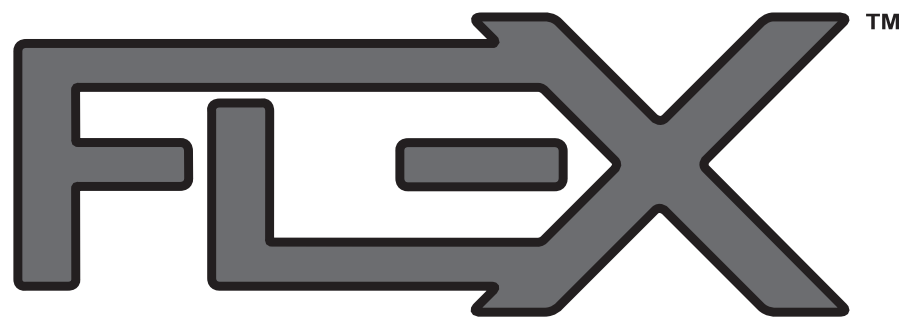

INNOVATIONS

www.flexinnovations.com

© 2022 Flex Innovations, LLC. All rights reserved.

Potenza™ is a trademarks of Flex Innovations LLC

DSM®, DSM2™, and DSMX™ are trademarks of Horizon Hobby, Inc.

Futaba is a registered trademark of Futaba Denshi Kogyo Kabushiki Kaisha Corporation of Japan.

Jeti, UDI, and Jeti Model are trademarks or registered trademarks of Jelen, Ing. Stanislav of Czech Republic

HoTT is a registered trademark of SJ, Inc.