

# MAFERA

## 120



*Giuseppe Tompazini*

**FLEX**  
INNOVATIONS™





**BEFORE CONTINUING WITH THIS INSTRUCTION MANUAL OR THE ASSEMBLY OF YOUR AIRCRAFT, PLEASE VISIT OUR WIKI SUPPORT SITE FOR THE LATEST PRODUCT UPDATES, FEATURE CHANGES AND MANUAL ADDENDUMS FOR THIS PRODUCT.**

[wiki.flexinnovations.com/wiki/mamba120](http://wiki.flexinnovations.com/wiki/mamba120)



The Mamba 120 combines light weight and modern design with the latest 3D/aerobatic biplane knowledge from Quique Somenzini. Experience and intense attention to every aerodynamic and geometric detail allow a biplane experience not available anywhere else! Starting with a Model 12, officially licensed from Jim Kimball Enterprises, Quique Somenzini has made extensive changes to further refine the design and further perfect it as a 3D aerobatic model.

Light wing loading and absolute minimum control coupling are key to great 3D performance and the Mamba 120 excels in this area. Years of F3A and 3D biplane experience make Quique uniquely qualified to design and further refine the Mamba to fly just right.

**Specifications:**

Wingspan:	85 in. (2160mm)
Length:	97 in. (2462mm)
Weight with recommended equipment (no fuel):	29 lbs. (13.15kg)

## Required Equipment:

Transmitter:	8+ channels
Receiver:	8+ channels, high-voltage capable
Servos:	Minimum 450 oz/in (32kg/cm) for all control surfaces with a high-quality throttle servo. The recommended servo for all control surfaces (7) is the Potenza 49010BLHV brushless, high voltage servo. The recommended servo for the throttle is the Potenza DS22209HV high voltage servo.
Servo Arms:	<b>Aileron (4)</b> – 2 inch single (Potenza 2-inch Clamping Servo Arm – FPZA1036 recommended) <b>Elevator (2)</b> – 2-inch single (Potenza 2-inch Clamping Servo Arm – FPZA1036 recommended) <b>Rudder (1)</b> – 4 -inch double sided (Potenza 4-inch Clamping Servo Arm – FPZA1037 recommended)
Receiver Battery:	(2) 2S LiPo 2000 15C+ (FPZBR20002S15 recommended)
Ignition Battery:	(1) 2S LiPo 2000 15C + (FPZBR20002S15 recommended)
Engine:	100cc to 125cc gasoline (petrol) two-stroke, twin cylinder engine (Desert Aircraft DA-120 - FPMDA120 recommended)
Exhaust:	Follow your engine manufacturer's recommendation, as well as local noise restrictions in your area. (DA stock muffler set by Slimline – FPMDA120MUFFLER recommended)
Engine Standoffs:	(4) ¾-inch (20mm) Aluminum Standoffs (FPM1624 recommended)
Propeller:	Follow your engine manufacturer's recommendation. With the Desert Aircraft 120cc engine, the Flex 27x10.8 or Falcon 28x9.5
Spinner:	5-1/2 inch (140mm), P-51 shape (Falcon 5.5in carbon fiber spinner – FPMF55CF recommended)
Servo Extensions:	(3) 36-inch (900mm) servo extensions (2 from receiver through the top wing center section and (1) for throttle) (2) 18-inch (350mm) servo extensions (2 from receiver to bottom wing) (2) 9-inch (200mm) servo extensions (2 for bottom wing panels) (2) 48-inch (1250mm) servo extensions (2 from receiver to elevator servos)

Flex Innovations has a servo extension kit available. This kit includes all the necessary servo extensions for the Mamba 120. The part number for this kit is FPZA1033.

**Optional Equipment:**

- Aura 8 Professional (FPZAURA08PRO)
- 32 oz. (1 liter) Smoke Tank (FPM1623)
- Flex Innovations Premium Wing and Tail Bag Set (FPM1614)
- Flex Innovations Stretch Fabric Sunshade (Flex FPM1628)
- ISDT D2 Dual Port AC 200W Charger (ISDTD2)
- (2) KS 3086 canisters for the DA-120
- MTW 70mm drop, flexible header set for the DA-120

**Hangar 9®/Ultracote®/Oracover® Colors**

**Yellow/Black Scheme:**

Ultracote®	Oracover®
Dark Yellow (HANU889)	Golden yellow 21-032
Silver (HANU881)	Silver 21-091
Black (HANU874)	Black 21-071
White (HANU870)	White 21-010

**Blue/Red scheme:**

Ultracote®	Oracover®
True Red (HANU866)	Ferrari Red 21-023
Deep Red (HANU871)	Red 21-020
Midnight Blue (HANU885)	Dark Blue 21-052
Silver (HANU881)	Silver 21-091
White (HANU870)	White 21-010

## **USING THIS MANUAL**

This manual is divided into sections to make the assembly of the airplane easier to follow. Note the circles “○” next to each step that can be checked off to help you keep track of the steps that have been completed.

## **ATTENTION**

Read the ENTIRE instruction manual to become familiar with the features and assembly of the product before operating. Failure to assemble or operate the product correctly can result in damage to the product, personal property and cause serious or fatal injury.

All instructions, warranties and other collateral documents are subject to change at the sole discretion of Flex Innovations, LLC. For up-to-date product literature, please visit our website at [www.flexinnovations.com](http://www.flexinnovations.com) and navigate to the product page for this product.

## **WARNING**

This is NOT a toy. This product is not intended for use by children under 14 years of age without direct adult supervision.

## **IMPORTANT INFORMATION REGARDING WARRANTY**

Please read our Warranty and Liability section before building this product. If you as the Purchaser or User are not prepared to accept the liability associated with the use of this product, you are advised to return this product immediately in new and unused condition, in the original packaging material, to the place of purchase.

## **SAFETY WARNINGS AND PRECAUTIONS**

Protect yourself and others by following these basic safety guidelines.

1. This manual contains instructions for safety, operation and maintenance. It is essential to read and follow all the instructions in the manual, prior to assembly, setup or use, in order to operate correctly and avoid damage or serious injury.
2. In some cases, the written instructions may differ slightly from the photos. In those instances, the written instructions should be considered correct.
3. This model is not a toy, rather it is a sophisticated hobby product and must be operated with caution and common sense. This product requires some basic mechanical ability. Failure to operate this product in a safe and responsible manner could result in injury, or damage to the product, or other property.
4. This model must be assembled according to these instructions. Do not alter or modify the model outside of these instructions provided by Flex Innovations, LLC, as doing so may render it unsafe and/or unflyable. You must take time to build straight, true and strong. It is your responsibility to ensure the air worthiness of this product.
5. Use only compatible, appropriate components for the final assembly of this model. Ensure that the radio system is in functional condition, that the engine is appropriately sized for the model and that all other components are appropriate for use in this model as specified in this instruction manual. All components must be installed correctly such that they operate correctly both on the ground and in the air.
6. Inspect and check operation of the model and all its components before every flight.
7. If you are not an experienced pilot, or have not flown a high-performance model before, it is recommended that you seek assistance from an experienced pilot in your R/C club for your first flights. If you're not a member of a club, the Academy of Model Aeronautics (AMA) has information about clubs in your area whose membership includes experienced pilots.
8. Keep the propeller area clear from such items as loose clothing, jewelry, long hair, or tools, as they can become entangled. Keep your hands and body parts away from the propeller as injury can occur.

## SPECIAL LANGUAGE DEFINITIONS

The following terms are used throughout the product literature to indicate various levels of potential harm when operating the product.

- NOTICE: Procedures, which if not properly followed, create a possibility of physical property damage AND a liable or no possibility of injury.
- CAUTION: Procedures, which if not properly followed, create a probability of physical property damage AND a possibility of serious injury.
- WARNING: Procedures, which if not properly followed, create the probability of property damage, collateral damage and serious injury OR create a high probability of serious injury.

## IMPORTANT BEFORE ASSEMBLY

Carefully unpack your aircraft and inspect the parts. Review the manual and gather the required tools and supplies.

- Remove all parts from their plastic bags, inventory all items and closely examine all the major airframe components for damage. If any items are missing or you find damaged components, do not proceed. Please contact customer support.
- Use a covering iron with a covering sock on high heat to tighten the covering as necessary, paying special attention to the leading edges of the flying surfaces, hinge lines and stabilizer and wing saddle areas. Apply slight pressure over sheeted areas to thoroughly bond the covering to the wood. Use caution around seams to prevent inadvertently pulling them loose.
  - **Pro-Tip:** You can use a “Seal-It Pen” to permanently seal any sharp edges or corners of covering that may come loose in flight.
- Use thin CA to go over any important glue joints, such as the motor box, firewall, servo mounting rails and any other pre-assembled joints that may see high stress during flight.
- Gather all required components such as motor and radio equipment that will be used to equip the airplane. Create a new radio program in your transmitter and bind this model program to the receiver that will be used in the airplane

## INTERPLANE STRUT BLOCK INSTALLATION

### Required Components

- Main Wing Panels (4)
- Interplane Strut Blocks (4)

### Required Adhesives

- 30-Minute Epoxy

### Required Tools/Building Materials

- Covering Iron/Trim Iron
- Low-Tack Tape
- Hobby Knife with #11 Blade
- Isopropyl Alcohol
- Paper Towels

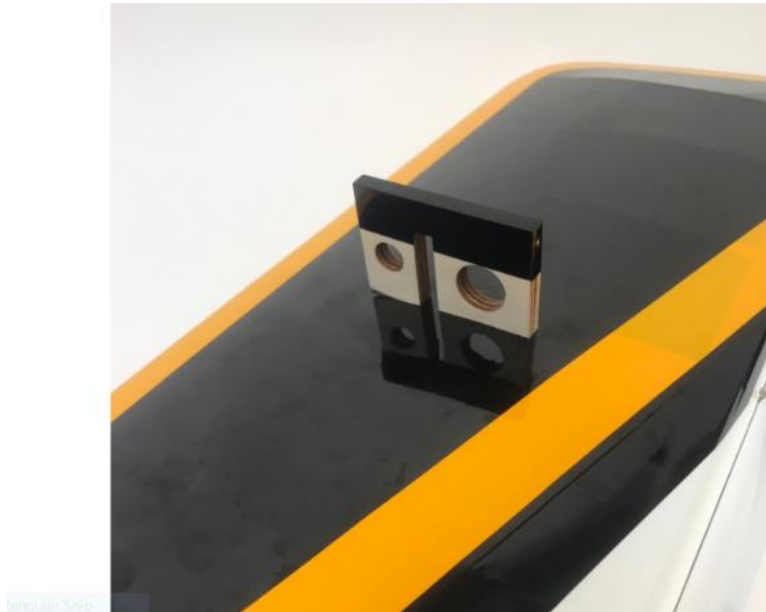

- 1. Locate the slots in the wing for the interplane strut block. These slots are in the top of the bottom wings and the bottom of the top wings. Use a hobby knife with #11 blade to carefully cut and remove the covering from this slot, while leaving approximately 1/8-inch (3mm) extra covering over the inside of the slot. Cut the corners at a 45-degree angle and use a covering or trim iron to seal the covering down into the slot.



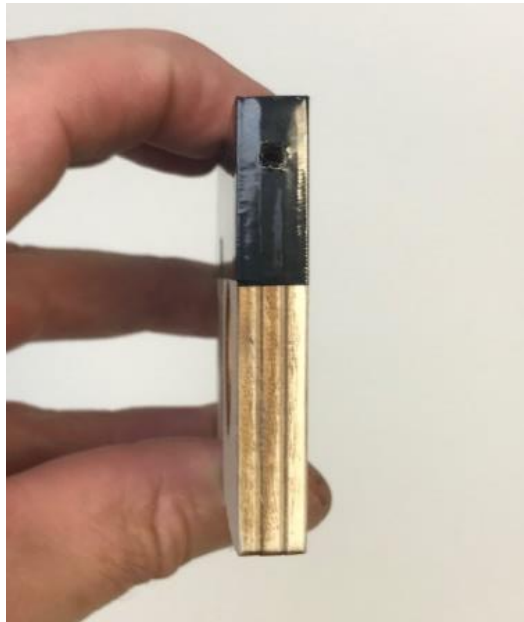

- 2. Locate the interplane strut blocks. They should be labeled according to their specified location, top or bottom. Use a hobby knife with a #11 blade to carefully cut and remove the covering from the holes for the interplane strut retention pin.

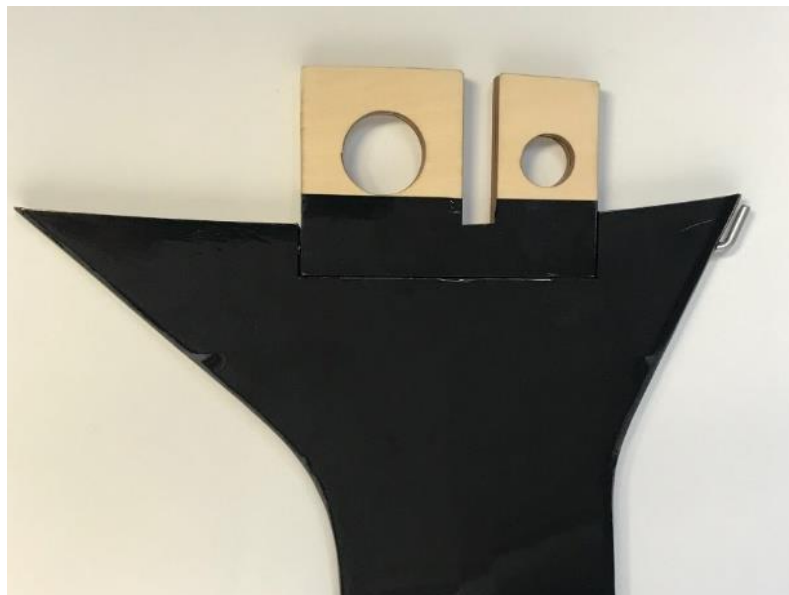

- 3. Locate the interplane struts. The interplane struts should be labeled according to left and right struts, as well as top and bottom. Place the corresponding block in position and use the 4mm retention pin to secure it in place. Note that the pin may be tight on when first used but it will loosen with time.

#### **Quique's Tip**

While you are test fitting these parts, verify that pin fits tight and is not loose. The pin should fit tight and may require the use of pliers to install. If the pin fit is loose, apply a small amount of thin CA to the retention pin hole in the strut. **DO NOT USE ACCELERATOR** on the CA; let it cure at its own pace. As you fly the model, repeat this as many times as needed if the retention pins loosen over time.



- 4. Test fit the strut and strut block into the wing to confirm proper fit.

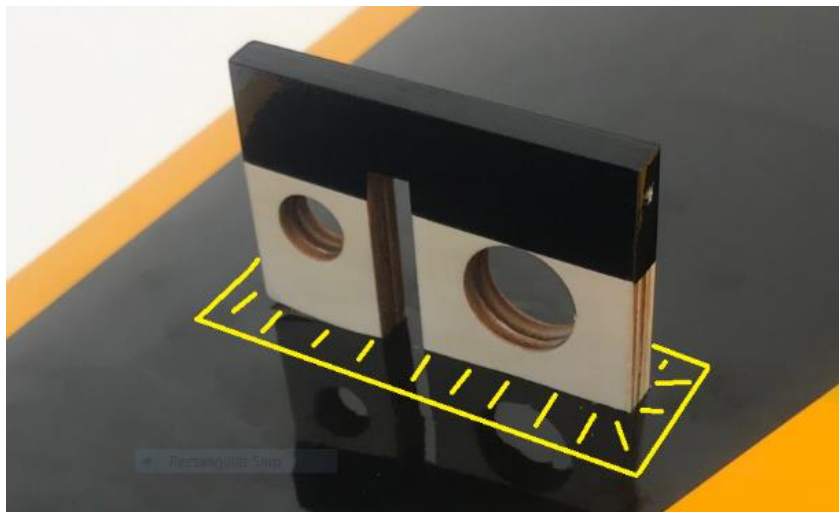

- 5. Once the fit is confirmed, apply low-tack tape around the slot in the wing. Mix an adequate amount of 30-minute epoxy and apply it to the slot. Insert the strut block (with the strut still attached) into the wing. Clean up any excess epoxy with isopropyl alcohol and a paper towel as needed and let the epoxy cure. Repeat this procedure for all 4 strut mounting blocks.

## **AILERON SERVO AND LINKAGE INSTALLATION**

### **Required Components**

- Main Wing Panels (4)
- Aileron Linkage (4)
- M3 Lock Nut (8)
- Aileron Servos (4)
- Aileron Servo Arms (4)
- Ball Links (8)
- M3 Washer (16)
- 9-inch (200mm) Servo Extension (2)
- M3 x 15 Socket Head Cap Screw

### **Required Adhesives**

- Thin CA
- Blue Thread Lock

### **Required Tools/Building Materials**

- #1 Phillips Screwdriver
- Thread or Shrink Tubing
- 2.5mm Hex Driver
- 5.5mm Nut Driver

- 1. Use a #1 Phillips screwdriver to thread a servo mounting screw into each of the pre-cut holes in the servo mounting rails in the wing. Remove the screw and apply a small amount of thin CA to each of the holes to harden the threads cut by the screw. Do not use CA accelerator. Let the CA fully cure before moving forward.
- 2. Secure a 9-inch (200mm) servo extension to two of the aileron servos. These will be used for the lower wings. Use heat shrink tubing or thread to secure the connection.
- 3. Insert the aileron servo into the servo bay with the output shaft towards the leading edge of the wing. Be sure to route the servo lead out of the wing before mounting the servo. Mount the servo to the wing using the servo mounting screws provided with your servos. Be sure to install the two servos with the extension in the bottom wings.
- 4. Use your radio system to center your aileron servos. Install your aileron servo arm onto the servo as close to parallel with the hinge line as possible. Apply blue thread lock to the servo arm screw and fully tighten the screw. If your servo arms have output shaft clamping screws, apply blue thread lock and secure them in place at this time.
- 5. Using a pushrod with a length of 2-3/4 inches (70mm), assemble the aileron linkages so that the total length from center of ball to center of ball is approximately 98mm for the top wings and 95mm for the bottom wings. Final length will be adjusted when centering the control surface. Note that the opposite ends of each aileron linkage have opposite direction threads.
- 6. Attach the linkage to the servo arm. The correct hole location is 1-3/4-inches (44mm) from center. If using the recommended 2-inch servo arm, this is the second to outermost hole. The order of hardware for this connection, starting away from the wing is as follows:
  - M3x15 Socket Head Cap Screw
  - M3 Washer
  - Ball Link
  - M3 Washer
  - Servo Arm
  - M3 Lock Nut

- 7. With the radio powered on and the servo centered with the arm parallel to the hinge line, adjust the linkage length so that the control surface is centered. When satisfied with the length of the linkage, secure the linkage to the control horn with the hardware in the following order:
  - M3x15 Socket Head Cap Screw
  - M3 Washer
  - Control Horn (Side 1)
  - Ball Link
  - Control Horn (Side 2)
  - M3 Washer
  - M3 Lock Nut

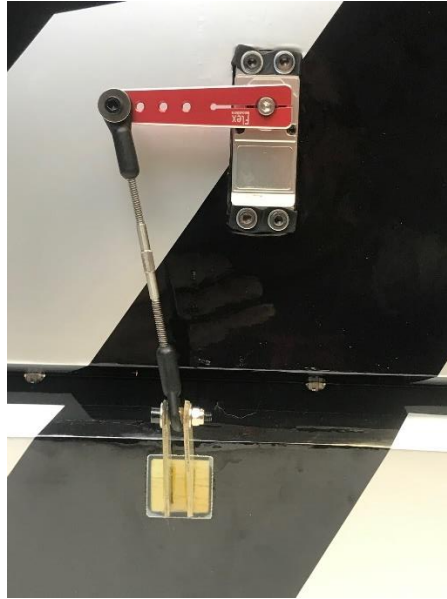

After the steps above are completed and the servo and linkages are installed, the assembly should appear as the picture above; all four ailerons should be the same.

Note: Picture above shows a 1-3/4-inch (44mm) servo arm, not the recommended 2-inch servo arm).

Note: The angle of the linkage is correct. As the servo arm rotates and the control surface deflects, the linkage will straighten.

## TAILWHEEL INSTALLATION

### Required Components

- Fuselage
- Tail Gear Assembly
- Steering Ball Link (1)
- M3x12 Socket Head Cap Screw (3)
- M3 Flat Washer (3)
- 00mm) Servo Extension
- M3 x 15 Socket Head Cap Screw

### Required Adhesives

- Blue Thread Lock

### Required Tools/Building Materials

- Hobby Knife with a #11 blade
- Drill
- 1/8-inch (4mm) drill bit
- 2.5mm Hex Driver
- 5.5mm Nut Driver

- 1. Locate the three tailwheel mounting holes in the bottom of the fuselage near the rudder hinge line. Use a hobby knife with a #11 blade to open the 3 mounting holes.
- 2. Verify that the tailwheel assembly hardware is tight and secure.
- 3. Place a washer over an M3x15 socket head cap screw, apply blue thread lock to the threads and pass the screw through the tailwheel bracket. Secure the screw in place with a 2.5mm hex driver. Repeat for the other two screws.



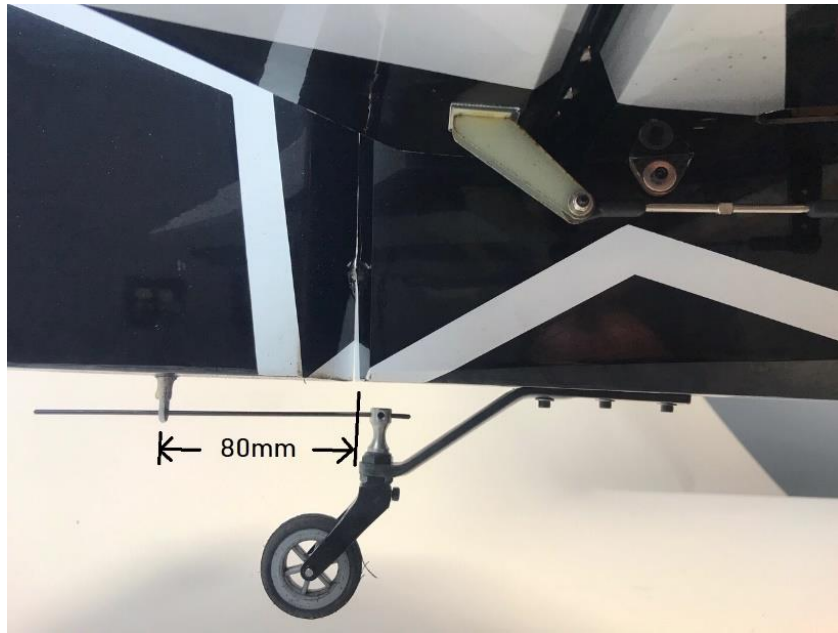

- 4. Use a drill and a 1/8-inch (4mm) drill bit to drill a hole in the bottom center of the rudder. Place this hole approximately 3-1/4-inches (80mm) from the hinge line.
- 5. Test fit the ball linkage into this hole. Once satisfied with the fit, mix a small amount of 30-minute epoxy and glue the steering ball link in place. Be sure to orient so that the steering pushrod can go through the ball link as shown in the photo above.

## RUDDER AND RUDDER CONTROL HORN INSTALLATION

### Required Components

- Rudder Control Horns (4)
- Rudder Control Horn Base Plates (2)
- Rudder hinges (5)

### Required Adhesives

- Isopropyl Alcohol
- 30-minute Epoxy

### Required Tools/Building Materials

- Hobby Knife with a #11 blade

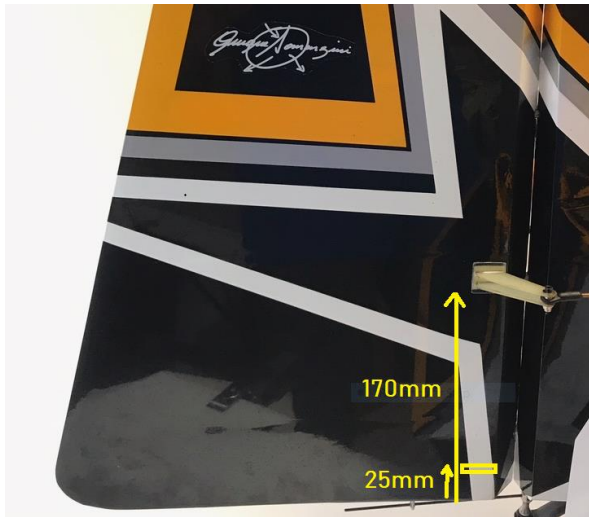

- 1. Locate the rudder. There are two control horn locations for the rudder depending on your setup. If using the pull-pull rudder setup (recommended for the recommended components), remove the covering from BOTH sides of the upper control horn slots. If using a push-pull rudder setup, remove covering ONLY from ONE SIDE of the lower control horn slot.

**IMPORTANT:** The pull-pull rudder setup is the recommended setup to achieve the proper CG with the recommended components. If you decide to use the push-pull rudder setup, you may need to use a heavier engine or move components significantly further forward to achieve the proper CG.

### Quique's Tip:

If you have any concern about CG, you can skip the rudder control horn and rudder servo installation until all other steps are completed. Then, check the CG with the rudder servo placed on top of one of the horizontal stabilizers. If the CG can not be achieved here, check the CG with the servo in its mounting location under the canopy to confirm its final placement.



- 2. If using the pull-pull rudder setup, you will need a total of four control horns and two base plates. If using push-pull, you will need only two horns and one base plate. The elevator and rudder control horns are identical.

Prepare the control horns by scuffing the portion of the control horn that is inserted into the control surface with medium grit sandpaper. Use isopropyl alcohol and a paper towel to remove any excess debris from the control horn.

- 3. Mix an adequate amount of 30-minute epoxy. Apply epoxy to the slot in the rudder as well as the control horns.

#### **Quique's Tips:**

- To ensure proper alignment of each control horn, you can secure the ball link to the horns and then glue the horn in place with the ball link attached. This will ensure even alignment of both control horns.
- You can reference the aileron control horns that are installed by the factory.
- 4. Use a hobby knife with a #11 blade to clean up the hinge holes in the rudder and the fuselage. Test fit the hinges. Check for minimal hinge gap and overall rudder alignment.
- 5. Use medium grit sandpaper to scuff the portion of each hinge that is inserted into the fuselage or rudder. Use isopropyl alcohol and a paper towel to clean any debris that may be left on the hinge after scuffing.
- 6. Use a toothpick or cotton swab to apply a small amount of petroleum jelly to the pivot point of each hinge. Do not apply petroleum jelly to the entire hinge. The petroleum jelly is used to prevent glue from adhering to the pivot of the hinge, keeping the hinge moving free.
- 7. Mix an adequate amount of 30-minute epoxy and apply epoxy to the hinge slots in the rudder. Insert a hinge into each slot in the rudder. Check for proper alignment. Use isopropyl alcohol and a paper towel to clean up any excess epoxy before it cures.





- 8. Repeat this process for gluing the hinges to the fuselage. Be sure to insert the tailwheel steering linkage through the ball link in the rudder. If you prefer, you can remove the tail gear and reinstall it later.

## RUDDER AND LINKAGE INSTALLATION

### Required Components

#### Both Setups

- Fuselage Assembly
- Rudder Servo

#### Pull-Pull Setup (Recommended by Quique)

- 4-inch Double Servo Arm
- Wire Crimps (4)
- Pull-Pull Cable (2)
- Ball Link (4)
- M3x15 Socket Head Cap Screw (4)
- M3 Flat Washer (8)
- M3 Lock Nut (4)

#### Push-Pull Setup

- 2-inch Single-Sided Servo Arm
- Ball Link (2)
- M3x15 Socket Head Cap Screw (2)
- M3 Flat Washer (4)
- M3 Lock Nut (2)
- 48-inch (1250mm) Servo Extension
- 4-5/16-inch (110mm) Linkage

#### Pull-Pull System

- 1. Use a #1 Phillips screwdriver to thread a servo mounting screw into each of the pre-cut holes in the servo mounting location on the rudder servo tray inside the fuselage. Remove the screw and apply a small amount of thin CA to each of the holes to harden the threads cut by the screw. Let the CA fully cure before moving forward.
- 2. Insert the rudder servo into the rudder tray inside the fuselage with the output shaft towards the nose of the airplane. Mount the servo to the tray using the screws provided with your servo.
- 3. Center the servo using your radio system. Install the 4-inch servo arm so that is perpendicular to the servo case. Apply a small drop of blue thread lock onto the servo arm screw and secure it in place. If you are using a servo arm with clamping screws, apply a drop of blue thread lock and secure them in place.

#### Quique's Tip:

You may find that the servo arm for pull-pull does not fit close to perpendicular to the servo case. Since the Mamba 120 does not require a servo arm with an offset for pull-pull, try rotating the arm 180° to see if it fits closer to perpendicular when mounted in this orientation.

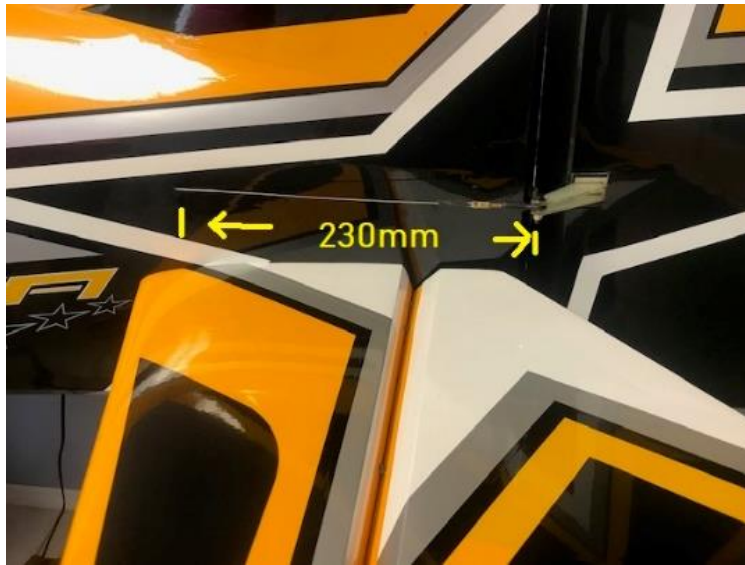

- 4. Locate the pull-pull cable exit holes in the rear of the fuselage. Use a hobby knife with a number 11 blade to remove the covering from the hole. The plastic tube guide is located approximately 9-inches (230mm) from the rudder hinge line. The tube should run perpendicular to the rudder hinge line.



- 5. Using pliers, thread a rigging coupler approximately halfway into a ball link. Take a section of pull-pull cable and route it through a small piece of shrink tubing, followed by a cable crimp. Then route the cable through the rigging coupler and back through the crimp. For extra security, you can loop the cable around the crimp a final time. Slide the crimp tight against the coupler and use a crimping tool to permanently attach the cable. Apply a small amount of thin CA to aid in securing the cable and crimp. Once secure, slide the heat shrink tubing back over the cable and crimp, and shrink it in place. The shrink tubing is only used to keep the cables looking neat and prevent the wire from snagging on any objects. Repeat this process for the second cable side.
- 6. Thread a rigging coupler approximately one-third of the way into your final two ball links. Secure the ball link and rigging coupler assembly to each side of the rudder servo arm. The order of hardware is as follows:
  - M3x15 Socket Head Cap Screw
  - M3 Washer
  - Ball Link (with rigging coupler)
  - Servo Arm
  - M3 Washer
  - M3 Lock Nut

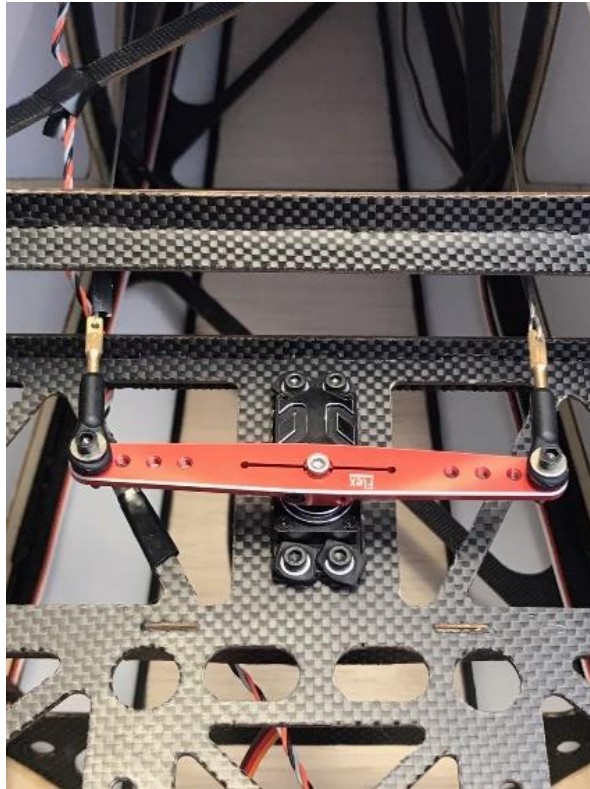

- 7. Route the pull-pull wire through the fuselage and out the exit holes located in step 4. Be sure to route the cables so that they do not tangle or cross. The cables should route straight from the servo arm to the exit of the fuselage.
- 8. Attach the ball link to the rudder control horn using a 2.5mm hex driver and a 5.5mm nut driver. Use the same order of hardware as done with the aileron control horns.
- 9. Power on your radio system and make sure the servo arm is perpendicular to the servo case. Route a cable through a piece of heat shrink, through a crimp and then through the rigging coupler mounted to the servo arm. Route the cable back through the crimp. For extra security, you can loop the cable around the crimp a final time. Repeat for the other pull-pull cable.
- 10. Pull the cables tight, while keeping the rudder centered. Once happy with the centering of the servo with the cables tight, use a crimping tool to permanently attach the crimp to the cables. Apply a small amount of thin CA to the cable and crimp joint for extra security. Once the CA has fully cured, slide the heat shrink over the joint and shrink it to secure it in place.



- 11. Adjust final cable tension by removing the ball links and by threading the rigging coupler further into the ball link. Start with the side that was only threaded one-third of the way into the link. Be sure to keep the rudder centered in the process. Do not over tighten the cables. Note that the cables will stretch slightly in the first twenty flights and will need to be subsequently retightened.

### **PUSH-PULL SYSTEM**

It is extremely unlikely that you will use the pull-pull system with the recommended equipment. However, should you choose to use a different engine, exhaust system, spinner or other components, the CG can be easily altered. For this reason, we have provided a rudder servo mounting location at the rear of the fuselage. There are two locations, one on each side of the fuselage. If you decide to use a push-pull system with the recommended setup, expect to add significant weight to the nose of the aircraft.



- 1. Locate the rudder servo bays in the rear of the fuselage. They are located about 1-inch (25mm) below the rear stab mounting screw and 3-1/2-inches (90mm) forward of the rudder hinge line. Choose which side you wish to mount the servo to and use a hobby knife with a fresh #11 blade to remove the covering, leaving approximately 1/8-inch (3mm) extra covering over the inside of the pocket. Use a covering or trim iron to seal the covering into the slot.



- 2. Use a #1 Phillips screwdriver to thread a servo mounting screw into each of the pre-cut holes in the servo mounting rails. Remove the screw and apply a small amount of thin CA to each of the holes to harden the threads cut by the screw. Let the CA fully cure before proceeding.
- 3. Attach a 48-inch (1250mm) servo extension to the servo. Use thread or heat shrink tubing to secure the extension in place. Route the servo extension through the holes in the formers as shown in the picture above.
- 4. Install the servo into the pocket with the output shaft facing the front of the airplane. Power on your radio system and center the servo as done previously.
- 5. Install a 2-inch servo arm onto the servo, making sure it is perpendicular to the servo case, and oriented towards the bottom of the fuselage. Apply a small drop of blue thread lock to the servo arm screw and secure it in place. If your servo arm has clamping screws, apply blue thread lock and secure them in place as this time.
- 6. Using a pushrod of 4-5/16-inches (110mm) in length, assemble the rudder linkage so that the total length from center of ball to center of ball is approximately 5-1/2-inches (140mm). Final length will be adjusted once the linkage has been attached to the servo and control horn.
- 7. Install the ball linkage to the servo arm and control horn as done with the previous linkage connections. Use a 2.5mm hex driver and 5.5mm nut driver to secure the hardware in place.
- 8. With the radio powered on, make any final adjustments to the linkage length to center the rudder accordingly.

## RUDDER AND LINKAGE INSTALLATION

### Required Components

- Elevator Control Horn (4)
- Control Horn Base (2)
- Left and Right Horizontal Stabs

### Required Building/Adhesive Materials

- Isopropyl Alcohol
- 30-Minute Epoxy

### Required Tools

- Hobby Knife with a #11 Blade

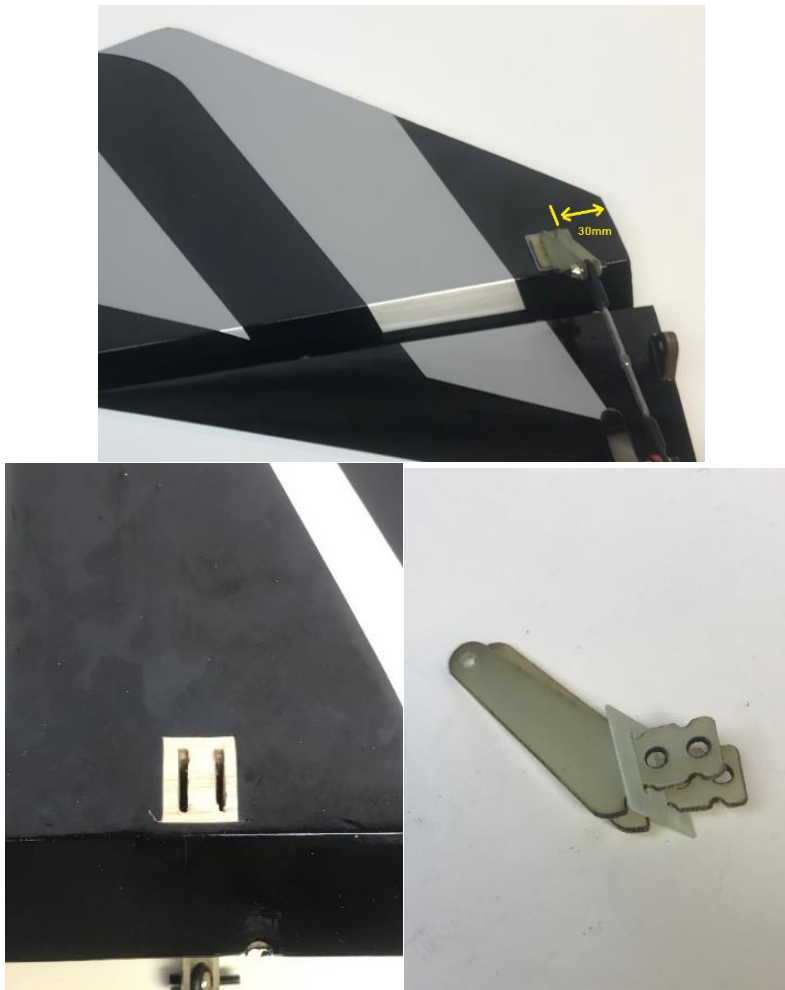

- 1. Use a hobby knife with a #11 blade to remove the covering from the bottom side of the elevators. The control horn slots are approximately 1-1/8-inches (30mm) from the elevator edge as shown in the picture.
- 2. The elevator and rudder control horns are the same. Prepare the control horns by scuffing the portion of the control horn the extends into the control surface with medium grit sandpaper. Use isopropyl alcohol and a paper towel to remove any excess debris from the control horn.

- 3. Mix an adequate amount of 30-minute epoxy. Apply epoxy to the control horn slots in the elevator as well as the control horn. Push the control horns into the slot, being sure to wipe away any excess epoxy with isopropyl alcohol and a paper towel.

**Quique's Tips:**

- To better help align the control horns with one another, use the provided hardware to secure the control horns to the ball link. This will keep them aligned while they are glued in place.
- The aileron control horns are pre-installed by the factory and a great reference point. Reference these if you have any questions about these steps.

**ELEVATOR SERVO AND LINKAGE INSTALLATION**

**Required Components**

- Horizontal Stabilizer Assemblies (2)
- Horizontal Stabilizer Carbon Fiber Tube
- Fuselage
- Elevator Servo (2)
- Elevator Servo Arm (2)
- 48-inch (1250mm) Servo Extension (2)
- Left and Right Horizontal Stabs
- M3x15 Socket Head Cap Screw (8)
- M3 Washer (8)
- M3x12 Washer (4)
- M3 Lock Nut (4)

**Required Tools**

- 2.5mm Hex Driver
- 5.5mm Nut Driver
- #1 Phillips Screwdriver

**Required Building/Adhesive Materials**

- 1. Use a #1 Phillips screwdriver to thread a servo mounting screw into each of the pre-cut holes in the servo mounting rails in the horizontal stabilizer. Remove the screw and apply a small amount of thin CA to each of the holes to harden the threads cut by the screw. Let the CA fully cure before moving forward.



- 2. Insert the elevator servo into the mounting location with the output shaft towards the horizontal stab tube. Mount the servo to the stab using the mounting screws provided with your servos. Note that the servo wire will exit on the front side of the servo.



- 3. Power on your radio system to center the servo. Install a 2-inch (51mm) servo arm onto the servo. Apply a small amount of blue thread lock to the servo arm screw and secure it in place. If your servo arm has clamping screws, apply blue thread lock to these screws and secure them in place. Note that you may need to power off the model and rotate the servo arm by hand to have access to each screw.
- 4. Using a pushrod of 2-3/4-inch (70mm) length, assemble the elevator linkages and ball links so that the total length from center of ball to center of ball is approximately 3-7/8-inches (98mm). Final length will be adjusted when centering the control surface. Note that the ends of the elevator linkages use threads of opposite directions.
- 5. Attach the linkage to the servo arm. The correct hole location is 2-inches (51mm) from the center of the servo arm. If you are using the recommended servo arm, this is the outermost hole. The order of hardware components, starting from the top of the servo is as follows:
  - M3x15 socket head cap screw
  - M3 washer
  - Ball Linkage
  - Servo Arm
  - M3 washer
  - M3 locknut
- 6. Attach the linkage to the control horn. The order of hardware components, starting from the tip of the stabilizer is as follows:
  - M3x15 socket head cap screw
  - M3 washer
  - Control Horn #1
  - Ball Linkage
  - Control Horn #2
  - M3 washer
  - M3 locknut
- 7. With the radio powered on and the servo centered perpendicular to the servo, adjust the linkage length so that the control surface is centered.

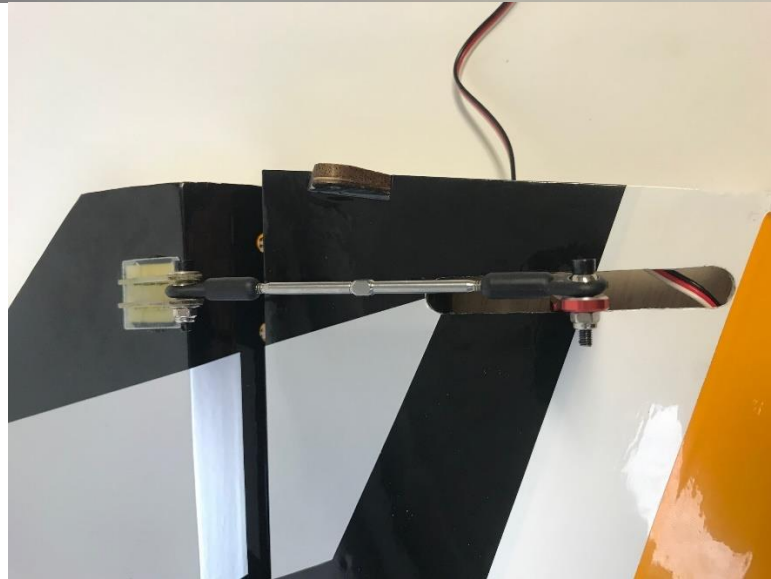

- 8. After installation is complete, your linkage setup should match the images above. Repeat the same procedures for the other horizontal stabilizer.

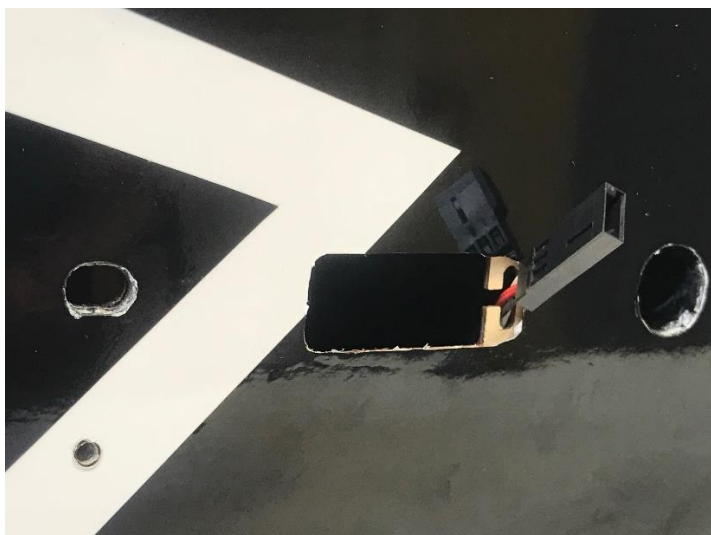

- 9. Use a hobby knife with a number 11 blade to open the hole for the servo wire as shown in the image above. Route a 48-inch (1250mm) servo extension through the holes in the corners of the formers to keep them from shaking around inside the fuselage. Place the female end of the servo extension in the retention slot cutout. This will prevent the extension from falling back into the fuselage.



- 10. Insert the carbon fiber horizontal stab tube into the appropriate hole in the fuselage and approximately center it left and right. Slide the left horizontal stabilizer onto the carbon tube and connect the servo extension to the servo. Use a 2.5mm hex driver to secure (2) M3x15 socket head cap screws and (2) M3x12 flat washers in place.

#### **Quique's Tip**

Before installing the horizontal stabilizer screws, apply a small amount of blue thread lock onto each screw. Install the screw and allow the thread lock to cure. Even if you plan to remove the horizontal stabilizers for transport, this thread lock will stay on the screw and help act as a vibration dampening material that will help prevent the screw from backing out in flight.

## LANDING GEAR INSTALLATION

### Required Components

- Fuselage Assembly
- Wheel Pant (2, L & R)
- Main Wheel (2)
- M5x20 Socket Head Cap Screw (4)
- M5 Flat Washer (2)
- M5 Lock Nut (6)
- M3x15 Socket Head Cap Screw (4)
- M3 Flat Washer (4)
- Landing Gear Axle (2)
- M5 Lock Collar (4)

### Required Tools

- 1.5mm Hex Driver
- 2.5mm Hex Driver
- 4mm Hex Driver
- 8mm Open End Wrench
- 10mm Open End Wrench
- 13mm Open End Wrench
- Felt-Tipped Pen
- Flat File

### Required Building/Adhesive Materials

- Blue Thread Lock



- 1. Assemble the axle to the landing gear leg. Use one 5mm flat washer between the lock nut and the landing gear leg as shown above. Fully tighten using a 10mm and 13mm open end wrench.



- 2. Temporarily slide a lock collar onto the axle, followed by the wheel and a second lock collar. Align the outside wheel collar so that it is approximately 3/32-inch (2mm) from the end of the axle and temporarily secure it in place with a 1.5mm hex driver. Press the inside lock collar against the wheel and temporarily secure it in place. Use a felt-tipped pen to place a mark on the inside edge of the inner lock collar and the outside edge of the outer lock collar. Remove both lock collars and the wheel from the axle.



- 3. Use a flat file to make two flat spots on the axle for the set screws to tighten against. Keep in mind that the marks made were on the outside edge of the collar, not the center so you will need to offset your file from these marks. Do not remove a lot of material as it will weaken the axle. You only need a small flat spot for each set screw.



- 4. Re-assemble the lock collars and wheel as done in step one. Use blue thread lock on the set screw and tighten the lock collar down. Be sure to orient the collars so that the narrow side of the collar faces the wheel. Ensure the wheel spins freely when complete.

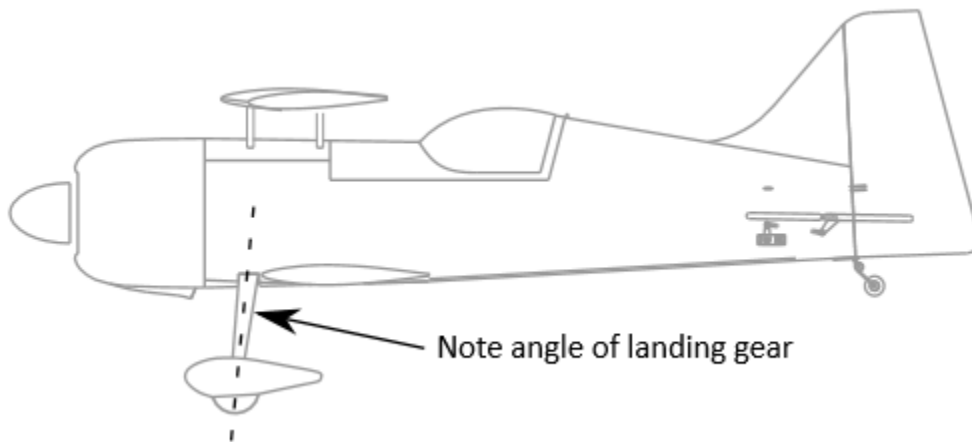

- 5. Install the wheel pants using a 2.5mm hex driver, M3x15 socket head cap screw and M3 washer. Apply blue thread lock to the screw before securing in place. Be sure to note that the landing gear sweeps forward as it moves away from the fuselage. The wheel pant mounting holes are specific to a side.



- 6. With the fuselage inverted on your workspace, place the landing gear on the fuselage so that it sweeps forward as it moves away from the fuselage. Place an M5x20 socket head cap screw with an M5 washer through the landing gear and through the landing gear mount in the fuselage. Note that there are not threads in the aluminum angle mount in the fuselage. Place an M5 washer over the screw, followed by an M5 lock nut. You may need to use needle nose pliers to more easily access the screws from inside the fuselage. Tighten the screws using a 4mm hex driver and an 8mm open end wrench. Do not fully tighten until all four M5 screws are in place, and the M5 lock nuts have been started.

## ENGINE INSTALLATION

### Required Components

- Fuselage Assembly
- Engine
- Engine Standoffs (20mm for DA120)
- 1/4-20 Blind Nut (4)
- 1/4-20 x 1-1/2-inch Socket Head Screw (4)
- 1/4-inch flat washer (4)
- 1/4-inch fender washer (4)

### Required Tools

- Drill
- 1/8-inch (3mm) Drill Bit
- 5/16-inch (8mm) Drill Bit
- 1/4-inch Hex Driver

### Required Building/Adhesive Materials

- Blue Thread Lock

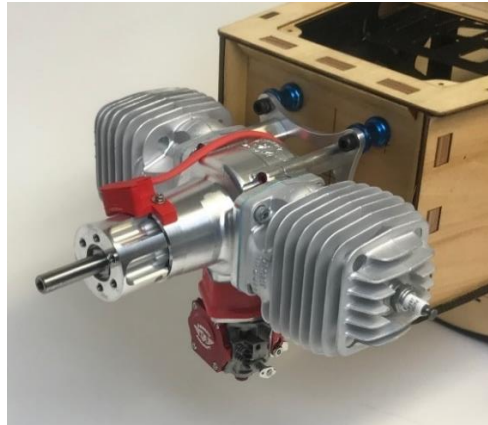

- 1. The engine mounting locations for the DA-120 is laser-etched into the firewall for your convenience. If using a different mounting pattern, the "X" represents the engine crankshaft. Use a 1/8-inch drill bit and drill to create a pilot hole in the center of the four bolt hole etchings in the firewall. Use a 5/16-inch drill bit to enlarge these holes. Verify that the hole is large enough to accommodate the blind nuts which will be installed in the next step.
- 2. Use a 1/4-20 x 1-1/2-inch screw, 1/4-inch flat washer, and 20mm standoff to pull the blind nut into the back side of the firewall. Once fully seated into the firewall, you may apply some medium CA to help secure the blind nut. Let the CA fully cure before moving to the next step.
- 3. Mount the engine (without the exhaust) to the firewall using (4) 20mm engine standoffs, (4) 1/4-20 x 1-1/2-inch socket head cap screws and (4) 1/4-inch flat washers. Be sure to apply blue thread lock to the motor mount screws. The order of components is as follows:

1/4-20 x 1-1/2-inch Socket Head Cap Screw  
1/4-inch flat washer  
Engine  
20mm Engine Standoffs (for DA-120)  
1/4-inch Fender Washer  
Firewall  
1/4-20 Blind Nut

### Quique's Tip:

The idea of using a fender washer between the engine standoffs and firewall is to increase the surface area of the joint between the standoffs and firewall. This not only helps prevent compression of the standoffs into the firewall, but also keeps the engine from flexing and moving around.



## THROTTLE SERVO INSTALLATION

### Required Components

- Fuselage Assembly
- Throttle Servo
- 36-inch (900mm) Servo Extension
- 2mm White Ball Link
- M2x10 Phillips Head Screw (1)
- M2 Flat Washer (2)
- M2 Lock Nut (1)

### Required Tools

- Drill
- 1/8-inch (3mm) Drill Bit
- #1 Phillips Screwdriver
- Needle Nose Pliers
- Pliers

### Required Building/Adhesive Materials

- Blue Thread Lock
- Shrink Tubing or Thread

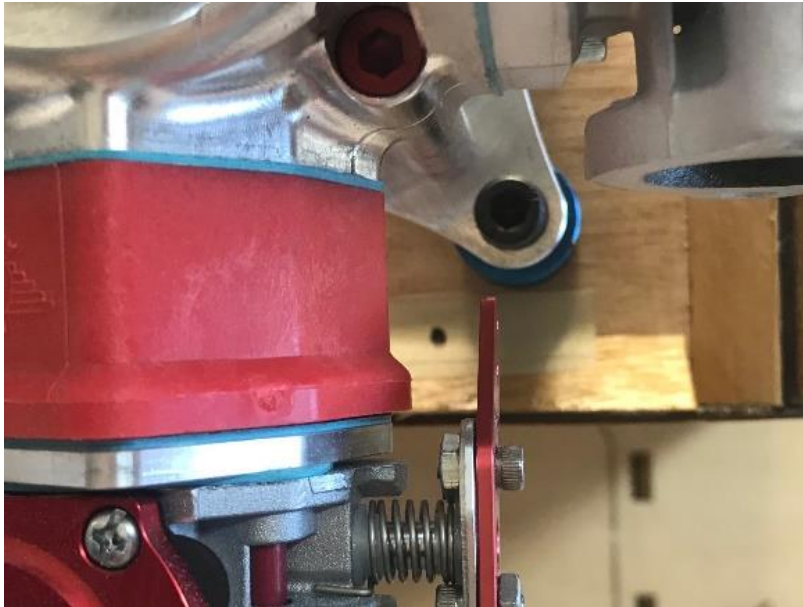

- 1. For the DA-120, use a drill and 1/8-inch (3mm) drill bit to drill a hole at the location shown in the above picture. This hole will be for the throttle linkage to pass through the firewall. Note: The large diameter fender washers are not shown in this image for clarity.

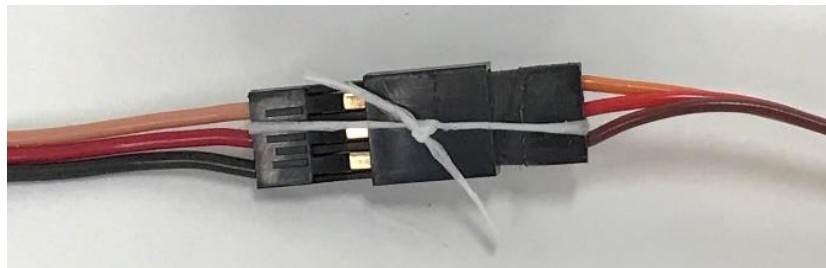

- 2. Secure a 36-inch (900mm) servo extension to the throttle servo. Use heat shrink tubing or thread to permanently secure the connection.



- 3. Install the throttle servo with the output shaft towards the tail of the aircraft. Use the radio system to center the servo, then install a  $\frac{3}{4}$ -inch (19mm) servo arm onto the servo. Make sure the servo arm is oriented to the side of the fuselage that provides the straightest geometry to the throttle arm on the engine. For the DA-120, the arm should be oriented to the left side of the fuselage if viewing the aircraft as the pilot. Do not secure the servo arm screw at this time.

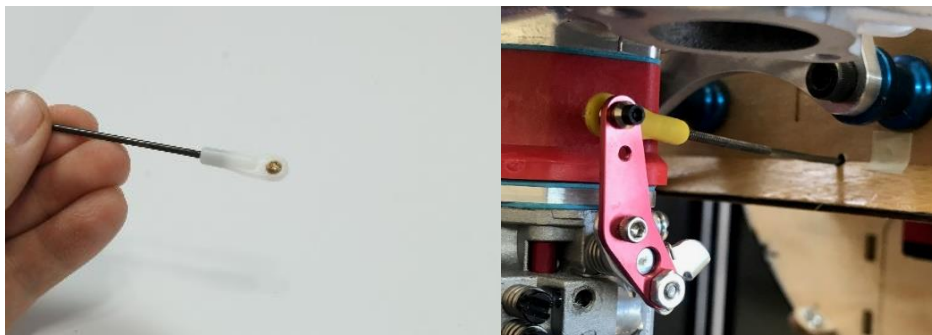

- 4. Locate the pushrod that is only threaded at one end. Thread the linkage approximately halfway into the M2 white ball link. Route the pushrod through the hole in the firewall made in step 1 and secure the ball link to your throttle arm using the M2x10 socket head cap screw, (2) M2 flat washers and M2 locknut. The order of these components should be as follows:

M2x10 Phillips Head Cap Screw  
M2 Flat Washer  
Engine Throttle Arm  
M2 Flat Washer  
M2 Lock Nut

Do not use thread lock on this connection, as it will weaken the plastic in the lock nut.

- 5. Use the radio system to center your throttle servo and manually center the throttle arm on your engine. Line up the pushrod with the hole in the servo arm you wish to use. For the DA-120, this will be the  $\frac{3}{4}$ -inch (19mm) hole. Use a felt tipped pen to mark the pushrod where it crosses this hole in the servo arm. Use a pair of pliers to create a z-bend in the linkage. Remove the servo arm and route the z-bend through the proper hole in the servo arm. Place the arm back onto the servo with the servo and throttle arm centered. Use blue thread lock and secure the servo arm in place with the servo arm screw.

**Quique's Tips:**

- Use the shortest servo arm possible while still getting full throttle arm movement on your engine. Your throttle end points should be around 110-120% when finished with the installation. A faster servo (like the Potenza DS22209HV) with a shorter arm is preferred over a slower servo with a longer arm.
- For the most linear throttle response, adjust the throttle linkage length to balance the end points for your throttle servo. You do NOT want your end points to be mismatched (example: 60/120). Get your end points as close to one another as possible (example: 114/116) for the best throttle response.

## IGNITION INSTALLATION

### Required Components

- Fuselage Assembly
- Ignition
- Ignition Switch
- Ignition Battery
- Regulator (if applicable)

### Required Tools

- Hobby Knife w/#11 Blade
- Rotary Tool
- Rotary Tool Cut-Off Wheel
- ¼-inch (6mm) thick Foam Sheet

### Required Building/Adhesive Materials

- Hook and Loop Strap
- Adhesive-Back Hook and Loop Tape
- ¼-inch (6mm) Thick Foam Sheet



- 1. Remove the forward hatch by sliding it aft and then lifting straight up. Locate the ignition switch hole towards the nose of the fuselage. Note that there are switch locations on both sides of the fuselage for your preference. Use a hobby knife with a #11 blade to remove the covering from the hole of your choice. Test fit your switch and modify the hole if needed to fit your switch. Secure your switch in place using the screws provided by your switch manufacturer. If your switch mounting screws thread into metal, be sure to apply blue thread lock. DO NOT apply blue thread lock if they thread into plastic.

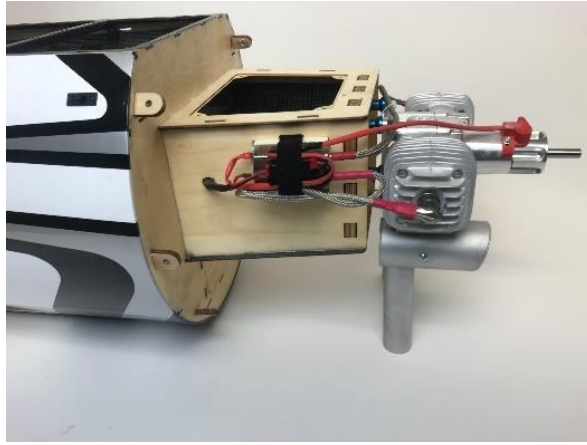

- 2. The ignition can be mounted where you prefer. We have found with the DA-120 that the above location works well. There are many ways to install an ignition and we recommend you mount it per your engine manufacturer's instructions.
- 3. The ignition can be mounted where you prefer. We have found with the DA-120 that the above location works well. There are many ways to install an ignition and we recommend you mount it per your engine manufacturer's instructions.

**Quique's Tip:**

Over the years, I have found that the below described system provides a solid mounting platform, while still providing enough dampening from vibration. Mount as you prefer, but this works very well and is a proven method for a long-lasting mounting solution.

- 4. Once you've decided where to mount the ignition, you need to make 2 slots for the hook and loop straps to pass through the motor box. Use a felt-tipped pen to mark each side of the ignition you want the strap to pass through. Use a rotary tool with a cutoff wheel (or rotary bit of your choice) to make the slots in the motor box. Keep these slots as small as possible to prevent weakening of the motor box.
- 5. Cut a piece of ¼-inch (6mm) soft foam to the size of the ignition. Apply adhesive-backed hook and loop tape on the ignition and both sides of the foam rectangle. Stick the foam to the ignition. Apply another piece of adhesive-backed hook and loop tape to the motor box where you will mount the ignition. Make sure it is the opposite type when compared to the hook and loop on the ¼-inch foam. Stick the ignition and foam assembly to the motor box and strap it to the motor box using hook and loop strap. Tighten the strap around the ignition so that it is firm and relatively tight. Don't tighten as tight as you can, as you do want some dampening in the foam from vibration.

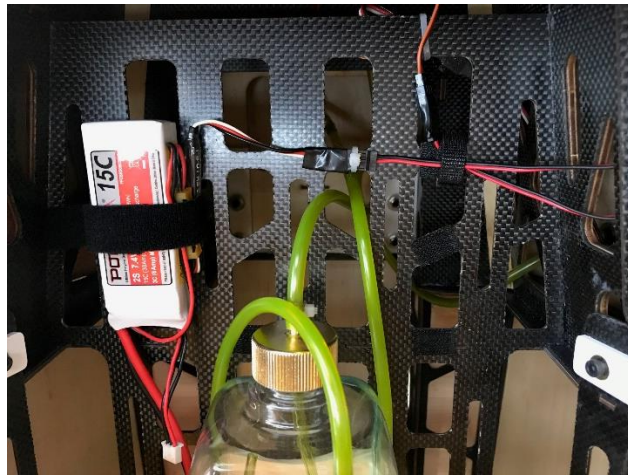

- 6. Place your ignition battery inside the fuselage as shown in the above picture. Use adhesive-backed hook and loop tape between the battery and the fuselage and secure the battery with a hook and loop strap.
- 7. Route all your wiring and make all electronic connections at this time. Secure any permanent connections with heat shrink tubing or thread. Be sure to secure the wiring so that it will not bounce around in the aircraft. Also be sure to secure the wiring in a way the wires will not chafe over time from vibration. A typical ignition setup will be connected as follows:

Ignition Battery > Ignition Switch > Ignition Regulator > Ignition

## FUEL TANK INSTALLATION

### Required Components

- Fuselage Assembly
- Fuel Tank
- Fuel Line

### Required Tools

- Pliers

### Required Building/Adhesive Materials

- Hook and Loop Strap
- Adhesive-Back Hook and Loop Tape

- 1. The fuel tank is assembled and ready to use. However, it is always a good idea to verify that the clunk is not too long. It should not touch the back of the tank when you hold the fuel tank vertically. Be sure you have about 1/4-inch (6mm) between the end of the clunk and the back of the fuel tank, as the clunk line will expand and lengthen a little with use.

### Quque's Tip:

Check the fuel tank for leaks. Loosen the fuel cap and re-install it until you feel it is well sealed. Plug the three fuel fittings on the tank. This can be done by cutting a small piece of fuel tubing and placing it over each fuel fitting on the tank. Fold or kink each piece of fuel tubing in half and wrap a zip tie around the fold. Apply a small amount of a soap/water mixture to the fuel cap area, as well as where the fittings mount in the tank. Apply a small amount of pressure to the tank (this can be done by lightly squeezing the tank) and check for any air bubbles in the soap/water mixture.

- 2. The fuel tank has 3 fuel fittings. The fitting in the cap is the main clunk line that will go to the carburetor or throttle body on your engine. One of the upper fittings has a small piece of fuel line attached to it inside the tank. This is your fill and empty line. It will be connected to your fuel dot and is where you will be filling or removing fuel from your tank. The last is the vent line and it is used to allow the tank to vent and “breathe” properly.

Cut a piece of fuel tubing a decent amount longer than needed for all your connections. Keep in mind that the vent line will need to wrap around the tank once before exiting the fuselage. Connect these fuel lines to the fuel fittings on the tank. Secure the fuel line to these fittings using safety wire or cable ties as desired.



- 3. The fuel tank tray has plenty of room for your fuel tank. If you are using a single tank, you can place the fuel tank in the middle of the tray as shown in the image above. If you plan to use a smoke system, two of these fuel tanks will fit side-by-side. You can use one for fuel and the other tank for smoke fluid. Apply adhesive-backed hook and loop tape to the bottom of your tank(s) and to the fuel tank tray. Place the tank(s) in place and secure them with two hook and loop straps. These straps should be snug but not overly tight, as the fuel tanks are very lightweight and can be easily crushed. The hook and loop tape on the bottom of the tank(s) will prevent the tank from moving fore and aft, and the hook and loop straps will prevent the tank from pulling away from the tray.



- 3. After the tank is in position, route and trim your fuel lines appropriately. Your clunk line should go to the carburetor or throttle body and the fill line should go to your fuel dot or filling system. The vent line should wrap around the back of the tank(s) and pass back in front of the tank(s). It should then exit the bottom of the fuselage as shown in the image above. After the vent line exits the fuselage, use a cable tie around the fuel line to prevent it from slipping back into the fuselage. Don't over-tighten the cable tie, as air and fuel will need to vent from this line. Be sure to keep your fuel line away from components that get hot (like your exhaust or cylinder heads) and route it in such away that it will not bounce around or chafe on any of the interior structure of the fuselage.



## EXHAUST AND COWLING INSTALLATION

### Required Components

- Fuselage Assembly
- Cowling
- Cowling Baffles
- Muffler (or Canisters/Headers)
- Exhaust Gasket (2)
- M4 x 20 Socket Head Cap Screw (6)
- M4 Flat Washer (6)
- M3 x 15 Socket Head Cap Screw (6)
- M3 Flat Washer (6)
- M2.5 x 8 Wood Screw
- Motor Box Cover Plate

### Required Tools

- 3mm Hex Driver
- 4mm Hex Driver
- 2.5mm Hex Driver
- #1 Phillips Screwdriver
- Rotary Tool
- Rotary Tool Sanding Drum
- Felt-Tipped Pen

### Required Building/Adhesive Materials

- Colored Silicone (Black typically preferred)
- Thin CA
- Medium CA
- CA Accelerator

**If you plan to use stock mufflers, please follow the instructions (A) below. If you plan on using canisters, please follow canister instructions (B) on the following pages. Be sure to follow the engine baffling instructions for both setups.**

### Muffler Installation (A)



- 1A. Temporarily install the bottom half of the cowling using (6) M4x20 socket head cap screws and (6) M4 flat washers. Estimate where the exhaust will exit the cowling and make a mark with a felt-tipped pen.
- 2A. Remove the lower half of the cowling. Install the muffler on the engine using the hardware provided by your engine manufacturer. Follow your manufacturer's installation instructions. Typically, most engines will use a gasket between the muffler and cylinder and the socket head cap screws will pass through a lock washer before securing the muffler to the engine.
- 3A. Use a rotary tool with a sanding drum to cut the holes in the lower cowling for each location the exhaust needs to exit the cowling. Test fit the cowling to be sure there is adequate gap between the muffler and cowling. We recommend at least 1/8-inch (3mm) gap.



- 4A. For stock mufflers on the DA-120 and similar engines, we recommend cutting cooling holes like the images above. Open the rear "lip" of the cowling as well as the additional holes per below. For the rear lip, be sure to leave approximately 3mm (1/8-inch) of vertical area to maintain strength in the cowling. Be sure to keep the corners round to help prevent cracking.

The center holes from front of the airplane to back are sized as follows:

1. 40 x 15mm (1-9/16 x 9/16-inches)
2. 65 x 15mm (2-9/16 x 9/16-inches)
3. 90 x 15mm (3-1/2 x 9/16-inches)

The side holes from front of the airplane to back are sized as follows:

1. 20 x 15mm (3/4 x 9/16-inches)
2. 40 x 15mm (1-9/16 x 9/16-inches)
3. 60 x 15mm (2-9/16 x 9/16-inches)

If you are using stock mufflers, **DO NOT** open holes in the bottom of the fuselage.

## CANISTER INSTALLATION (B)

For the DA-120, we recommend the use of (2) KS 3086 Canisters in conjunction with (2) MTW 70mm drop, flexible headers.

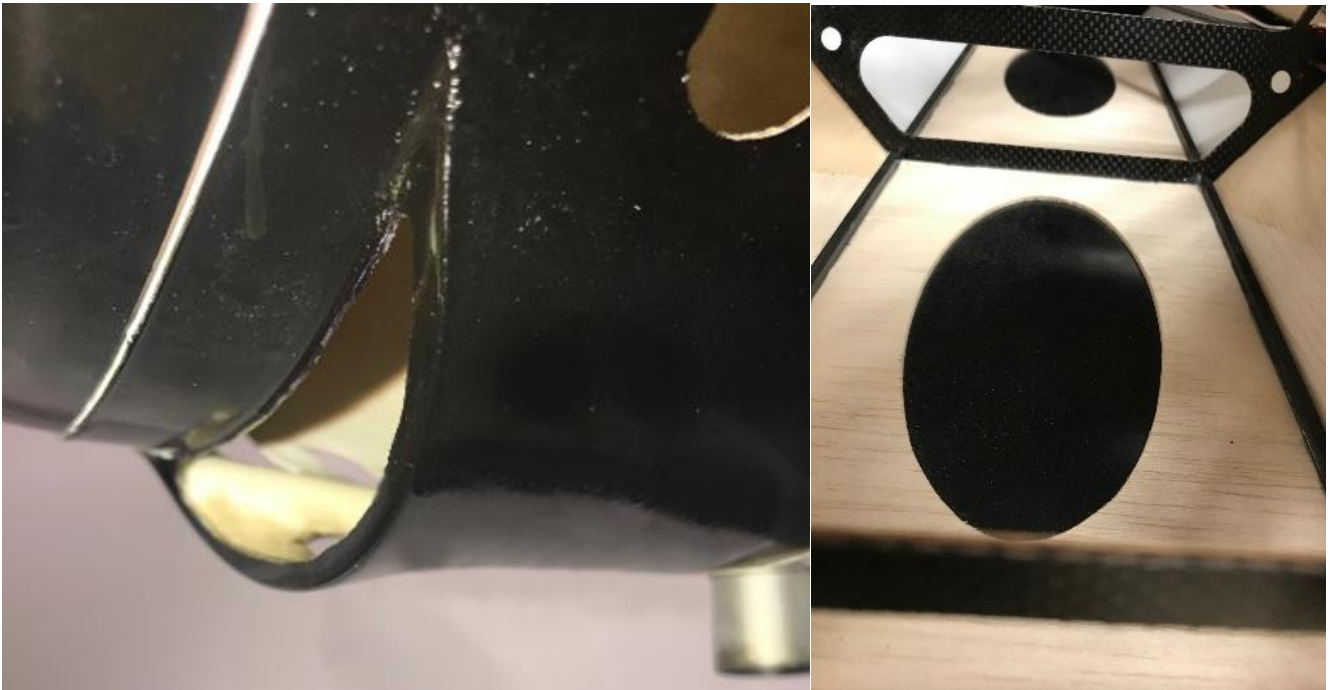

- 1B. For canisters on the DA-120 and similar engines, we recommend cutting one cooling hole in the cowling. Open the rear “lip” of the cowling with a sanding drum on a rotary tool as shown in the image above. For the rear lip, be sure to leave approximately 3mm (1/8-inch) of vertical area to maintain strength in the cowling. Be sure to keep the corners round to help prevent cracking.

For the fuselage, use a hobby knife with a #11 blade to open the two oval holes in the bottom of the fuselage. Be sure to leave about 1/8-inch (3mm) overlap so that you can iron the covering to the balsa sheeting on the inside of the fuselage. You may need to cut a few slits in the edge of the covering due to the curved shape of the holes. Apply some epoxy to the edges of the covering to help prevent oil and debris from getting under the covering.

You will also need to open a hole for the exhaust exit, but this may vary depending on your specific exhaust. Open a hole as needed and seal the covering as done with the pre-cut holes in the fuselage.

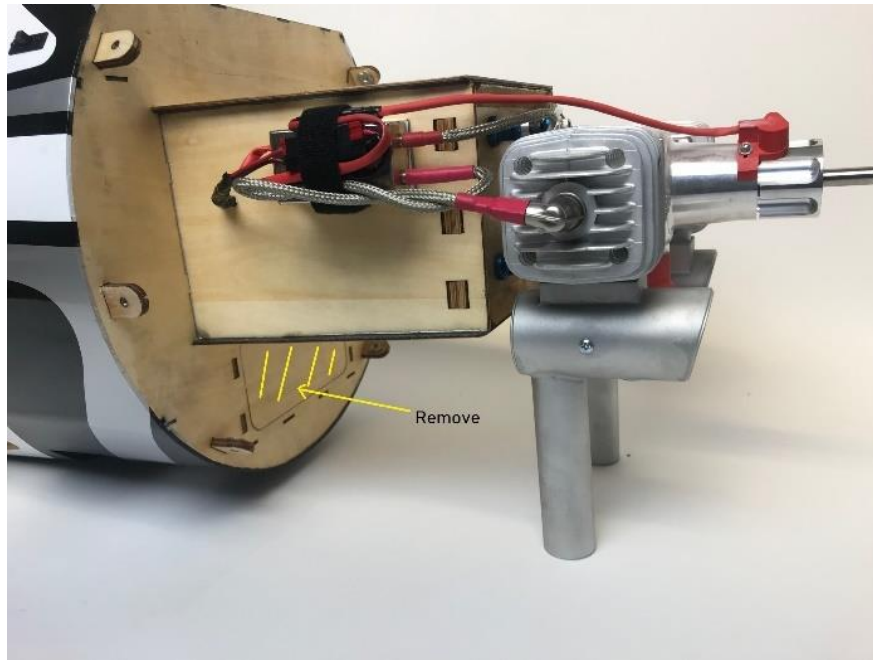

- 2B. Use a hobby knife with a #11 blade to remove the plywood plate from the front edge of the fuselage noted in the photo above.
- 3B. Insert the silicone tubing into the provided canister mount. If using a different canister, we suggest purchasing a mount from your canister or engine manufacturer.

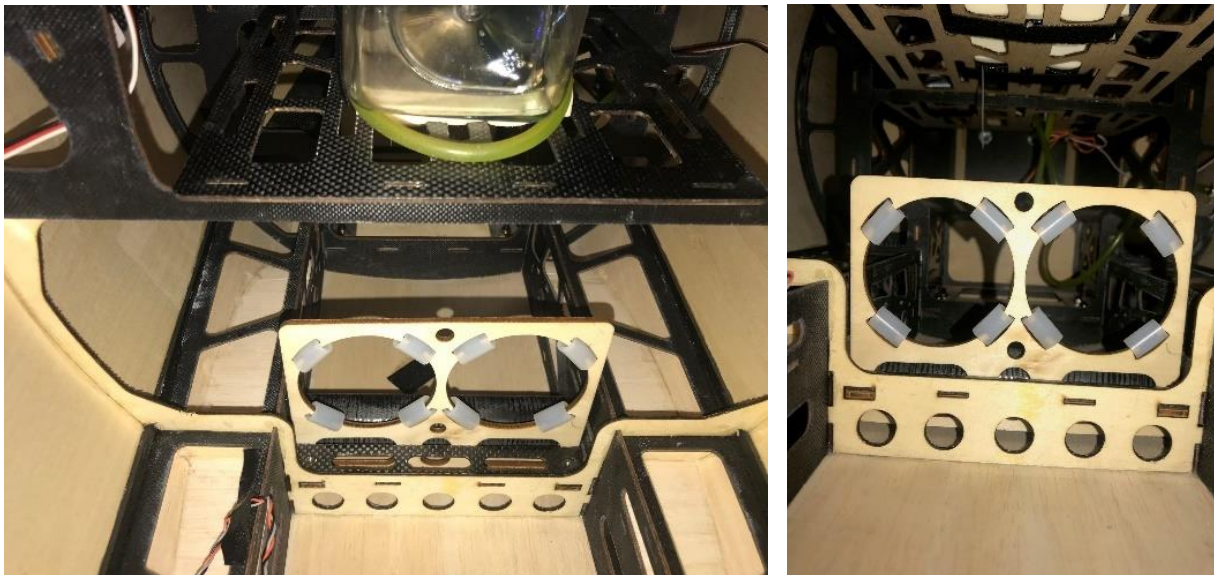

- 4B. Place the mount against the lower wing mounting bracket under the fuel tank tray as shown in the image above. Note that it installs forward of the lower wing mounting bracket. Do not glue into place at this time. Install the header and canister per your engine and exhaust manufacturer's instructions, placing the exhaust through the mount. Once the exhaust is mounted to the engine, use 30-minute epoxy to secure the canister mount in place.

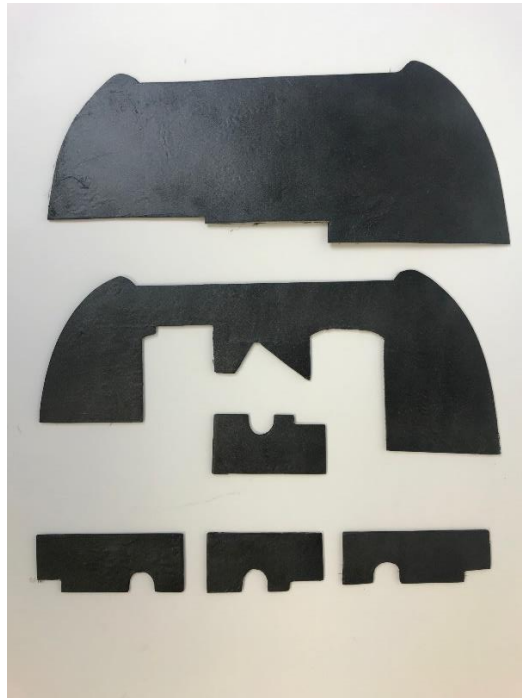

- 5. Locate the engine baffles. These are designed to fit the DA-120 and are marked with their proper locations. There still may be some fine tuning required, or if you are using a different engine, you can use these as a template or modify them as necessary. Modify them if needed at this time.

We recommend painting the baffles black to help hide them and keep everything clean in appearance when they are installed. You can paint them any color you'd like but be sure to use an enamel-based paint to help resist damage to the paint or wood when fuel or oil is spilled on the baffles.

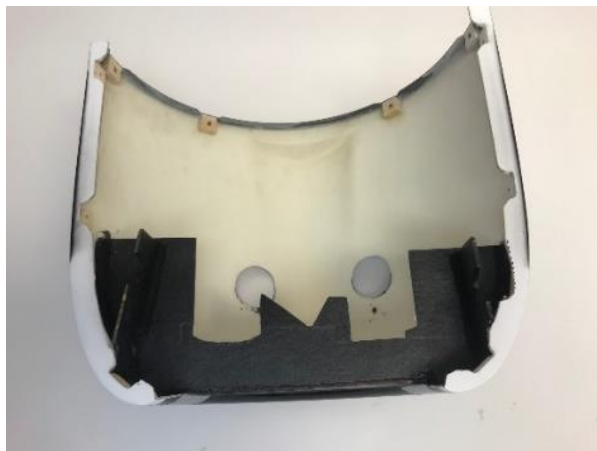

- 6. Using medium CA, tack the lower baffle in position. The top of the baffle should be flush with the top of front opening, and perpendicular to it as well.
- 7. Place and glue each of the lower side baffles as shown. Note the angle to clear the spark plug.

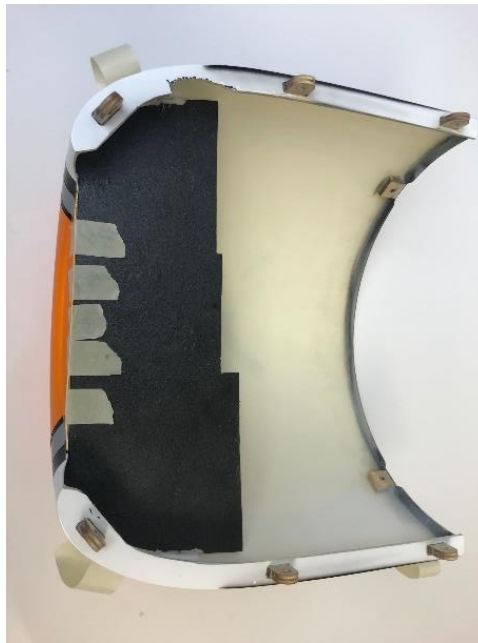

- 8. Using medium CA, tack the upper baffle in position. The bottom of the baffle should be flush with the bottom of the front opening, and perpendicular to it as well.

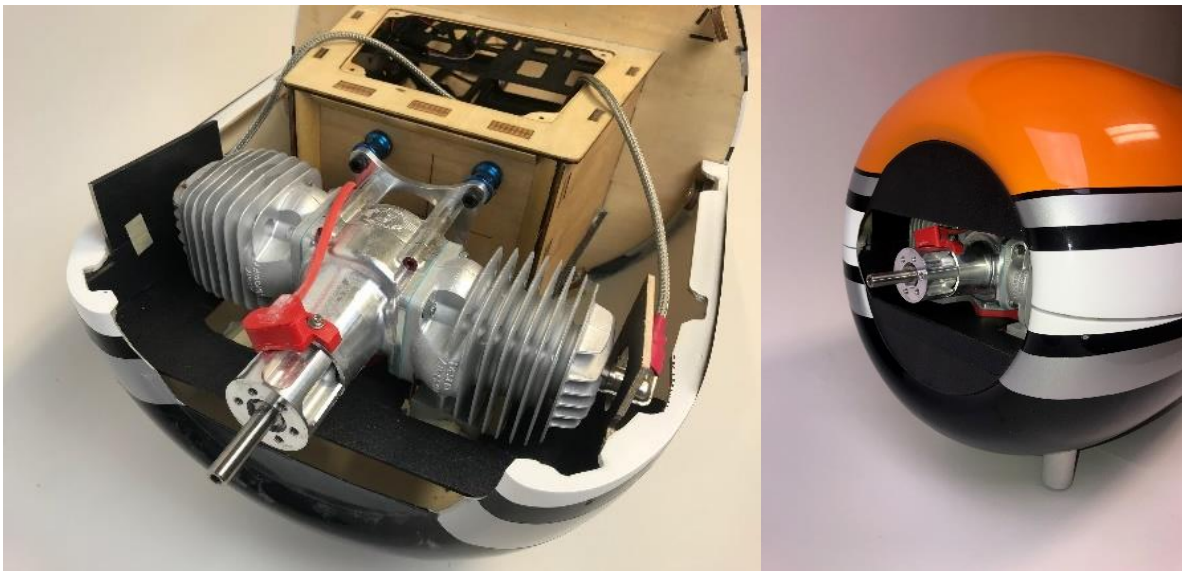

- 9. Temporarily install the lower half of the cowling. Use low-tack tape to secure the upper side baffles into position, taping and matching them to the lower side baffles. Apply medium CA to the top of the upper side baffles. Place the upper half of the cowling in place and allow the upper side baffles to touch the upper baffle. You can use accelerator here but be sure to let the CA fully cure.

This process can take some time to install and uninstall the cowling to check fit. Be patient and do not rush the process.

- 10. Using colored silicone (we use black so that it matches the baffling appropriately), cover all the joints on the inside of the cowling to permanently fix it in place. Let the silicone cure per the manufacturer's recommendations. We choose to use silicone due to the high vibration in this area.

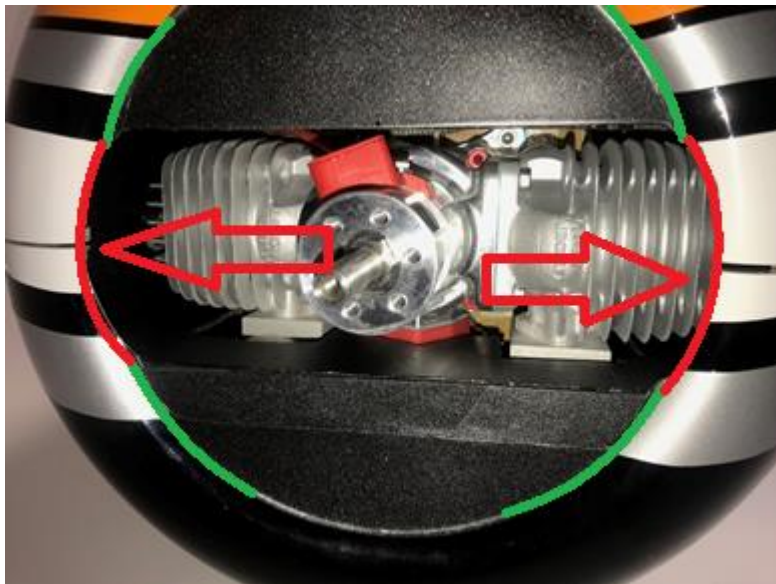

- 11. Once the silicone has fully cured, use a rotary tool and sanding drum to open the sides of the fiberglass cowling. This will allow a bit more airflow to the cylinder heads. You should open this to the edge of the front mounting block for the forward-most cowling screws.
- 12. Install the choke linkage with your preferred method. We used a 2-56 ball link and 4-40 pushrod. You could also use a 2mm ball link and 2mm linkage found on many 60-class ARF or ARFSV aircraft. We leave the pushrod long until the cowling is installed and then trim it for the proper length. Be sure to make a hole in the cowling for the rod and use a grommet or piece of fuel tubing to serve as a guide for the rod and prevent any wear to your cowling.



- 13. Locate the motor box top plate and the (4) M2.5 x 8 wood screws. Use a #1 Phillips screwdriver to thread an M2.5 x 8 screw into each of the pre-cut holes in the motor box for the top plate. Remove the screw and apply a small amount of thin CA to each of the holes to harden the threads cut by the screw. Let the CA fully cure before proceeding.
- 14. Secure the top plate in place using a #1 Phillips screwdriver.
- 15. Once you are happy with the fit of your cowling, proceed to installing the lower half of the cowl. Use a 3mm hex driver, (4) M4 x 20 socket head cap screws and (4) M4 flat washers to secure it in place. Be sure to apply blue thread lock to each screw.
- 16. Before installing the top half of the cowling, verify that all spark plug wires, fuel lines and any battery or servo wires are properly installed and well-secured. Use a 3mm hex driver, (2) M4 x 20 socket head cap screws and (2) M4 flat washers to secure the rear section of the upper cowling to the fuselage. Use a 2.5mm hex driver, (6) M3x15 socket head cap screws and (6) M3 flat washers to secure the upper cowling to the lower cowling. Be sure to apply blue thread lock to each of the screws.





- 16. Install your propeller and spinner. For the DA-120, we recommend a Flex 27x10.8 carbon fiber propeller and a Falcon 5-1/2-inch (140mm) carbon fiber spinner.

## TOP WING CENTER SECTION INSTALLATION

### Required Components

- Fuselage Assembly
- Top Wing Center Section
- Center Cabane Struts (4)
- M4x15 Socket Head Cap Screw (8)
- M4 Flat Washer (8)
- M5x15 Socket Head Cap Screw (4)
- M5 Flat Washer (8)
- 18-inch (350mm) Servo Extensions (2)
- 36-inch (900mm) Servo Extensions (2)

### Required Tools

- 3mm Hex Driver
- 4mm Hex Driver
- Hobby Knife with #11 Blade
- Covering Iron or Trim Iron

### Required Building/Adhesive Materials

- Red Thread Lock



- 1. Locate the holes in the fuselage for the center cabane struts to pass through. Remove the covering from these holes using a hobby knife with a sharp #11 blade. Note that all center struts are identical. Insert a strut into the slot. Use a 3mm hex driver, (2) M4 x 15 socket head cap screws and (2) M4 flat washers to secure the strut in place. Use red thread lock on these screws. Repeat for the other three struts.



- 2. Locate the holes for the cabane struts in the bottom side of the top wing center section. Near the rear cabane hole, you will also find the hole for the aileron servo extension. Use a hobby knife with a sharp #11 blade to remove covering from these holes. Be sure to leave 1/8-inch (3mm) excess inside the hole. Use a covering or trim iron to seal the covering down into the hole.



- 3. Place the center section over the top of the cabane struts, being sure to orient the thicker side of the airfoil towards the nose of the aircraft. Use a 4mm hex driver, (4) M5 x 15 socket head cap screws and (4) M5 flat washers to secure the struts to the center section. Use red thread lock on these screws.
- 4. Route (2) 36-inch (900mm) heavy-duty servo extensions up the inside edge of the rear cabane strut and out the wing center section. Route the other end of the extension through the fuselage and to your receiver system. Secure the extensions to the cabane using cable ties or tape.

You can also route two 18-inch (350mm) extensions for the bottom ailerons at this time.

## RADIO GEAR INSTALLATION

### Required Components

- Fuselage Assembly
- Receiver
- Receiver Switch
- Aura Professional (Optional)
- Receiver Batteries
- Hook and Loop Straps
- Adhesive-Backed Hook and Loop Tape
- Tie-Wraps

### Required Tools

- Hobby Knife with #11 Blade
- 2mm Hex Driver
- #1 Phillips Screwdriver

### Required Building/Adhesive Materials



- 1A. If you are using an Aura Professional, it can be mounted forward of the rudder servo location as shown in the picture above. There are pre-cut holes to more easily start the mounting screws. **DO NOT** use hook and loop tape to mount the Aura.

Use a #1 Phillips screwdriver to thread an Aura mounting screw into each of the pre-cut holes in the mounting tray. Remove the screw and apply a small amount of thin CA to each of the holes to harden the threads cut by the screw. Let the CA fully cure before mounting the Aura and securing the (4) screws.

We also recommend using a small hook and loop strap as extra security to prevent the Aura from coming loose in the aircraft.

- 1B. If not using the Aura, choose a mounting location for your receiver. It can be mounted in the same location as the Aura in the image above if desired. Keep your CG in mind as well when choosing a mounting location. We recommend using hook and loop tape on the back of the receiver, as well as a hook and loop strap securing it in place.



- 2. Locate the receiver switch location just under the canopy, and just forward of the receiver and rudder servo tray. Note that there is switch locations on both sides of the fuselage. Remove the covering from the hole of your choice using a hobby knife with a #11 blade. Mount your switch, being sure to orient the on/off plate properly. If your switch mounting screws thread into metal fittings or nuts, be sure to use blue thread lock. If your switch mounting screws thread into plastic, DO NOT use thread lock as it may damage the plastic.

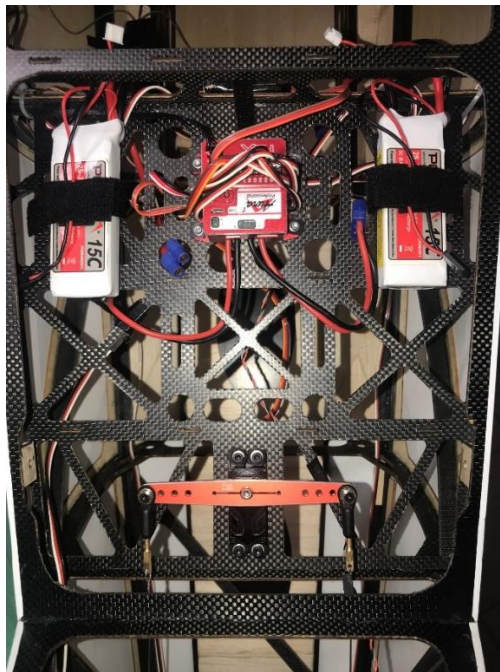

- 3. Make all necessary servo connections to your receiver and/or Aura. Install your two recommended batteries as needed to achieve the proper CG. The location shown above should get you very close to balancing properly if using all of the recommended equipment.

In the image above, we are using the Aura 8 Pro with dual Futaba SBus receivers. One is mounted to the belly of the aircraft and the other is mounted to the turtle deck in the back of the fuselage for maximum RF strength. Reference your receiver's instruction manual for mounting details.

## FIELD ASSEMBLY

### Required Components

- Fuselage Assembly (w/ hatches)
- Wing Assembly (4)
- Wing Tube (2)
- Horizontal Stabilizer Assembly (4)
- Horizontal Stabilizer Tube
- Interplane Strut (2)
- Interplane Strut Retention Pins (4)
- M4x15 Socket Head Cap Screw (4)
- M4 Flat Washer (4)

### Required Tools

- 3mm Hex Driver
- 2.5mm Hex Driver
- Pliers

### Required Building/Adhesive Materials

- 1. If you choose to remove the horizontal stabilizers for transport or storage, install the horizontal stabilizers as explained in the Elevator Servo and Linkage Installation Section of this manual.



- 2. Remove the rear canopy hatch from the fuselage. Slide a main wing tube into one lower wing panel. Note that both wing tubes are the same for the top wings and bottom wings. Partially slide the wing tube (with wing) into the lower wing tube socket. Secure the aileron servo lead to the servo extension and fully slide the wing into place, being sure to guide any servo extensions into the wing or fuselage so that they are not pinched between the wing and fuselage.
- 3. Secure the wing with an M4x15 socket head cap screw, M4 flat washer and your 3mm hex driver just behind the lower wing tube socket in the fuselage. Repeat this process for the other lower wing.



- 4. Follow the same basic steps for the top wings, noting that the M4x15 socket head cap screws are inserted from the bottom side of the wing.



- 5. Be sure the interplane strut retention pins are removed from the struts. Slide an interplane strut into place, noting its orientation and the side you are installing it on. The struts are directional and should only be mounted on one side and in one direction. Push the straight end of the strut retention pin through the strut, into the wing strut block and back into the strut. When fully installed, the angled portion of the strut pin should be against the strut. Repeat this process for the other side.

Note that pliers may need to be used if the pins have a tight fit. A tight fit is intentional, and it should be maintained as a tight fit as the holes loosen over time.



- 6. Place the canopy (and forward hatch if removed) onto the fuselage and secure the canopy with (2) M4x20 socket head cap screws (2) M4 flat washers and your 3mm hex driver.



## CENTER OF GRAVITY

Setting the center of gravity is one of the most important steps for success, particularly with a new airplane. The Flex Innovations Mamba 120cc is a high-performance airplane with large control surface throws, and a very high thrust to weight ratio. These two factors combined make the Mamba a very enjoyable aircraft to fly, but if the center of gravity is not within an acceptable range, it will make the airplane difficult, if not impossible, to control. In order to have the most success and enjoyment from your Mamba, please follow the next few steps very carefully.

Before balancing your model, please ensure that all the components are installed in your airplane when checking CG. This means the batteries, servos, linkages, hardware, propeller, spinner; everything. The airplane must be in ready-to-fly condition, otherwise the measurement will not be accurate. There are several methods for determining center of gravity, from using a CG machine, to using fingers and a friend. Regardless of the method used, ensure that the tests are accurate and repeatable. If there are any inconsistencies between measurements, work to isolate the source of the error(s) to ensure that the test can be repeated with the same results. If lifting the model by the wing tips, do NOT lift directly from the tip of the wing, but lift at the tip-most wing rib location or damage to the model may result.

**It was found that 4-1/2 in. (114mm) AFT from the LEADING EDGE of the BOTTOM WING to be an overall great CG. The center of gravity range is 105mm to 125mm. Depending on flying style, the pilot chose a CG with this range.** It is critical that the starting point for your model be at this point. This measurement is determined from many test flights by designer and multi-time world aerobatic champion, Quique Somenzini.

### Quique's Tip:

The CG can be easily achieved using the recommended equipment and placing it in the recommended areas. However, some variance of weight between models is possible. For this reason, it is recommended to leave the batteries uninstalled and install them where necessary to reach the recommended CG. There are two battery mounting locations in the aircraft. The front location is just ahead of the gas tank and the other is on the rudder servo and receiver tray just under the canopy. Use these locations to place your batteries.

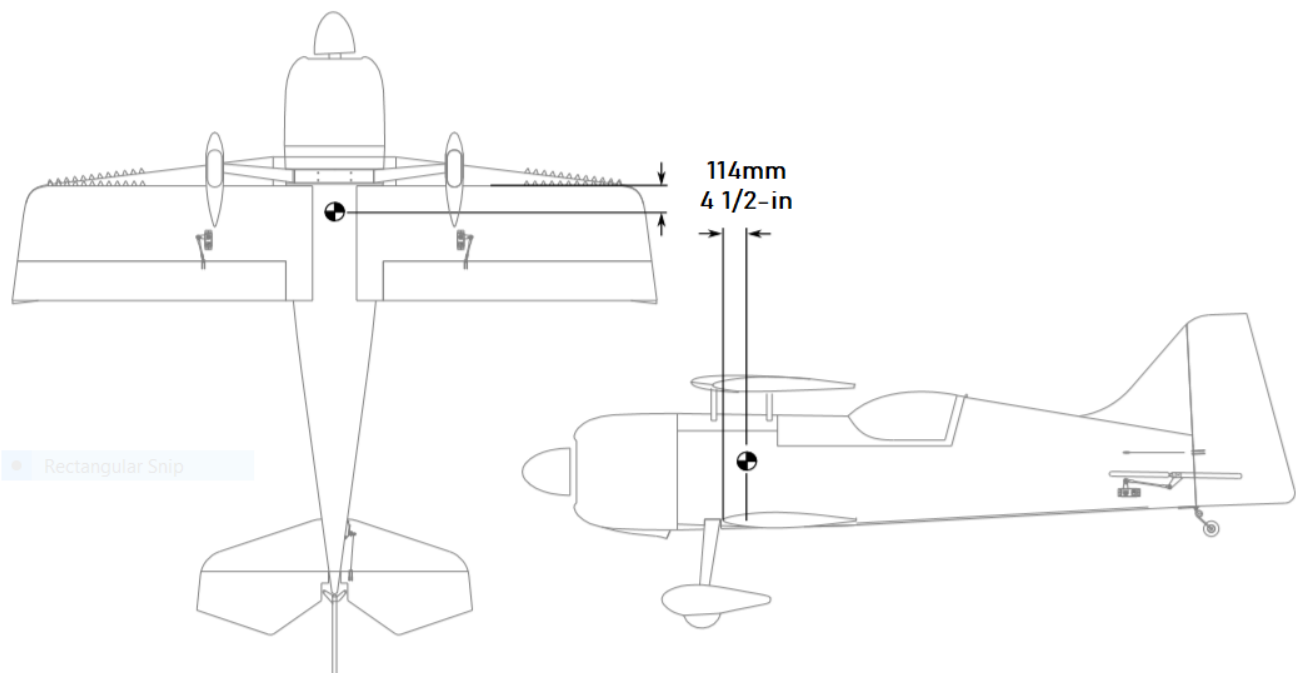

## DECAL INSTALLATION

Use the photos provided below, as well as the images on the box for a guide to apply decals to your model.

1. Thoroughly clean the model to ensure that it is free of oil, fingerprints, and dust.
2. Separate the decals, but do not remove the paper backing.
3. Prepare a dishpan or small bucket with a mixture of warm water and liquid dish detergent. The ratio should be approximately one teaspoon per gallon of water.
4. Submerge the decal into the water/soap mixture and gently remove the paper backing. Removing the backing under water prevents fingerprints from being visible on the back side of the decal
5. Apply some water/soap mixture with your palm to the area desired. Once the area is saturated, position the sticker on the airplane. Even though these are not water transfer decals, using wet application methods allows the sticker to be repositioned, reduces bubbles, and eliminates fingerprints and other blemishes from being visible.
6. Hold the decal in place and use a paper towel to gently wipe most of the water away.
7. Use a soft piece of balsa or similar and squeegee the remaining liquid from underneath the decal.
8. Repeat until all decals are applied. Do not move, or otherwise touch the model for at least 12 hours to allow the rest of the water to evaporate.

### Prop Selection

Prop has a great impact on the aircraft overall performance. If the aircraft it is going to be flown mainly for 3D flight, like tumbling and using prop gyroscopic maneuver, Quique recommends the Falcon 28x9.5 Carbon Fiber 2-Blade Propeller. If the aircraft would be flown mainly for IMAC flying style or highspeed flights, Quique Recommends the Flex 27x10.8 Carbon Fiber 2 Blade Propeller.

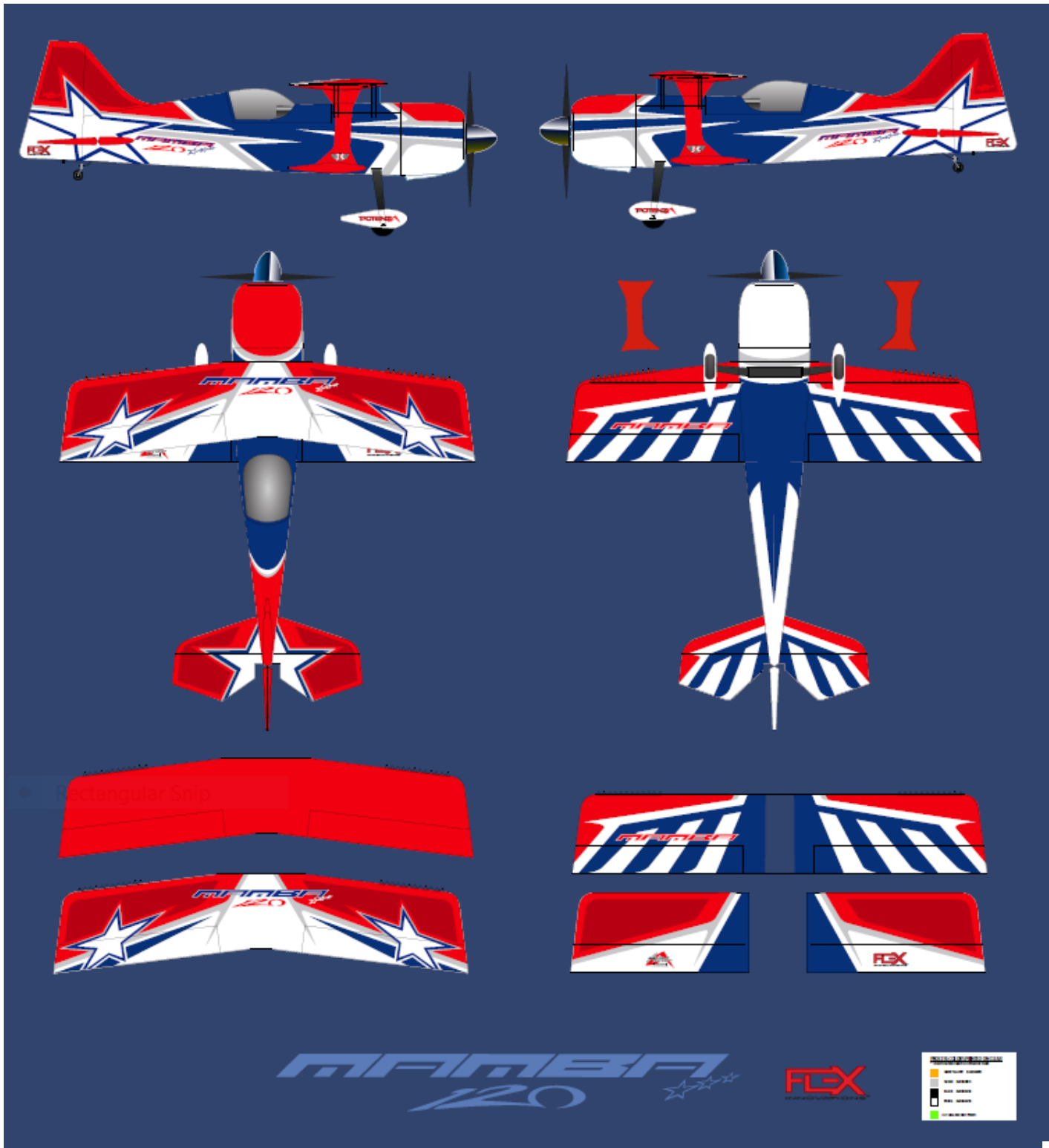

**AURA 8 PROFESSIONAL**

If you chose to use Aura 8 Professional, you can find all the information about the Mamba 120 Aura set up at:

<http://wiki.flexinnovations.com/wiki/Mamba120>

**STARTING CONTROL SURFACE THROWS AND EXPONENTIALS**

The following throws and exponentials have been tested thoroughly during the development of the airplane and have been determined to be the optimal starting point for the Mamba 120. As you become more familiar with the airplane, you may tweak the rates and expos to better suit your flying style but these numbers will be a very good starting point.

**IMPORTANT:** Control throws are measure at the widest point of each control surface, unless otherwise noted. Note that aileron deflections apply for all ailerons including top and bottom ailerons.

**NOTE:** Since expo directions vary by radio manufacturer, all expos listed below are those that make the feel softer around center.

**LOW RATE****HIGH RATE****AILERONS**

Up	2-7/32 in. (56mm)	3-15/16 in. (100mm)
Down	2-7/32 in. (56mm)	3-15/16 in. (100mm)
Expo	25%	45%

**ELEVATOR**

Up	2-3/16 in. (56mm)	11-13/32 in. (290mm)
Down	2-3/16 in. (56mm)	10-23/32 in. (270mm)
Expo	25%	40%

**RUDDER**

Left	3-9/16 in. (90mm)	10-7/32 in. (260mm)
Right	3-9/16 in. (90mm)	10-7/32 in. (260mm)
Expo	20%	45%

High rate should be reserved for 3D aerobatics and low rate should be reserved for precision aerobatics. It is highly recommended that for your first flights, take offs and landings be done in low rate. This is a very powerful and agile airplane and lesser experienced pilots taking off in high rate could over control the airplane and crash.

## RANGE TESTING

Carefully follow the binding and range testing instructions included with your radio equipment. If there are any issues passing the test range, please consult your transmitter and receiver manuals or contact your transmitter and receiver manufacturer to determine the appropriate solution before attempting to fly.

---

### BEFORE FIRST FLIGHT

Before your first flight, please go over the finished, fully assembled model at home before going out to the flying field. The key to a successful first flight is preparation and ensuring that your plane is airworthy.

- 1. For optimal performance of your model, balance your propeller and spinner. Most propellers are balanced fairly-well out of the package; however, some fine-tuning can make a mediocre propeller perform great. An out-of-balance propeller or spinner can wreak havoc on the electronic components in the airplane, as well as prematurely shorten the life span of the engine, servos or even the model itself. A balanced propeller will be quieter, generate more thrust and operate more efficiently than one that is not balanced.
- 2. Re-check all linkages and connections. Ensure pushrods are sufficiently threaded into ball links, ensure that all metal-to-metal connections have thread lock applied and ensure that all controls move freely and in the proper direction.
- 3. Verify proper function and operation of your engine choice. Ensure that the fuel-air mixture is correct and that the engine is making full power. If not familiar with gas engines, ask for the assistance of a more experienced pilot in your area or speak with your engine manufacturer.
- 4. Secure any loose wiring inside the fuselage or wings and be sure to secure them in a way that they do not rub or chafe.
- 5. Ensure that all batteries (transmitter, receiver, ignition) are fully charged prior to leaving for the flying field.
- 6. Take a few moments to assemble the airplane away from commotion or talkative onlookers. Ensure that all connections are properly made and secured, the wing bolts are tight and take a few minutes to plan out your first flight.
- 7. If your engine is new, avoid prolonged full throttle runs and vertical climbs. Limit the first few flights to a short flight time. Start off short, gradually lengthening the flight times as you become comfortable with the performance of your engine. Six minutes is a good time to limit your first flights to. As you become more familiar with the airplane and begin to fly it in a more aggressive manner, monitor the temperature of the engine and adjust the fuel-air mixture according to your engine manufacturer's recommendations.

## AMA SAFETY CODE

When flying your aircraft, we recommend following the guidelines set forth by the Academy of Model Aeronautics (AMA). You can find their Safety handbook as well as more information on the AMA at their website, located at the address below.

<https://www.modelaircraft.org/>

## OPTIONAL ACCESSORIES

<b>Part Number</b>	<b>Description</b>
FPZDS49010BLHV	Potenza DS49010 Brushless, High-Voltage, Titanium Gear Servo
FPZDS22209HV	Potenza DS2209 Coreless, High-Voltage, Titanium Gear Servo
FPZA1036	Aluminum Servo Arm, 2-inch, Clamping (25T)
FPZA1037	Aluminum Servo Arm, 4-inch, Clamping (25T)
FPZA1033	Mamba 120 Heavy Duty Servo Extension Set
FPZAURA08PRO	Potenza Aura 8 Professional AFCS
FPZAURA12PRO	Potenza Aura 12 Professional AFCS
FPMDA120	Desert Aircraft DA-120 120cc Gas Engine
FPMDA120MUFFLER	Desert Aircraft DA-120 Stock Muffler Set
FPMP27108GCF	Flex Innovations 27 x 10.8 Carbon Fiber 2-Blade Propeller
FPMPFC2895	Falcon 28x9.5 Carbon Fiber 2-Blade Propeller
FPMF55CF	Falcon 5-1/2-inch (140mm) Carbon Fiber Spinner
FPM1624	20mm Aluminum Engine Standoffs (4)
FPZBR20002S15	2S 2000mAh 15C Li-Po Receiver Battery
FPM1614	Mamba 120 Premium Wing and Tail Bag Set
FPM1628	Mamba 120 Stretch Fabric Sunshade
FPM1627	Mamba 120 Cockpit and Pilot Set
FPM1623	32oz Lightweight Tank
ISDTD2	ISDT D2 Charger
FPZA1010	Potenza Digital Battery Analyzer

## REPLACEMENT PARTS

Part Number	Description
-------------	-------------

### Both Schemes

FPM1607	Mamba 120CC C/F Landing Gear
FPM1609	Mamba 120cc Carbon Wing Tubes (2)
FPM1610	Mamba 120cc Tail Wheel with Hardware
FPM1611	Mamba 120cc Main Wheel and Axle Set
FPM1612	Mamba 120cc Pushrod Linkage/Control Horn Set
FPM1613	Mamba 120cc Hardware Set
FPM1614	Mamba 120cc Premium Wing, Tail and Fin Bag Set
FPM1621	Mamba 120cc Laser Cut Wood Parts
FPM1623	32oz. (1 Liter) Fuel/Smoke Tank w/accessories
FPM1624	20mm Aluminum Engine Stand Offs (4)
FPM1626	Mamba 120cc Engine Baffle Kit

### Yellow Scheme

FPM1601	Mamba 120cc Fuselage without hatches (Yellow)
FPM1602	Mamba 120cc Top Wing Set, Left and Right (Yellow)
FPM1603	Mamba 120cc Horizontal Stabilizer and Elevator Set (Yellow)
FPM1604	Mamba 120cc Rudder (Yellow)
FPM1605	Mamba 120cc Cowling with Hardware (Yellow)
FPM1606	Mamba 120cc Canopy Hatch (Yellow)
FPM1608	Mamba 120cc Wheel Pants with Hardware (Yellow)
FPM1615	Mamba 120cc Decal Sheet (Yellow)
FPM1619	Mamba 120cc Interplane Strut Set (Yellow)
FPM1620	Mamba 120cc Top Wing Center Section (Yellow)
FPM1622	Mamba 120cc Bottom Wing Set, Left and Right (Yellow)
FPM1625	Mamba 120cc Forward Hatch (Yellow)

### Red/Blue Scheme

FPM1701	Mamba 120cc Fuselage without hatches (Red/Blue)
FPM1702	Mamba 120cc Top Wing Set, Left and Right (Red/Blue)
FPM1703	Mamba 120cc Horizontal Stabilizer and Elevator Set (Red/Blue)
FPM1704	Mamba 120cc Rudder (Red/Blue)
FPM1705	Mamba 120cc Cowling with Hardware (Red/Blue)
FPM1706	Mamba 120cc Canopy Hatch (Red/Blue)
FPM1708	Mamba 120cc Wheel Pants with Hardware (Red/Blue)
FPM1715	Mamba 120cc Decal Sheet (Red/Blue)
FPM1719	Mamba 120cc Interplane Strut Set (Red/Blue)
FPM1720	Mamba 120cc Top Wing Center Section (Red/Blue)
FPM1722	Mamba 120cc Bottom Wing Set, Left and Right (Red/Blue)
FPM1725	Mamba 120cc Forward Hatch (Red/Blue)

## LIMITED WARRANTY

### Warranty Coverage

Flex Innovations LLC and its authorized resellers (“Flex”) warrant to the original purchaser that this product (the “Product”) will be free from defects in materials and workmanship at the date of purchase.

### Outside of Coverage

The warranty is not transferable and does not cover:

- (a) Products with more than 45 days after the purchase date
- (b) Damage due to acts of God, accident, misuse, abuse, negligence, commercial use, or due to improper use, installation, operation, or maintenance
- (c) Damage to other components or assemblies associated with the use of the Product.
- (d) Modification of or to any part of the Product
- (e) Product not purchased from an authorized Flex Innovations dealer or distributor.
- (f) Product that has been partially, or fully assembled
- (g) Shipping damage
- (h) Cosmetic damage
- (i) Services or labor associated with the repair, use or assembly of the Product.

***OTHER THAN THE EXPRESS WARRANTY ABOVE, FLEX MAKES NO OTHER WARRANTY REPRESENTATION, AND HEREBY DISCLAIMS ALL IMPLIED WARRANTIES, INCLUDING, WITHOUT LIMITATION, THE IMPLIED WARRANTIES OF NONINFRINGEMENT, MERCHANTABILITY AND FITNESS FOR A PARTICULAR PURPOSE. THE PURCHASER ACKNOWLEDGES THAT THEY ALONE HAVE DETERMINED THAT THE PRODUCT WILL SUITABLY MEET THE REQUIREMENTS OF THE PURCHASER’S INTENDED USE.***

### Purchaser’s Remedy

Flex’s sole obligation and purchaser’s sole and exclusive remedy shall be that Flex will, at its option, either (i) service, (ii) replace any part of the Product determined by Flex to be defective, or (iii) replace the Product determined by Flex to be defective. Flex reserves the right to inspect all Product(s) involved in a warranty claim. Service or replacement decisions are at the sole discretion of Flex. Proof of purchase is required for all warranty claims. **SERVICE OR REPLACEMENT AS PROVIDED UNDER THIS WARRANTY IS THE PURCHASER’S SOLE AND EXCLUSIVE REMEDY.**

### Limitation of Liability

**FLEX SHALL NOT BE LIABLE FOR SPECIAL, INDIRECT, INCIDENTAL OR CONSEQUENTIAL DAMAGES, LOSS OF WAY, REGARDLESS OF WHETHER SUCH CLAIM IS BASED IN CONTRACT, WARRANTY, TORT, NEGLIGENCE, STRICT LIABILITY OR ANY OTHER THEORY OF LIABILITY, EVEN IF FLEX HAS BEEN ADVISED OF THE POSSIBILITY OF SUCH DAMAGES.**

Further, in no event shall the liability of Flex exceed the individual price of the Product on which liability is asserted. As Flex has no control over use, setup, assembly, modification or misuse, no liability shall be assumed nor accepted for any resulting damage and/or injury. By the act of use, setup or assembly, the user accepts all resulting liability. If you as the purchaser or user are not prepared to accept the liability associated with the use of the Product, purchaser is advised to return the Product immediately in new and unused condition to the place of purchase.



## **Law**

These terms are governed by Florida law (without regard to conflict of law of principals). This warranty gives you specific legal rights, and you may also have other rights which vary from state to state. FLEX RESERVES THE RIGHT TO MODIFY THIS WARRANTY AT ANY TIME WITHOUT NOTICE.

## **Questions & Assistance**

Contact Us By:

E-Mail – [support@flexinnovations.com](mailto:support@flexinnovations.com)

Phone – 1 (866) 310-3539

## **Inspection or Services**

If this Product needs to be inspected or serviced and is compliant in the region you live and use the Product in, please contact your regional Flex authorized reseller. Pack the Product securely using the original shipping carton. Please note that both the inner and outer boxes need to be included. The inner box is not designed to withstand the rigors of shipping without additional protection from the outer shipping carton. Ship via a carrier that provides tracking and insurance for lost or damaged parcels, as Flex is not responsible for merchandise until it arrives and is accepted at our facility.

## **Warranty Requirements**

For Warranty consideration, you must include your original sales receipt verifying the proof of purchase date. Provided any warranty conditions have been met, your Product or its defective parts will be replaced or serviced free of charge. Responsibility of shipping charges are as follows:

To Flex from customer, Customer is responsible.

To Customer from Flex, Flex is responsible.

Service or replacement decisions are at the sole discretion of Flex.

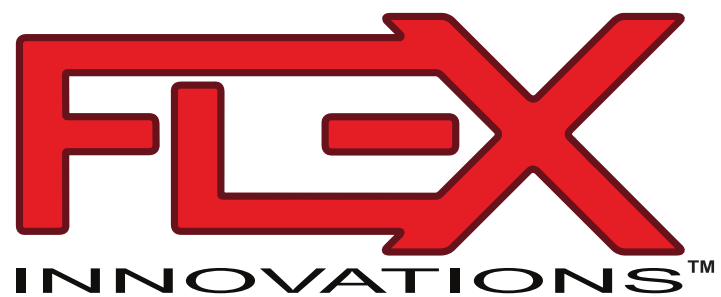

[www.flexinnovations.com](http://www.flexinnovations.com)