

注意事项 SAFETY PRECAUTIONS

- 这个产品不是玩具，而是一个复杂的具有难度的飞行器。您和您身边人的安全取决于您如何操作它，您需要了解相关知识，并谨慎操作。禁止没有成人陪伴的儿童独自操作该设备。不适合14岁以下人群使用。再次强调，这不是一个玩具。
- This product should not be considered a toy, but rather a complicated and sophisticated flying model. Your safety depends on how you use and fly it. If not correctly operated, could cause injury to you or your family members. Children must be accompanied by an adult at all times if operating this product. Not suitable for children under the age of 14. THIS IS NOT A TOY.
- 不要在机场，军事基地，居民区或其他任何受限制的地方飞行。
- Do not fly around some restricted location like airports, military bases, residential areas, etc.
- 您需要对发射机进行距离检查，以确保没有收到任何干扰。
- You will need to range check the transmitter to be sure you are not experiencing any interference.
- 始终保持先打开发射机后打开接收机，先关闭接收机后关闭发射机的步骤。
- Always turn on the receiver last after turning on the transmitter and shut off the receiver first before turning off the transmitter.
- 如果您是初学者，建议您在有经验玩家的协助下调试和飞行。
- If you are only a beginner to the radio control model flying, do not attempt to fly your model without any assistance or advice from advanced expert fliers.
- 请将相关物品放置在孩子们够不到的地方
- Keep relevant items out of reach of children.
- 这个设备的设计已经超过我们正常使用所需要刚性要求，但若您需要以超出我们推荐的动力飞行时，请合理控制动作幅度并适当增加机体强度。
- This product has been flight tested to meet or exceed our rigid performance and reliability standards in normal use, if you plan to perform any high-stress flying, you are solely responsible for taking any and all necessary steps to control movement range and reinforce the body strength.
- 您的设备中可能包括一些玻纤和碳纤维雕刻的部件，这些纤维部件所带的粉尘可能会引起眼睛，皮肤的不适，请您在需要的时候带上护目镜或者防尘服。
- This product may include some fiberglass and carbon-fiber reinforced plastic parts, which may cause eye and skin discomfort, pls wear the goggles or dust-proof clothes when needed.
- 因航空运输安全管制，您收到的产品可能没有清单中出现过的胶水，请您理解无法发送胶水给您的原因。您可以在当地文具店很方便的购买到您所需要的胶水。
- Due to air traffic safety control, the products you receive may not have the glue that appears in the list. Please understand and purchase the

飞行前的建议 PRE-FLIGHT CHECKS

- 安装舵机前，请先将舵机通电让舵机中心点回中，以便能更好的调试舵面。
- Check/adjust servo centering, in order to adjust the control surface better.
- 初次启动电机，您需要确认电机旋转的方向以适配您的机型。
- Double-check the spinning direction of motor at first usage, and sure it's suitable for your model.
- 请将重心 (CG) 调整至说明书所述位置并尽量靠近。如果有需要，您可以增加机头或者机尾的重量，以确保机体有更好的飞行姿态。
- Set the center of gravity (CG) at the position that manual already marked out. If necessary, add weight to the nose or tail to ensure the best flight performance.
- 检查机身内部，确保所有设备正常连接；检查机身表面，包括但不限于蒙皮，固定螺丝，舱盖，座舱罩等位置。
- Double-check the inside of the fuselage, make sure all the equipments are correctly connected; Check the heat-shrink covering material's surface, Make certain all screws, bolts, cabin and canopy remain secure.
- 在飞行前，请检查您电池情况，若有低电压，电池损坏等情况，请您停止操作并马上更换电池。
- Take great care when connecting/disconnecting the battery, pls replace the battery immediately once found low voltage or damage to battery.
- 机身内部设备连接的方式，会和您的收发设备有关，在一些功能更多的收发设备上，您可以通过设置简化机身内部设备的连接。详细请查看您的收发设备以确认是否满足您需要的功能。
- The way the internal devices of the fuselage are connected will be related to your transmitter-receiver device. For those transmitter-receiver devices with more functions, you can simplify the connection of the internal devices of the fuselage. Check your device for details to see if it meets the features you need.
- 动力设备和收发设备第一次配对时，可能需要设置油门最大行程，请您自行设置。
- When the power system and transmitter-receiver device are paired for the first time, you may need to set the maximum stroke of the throttle. Please set it yourself.



历史背景 Historical Background

Fi-156于1936年由Gerhard Fieseler博士设计为侦察，联络和空中救护飞机。这架飞机的起落架设计独特，从支柱和窗户处向外伸出，它的起落架垂下，看起来非常像一只长腿的大鸟，所以它被赋予了绰号“Storch”（德语中的鹤）。这是一架为短距离起飞和降落而设计建造者的飞机，在逆风时，可以在不到200英尺的高空飞行，当它以低速着陆与强逆风相结合时，Storch几乎可以垂直降落，有时看起来像向后飞。

The Fi-156 was created as a reconnaissance, liaison and air-ambulance aircraft in 1936 by Dr. Gerhard Fieseler. This unique airplane's legs, struts and windows stuck out everywhere, and its landing gear hung down, looking very much like a long-legged, big-winged bird, so it was given the nickname "Storch" (the German word for stork). Virtually nothing about a Storch is streamlined. It was a purpose-built, short takeoff and landing (STOL) aircraft which, with a bit of headwind, could become airborne in less than 200 feet, and when its low landing speed was combined with a strong headwind, the Storch appeared to land vertically, and sometimes looked like it was flying backwards.

飞行参数 Specification

翼展:1600mm (63 inch)
机长:1000mm (40 inch)
起飞重量: 1.6-1.8kg
Wingspan: 1600mm (63 inch)
Fuselage Length: 1000mm (40 inch)
Flying Weight: 1.6-1.8kg

选配配件 Optional Parts

舵机延长线15cm 6根
Y线 3根
舵机反向器 2个
Servo extension wires 15cm 6pcs
Y-wire 3pcs
Servo Reverser 2pcs

推荐配置 Suggested Equipment

推荐马达: 2814-2820 KV800-1000
推荐桨叶: 10-12寸
推荐电调: 40A
推荐舵机: 9gx8pcs
推荐电池 4S 2200-2800mAh
推荐6通道以上接收机
Suggested Motor: 2814-2820 KV800-1000
Suggested Propeller: 10-12inch
Suggested ESC: 40A
Suggested Servo: 9gx8pcs
Suggested Battery: 4S 2200-2800mAh
Radio: more than 6CH



1.6M Fieseler Fi 156 Storch Instruction Manual

散件 KIT

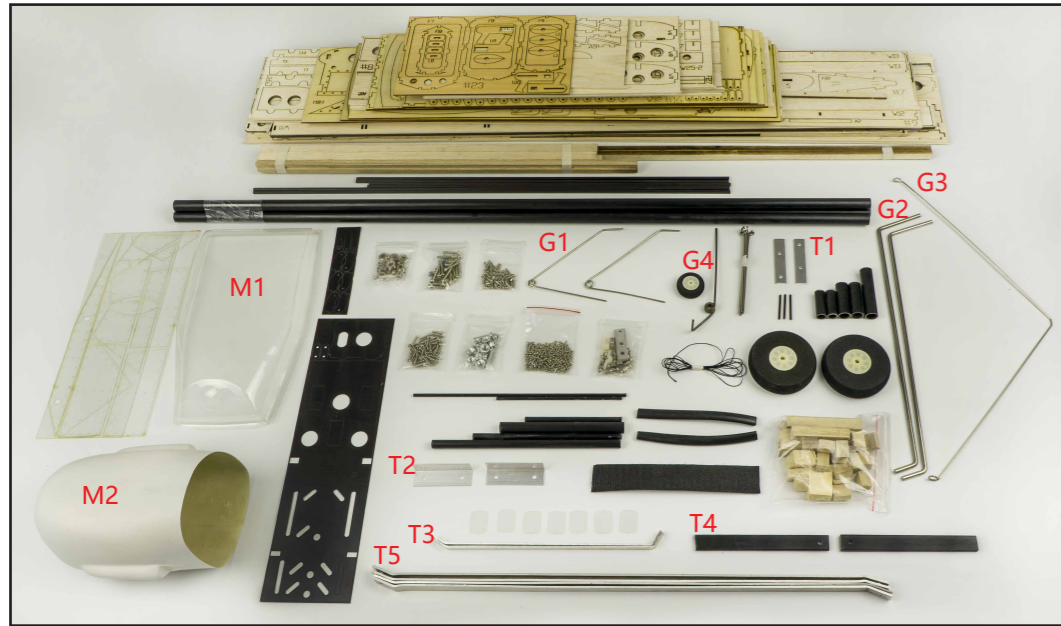

工具 Tools Needed



配件图仅供参考，您收到的实物可能因为修改/优化的原因导致与图片略有不同。
Photos shown here just for reference, the product you received maybe slightly differ from the photos due to continuous improvement on products.



01 机身组装 Assemble the Fuselage

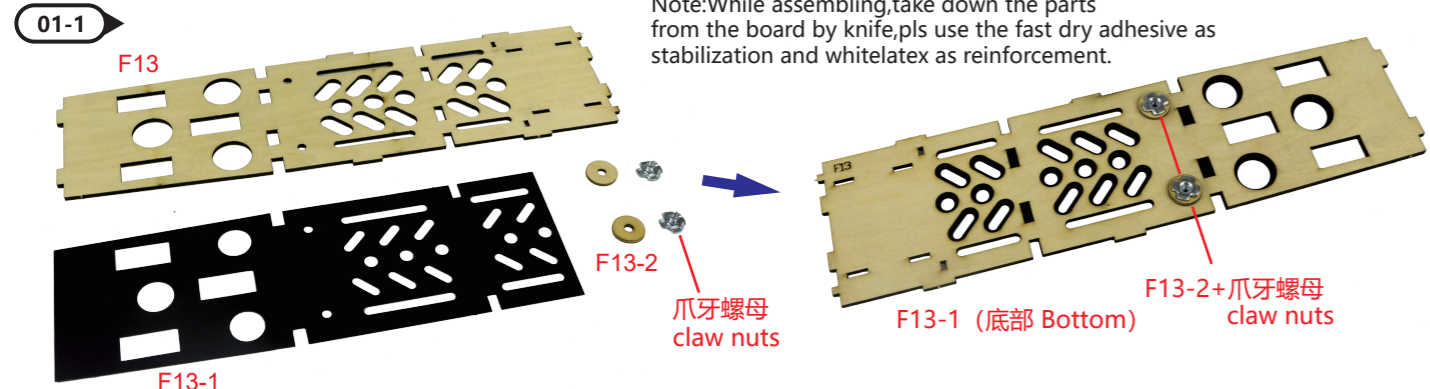

注意：进行拼装时，用美工刀从板材下取下各部件，用快干胶水定型，用白乳胶加固。
Note: While assembling, take down the parts from the board by knife, pls use the fast dry adhesive as stabilization and whitelatex as reinforcement.

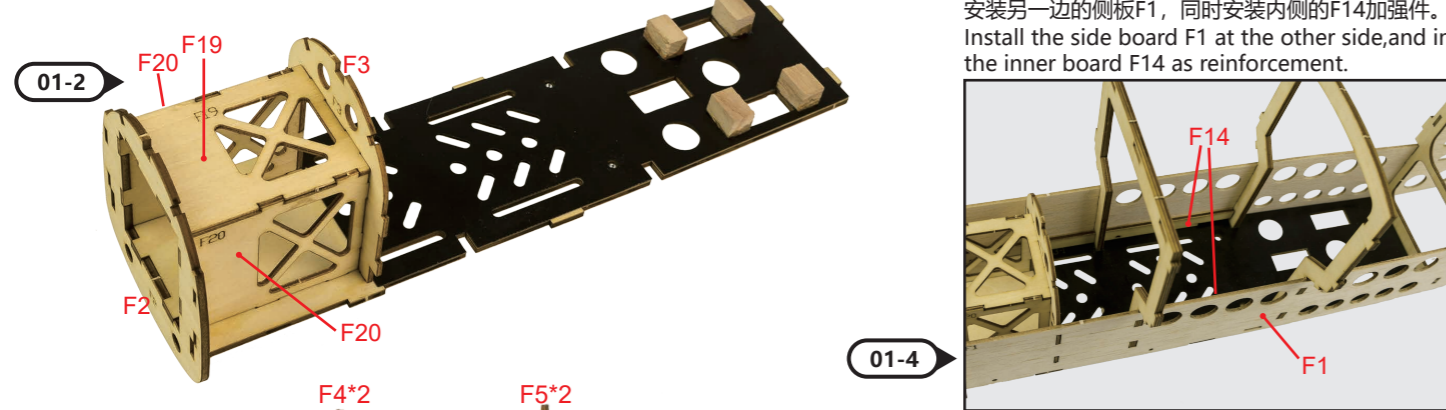

安装另一边的侧板F1，同时安装内侧的F14加强件。
Install the side board F1 at the other side, and install the inner board F14 as reinforcement.

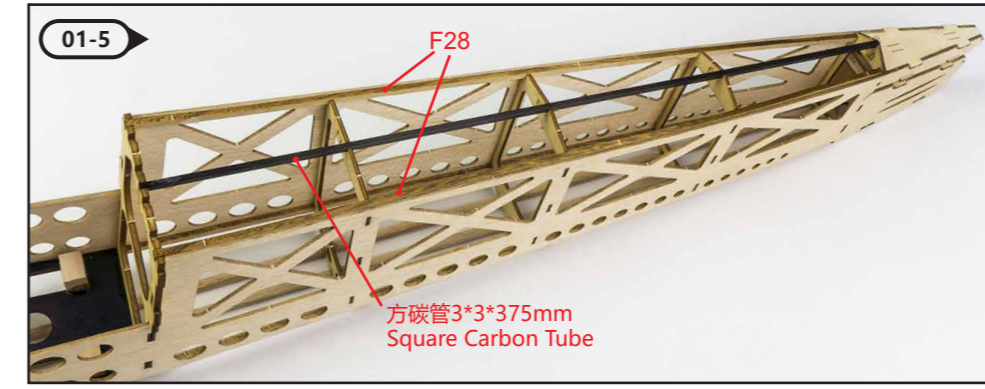
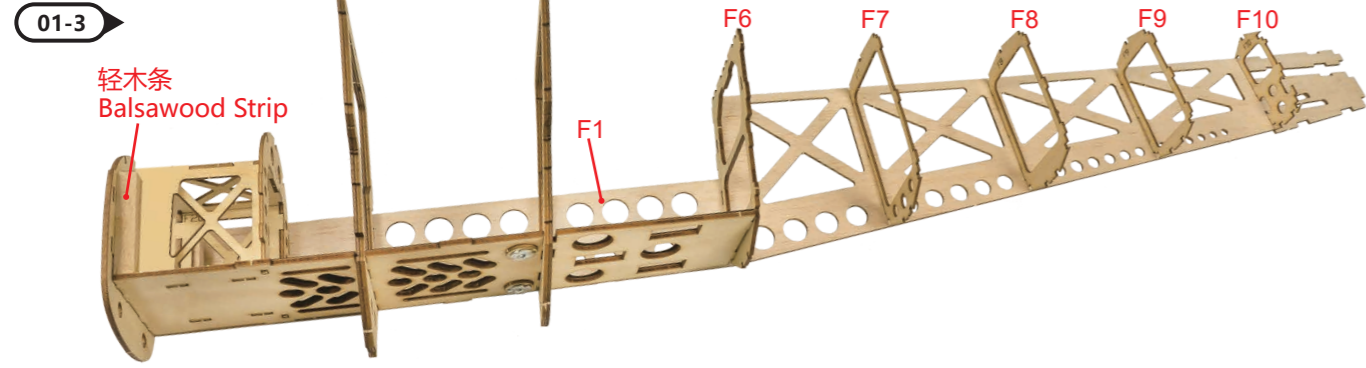

01-5

方碳管3*3*375mm
Square Carbon Tube

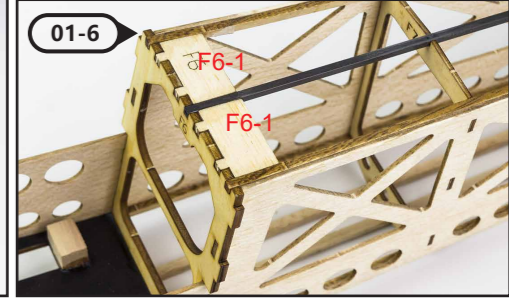

01-6



01-7

桐木条4*4*495mm
Paulownia wood Strip 4*4*495mm

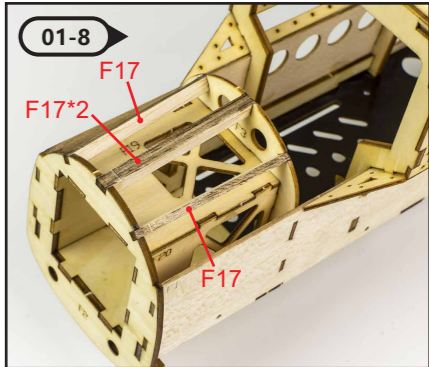

01-8

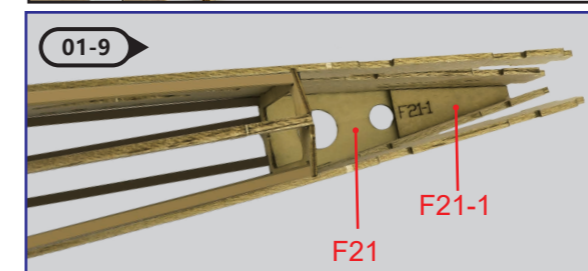

01-9

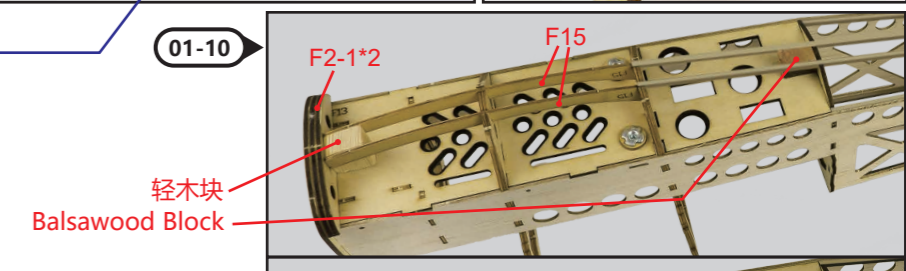

01-10

轻木块
Balsawood Block

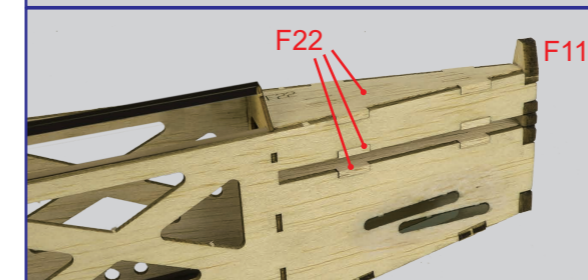

01-11

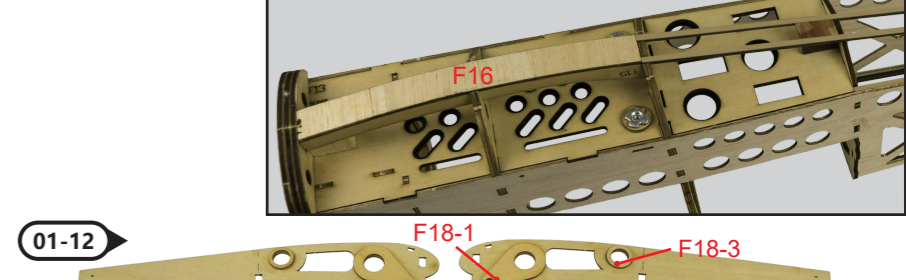

01-12

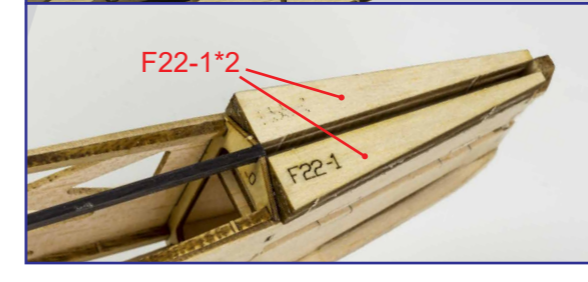

01-13

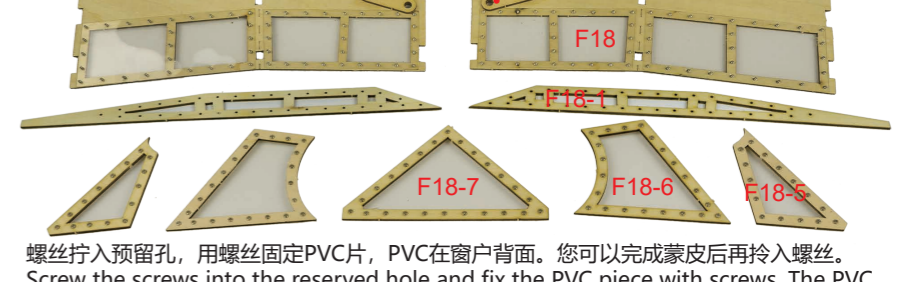

螺丝拧入预留孔，用螺丝固定PVC片，PVC在窗户背面。您可以完成蒙皮后再拧入螺丝。
Screw the screws into the reserved hole and fix the PVC piece with screws. The PVC is on the back of the window. You can cover the film and then screw in the screws.

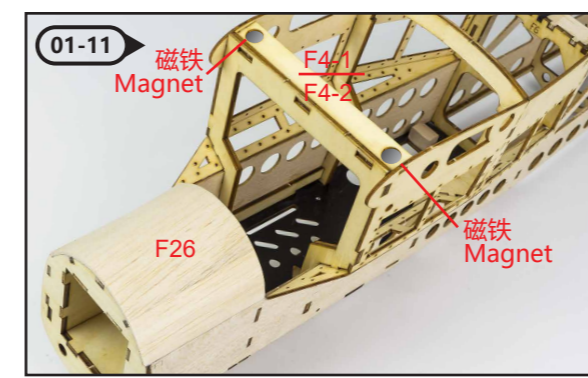

01-15

磁铁 Magnet
F4-1
F4-2
F26
磁铁 Magnet



01-16

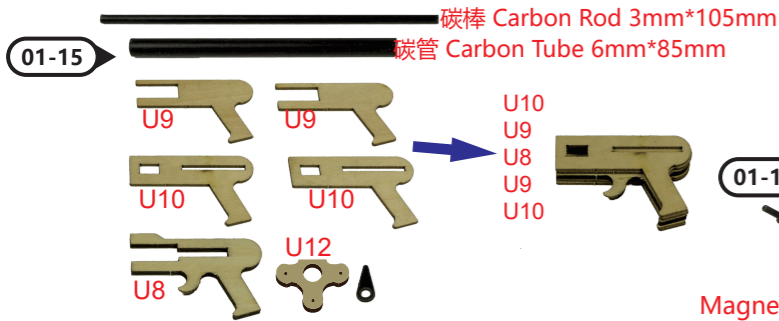
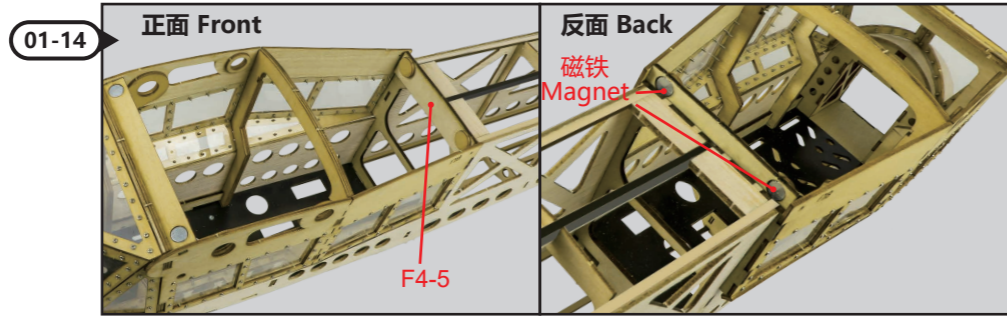
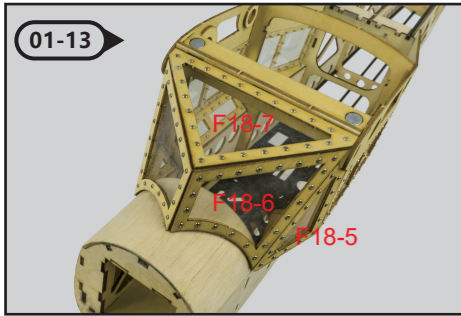

机舱罩组装根据机身形状修剪仓身罩M1
The cabin cover M1 should be trimmed and assembled as per the shape of the fuselage
修剪时需参考步骤11的描述
Refer to the description of step 11 when trimming

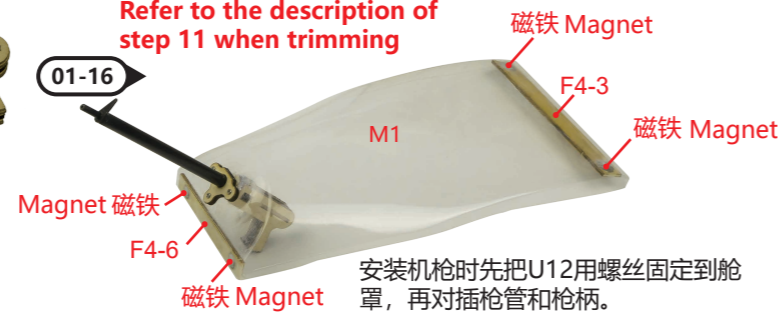

安装机枪时先把U12用螺丝固定到舱罩, 再对插枪管和枪柄。
When installing the machine gun, first fix the U12 to the cover, then insert the gun and grab the handle.

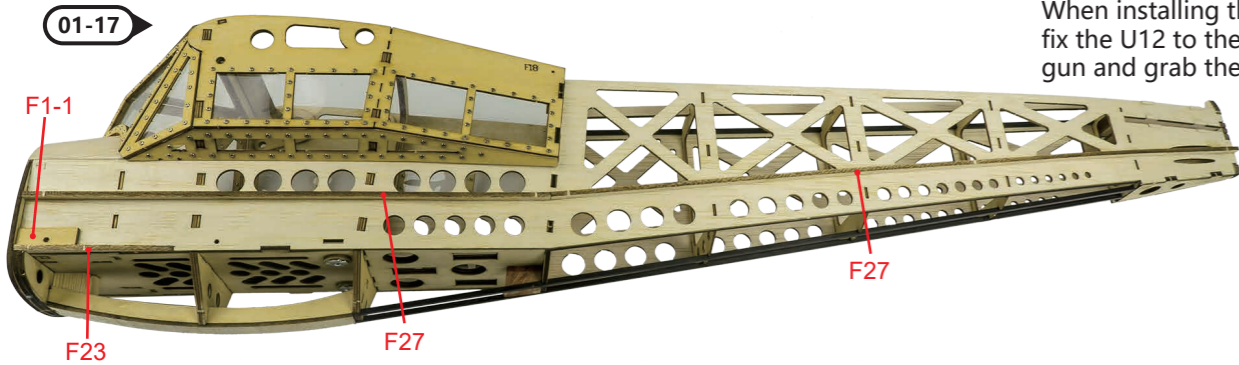

02 机翼, 尾翼组装
Assemble the Wing and Tail

机翼连接件组装 Assemble the Wing Connector

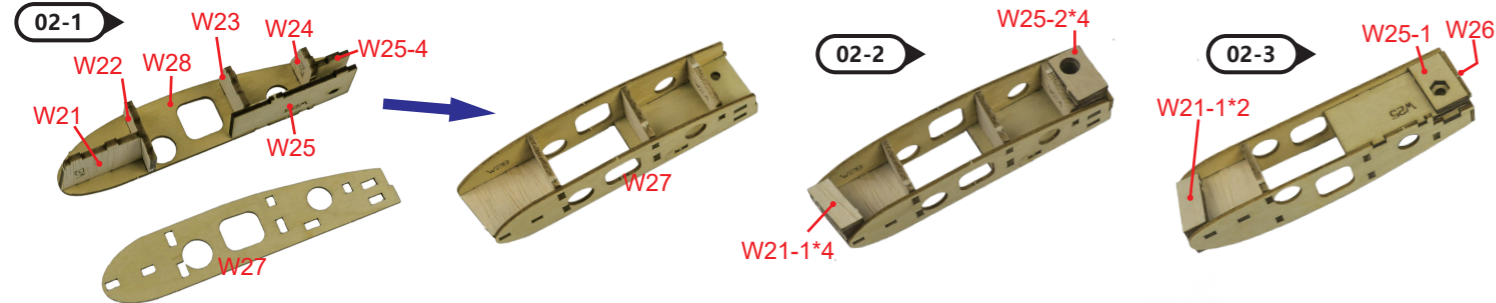

机翼连接件安装完成后, 需根据外形轮廓打磨圆滑, 参考下图示范。
After the wing connector is installed, it needs to be polished according to the contour. Refer to the following picture for reference

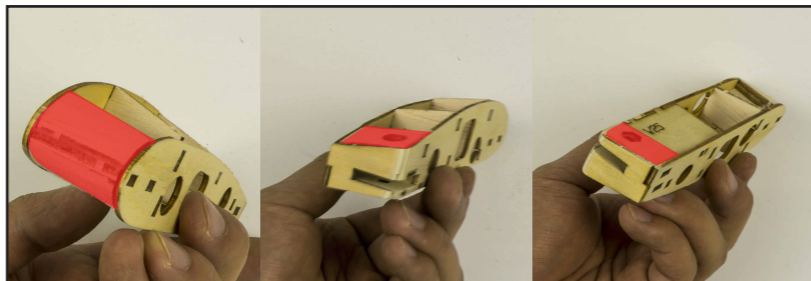
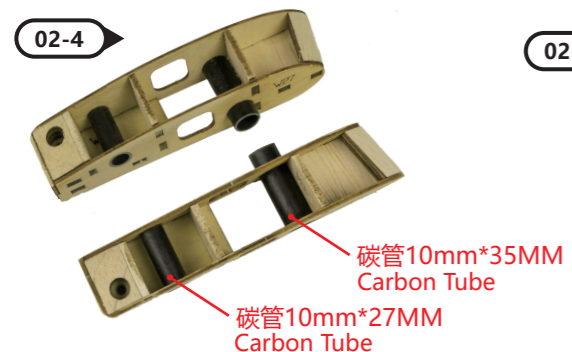

机翼组装 Assemble the Wing

02-6

机翼组装参照1: 1图纸组装, 拼装时在平面工作台进行, 并保持机翼平直。部分细节见细节图。
The wing assembly is assembled as per a 1:1 drawing, which is carried out on a flat table and keeps the wing straight. See the details for some details.

细节1
Detail 1

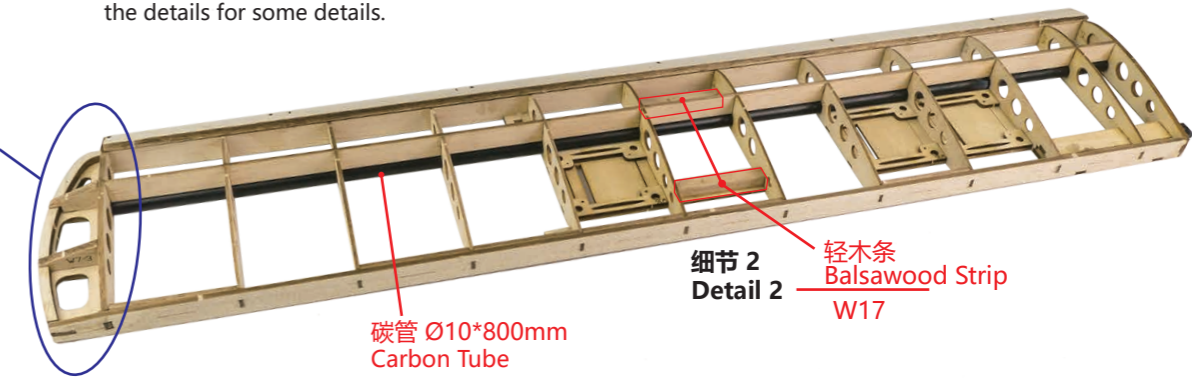
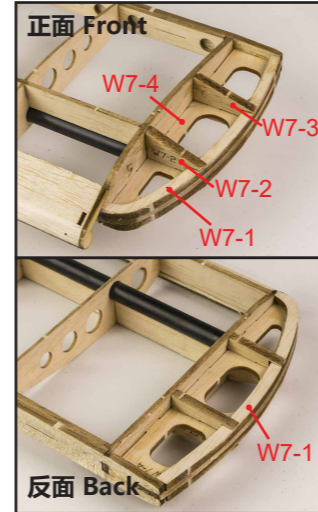

襟翼, 副翼, 可变前缘缝翼组装
Assemble the Flap, Aileron and Movable Leading Edge Slat

副翼 Aileron
02-7

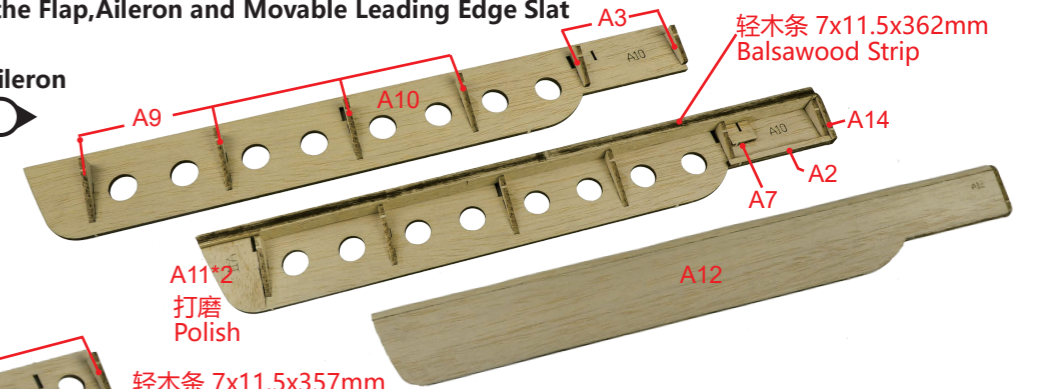

襟翼 Flap
02-8

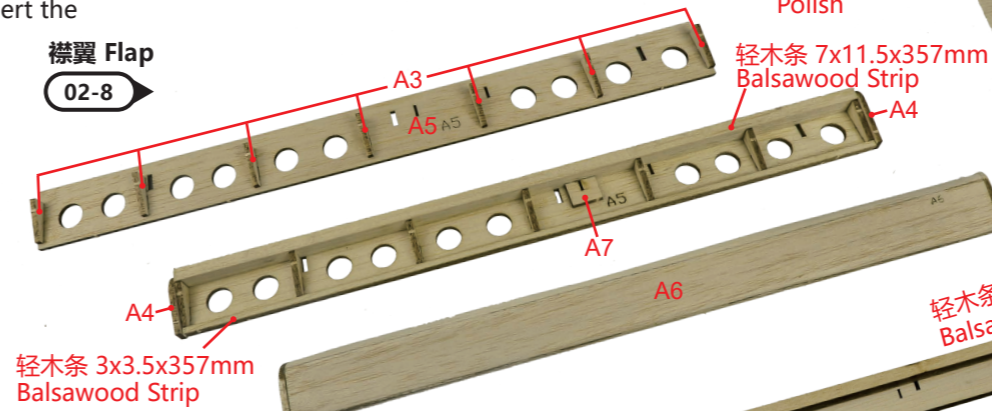

剖面图
Sectional view



剖面图
Sectional view



前缘, 副翼, 襟翼拼装完成后, 需打磨平滑, 打磨时参考剖面A15, A4形状。
After the leading edge, aileron, and flap are assembled, polishing is required. Pls refer to the section shape A15 and A4 while grinding.

可变前缘缝翼
Movable Leading Edge Slat

尾翼参照1: 1图纸进行拼装, 在拼装时使机翼平直。
The tail is assembled as per a 1:1 drawing, making the wing straight during assembly.

尾翼组装
Assemble the Tail

水平尾翼
Horizontal Tail

02-9

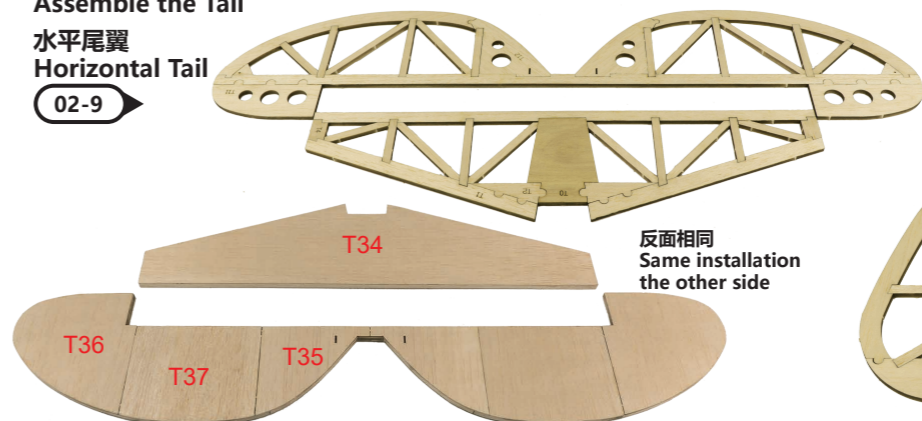

反面相同
Same installation the other side

垂直尾翼
Vertical Tail

02-10



反面相同
Same installation the other side

03 像真件组装
Assemble the scale parts

03-1 天线 Antenna
碳管 Carbon Tube 3mm*190mm
碳管 Carbon Tube 6mm*130mm
U6

03-2 驾驶座 Driver's seat
U15, U13, U14, U14, U16
橡胶套 Rubber sleeve

此部位先不粘固
Do not stick this part first

副油箱 Auxiliary tank
03-3 碳管 2mm*51mm Carbon Tube
U2, U1, 碳棒 2mm*25mm Carbon Rod

航灯 Navigation light
03-4 U4, U5
碳棒 Carbon rod 2mm*25mm

04 水平尾翼，垂直尾翼安装
Assemble the horizontal and vertical tails

04-1 切开 Cut open

04-2 安装垂直尾翼与机身保持垂直，安装水平尾翼与机身水平并居中，调整后再用胶水粘固。
The vertical tail is installed perpendicular to the fuselage, and the horizontal tail and the fuselage are horizontally centered. After adjustment, glue and fix it.

04-3 自攻螺丝 Self-tapping screws
另一边相同安装 Same installation on the other side

04-4 方向舵，和升降舵通过纸合页连接到尾翼，如图所示。安装好后使舵面可以自由摆动。
The rudder and the elevator are connected to the tail through a paper hinge as shown. After installation, the rudder surface can swing freely.

注意：若您使用电动版本 此处斜撑建议不安装。若您使用油动版本，此处斜撑建议安装
Note: If you use the electric version, it is recommended not to install the bracket. If you use the gasoline version, it is recommended to install the bracket.

支架拼装完成后，需打磨平滑，打磨时参考剖面L8形状。
After the bracket is assembled, it needs to be smoothed and polished. When grinding, refer to the section L8 shape.

T3, L9, L8, L9, L10

05 机翼安装
Assemble the Wing and Tail

05-1 碳管 15mm*110mm Carbon Tube
碳管 8mm*175mm Carbon Tube

05-2 碳管 8mm*600mm Carbon Tube

05-3 胶水粘固固定 Glue bonding
T4

05-4 反面 Back
螺丝+螺母 Screw+nut

05-5 顶面 top view
螺丝+螺母 Screw+nut

05-6 此处螺丝固定T1，螺丝拧到步骤01-1的爪牙螺母上。
Screw the T1 here and screw it onto the claw nut of step 01-1.

05-7 螺丝 Screw
螺丝 Screw

05-8 T5*2, 螺丝+螺母 Screw+nut

05-9 自攻螺丝 Self-tapping screws
此处自攻螺丝拧到步骤02-6细节2的轻木条上。
Screw the self-tapping screws onto the balsawood strip of 02-6 Detail 2.

另一边机翼相同步骤安装，安装完后机翼保持平直。
The other wing is installed in the same step, and the wing remains straight after installation.

06 起落架安装
Assemble the Landing Gear

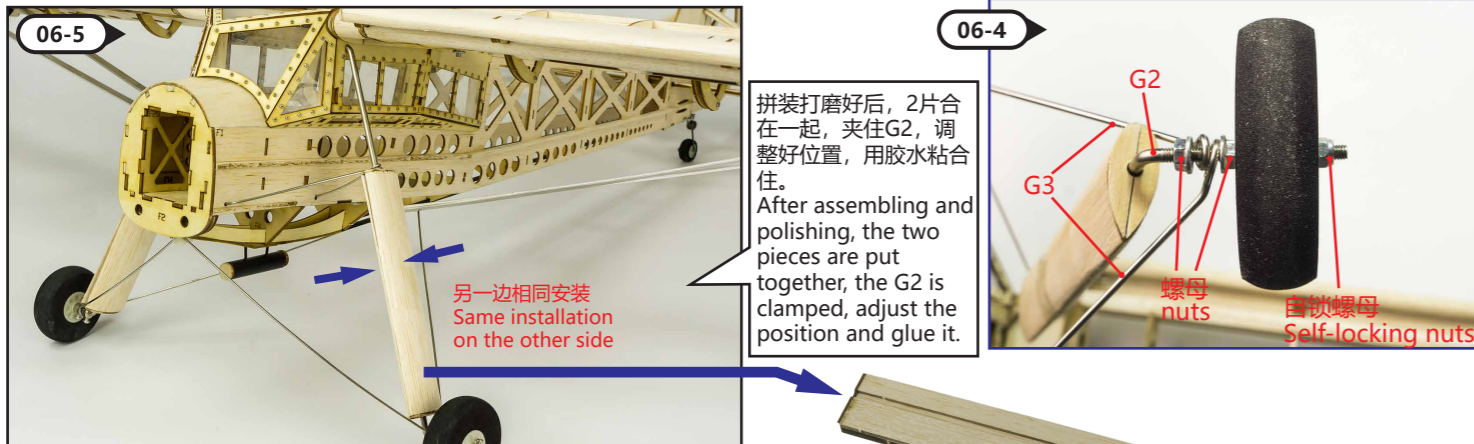
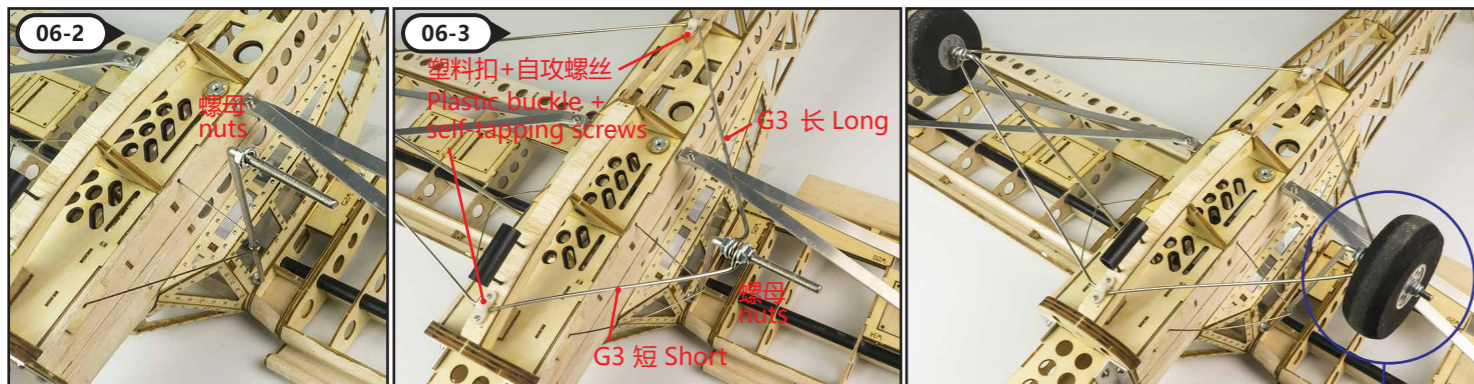
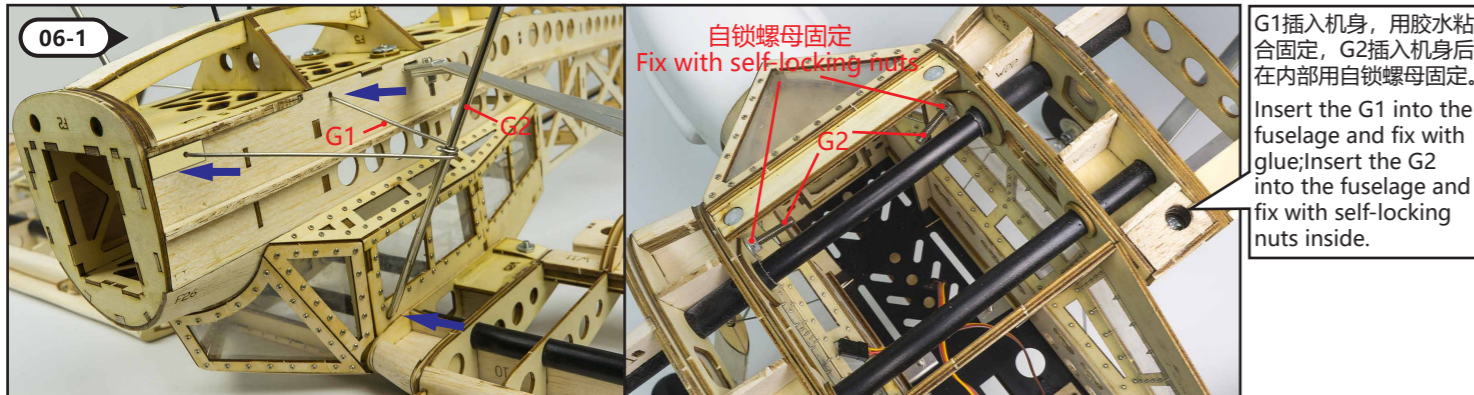

后起落架安装
Assemble the Rear Landing Gear

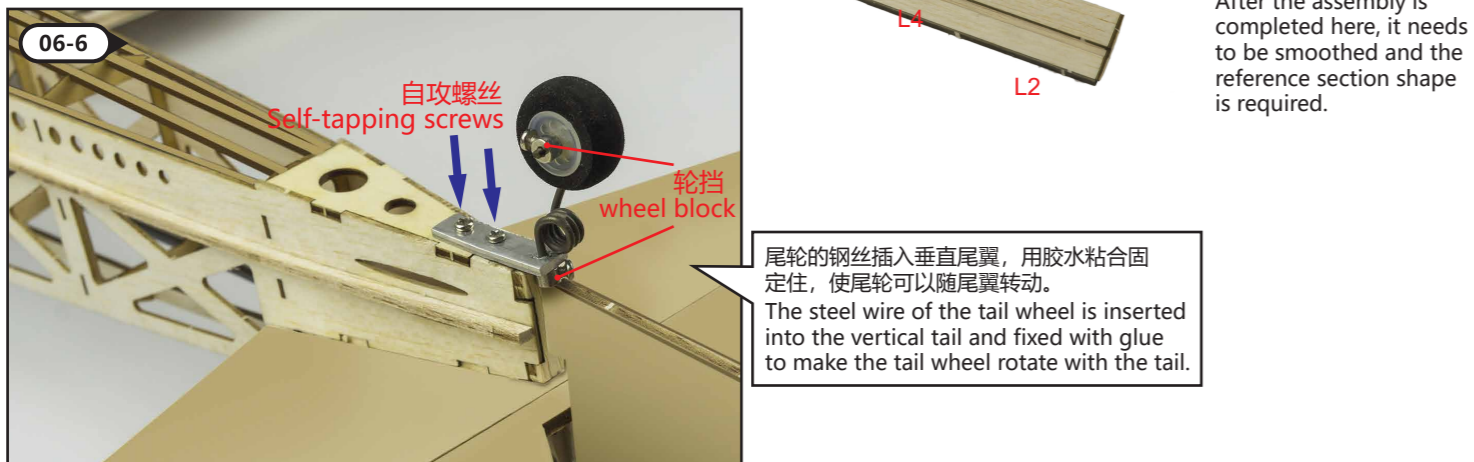

07 可变前缘，襟翼，副翼安装
Assemble the movable leading edge, flap and aileron

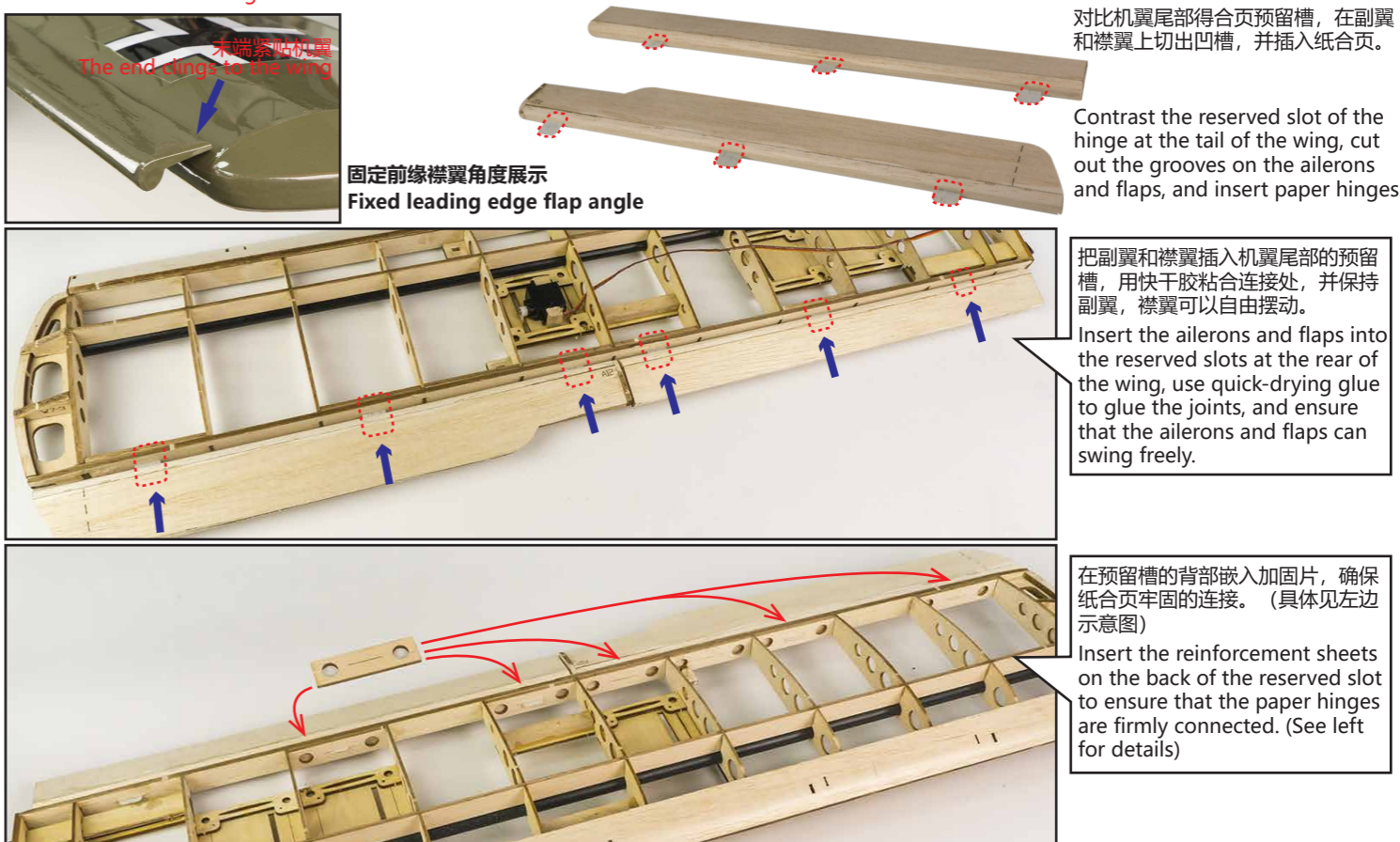

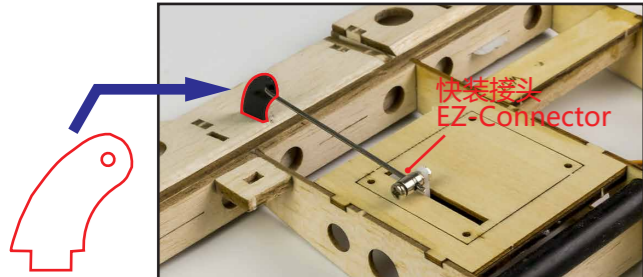

副翼连接舵机
Aileron connecting servo
襟翼连接舵机
Flap connecting servo

09 机身内舵机安装
Assemble the servo inside the fuselage

钢丝连杆穿入玻纤管，然后穿入机身，前端穿入F6-2/3固定，尾端穿入F10固定，然后从侧板预留孔穿出。
Insert the steel wire rod into the fiberglass tube, then insert into the fuselage. The front end is fixed by F6-2/3, the tail end is fixed by F10, and then the hole is pierced from the side plate.

F6-2调整到合适位置后粘贴到F6板上。
F6-2 is adjusted to the appropriate position and then pasted to the F6 board.

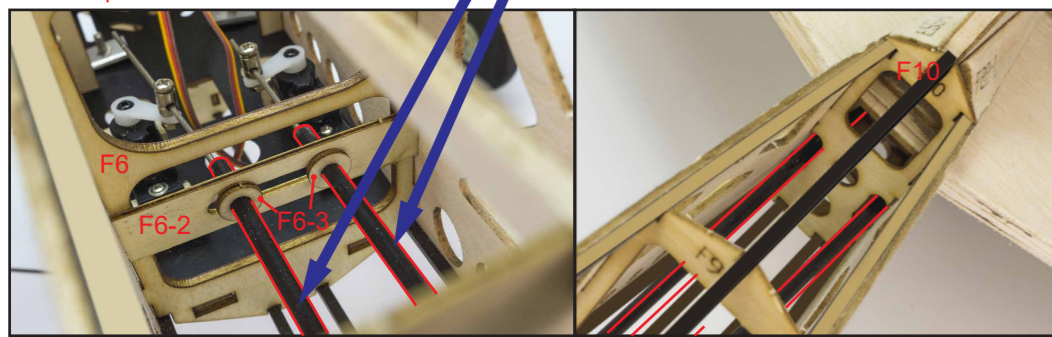

垂直尾翼连接舵机
Vertical tail connecting servo

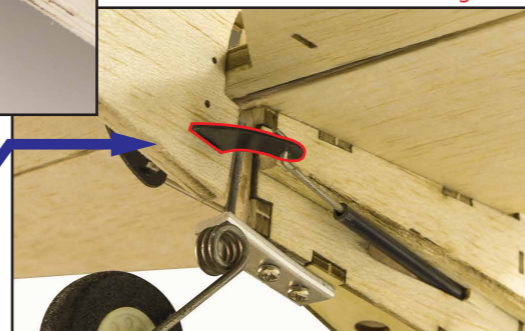

水平尾翼连接舵机
Horizontal tail connecting servo

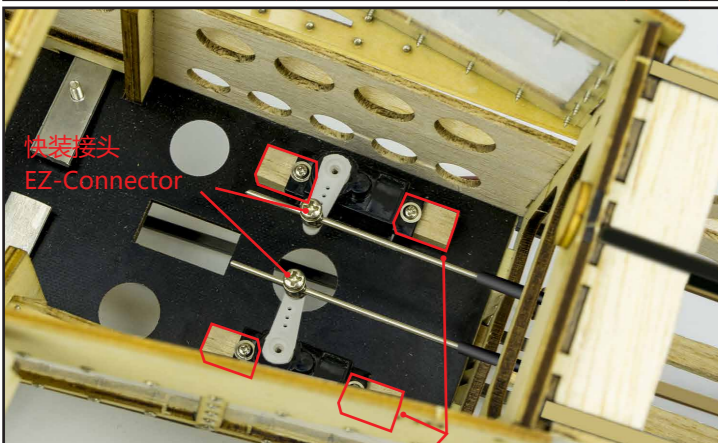
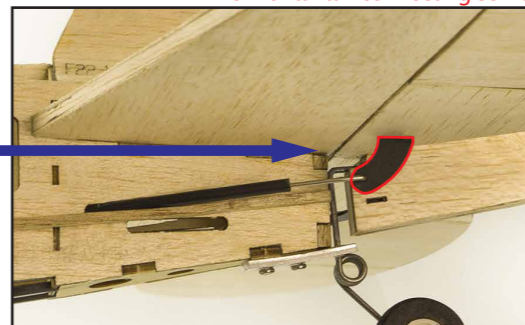

此处安装舵机需用桐木块垫起一定高度
Here the servo should be installed with a paulownia block to a certain height.

10 电机座及电机安装
Install the Motor Mounting and Motor

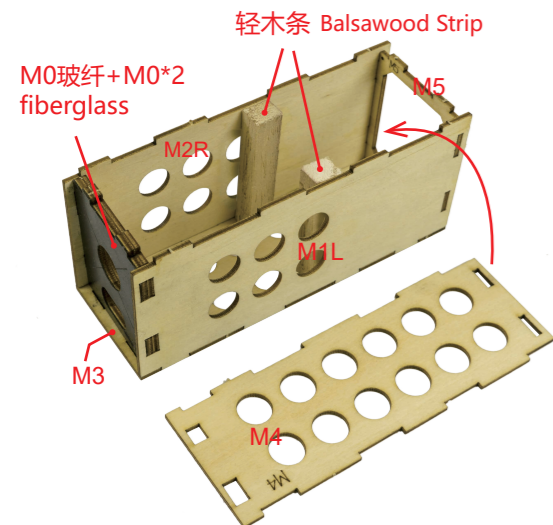

此处轻木条根据马达座与角型铝件结合的位置调整
Here the balsawood strip is adjusted according to the position of the motor mounting and the angled aluminum piece.

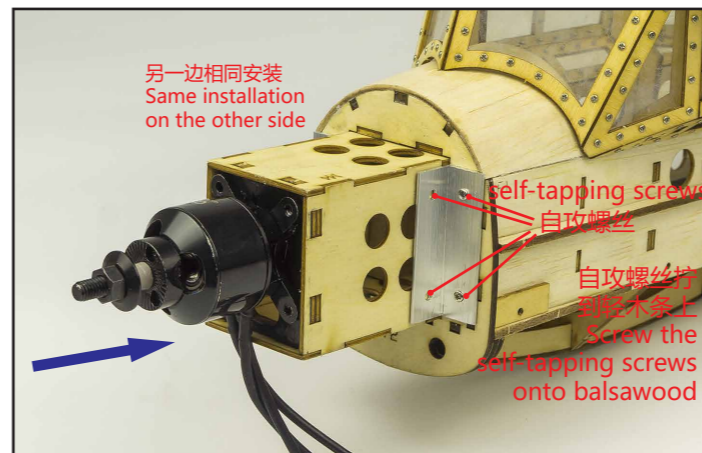

另一边相同安装
Same installation on the other side

self-tapping screws
自攻螺丝
自攻螺丝拧到轻木条上
Screw the self-tapping screws onto balsawood

电机安装示范，电机座根据所选电机调整伸出长度，调整好后再用角型铝件固定住。
Motor installation demonstration, the motor mounting adjusts the extension length according to the selected motor, and after adjustment, it is fixed by the angle aluminum piece.

此机型结构为电动马达设计，如您需要安装油动引擎，我们为您提供了2块油动引擎防火墙，安装需要一定的改装和加固，需要您自己动手修改。
This model is designed for electric motor. If you need to install the oil engine, we provide you with 2 oil engine firewalls. The installation needs certain modification and reinforcement. You need to modify it yourself.

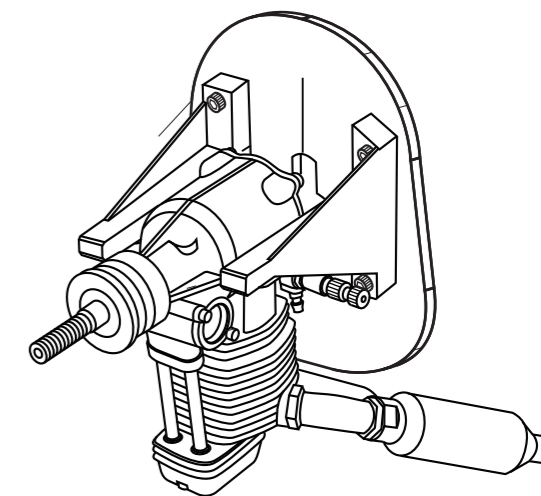
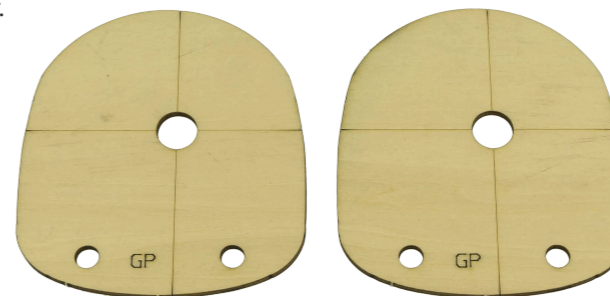

11 像真件安装
Install the scale parts

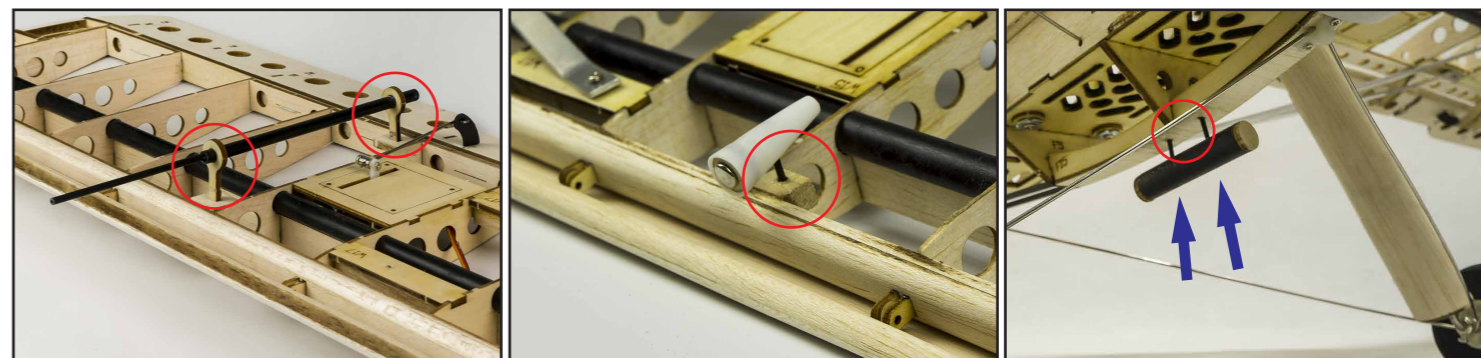

注意：您在修剪PVC舱罩时，需参考仓身前部F4-1木件的预留凹槽的孔位修剪出两个卡扣。在安装时，卡扣嵌入凹槽内。（具体见下图）
Note: When trimming the PVC hatch, you need to trim the two buckles with reference to the hole in the reserved groove of the F4-1 wooden part in the front of the cabin. While installing, the buckle fits into the groove. (See below for details)

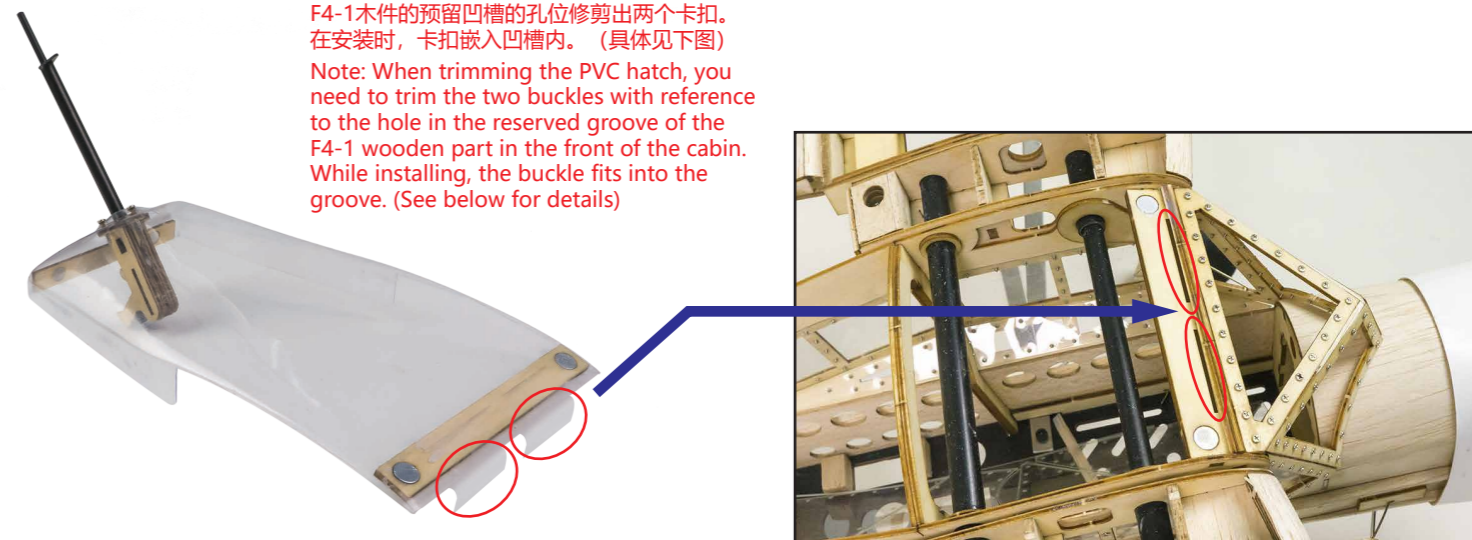

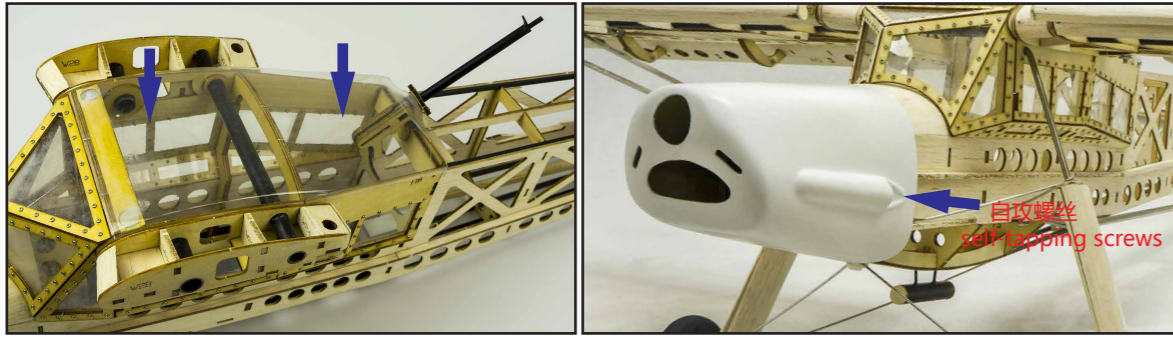

12 设置和调试
Set and Adjust

重心位置展示
Display the C.G

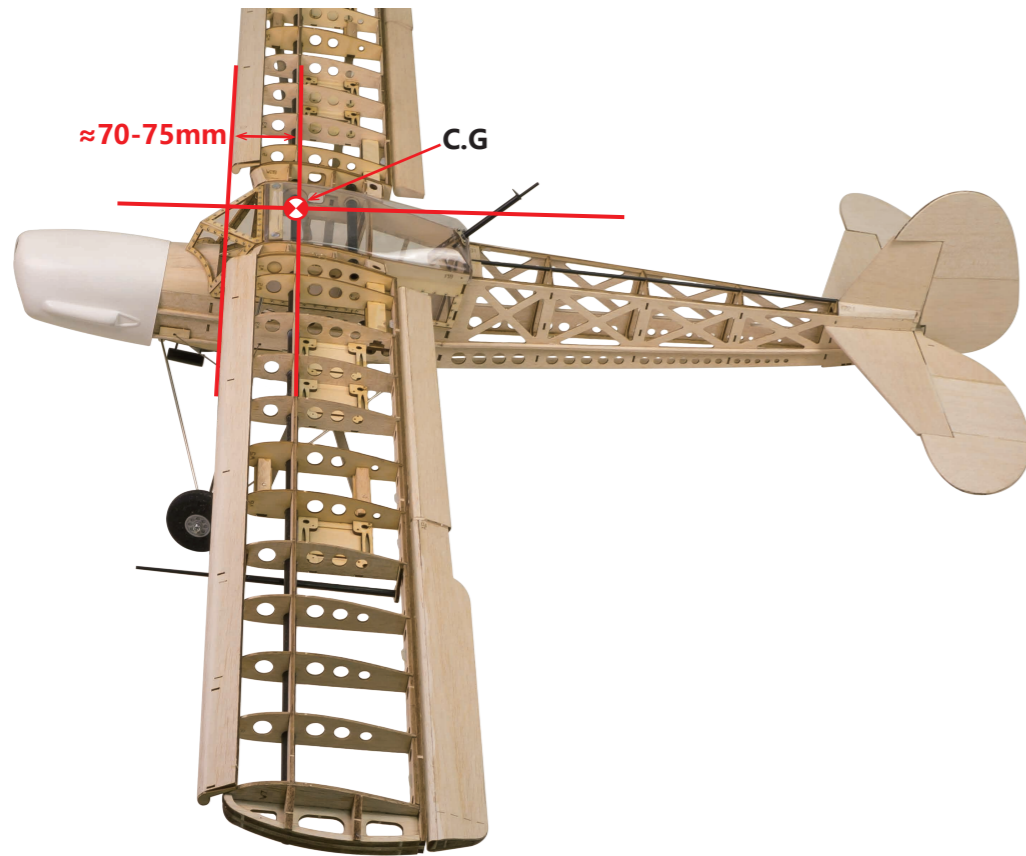

完成以上拼装后即可对飞机进行蒙皮



蒙皮详细操作可查看以下链接内容, 我们提供了蒙皮范本 (可直接扫二维码)
For detailed operation of the film, please view the following link. We provide the example (can directly scan the QR code)
<http://www.dwhobby.com/art/film>

通常情况下, 舵面角度的设置如下:
Usually, the control throws set as below:

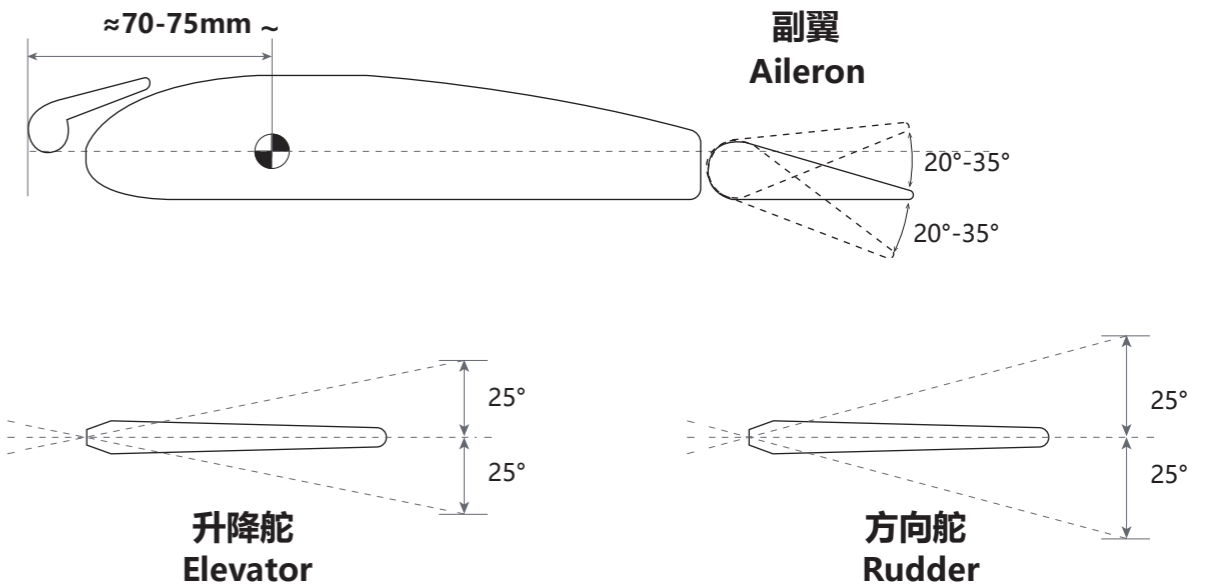

	常规飞行 (Normal Flying)	3D飞行 部分飞机支持 (3D Flying only support some models)
副翼 Aileron	± (15°-30°)	±40° 或者更大 (or larger)
平尾 Elevator	±15°	±40° 或者更大 (or larger)
垂尾 Rudder	±15°	±40° 或者更大 (or larger)
常用襟翼 Flap	(起飞 take-off) 15°-20° (降落 Landing) 20°-40°	

部分特殊机型会有V型尾翼, 襟翼, 前缘机翼或舵面很小等, 可以以常规飞行的角度作为参考, 在您不确认且没有有经验人员指导的情况下, 我们建议您先以小角度试飞以确认您的设置是否正确。
Some special models will have V-tails, flaps, leading edge wings, etc., which can be used as a reference for conventional flight angles. If you do not confirm and there is no experienced person to guide you, we recommend that you first test at a small angle to confirm that your settings are correct.

前缘缝翼
Leading Edge Slat

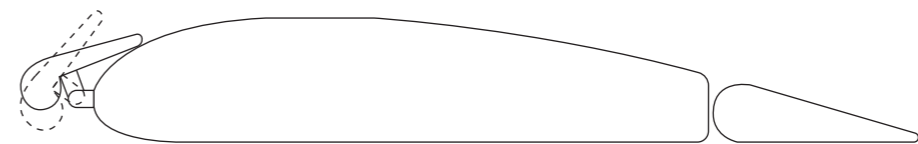

当前缘缝翼 Leading Edge Slat 紧贴机翼时 速度保持不变 升力保持不变。
当打开一定角度的前缘缝翼时, 速度减慢, 升力提升。(注意不要设置开启角度过大, 当角度太大时, 速度过慢, 升力会减小。)
When the leading edge slat is close to the wing, the speed remains the same and the lift remains the same.
When the leading edge slat is opened at a certain angle, the speed decreases and the lift increases. (Be careful not to set the opening angle too large. When the angle is too large, the speed will be too slow and the lift will decrease.)

电子设备接线图

Wiring Diagram for Electric Equipment

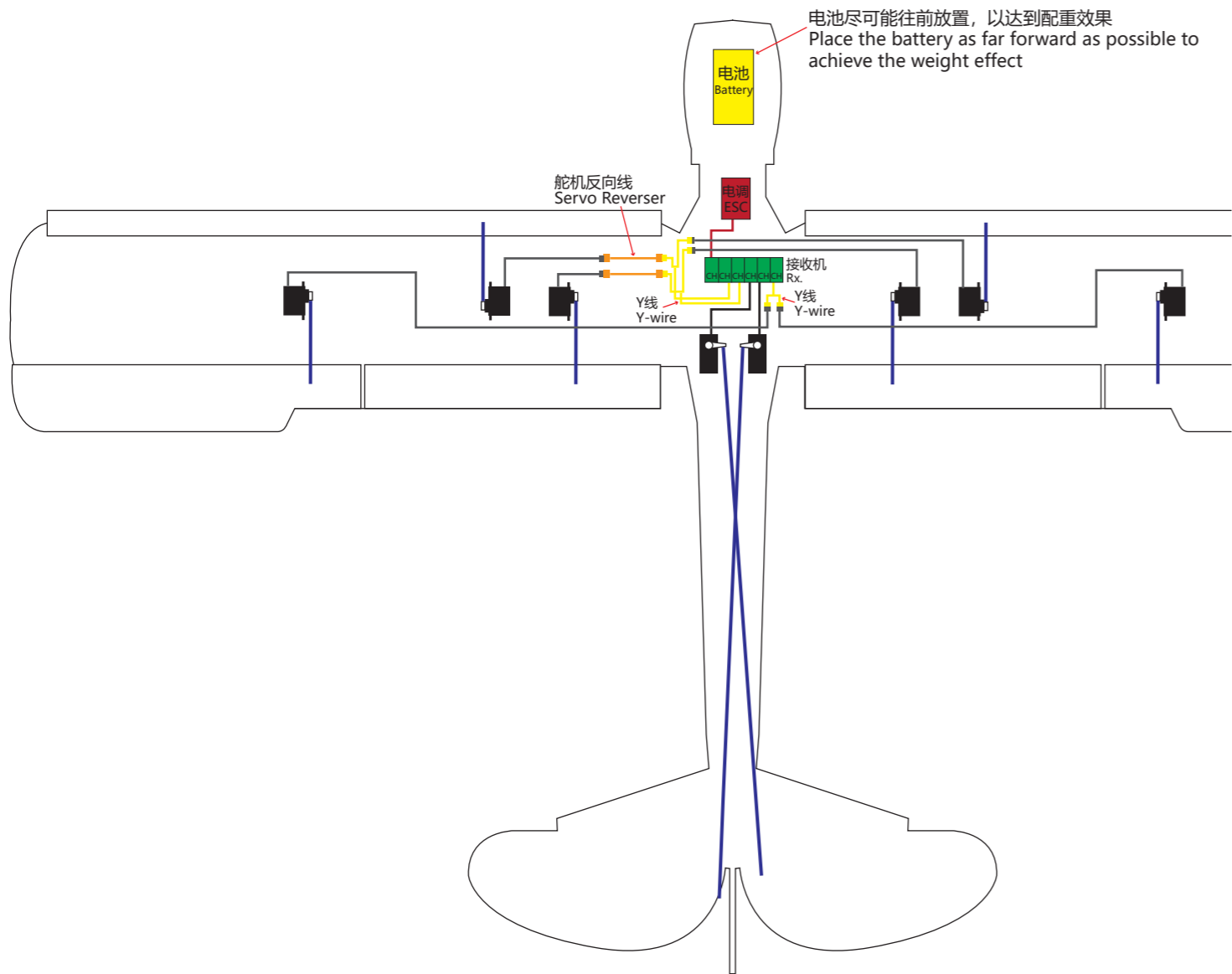

更多电子设备调试细节可参考以下链接查看 (可直接扫二维码)
More details about power system adjustment, please refer to below link: (You can scan QR Code directly.)

<http://www.dwhobby.com/art/connection>

地面控制方向测试
Control Directions Tests

	遥控器动作 Transmitter Command	飞机反应 Aircraft Reaction
升降舵 Elevator	升降杆下拉 Lifting rod down	
	升降杆上推 Lifting rod up	
副翼 Aileron	转向杆向右 Steering rod to the right	
	转向杆向左 Steering rod to the left	
方向舵 Rudder	方向杆向右 Direction rod to the right	
	方向杆向左 Direction rod to the left	