



Find out MORE



Assemble Me. Play Me

UGEAR'S®

Mechanical models

Model «Hurdy-Gurdy»
Модель «Харді Гарді»

DEU Modell «Drehleier». FRA Modèle «Vielle à roue».
POL Model «Lira korbowa». SPA Modelo «Hurdy-Gurdy».
ITA Modello «Ghironda». RUS Модель «Харди-Гарди».
JAP ハーディーガーディー KOR 허디거디.
CHI «论擦提琴»模型

Assembly instructions
Інструкція зі складання

DEU Aufbauanleitung. FRA Notice d'assemblage.
POL Instrukcja montażu. SPA Instrucciones de montaje.
ITA Istruzioni di montaggio. RUS Инструкция по сборке.
JAP 組み立て説明書 KOR 조립 설명서. CHI 装配说明书



NATURAL
Made from wood materials



NO GLUE CONNECTION
Assembling without glue
and chemicals



SELF ASSEMBLY
Details are already cut
and ready to assemble



MECHANICAL
The models produce motion



EDUCATIONAL
Perfect for early projects
through hands-on STEM learning

ENG

Manual:

Remove model parts from the hanger board as illustrated below. Careful not to break parts. If a part does not remove easily, carefully cut it out with a knife. This model is intended for self-assembly without glue. If you have difficulty installing the axles, try waxing them with a regular candle. All moving parts can also be waxed during assembly to reduce friction when operating the model.

RUS

Инструкция по сборке:

Внимайте из доски обозначенные на схеме детали. Старайтесь их не сломать. Если деталь не извлекается, надрежьте перемычки ножом. Конструкция собирается без клея. Если возникли трудности с установкой деревянной оси, перед установкой потрите детали об обычную свечу. Для лучшего скольжения смазывайте движущиеся детали механизма обычной свечой во время сборки.

UKR

Інструкція зі складання:

Витягніть з дошки позначені на схемі деталі. Намагайтеся їх не зламати. Якщо деталь не виймається, надсічіть перемички ножом. Конструкція збирається без клею. У разі виникнення труднощів з протягуванням зубочистки (вісі) в отвір потріть зубочистку об звичайну свічку. Також можна змастити свічкою всі деталі механізму, що рухаються, щоб зменшити тертя при обертанні.

JAP

組み立て説明書：

部品に傷をつけないように注意しながらボードから外してください。部品が外れにくい場合は連結部分をカッターで切ってから外すと外しやすいです。本製品は、接着剤がなくても組み立てができるように設計されています。もしアクスル(駆動部)が、歯車の動きがにぶい場合は、口ウソクをアクスルに塗ってください。全ての駆動部分は製品を動かす時、滑らかに動くように潤滑剤である口ウソクを塗りながら組み立てます。

ENG Customer support UKR Служба підтримки DEU Kundendienst FRA Service client POL Wsparcie klienta

SPA Servicio al cliente ITA Servizio di supporto RUS Служба поддержки JAP お客様窓口 KOR 고객센터 CHI 客户支持

DEU

Aufbauanleitung:

Bitte die in der Zeichnung angegebenen Teile aus der Platte herausnehmen. Versuchen Sie bitte diese nicht zu brechen. Wenn sich ein Teil nicht herausnehmen lässt, schneiden Sie die Stege mit dem Messer leicht an. Das Modell wird ohne Klebstoffe zusammengebaut. Lässt sich eine Achse nur schwer in eine Öffnung einführen, reiben Sie diese mit einer Kerze etwas ein. Für besseres Gleiten schmierien Sie alle beweglichen Teile mit einer Kerze.

KOR

조립 설명:

부품이 손상되지 않도록 주의하여 보드에서 떼어냅니다. 만약 부품이 잘 떨어지지 않으면 연결 부분을 칼로 절단 한 후 떼어내면 쉽게 떼어 낼 수 있습니다. 본 제품은 접착제가 없이 조립이 가능하도록 설계되어 있습니다. 만약 축이 잘 끼워지지 않는 경우 양초를 축에 바른 후 끼워보세요. 모든 구동 부위는 제품 구동 시 원활한 작동이 가능하도록 조립 과정에서 윤활제(양초)양초를 발라 주세요.

FRA

Notice d'assemblage:

Faites sortir de la planche les pièces comme indiquées sur le schéma. Tâchez de ne pas les casser. Si la pièce ne sort pas, incisez les collages/fixations avec un couteau. La construction est à assembler sans colle. Si il est difficile d'introduire l'axe en bois dans l'orifice, frottez au préalable l'axe ou les pièces contre une bougie. Pour améliorer le glissement, traitez les pièces de frottement mobiles du mécanisme avec une bougie au cours d'assemblage.

CHI

装配说明

将模型部件按插图示，从胶合板取下。小心不要损坏件。如果取下时候有难度，请用小刀小心的切割连接点。这个产品不需要胶水粘接。如果安装转轴的时候有难度，请用普通的蜡加以润滑。所有的转动部分也需要打蜡润滑。

POL

Instrukcja montażu:

Delikatnie wyciągaj z deseczeki wskazane w schemacie detale, starając się nie połamać elementów. Jeśli detal nie poddaje się, podetnij wiązadła nożem. Konstrukcje składa się bez kleju. Jeśli napotkasz trudności z instalacją drewnianej osi w otwór, potrzyj na początku oś lub detale o woskową świecę. Dla lepszego poślizgu polecano smarowanie ruchomych części mechanizmu zwykłą świecą podczas montażu.

SPA

Instrucciones de montaje:

Saque de la tabla las piezas marcadas en el esquema. Trate de no romperlas. Si una pieza no se saca, haga una incisión. La construcción va sin pegamento. Si tiene dificultades con la instalación del eje de madera en un agujero, frote primero el eje o las piezas contra una vela. Para un mejor deslizamiento, lubrique durante el montaje las piezas móviles del mecanismo con una vela común.

ITA

Istruzioni di montaggio:

Estrarre dal telaio i particolari indicati nello schema. Fare attenzione a non romperli. Se un particolare non si stacca, tagliare delicatamente gli elementi di collegamento con un coltello. L'assieme viene realizzato senza colla. In caso di difficoltà nell'inserimento di un perno in legno, è necessario sfregare il perno o il particolare con un po' di cera. Per uno scorrimento migliore incerare le parti mobili del meccanismo durante l'assemblaggio.

ENG Warning! UKR Увага! DEU Achtung! FRA Attention! POL Uwaga! SPA Precaución! ITA Attenzione! RUS Внимание! JAP 注意! KOR 주의! CHI 注意!



ENG Do not use a lighted candle! UKR Не підпалювати! DEU Nicht anzünden! FRA Ne pas brûler! POL Nie podpalać! SPA ¡No encender! ITA Non dare fuoco! RUS Не поджигать! JAP 火のついた口ウソクの使用はお止めください。 KOR 불이 붙은 초를 이용하지 마세요! CHI 请勿点燃，请勿靠近火源!



ENG Caution! Axles have sharp points! UKR Обережно! Гострі деталі! DEU Vorsicht! Spitze Teile! FRA Attention: certaines pièces sont pointues! POL Ostrożnie! Ostre części! SPA ¡Atención! Piezas afiladas! ITA Attenzione! Particolari appuntiti! RUS Осторожно! Острые детали! JAP アクスル(駆動部)の鋭い部分にご注意ください。 KOR 축의 뾰족한 부분에 주의하세요! 注意! CHI 舍尖锐部件!



ENG Wax the part with a regular candle (rub with a candle). UKR Змастіть деталь звичайною свічкою (потріть об свічку). DEU Reiben Sie das Teil mit einer einfachen Kerze etwas ein. FRA Lubrifiez la pièce avec une bougie ordinaire (frottez contre la bougie). POL Przesmaruj zwykłą świecą. SPA Engrase la pieza con una vela común (frote con una vela). ITA Incerare il componente (sfregare con la cera). RUS Смажьте деталь обычной свечкой (потрите о свечку). JAP 表示された部分に潤滑剤としてロウソクを塗ってください。KOR 표시된 부분에 윤활을 위해 초를 칠해 주세요. CHI 用普通蜡烛涂抹润滑部件。

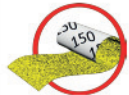
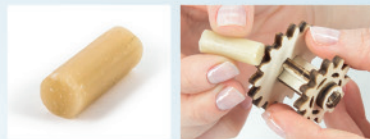

ENG Sand to remove burrs. UKR Видалить задирки. DEU Grate entfernen. FRA Éliminez les bavures. POL Usuń zadziory. SPA Quite las rebabas. ITA Togliere le bave. RUS Удалите заусенцы. JAP バリ取りのサンドペーパー KOR 거친 부분을 다듬어 주세요. CHI 磨掉毛刺



ENG Rosin. Brush over with rosin. UKR Канифоль. Натерти поверхню канифоллю. DEU Kolophonium. Mit Kolophonium einreiben. FRA Colophane. Frotter colophane. POL Kalafonia. Przetrzeć kalafonią. SPA La colofonia. Frotar con la colofonia. ITA Colofonia. Spazzolare con colofonia. RUS Канифоль. Натереть поверхность канифолью. JAP ロジン ロジンで掃除してください。KOR 송진가루. 송진가루를 칠할 것. CHI 松香 刷过松香

ENG Do not fully press the outer parts (structural frame) together until checking for fit and alignment of internal parts. UKR Деякий час не притискайте сильно деталі (рамки конструкції). DEU Drücken Sie die Teile (die Rahmen der Konstruktion) momentan nicht stark. FRA Ne pas forcer sur les pièces (cadre de la construction). POL Tymczasowo nie dociskaj elementów (ramy konstrukcji). SPA No presione temporalmente con fuerza las piezas (marco de la estructura). ITA Non stringere provvisoriamente i componenti con forza (base della costruzione). RUS Временно сильно не прижимайте детали (рамки конструкции). JAP 内部部品がしっかりと組み立てられる前に外部部品は強く押しながら固定してはいけません。KOR 아직은 외부의 틀을 완전히 눌러서 고정하면 안됩니다. 다른 부품을 먼저 끼우세요. CHI 在检查内部零件的配合和对准之前, 请暂时不要将外部零件 (结构框架) 完全压在一起。



ENG Press the parts as far as they will go. UKR Притисніть деталі до упору. DEU Drücken Sie die Teile bis zum Anschlag. FRA Poussez les pièces à fond. POL Przyciśnij element, aż do oporu. SPA Pulse para detener las piezas. ITA Stingere bene i componenti. RUS Прижмите детали до упора. JAP 部品をできる限り押してください。KOR 부품을 양쪽에서 눌러서 고정해 주세요. CHI 用力紧密结合部件



ENG Pay attention. Check for correct orientation or positioning. UKR Зверніть увагу. Перевірте розташування елемента. DEU Bitte Beachten. Prüfen Sie die Einbaulage des Elementes. FRA Faites attention. Vérifiez la disposition de l'élément. POL Zwróć uwagę. Sprawdź lokalizację elementu. SPA Atención. Compruebe la situación del elemento. ITA Prestare attenzione. Controllare la posizione del componente. RUS Обратите внимание. Проверьте расположение элемента. JAP 方向及び位置に注意して組み立ててください。KOR 방향 또는 위치에 주의해서 조립해 주세요. CHI 注意! 检查部件方向和位置



ENG Cut crosspieces before removing the part from the board. UKR Обріжте перемички перед витяганням деталі. DEU Schneiden Sie die Stege ein, bevor Sie das Teil rausnehmen. FRA Découpez les fixations avant de retirer les pièces. POL Obetnij uszczelnienia przed wyciągnięciem elementu. SPA Corte los puentes antes de extraer la pieza. ITA Tagliare gli elementi di collegamento prima di estrarre i particolari. RUS Обрежьте перемычки перед выниманием детали. JAP 部品を外す前に連結部分を切ってください。KOR 부품을 떼어내기 전, 연결 부분을 잘라 주세요. CHI 在取下部件前切断连接点

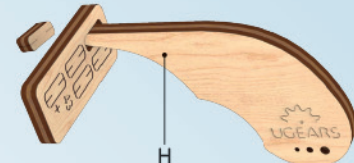

ENG This is not a structural component; it is a tool for measurement and assembly. UKR Це не деталь конструкції, а допоміжний інструмент для складання або вимірювання відстаней. DEU Es ist kein Teil der Konstruktion, sondern ein Hilfselement für den Zusammenbau oder für das Messen der Abstände. FRA Cette pièce ne fait pas partie de la construction mais constitue un outil annexe pour l'assemblage ou la mesure des distances. POL To nie detal konstrukcji, a pomocnicze narzędzie dla montażu i wymiaru odległości. SPA No es una pieza de la construcción sino un instrumento auxiliar para montar o para medir distancias. ITA Non è un componente del modello, ma un'attrezzatura aggiuntiva per il montaggio o il rilievo delle quote. RUS Это не деталь конструкции, а вспомогательный инструмент для сборки или измерения расстояний. JAP この部品は完成時の部品ではなく、組み立てをサポートしたり測定する道具です。KOR 이 부품은 조립을 위한 부품이 아니고 조립을 돕거나 측정을 위한 도구입니다. CHI 这不是装配零部件, 是一种测量及安装辅助工具。



ENG The part should be easily rotated (moved). UKR Деталь повинна легко крутитися (рухатися). DEU Der Teil soll leicht gedreht (bewegt) werden. FRA La pièce doit tourner (se déplacer) aisément. POL Element powinien łatwo się kręcić (poruszać się). SPA La pieza debe ser fácil de girar (mover). ITA Il componente deve girare (muoversi) facilmente. RUS Деталь должна легко крутиться (двигаться). JAP 部品はしっかりと動かなければなりません。KOR 활하게 움직일 수 있어야 합니다. CHI 此部件应灵活转动



ENG Auxiliary model "hammer". Use for rigid connections. UKR Допоміжна модель "Молоток". Застосовувати для жорстких з'єднань. DEU Hilfsmittel Multitool "Zange". Für eine starre Verbindung verwenden. FRA Pièce-outil "marteau". À utiliser sur les joints. POL Model pomocniczy "młoteczek". Dla sztywnych połączeń. SPA Modelo auxiliar "martillo". Aplicar para las conexiones rígidas. ITA Modello ausiliario "martello". Da utilizzare per connessioni rigide. RUS Вспомогательная модель "Молоток". Использовать для жестких соединений. JAP 補助ツール「ハンマー」。固い連結部にお使いください。KOR 부가 모델 '해머'. 견고한 결합을 위해 사용. CHI 辅助性模型"木槌"使用刚性连接



① ⑥

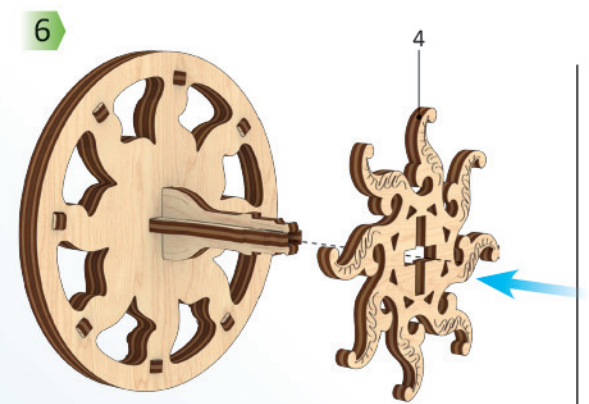
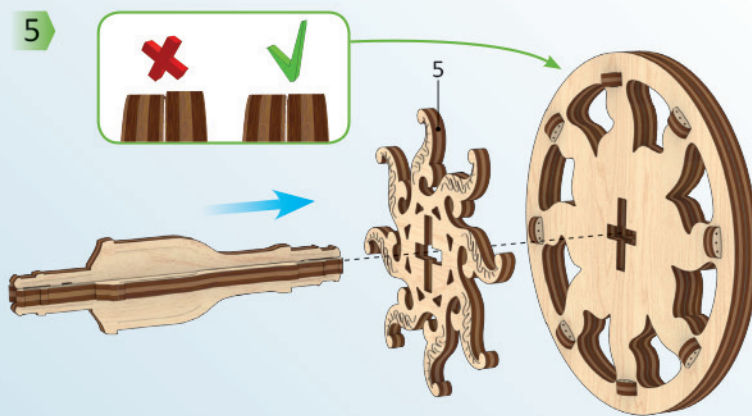
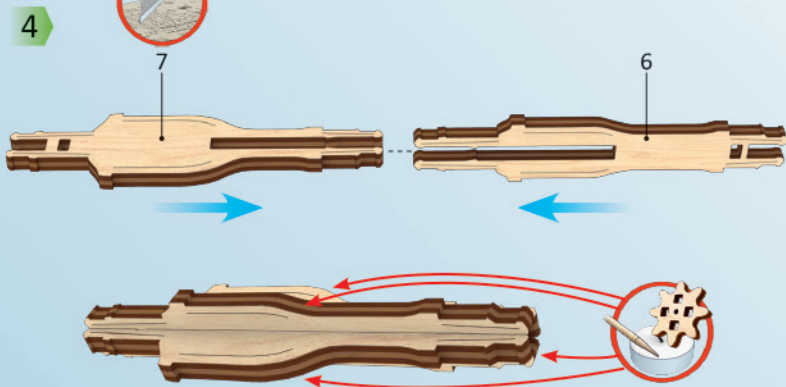
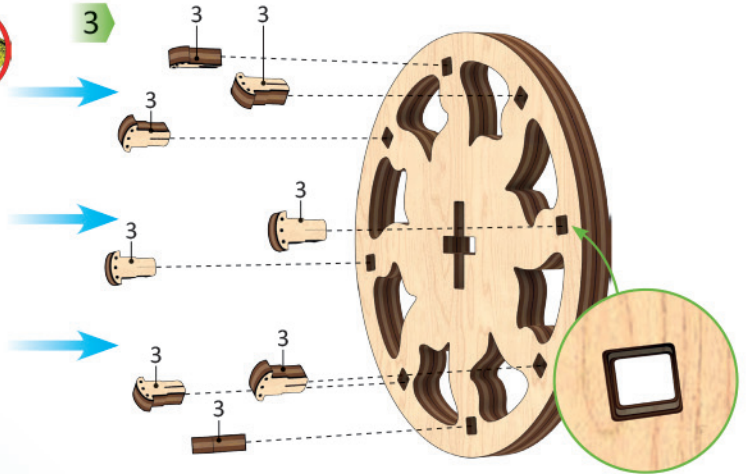
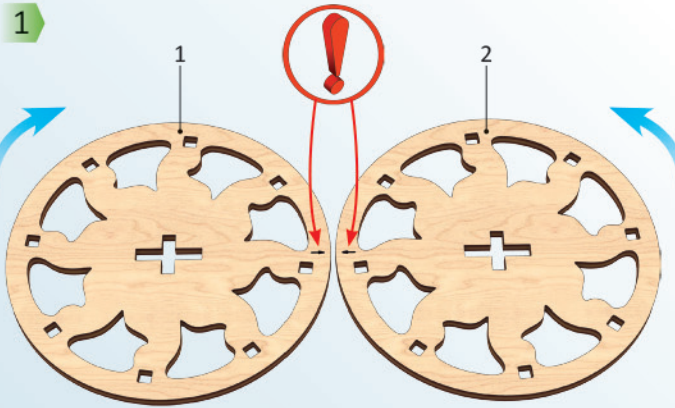



1

3

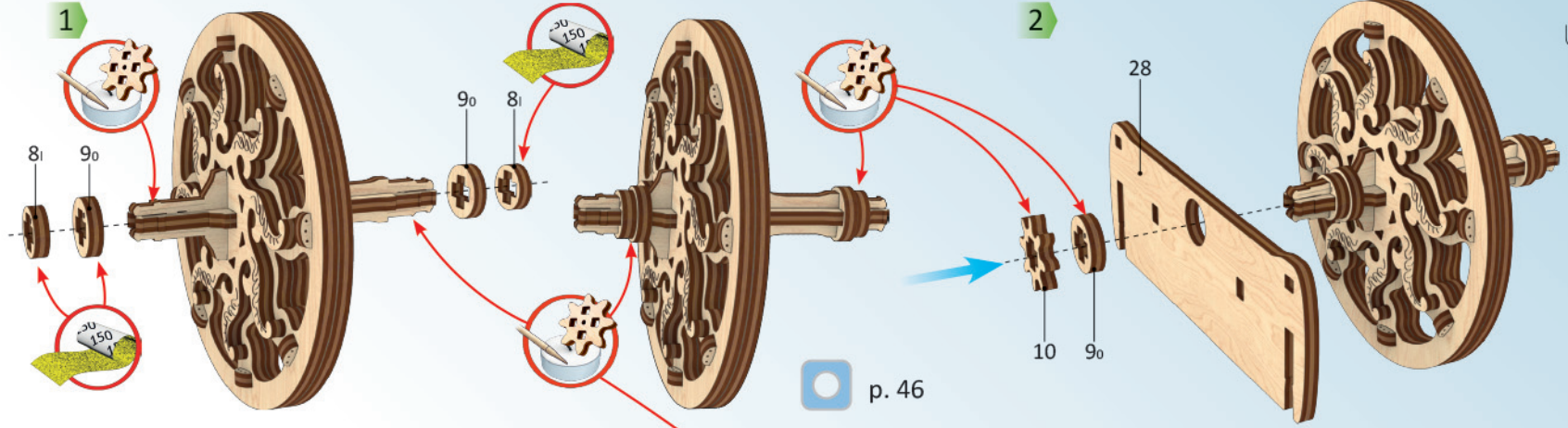

3

4

5

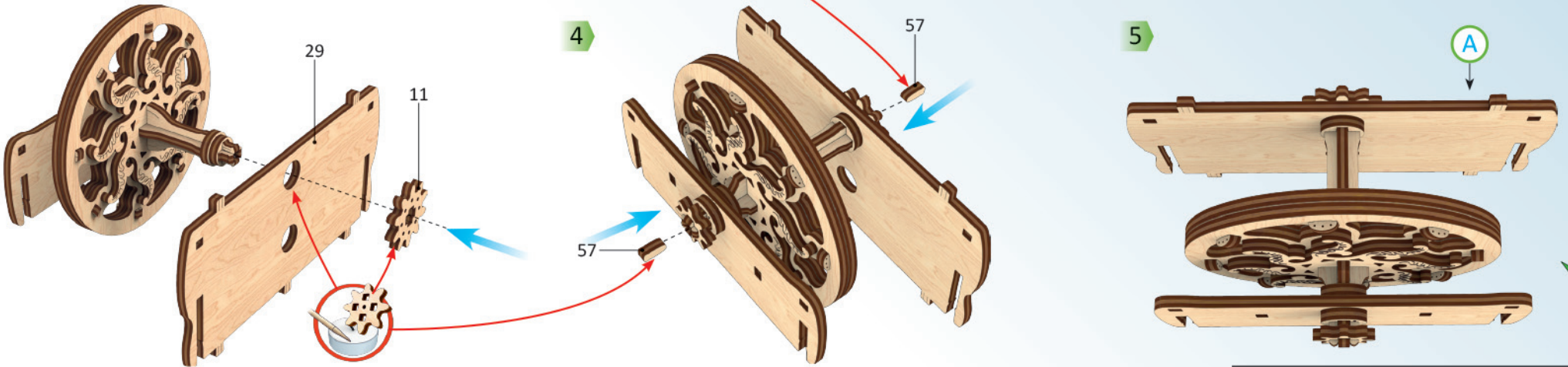

5

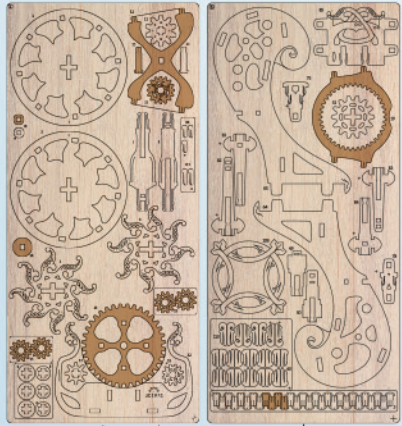

① ⑥

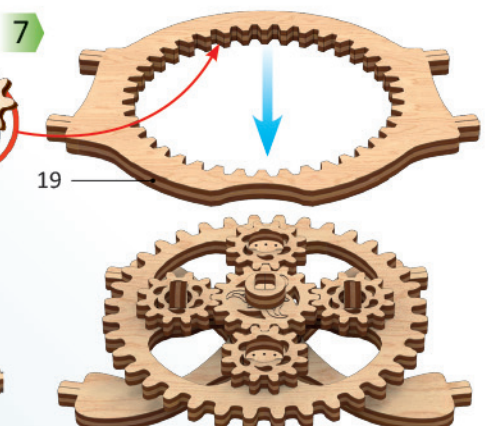
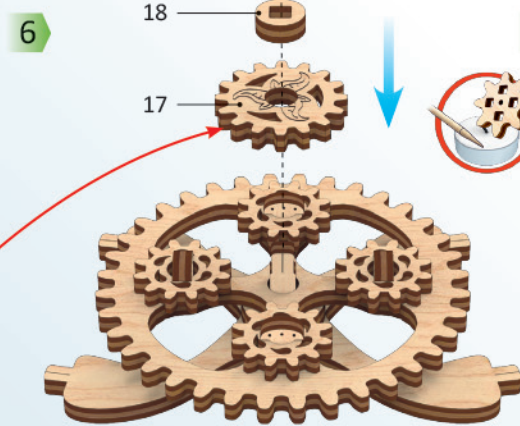
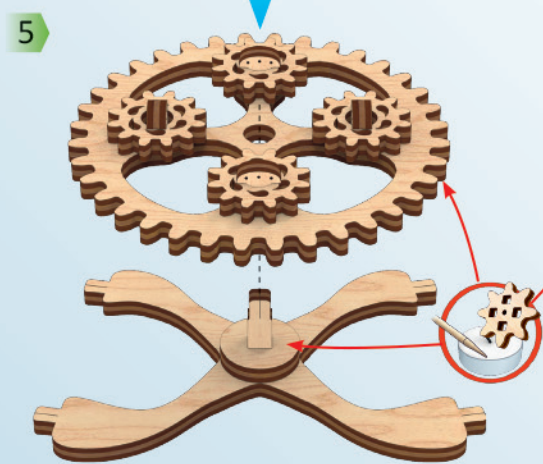
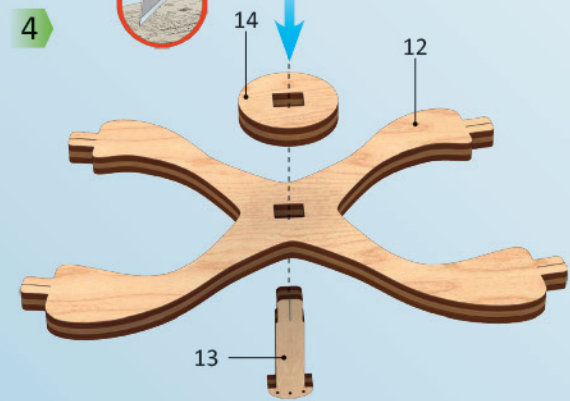
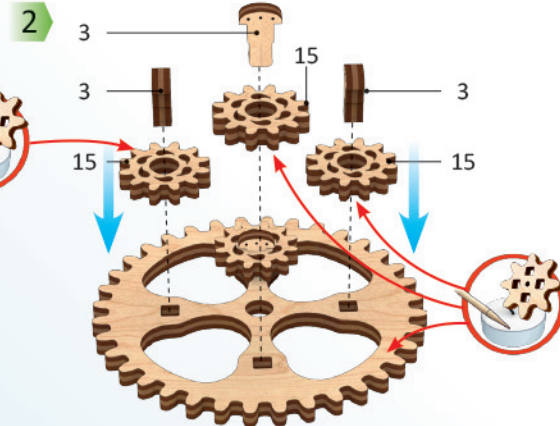
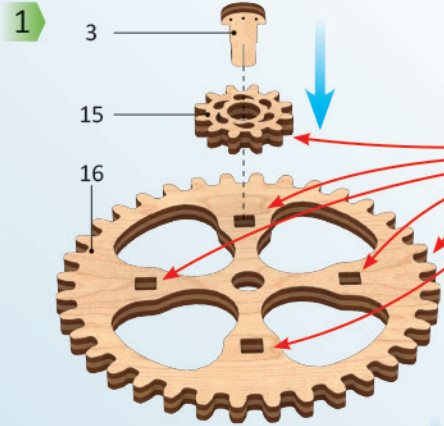

⑥

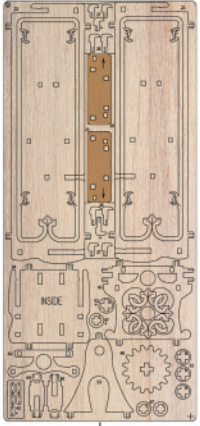

1

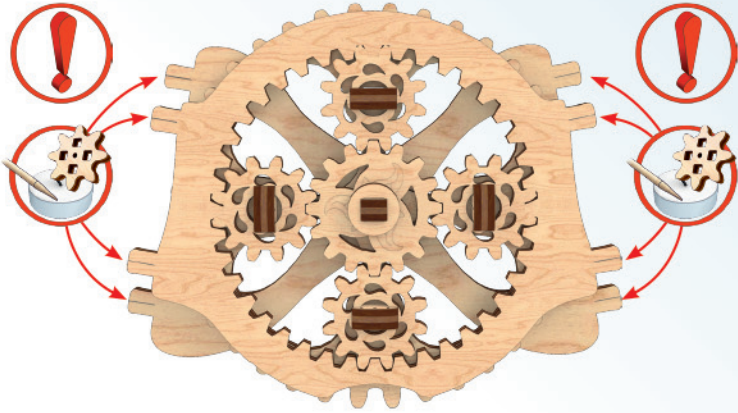

2

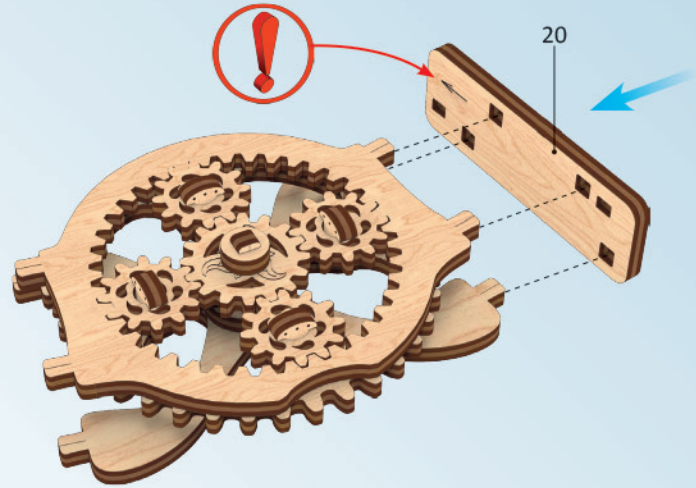

3

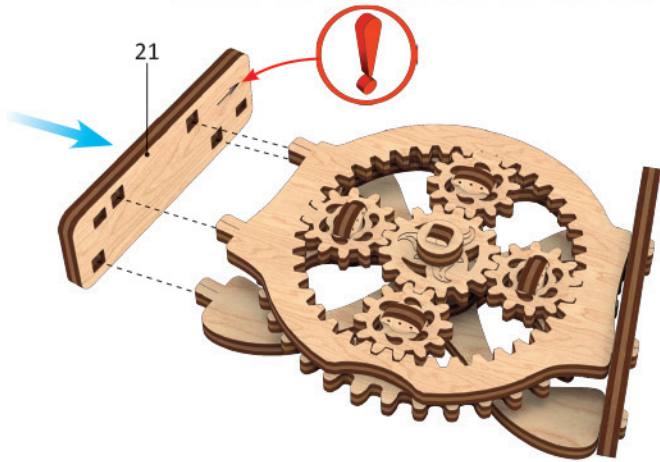

4

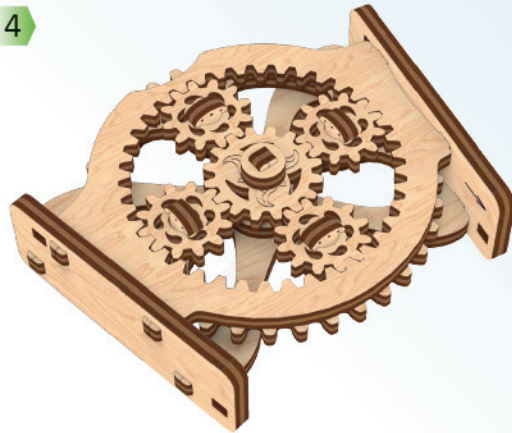

7

Mechanical models

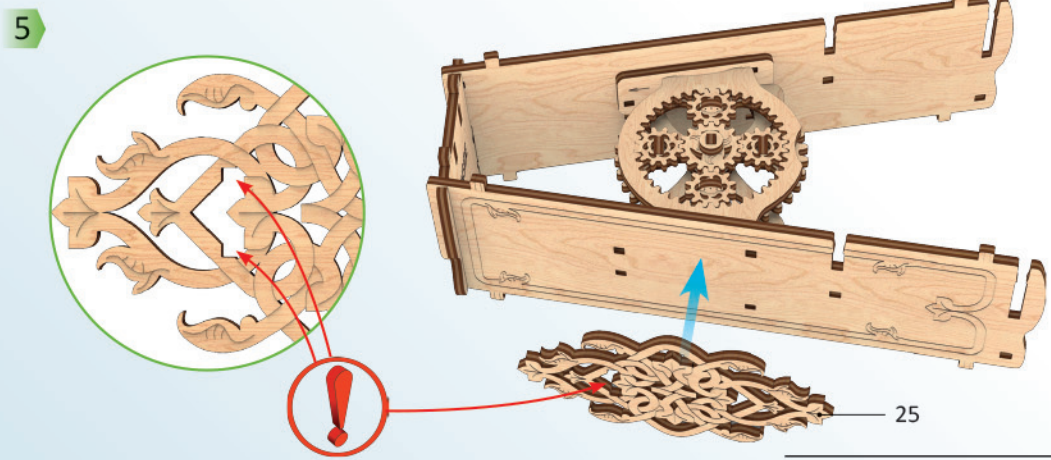
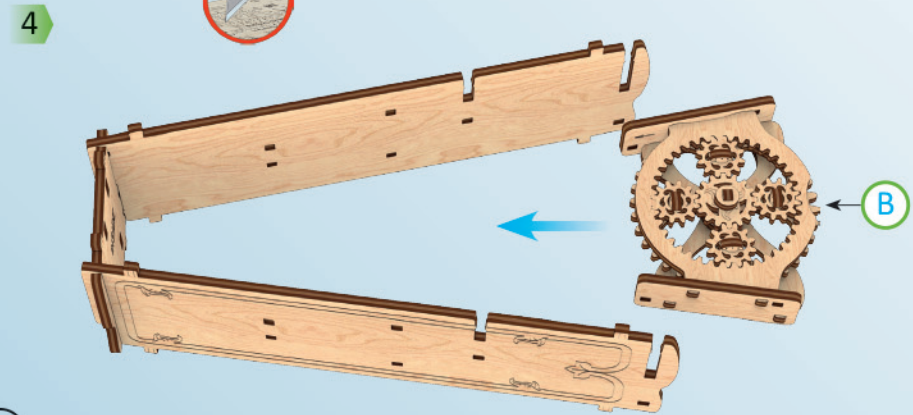
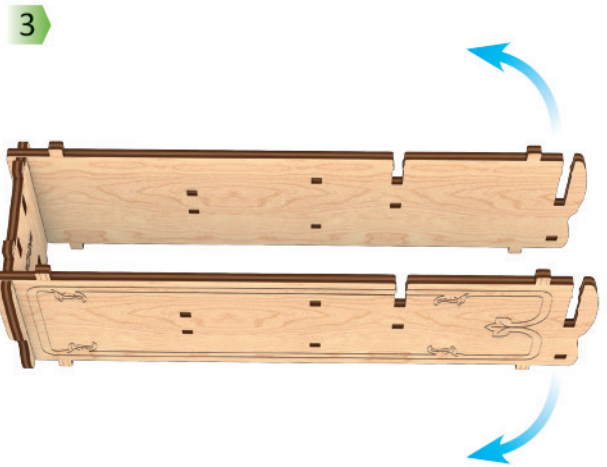
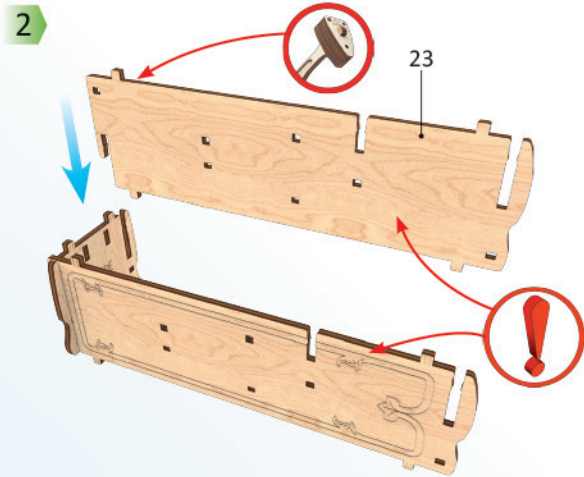
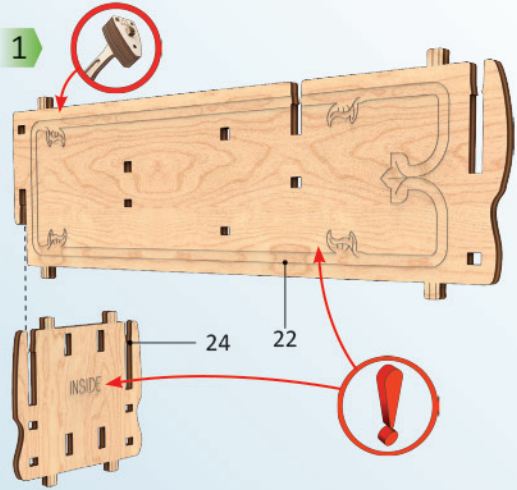
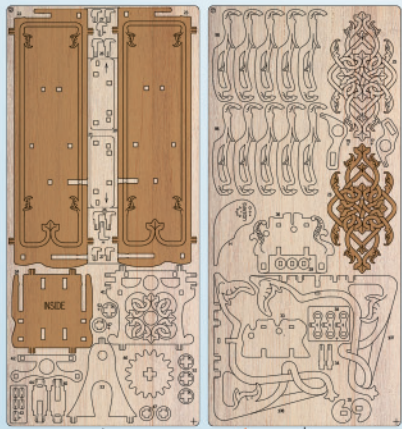

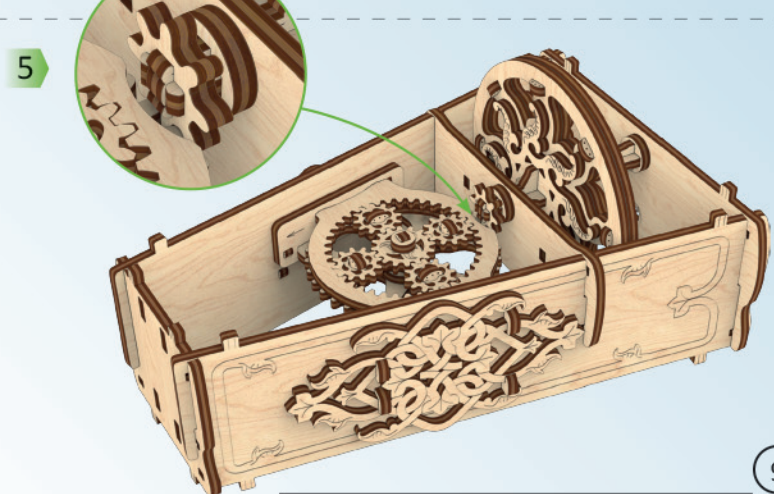
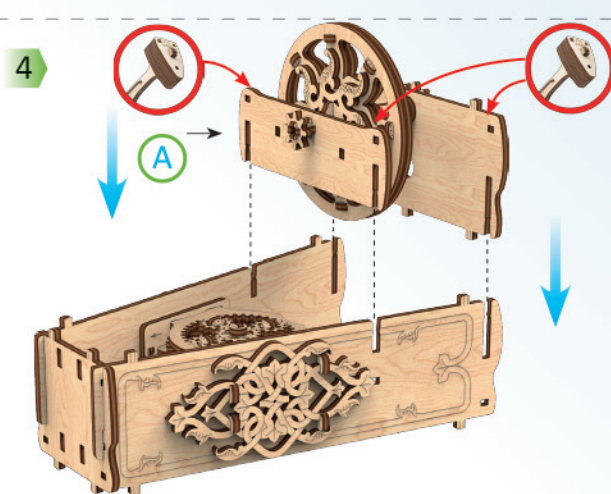
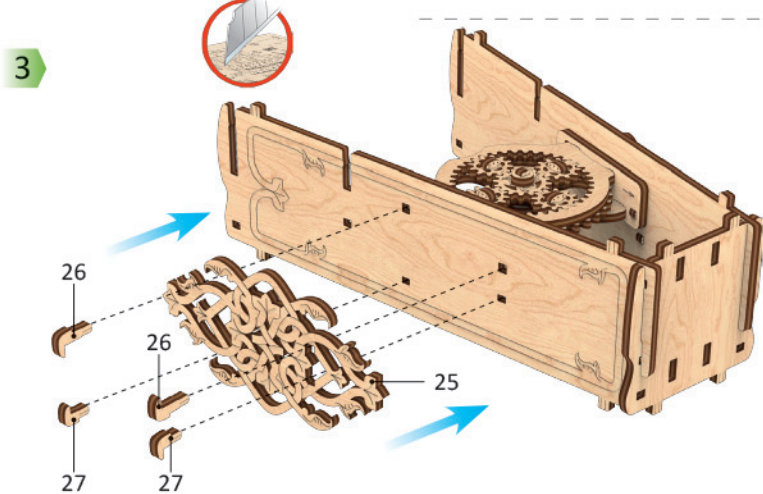
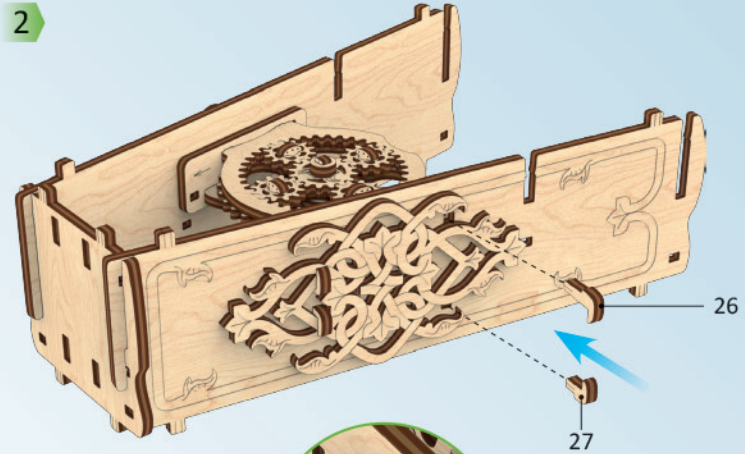
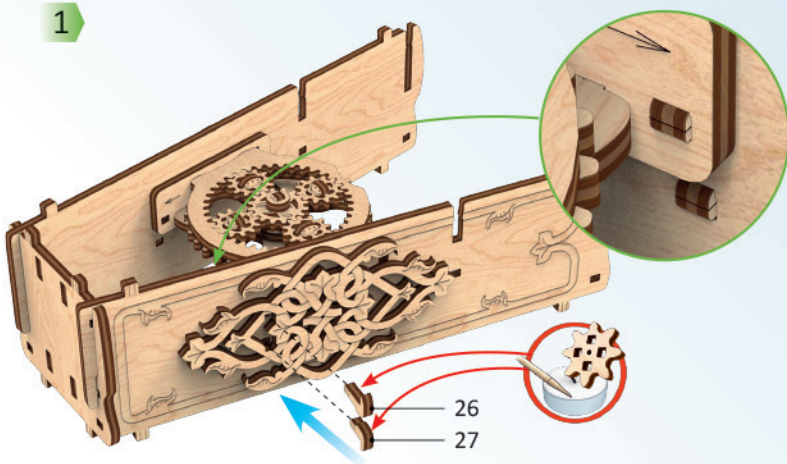
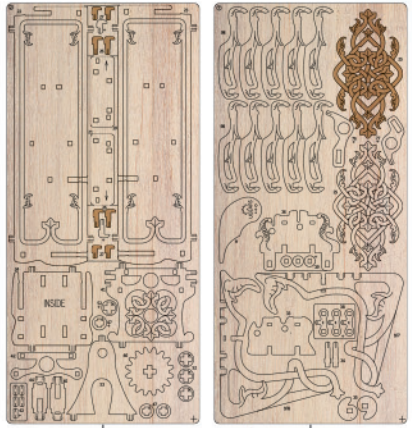

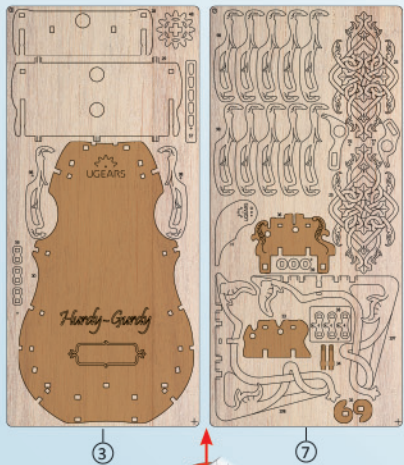

1

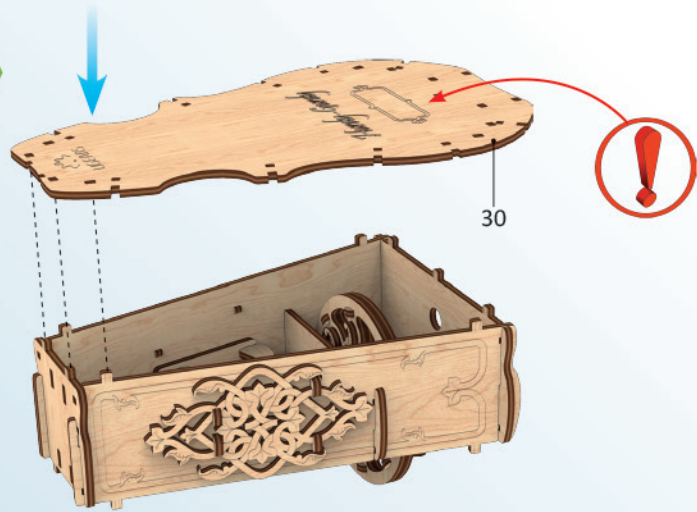

2

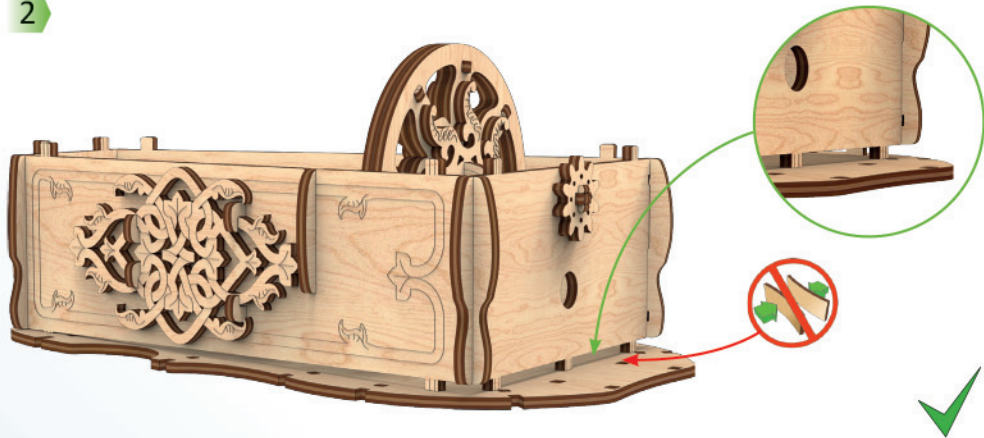

3

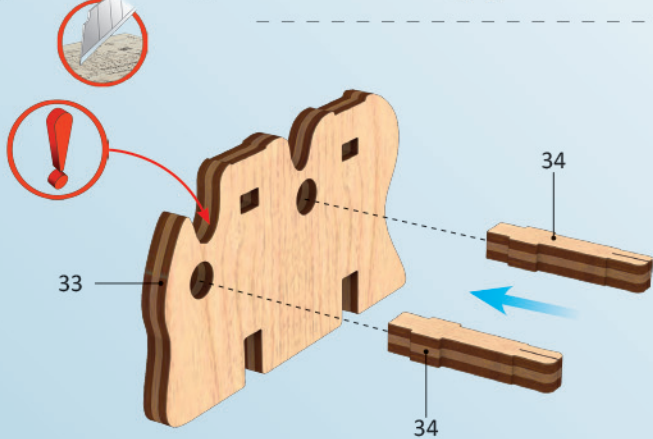

4

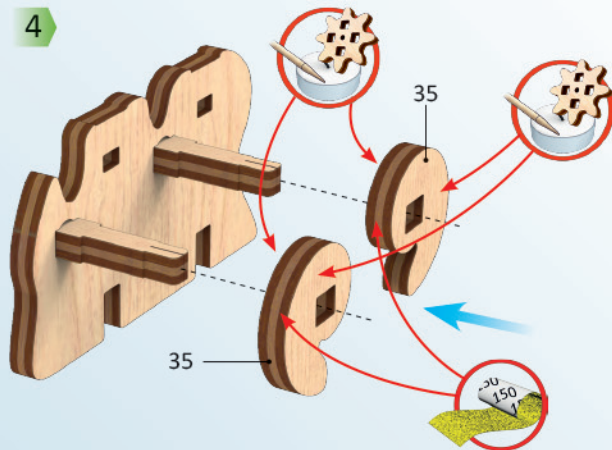

5

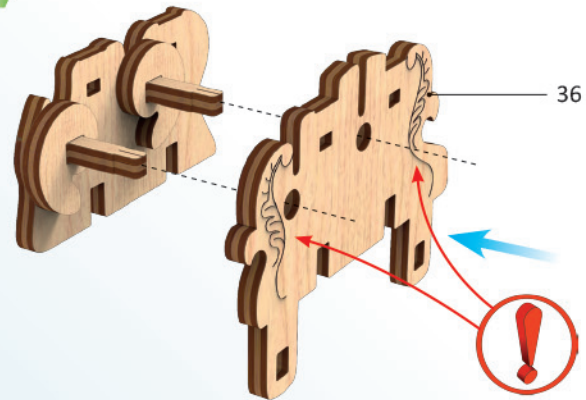

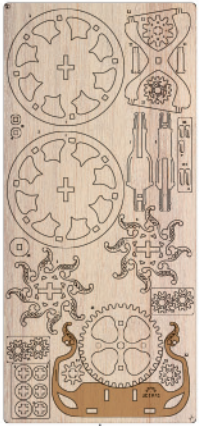

1



4

1

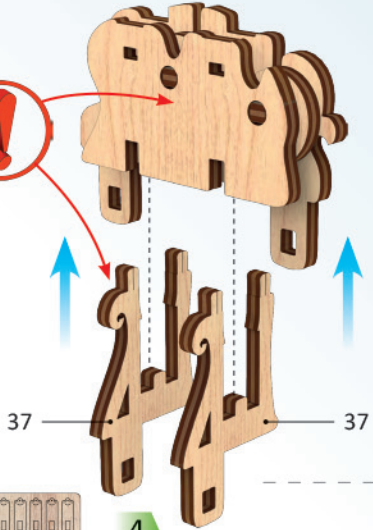

37

37

2

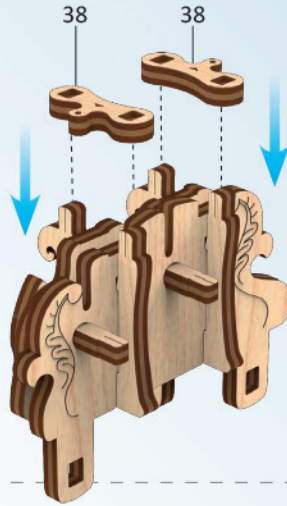

38

38

3

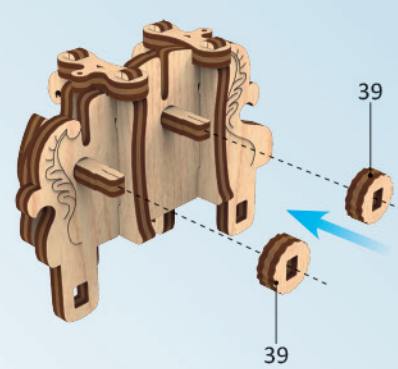

39

39

4

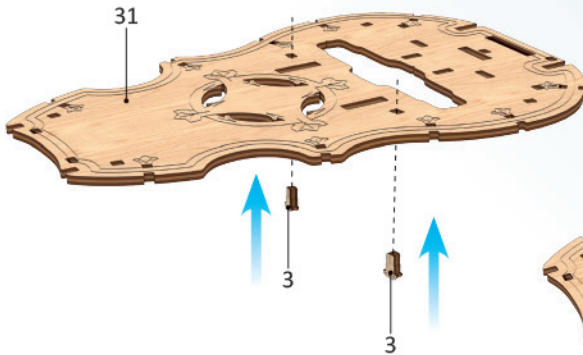

31

3

3

5

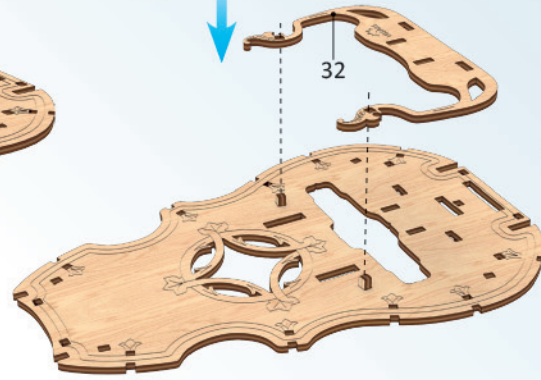

32

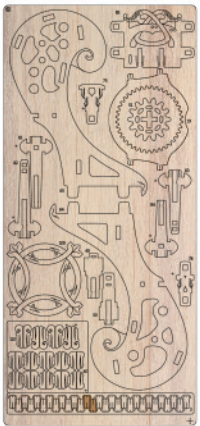

6

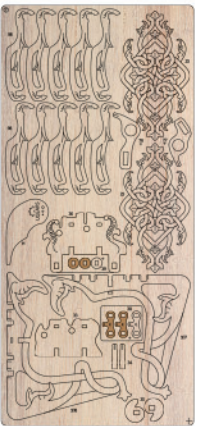

7

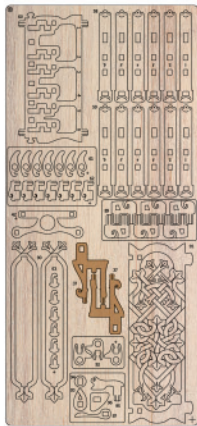

8

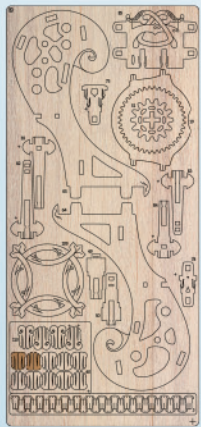

6

1

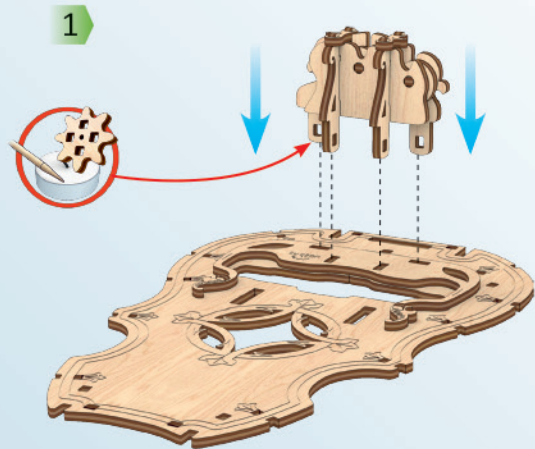

2

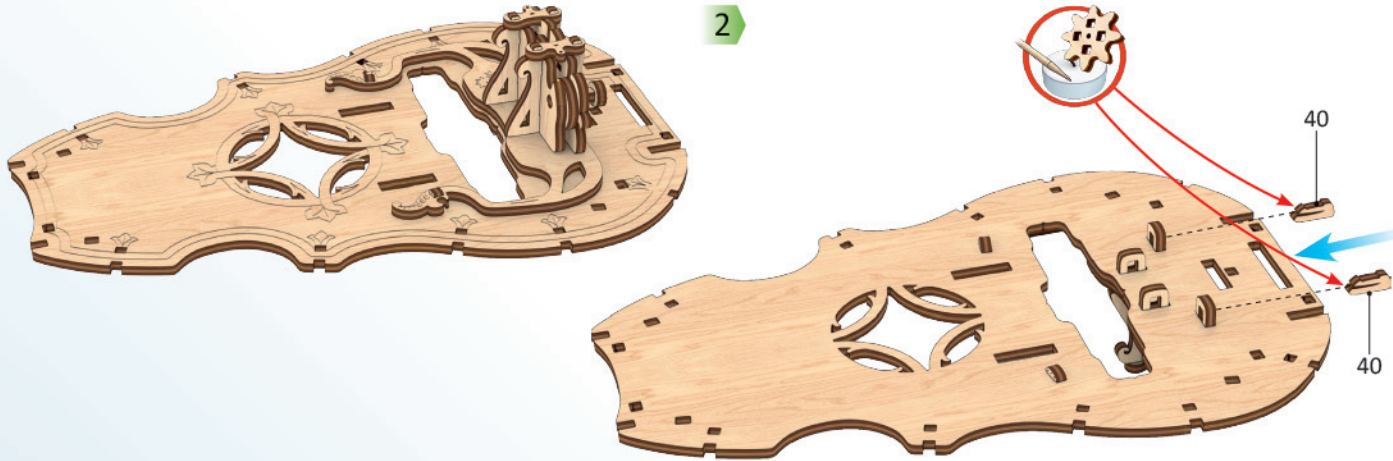

3

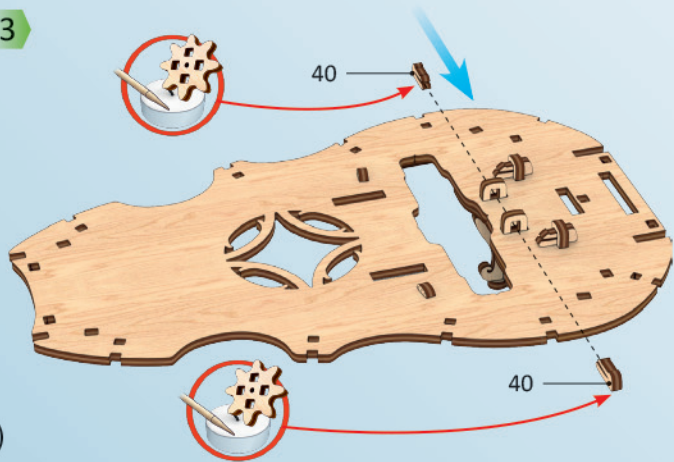

4

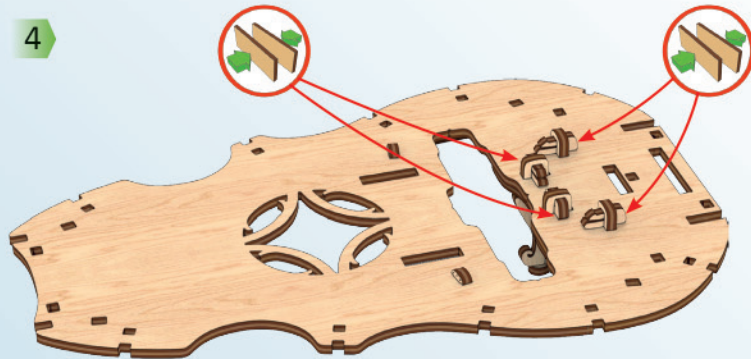

C



12

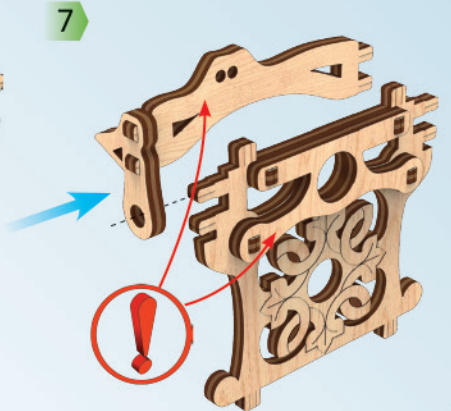
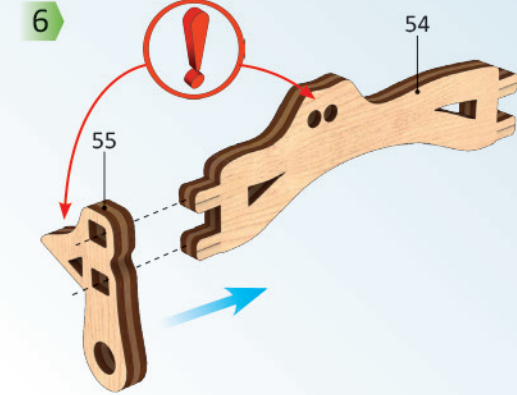
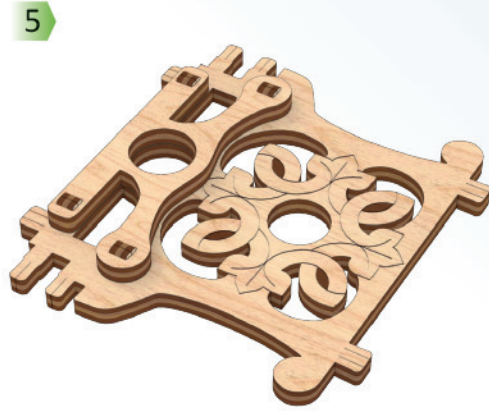
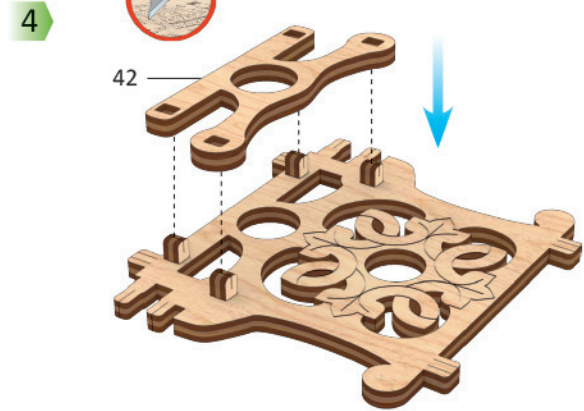
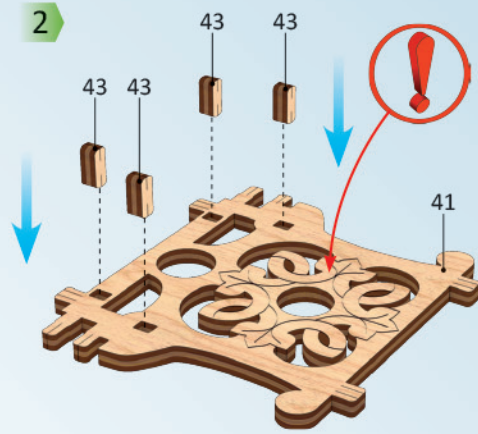
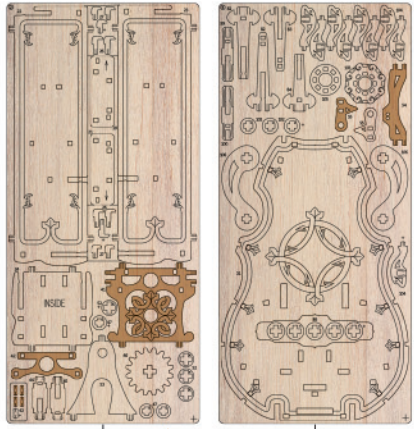

Mechanical models

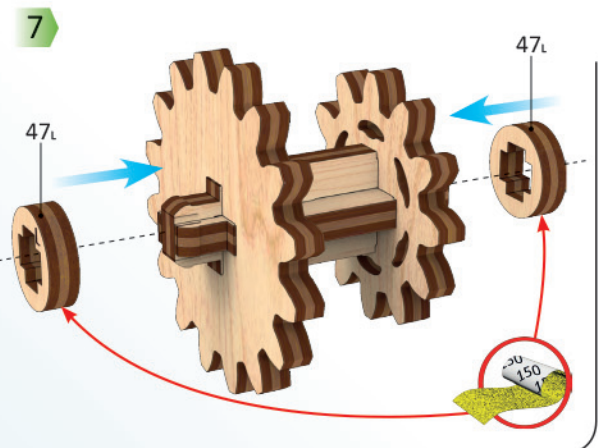
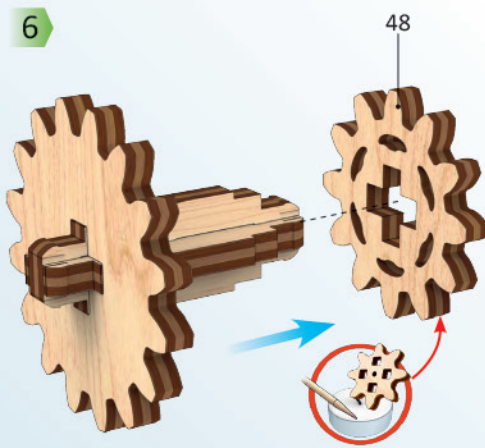
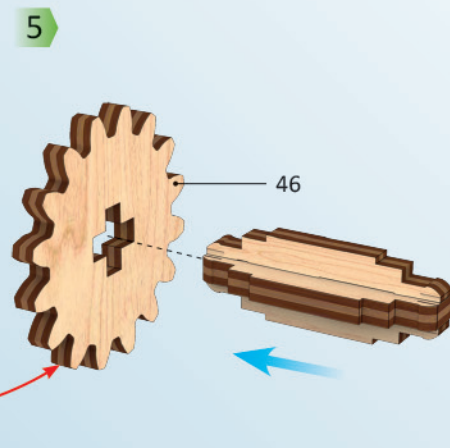
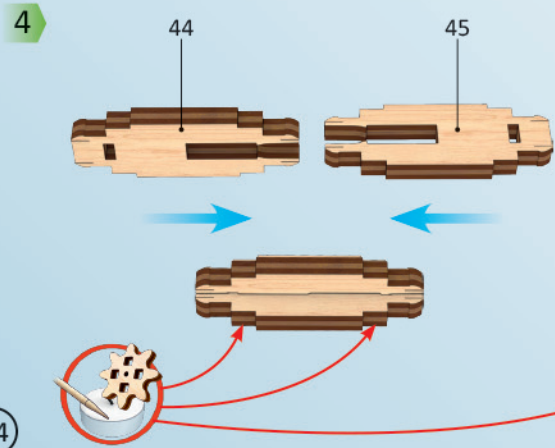
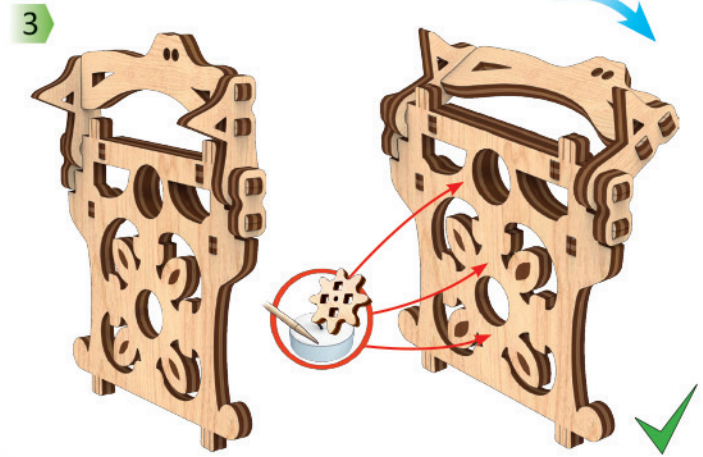
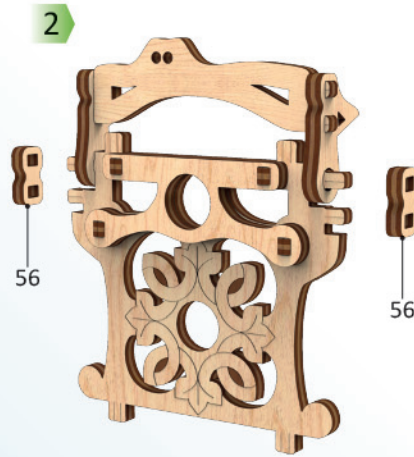
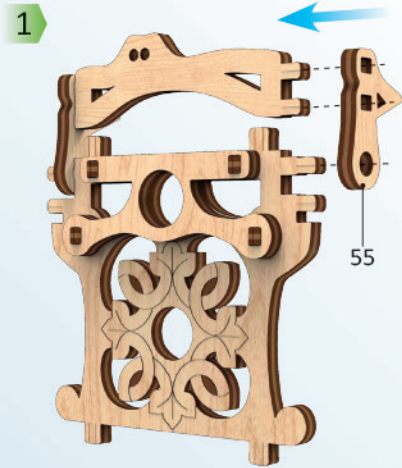
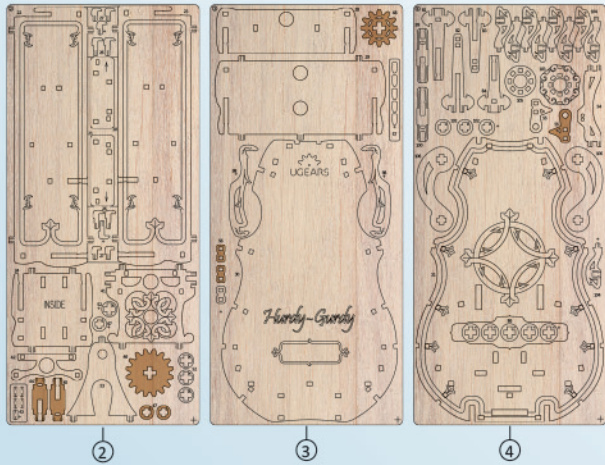

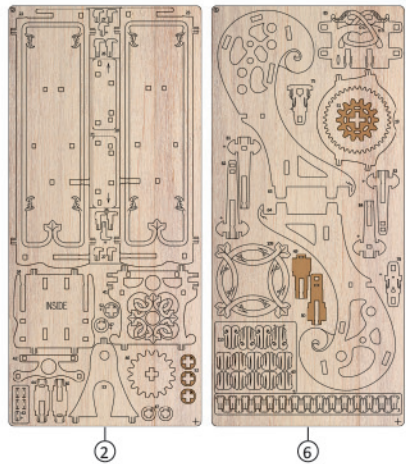

1

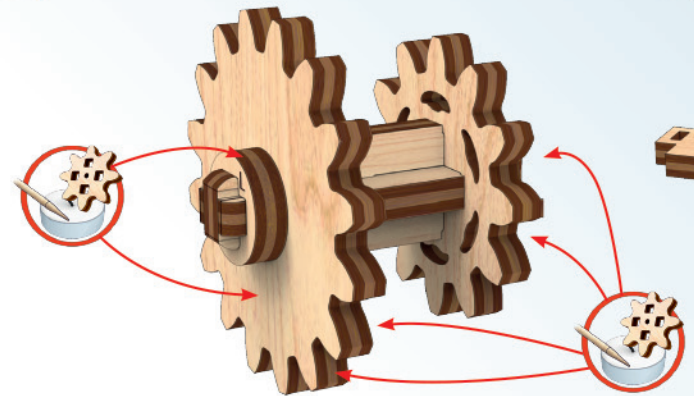

2

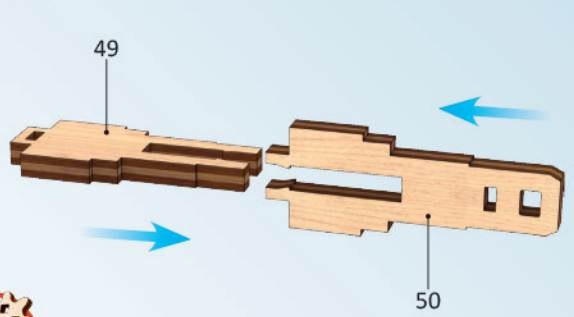

3

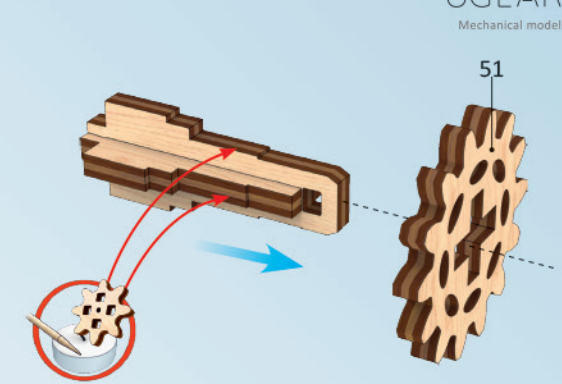

4

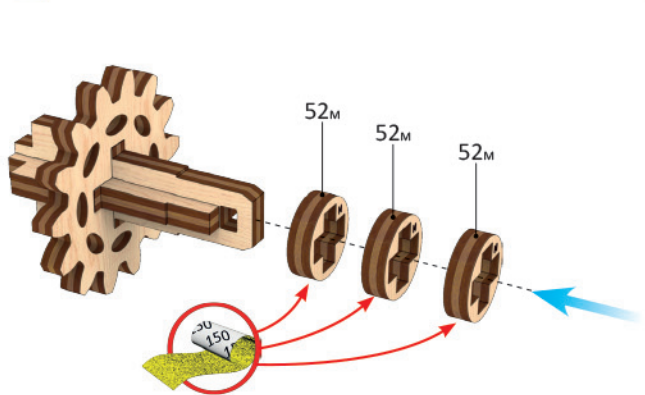

5

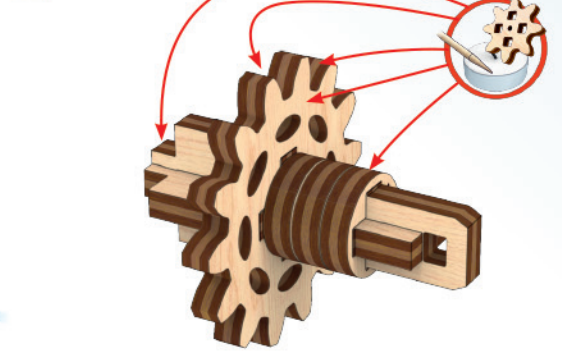

6

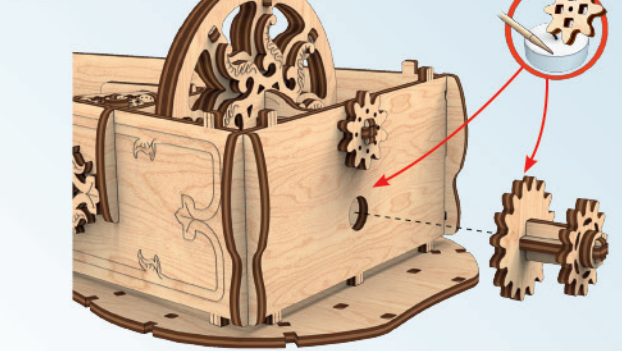

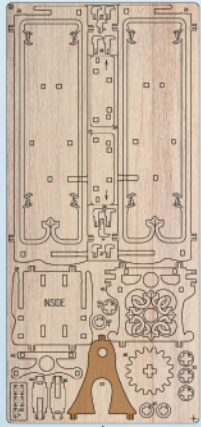

1

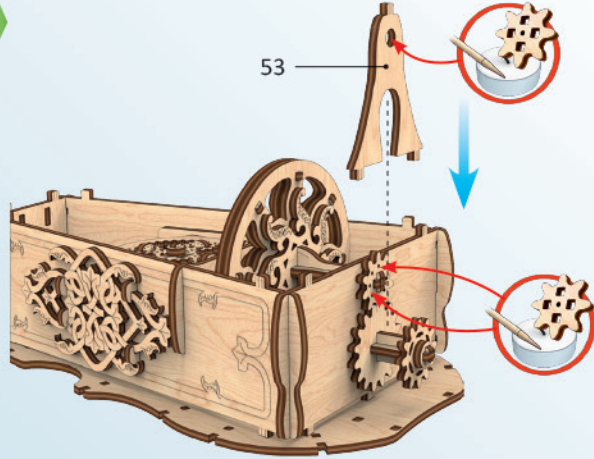

2

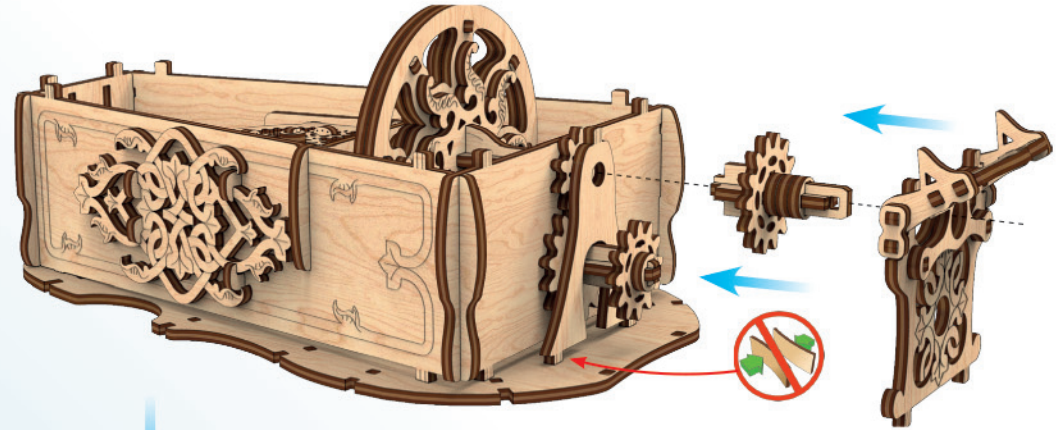

3

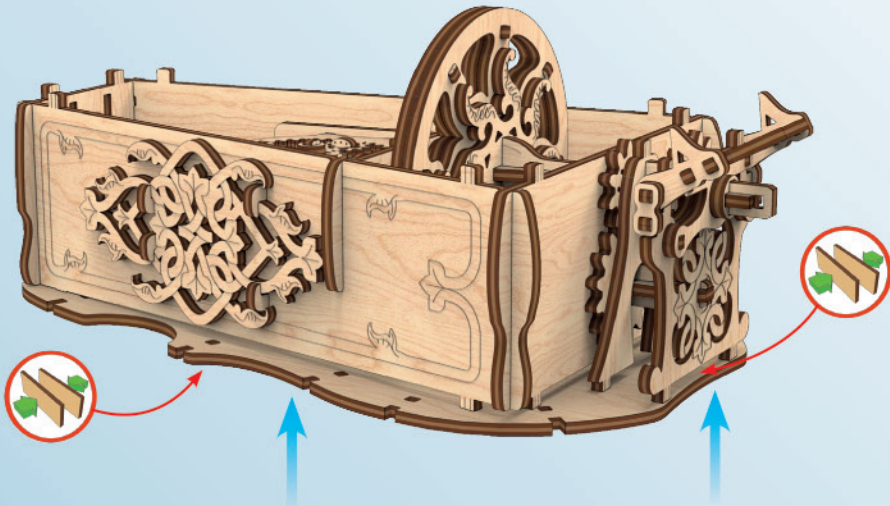

4

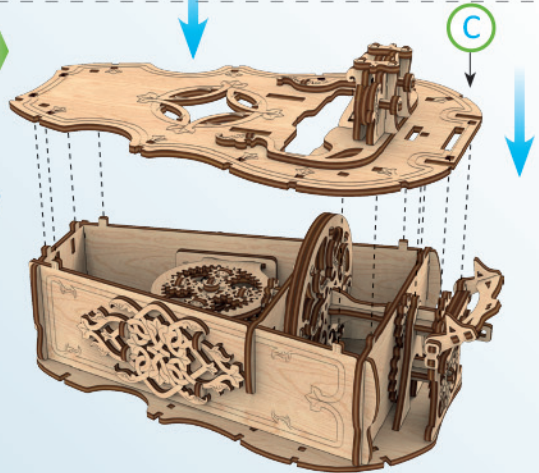

5

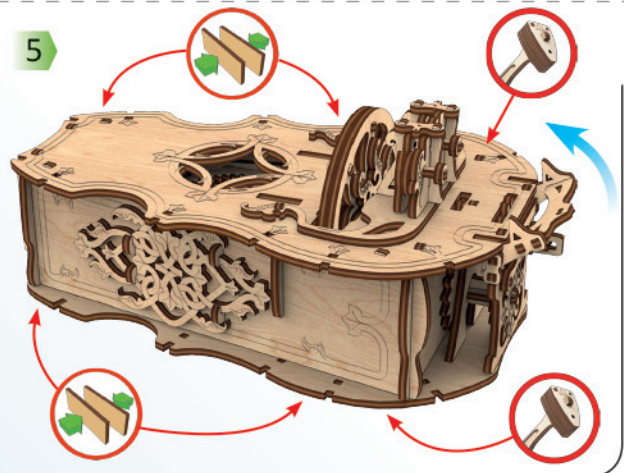



1

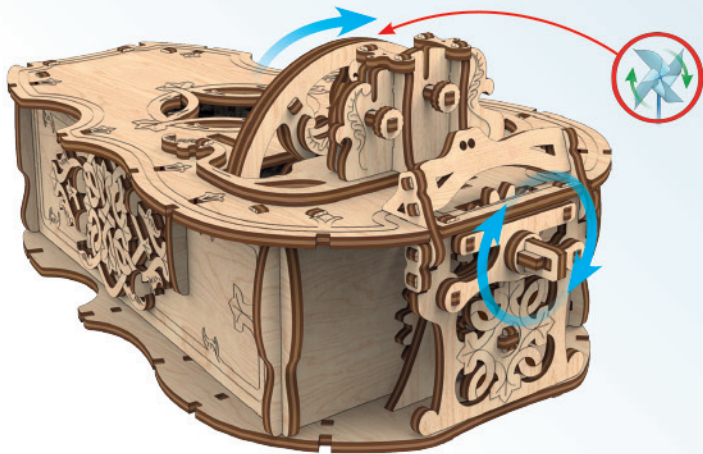

2



3

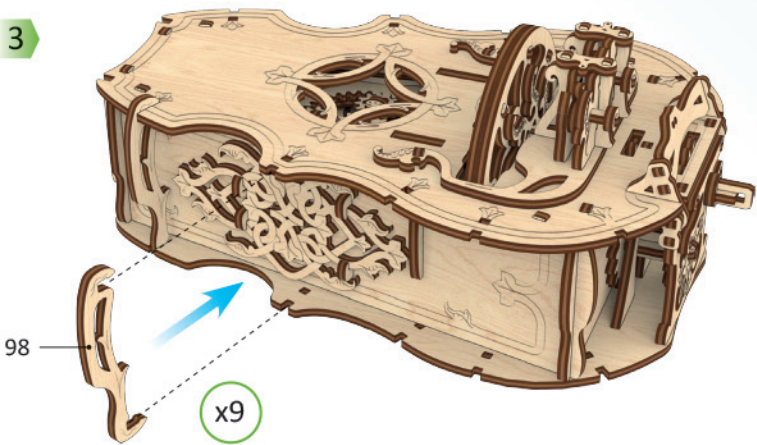

4

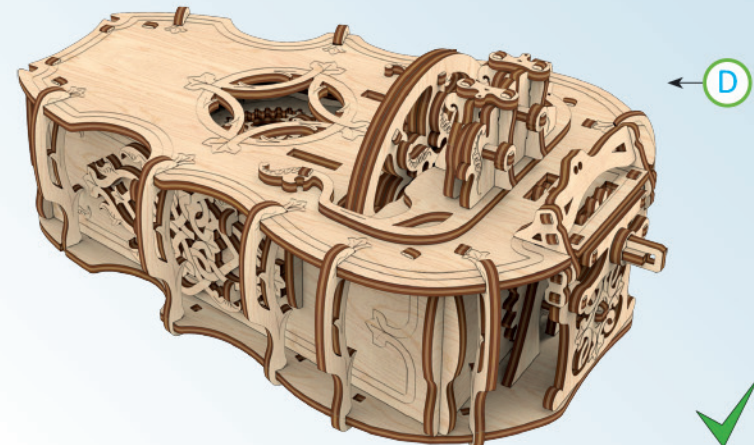

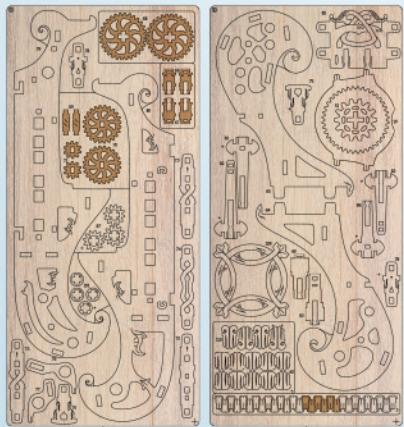

5

6

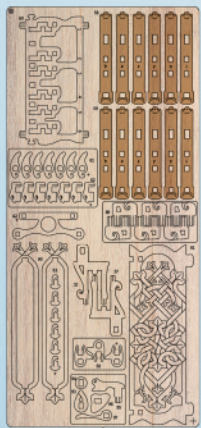
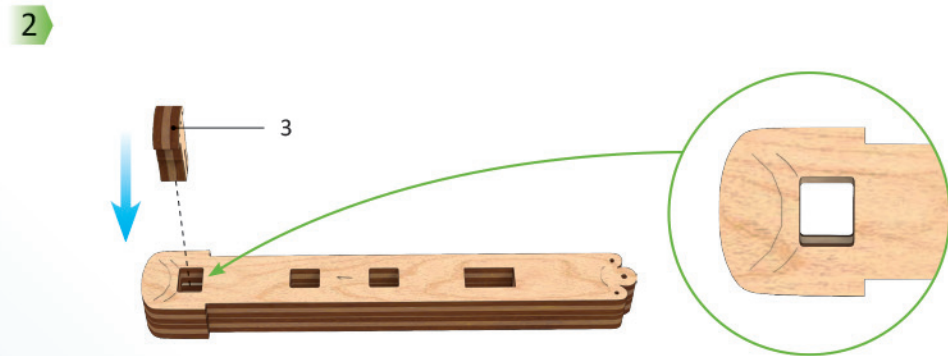
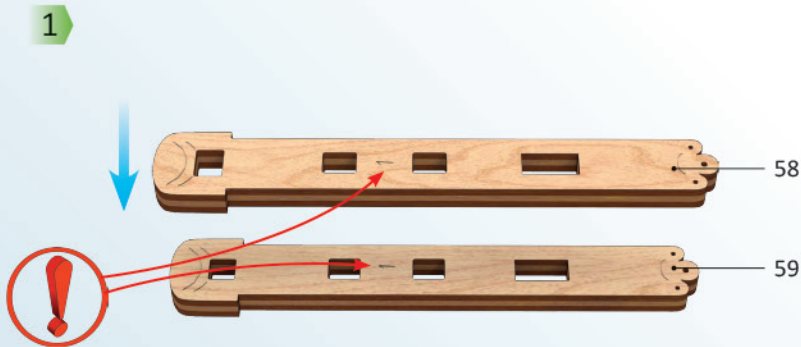

18

8

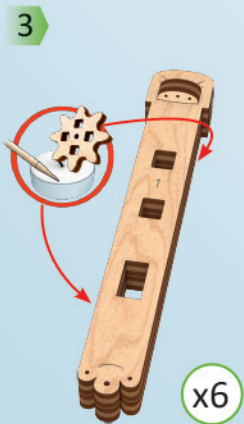

x6

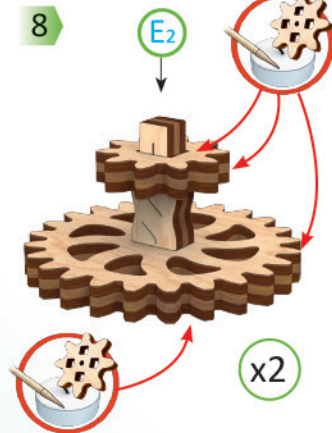
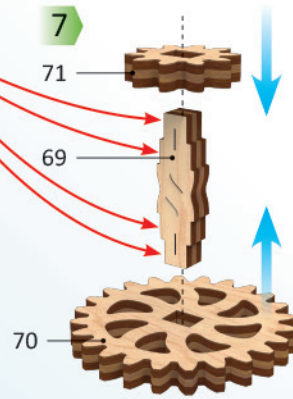
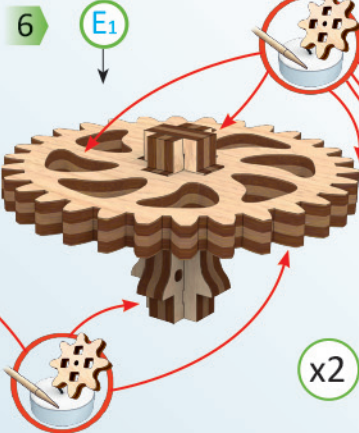
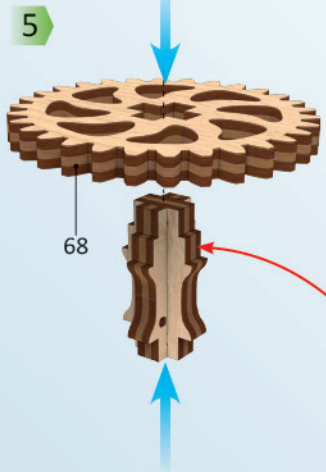
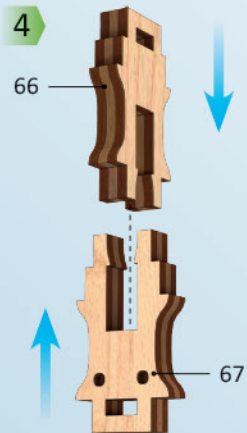



5

6

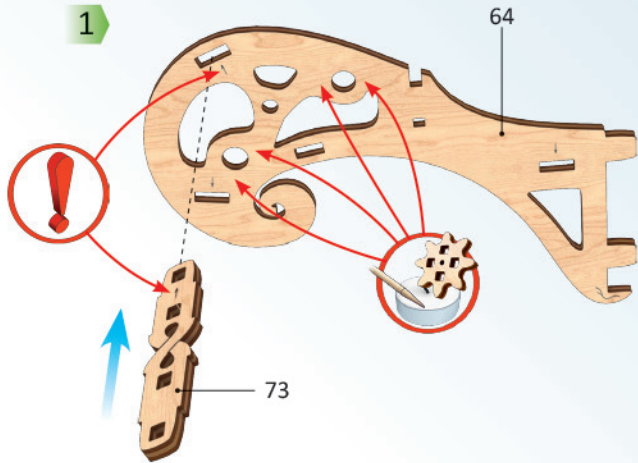

64

73

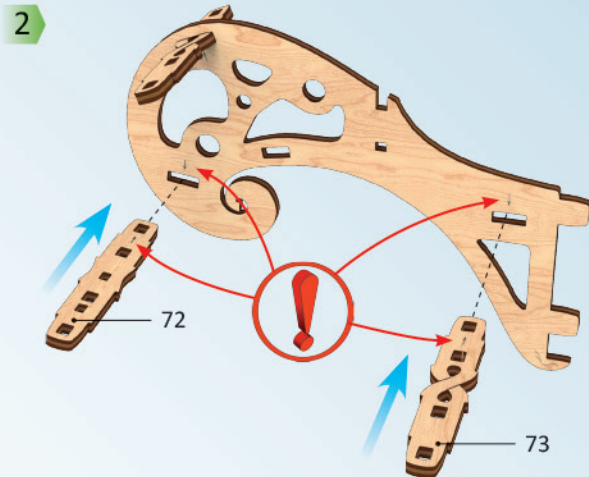

72

73

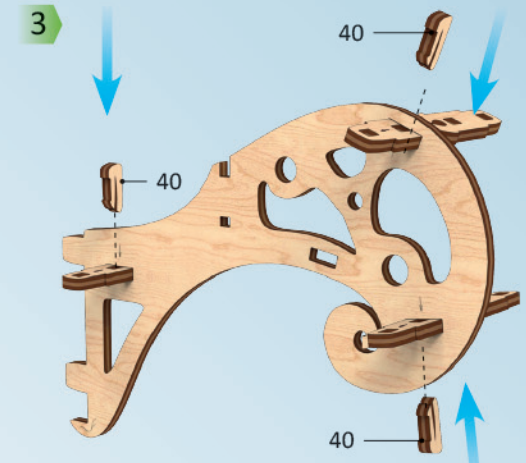

40

40

40

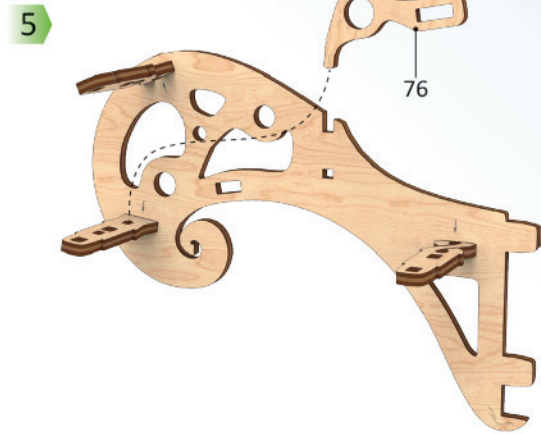

76



E1

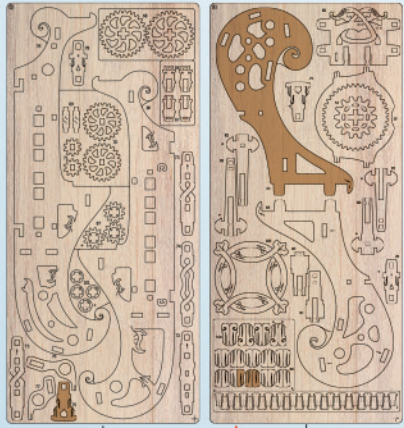

1

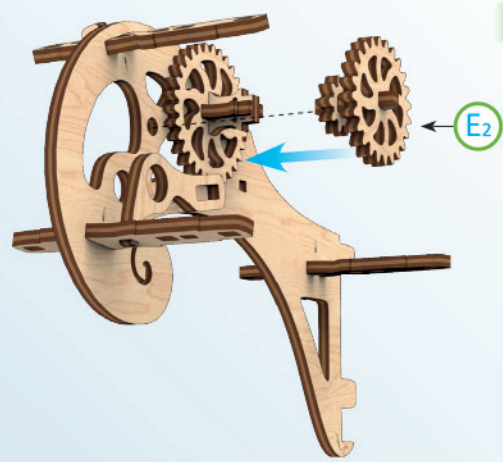

2

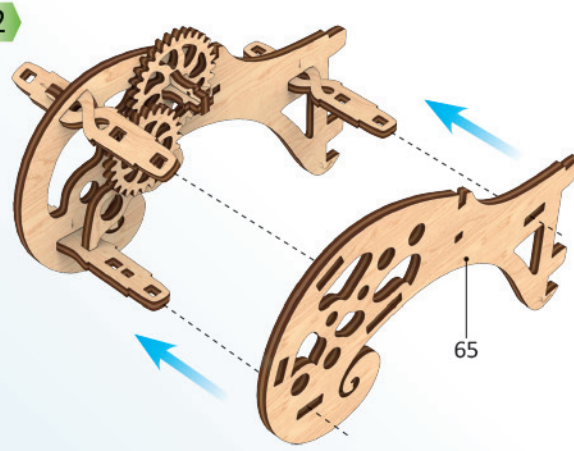

3

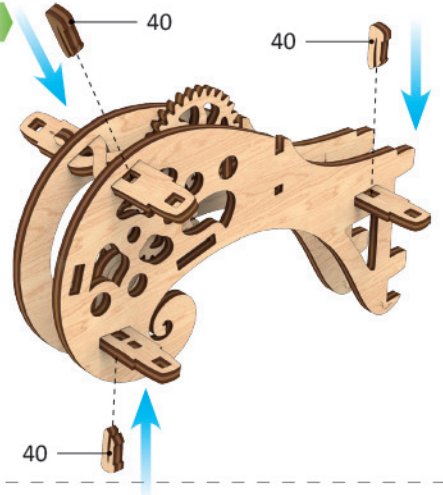

4

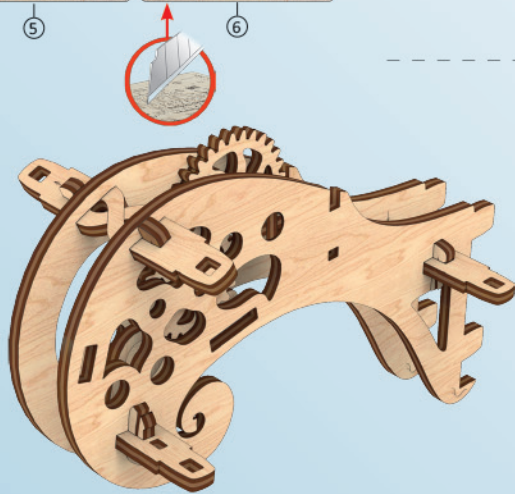

5

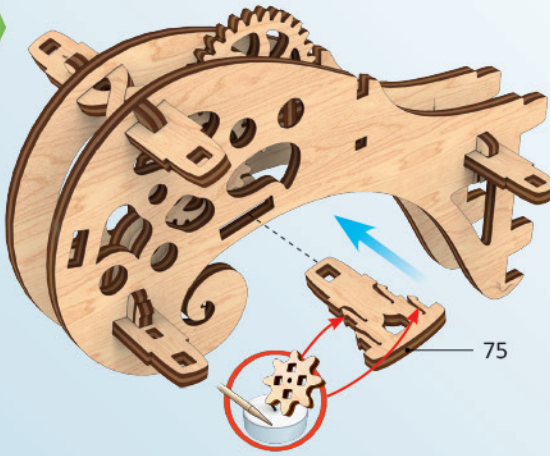

6

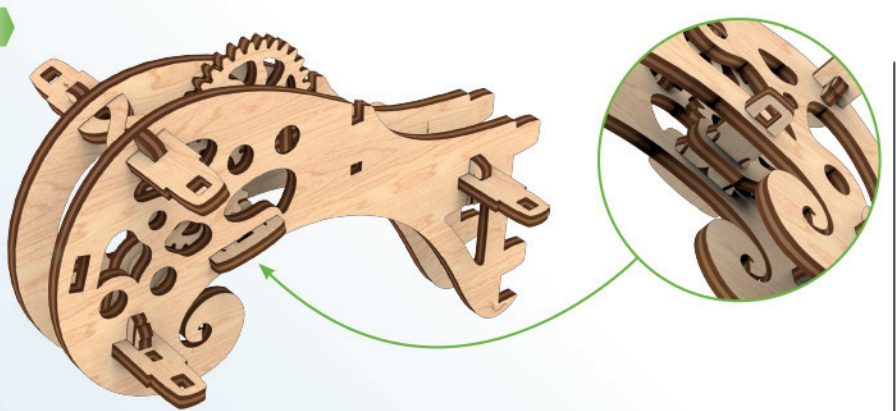

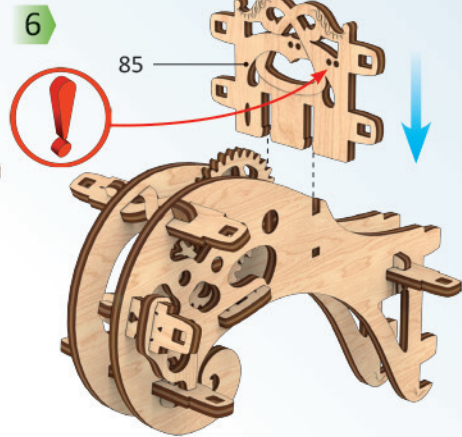
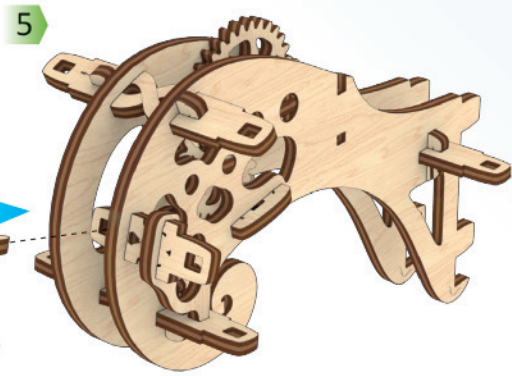
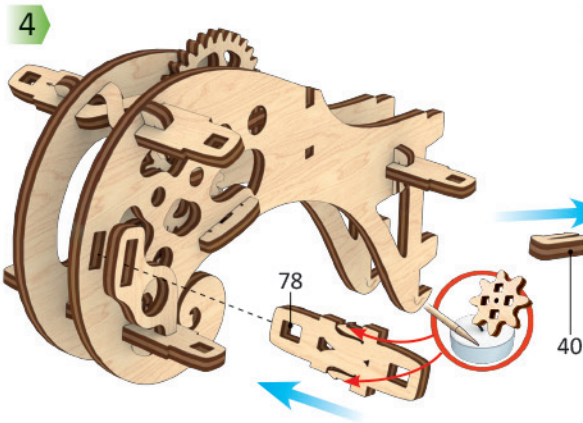
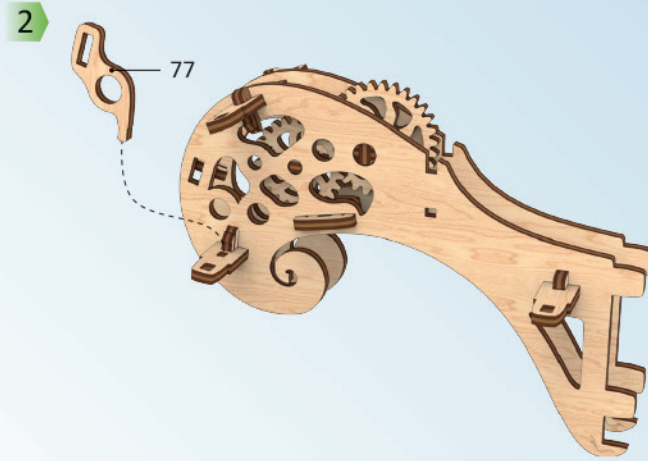
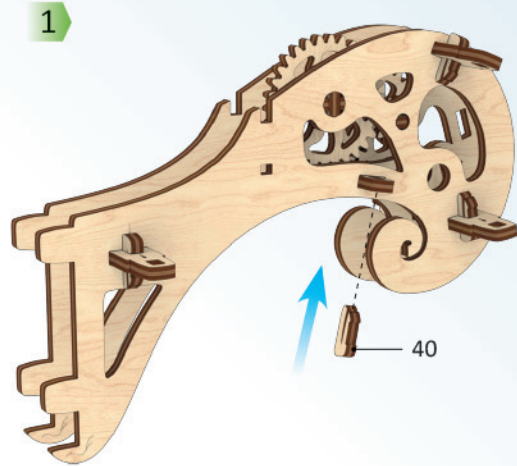
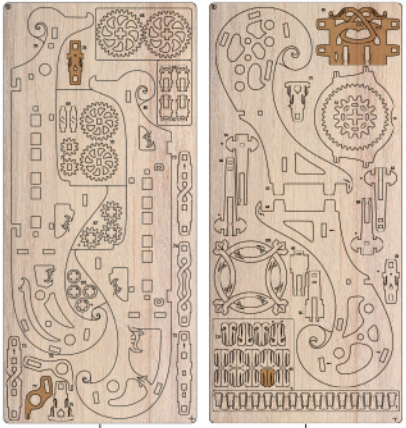

Mechanical models

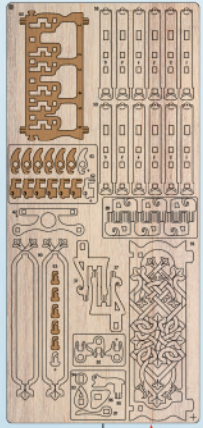

1

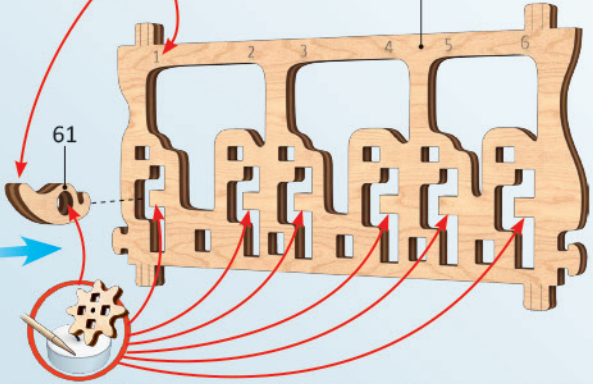

2

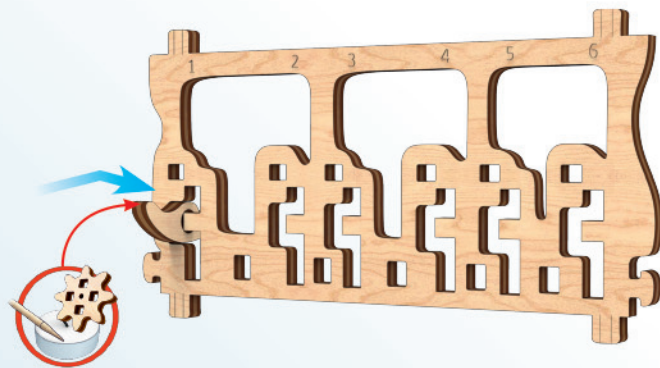

3

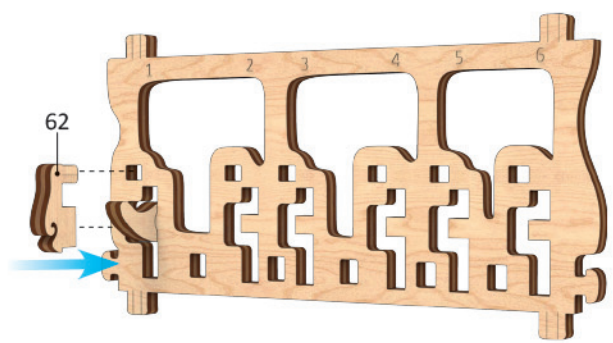

4

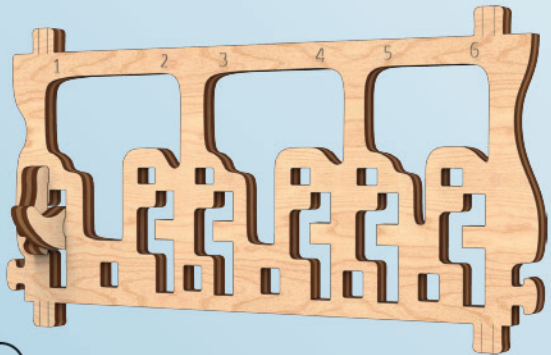

5



6

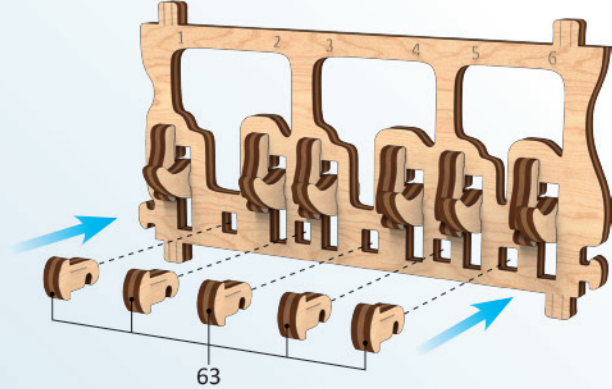

x6

1

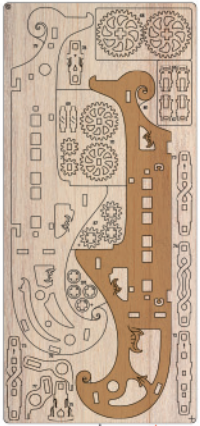

2

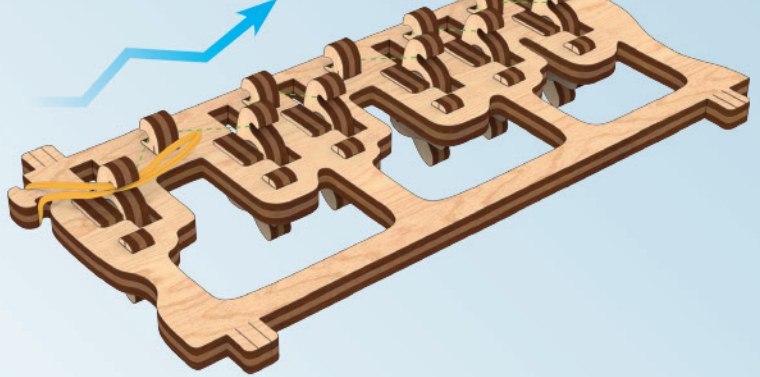

3

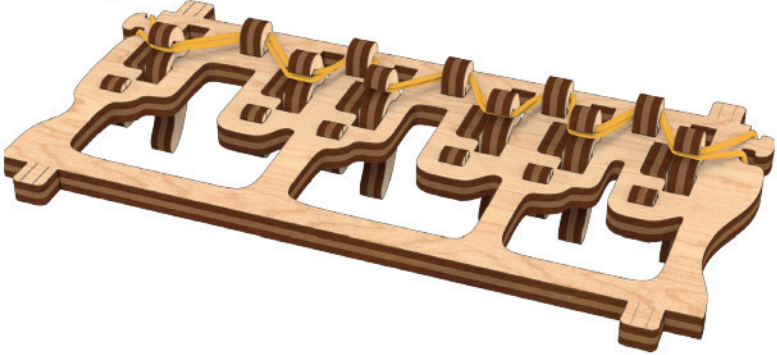

4

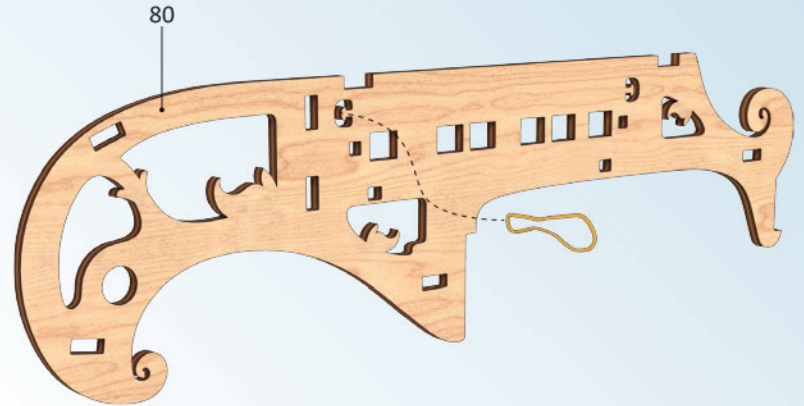

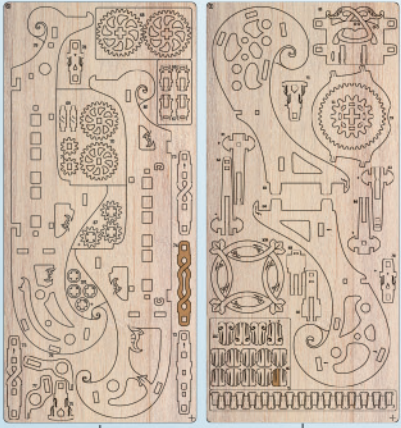

5

6

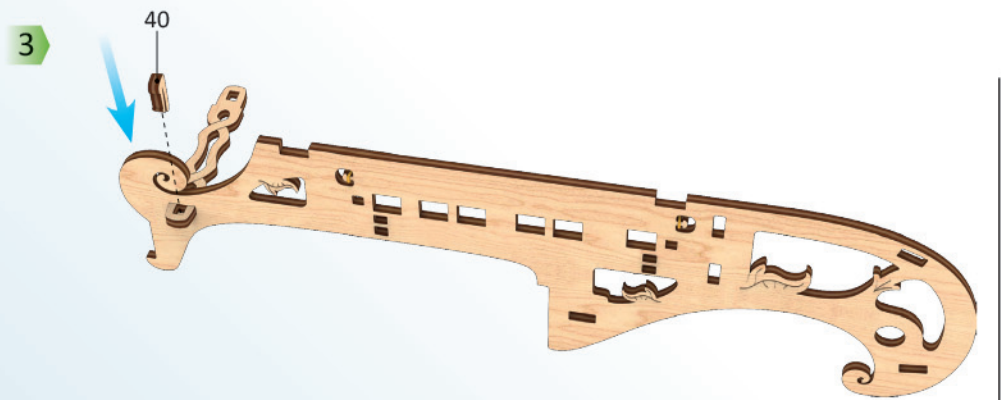
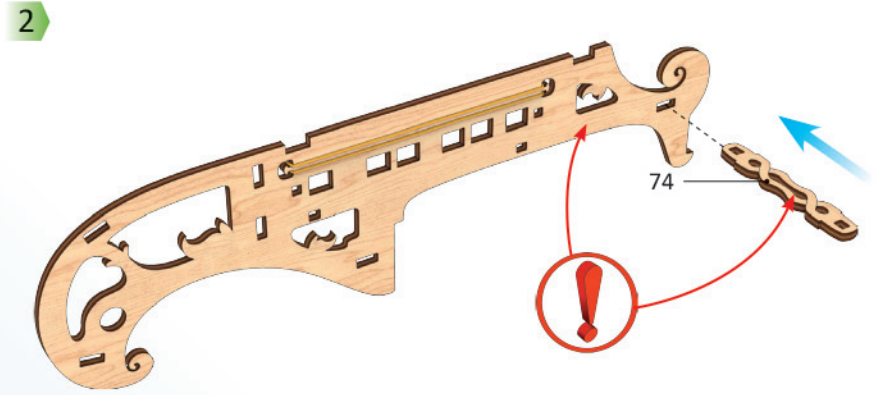
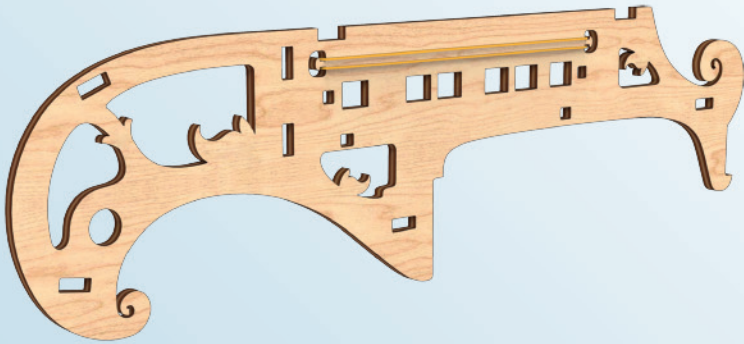
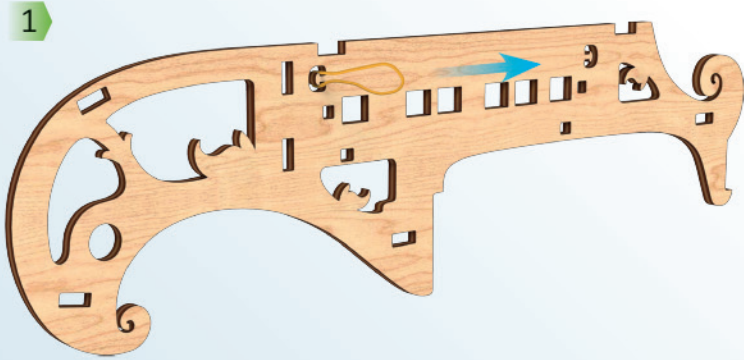

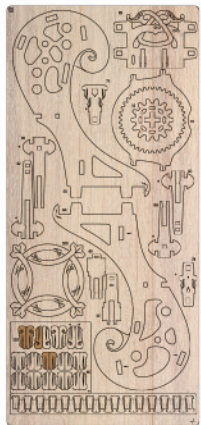

6

1

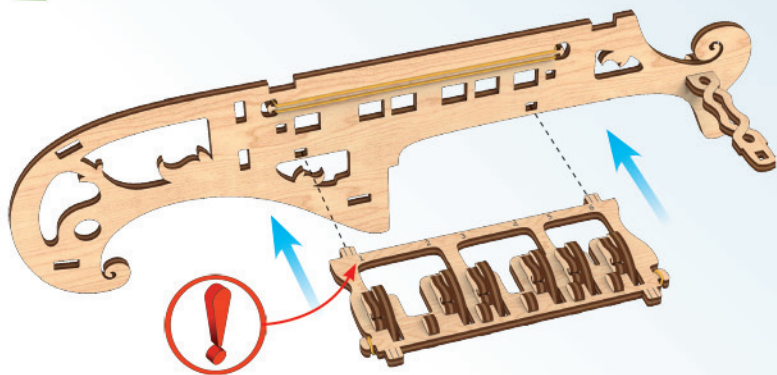

2

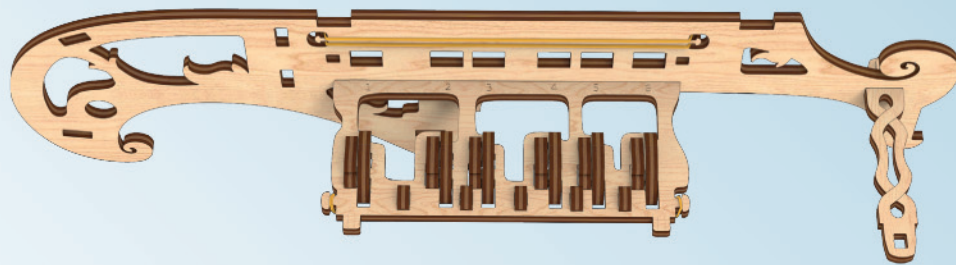

3

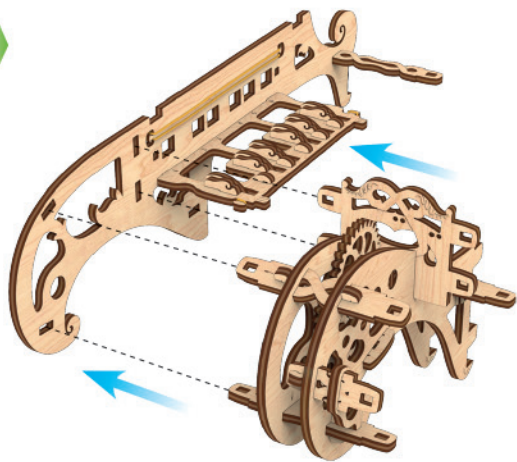

4

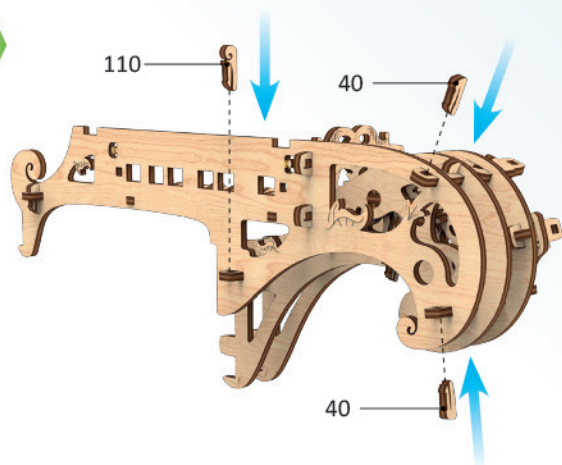

5

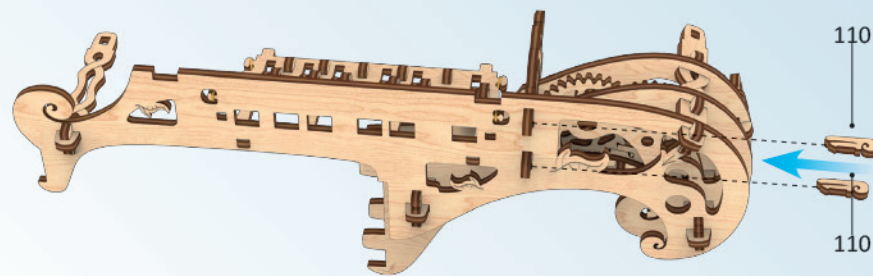

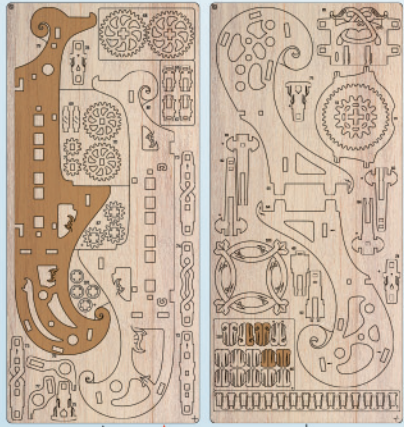

5

6

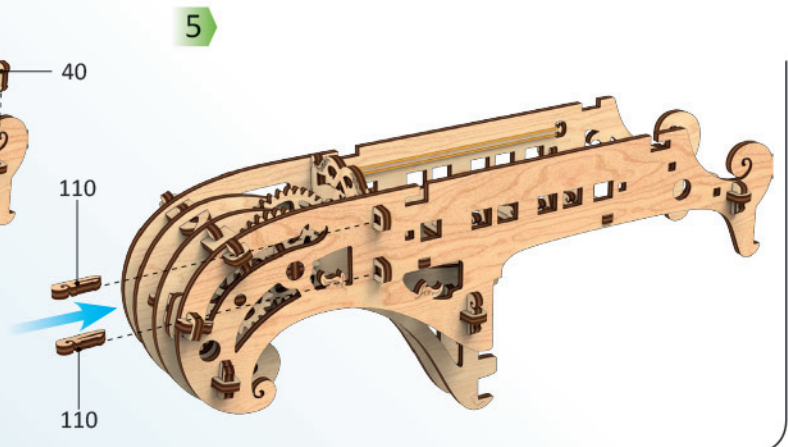
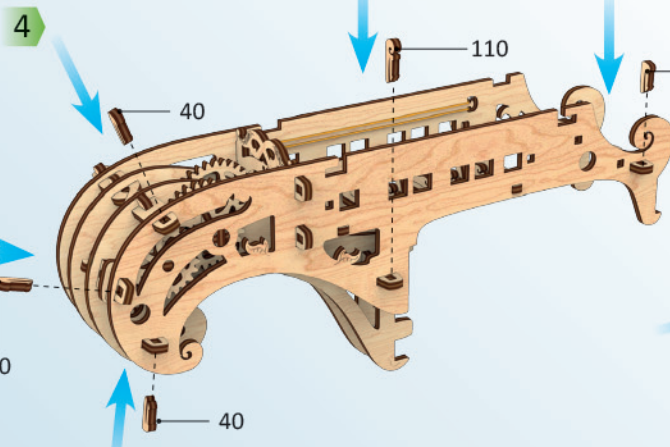
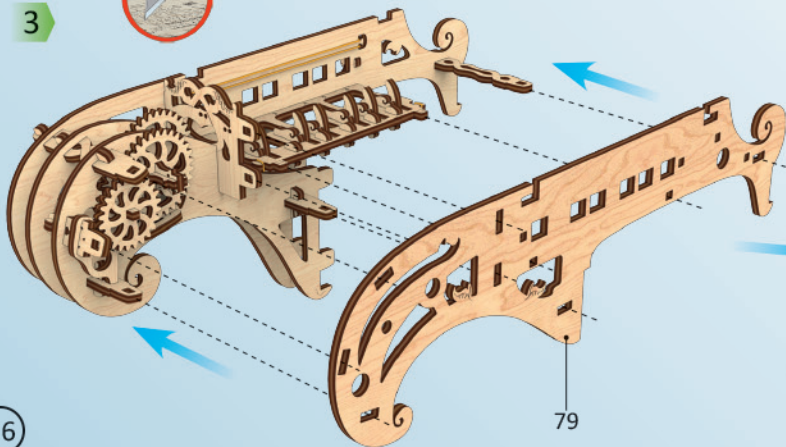
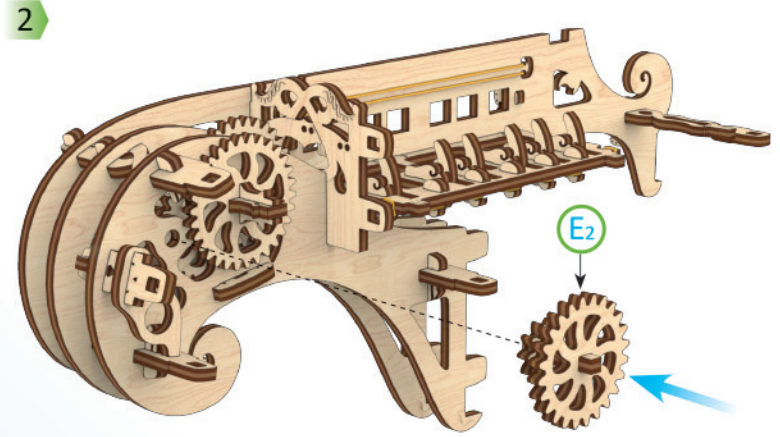
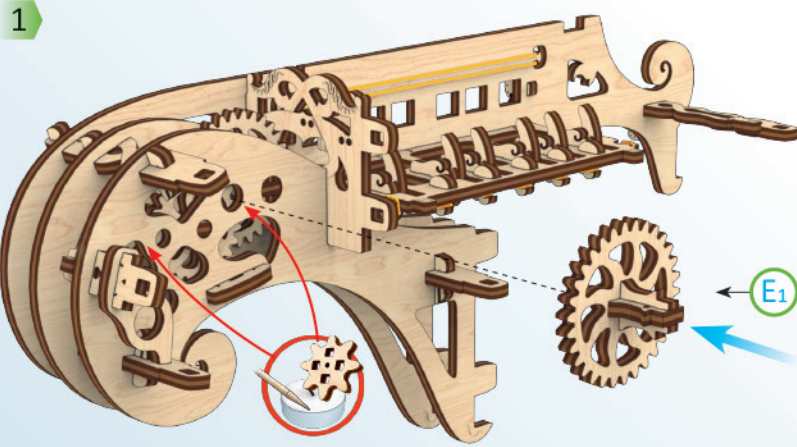

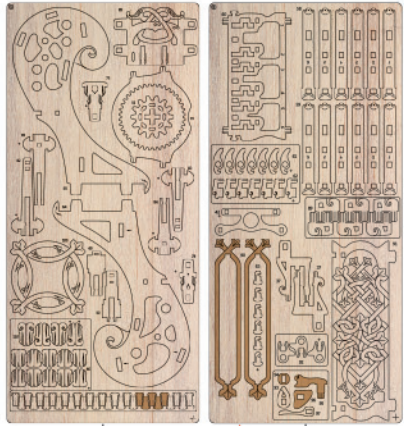

1

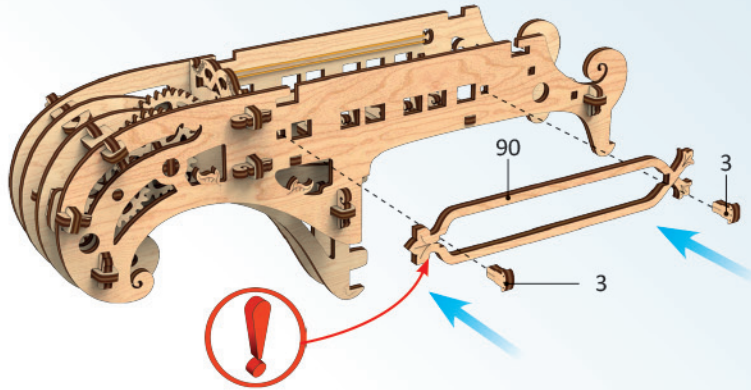

2



3

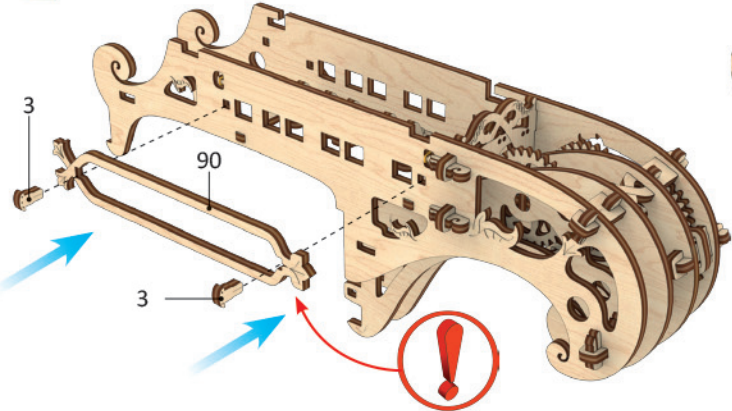

4

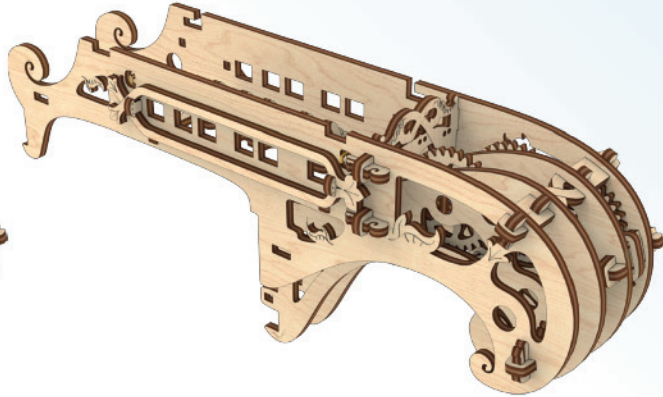

5

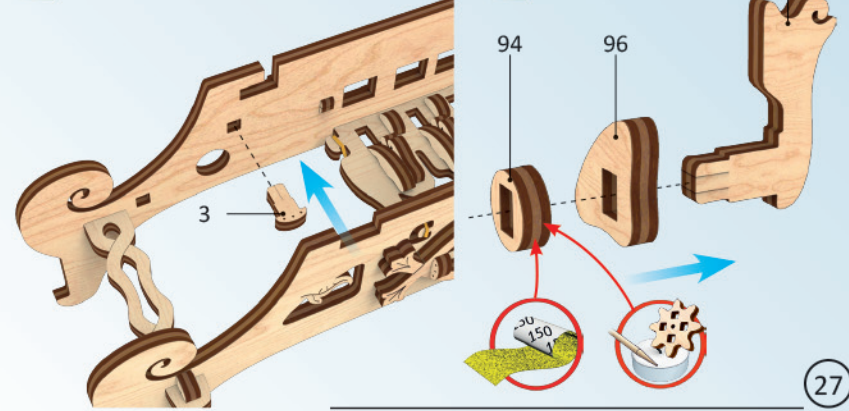

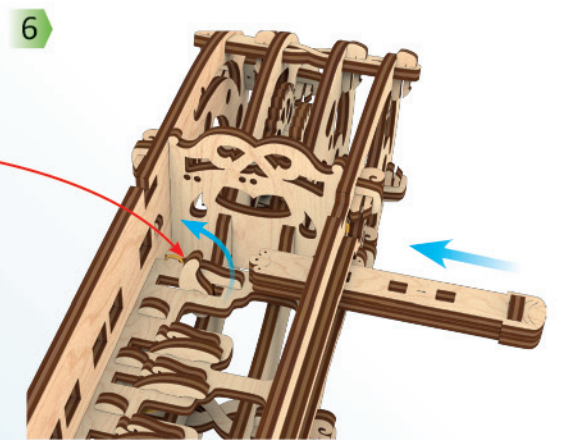
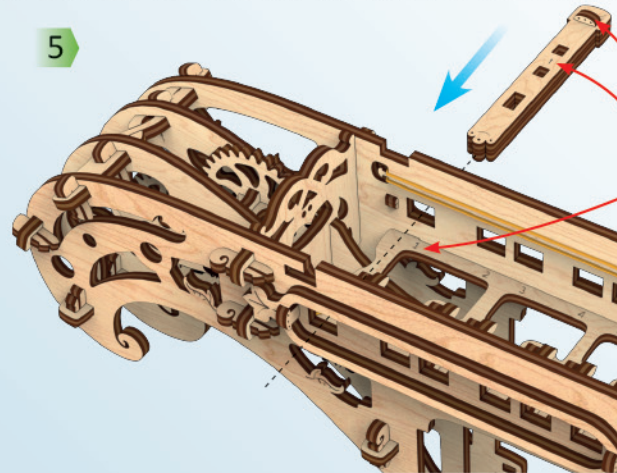
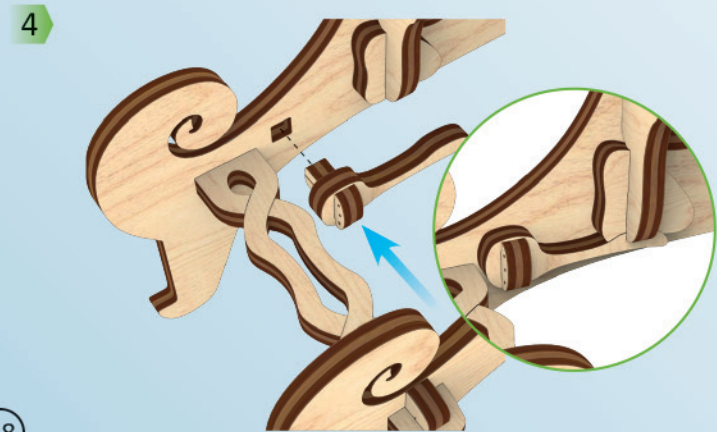
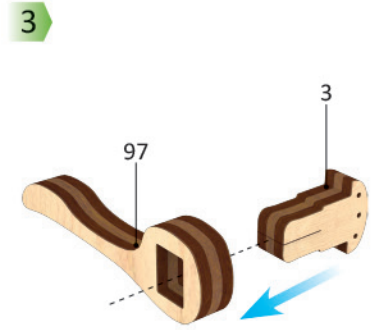
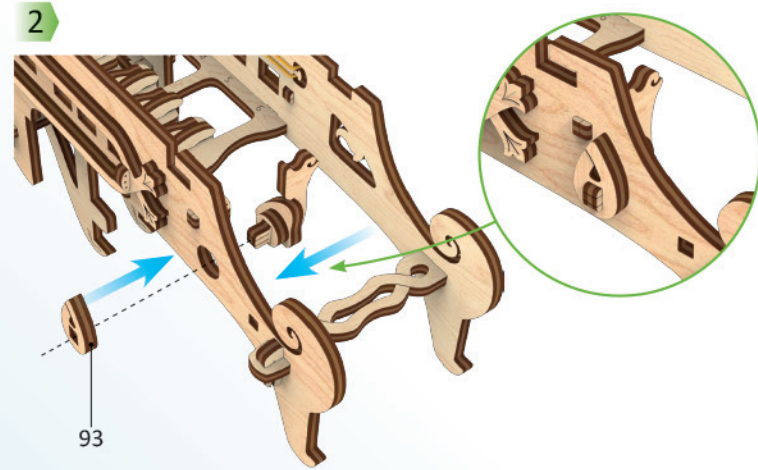
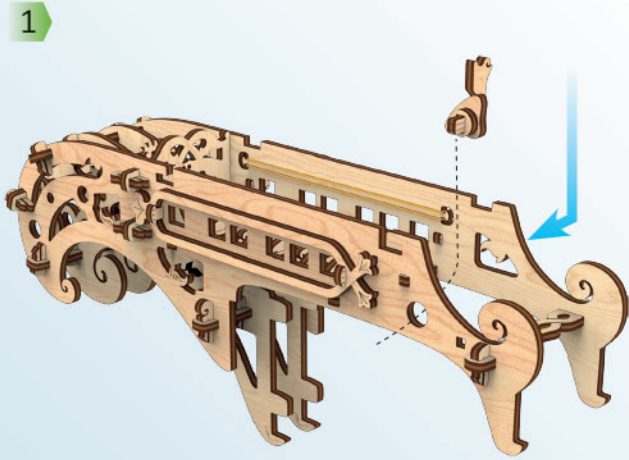
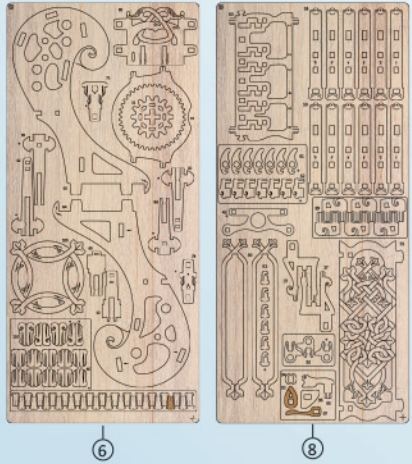

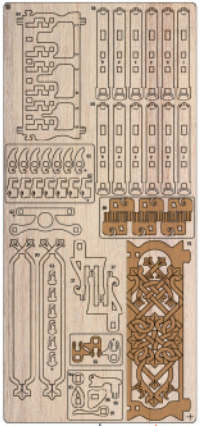

1

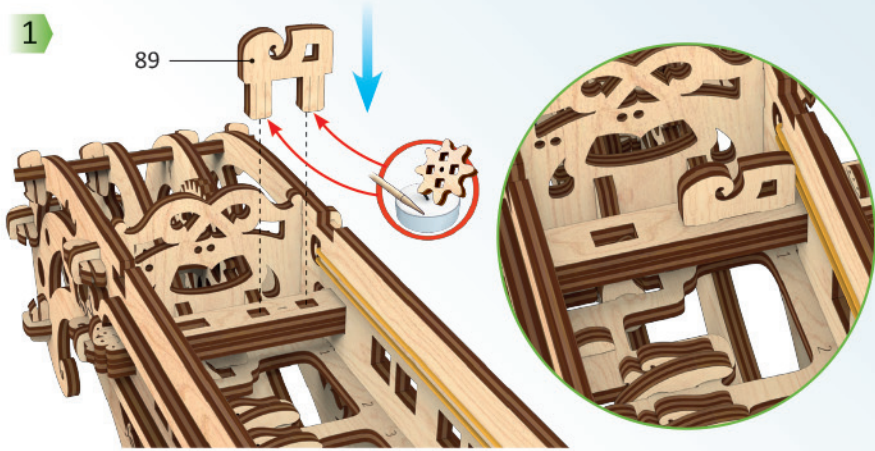

2

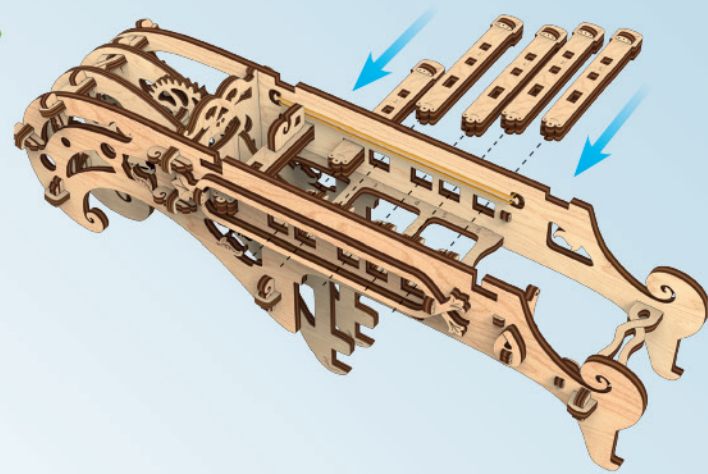

3

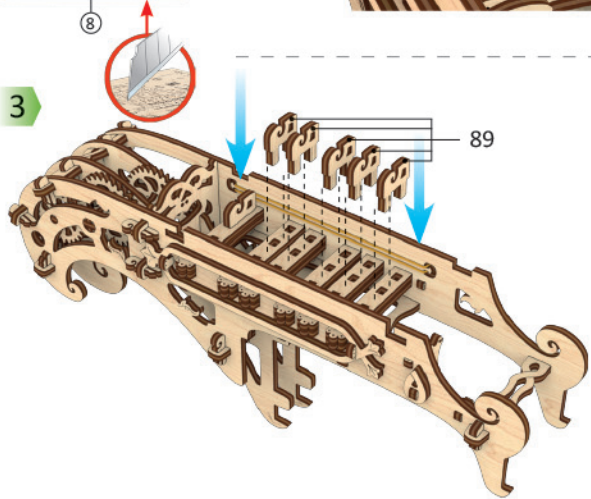

4

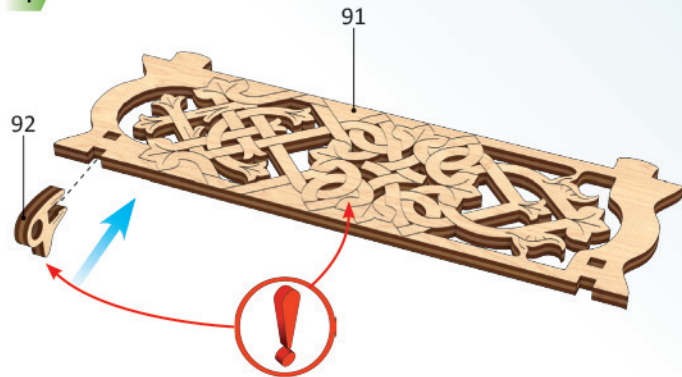

5

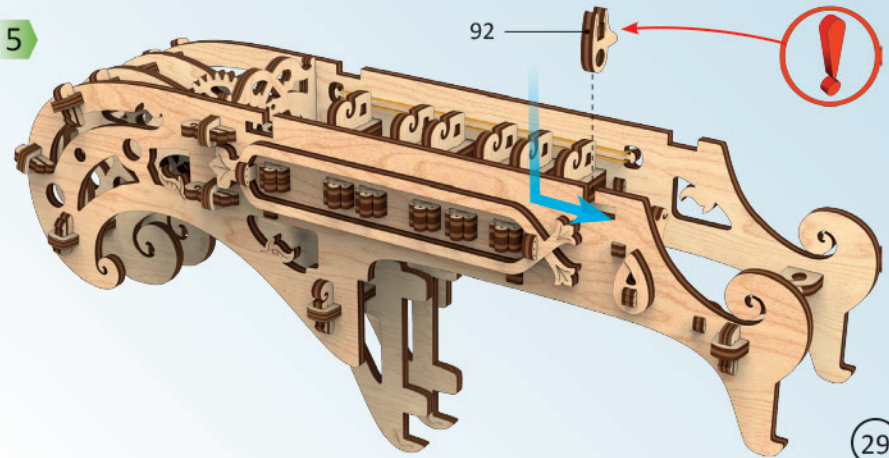



4

1

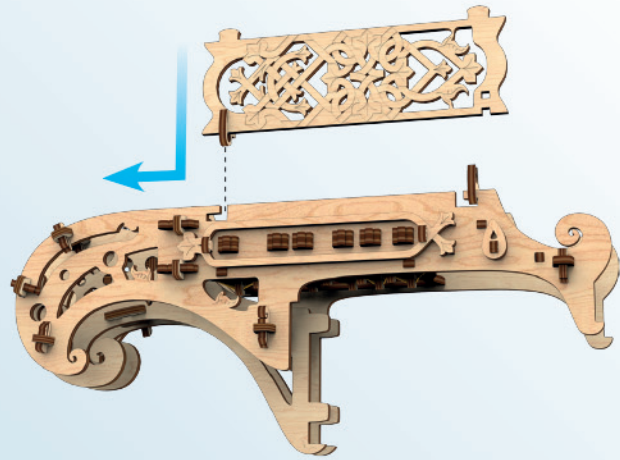

2

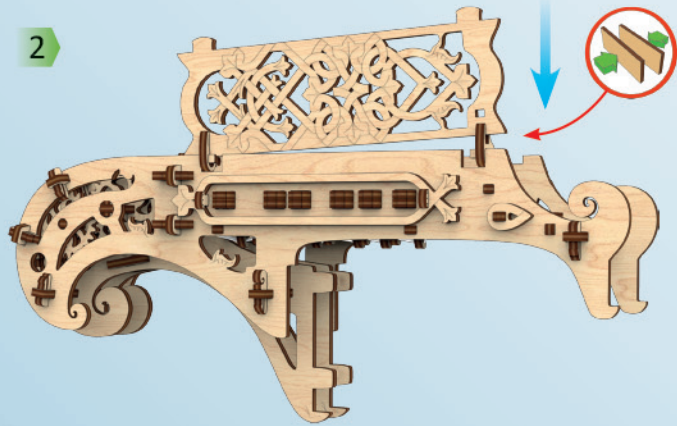

3

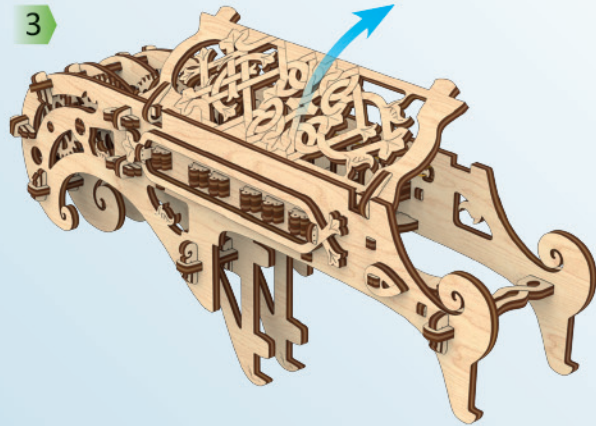

1

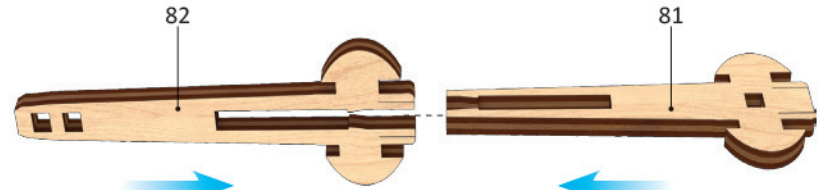

2

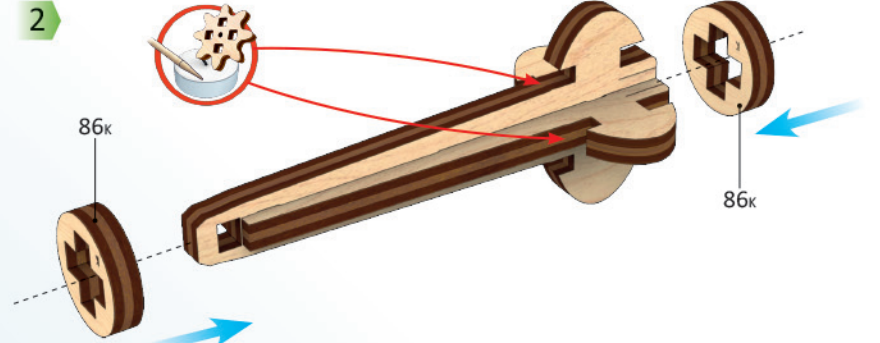

3

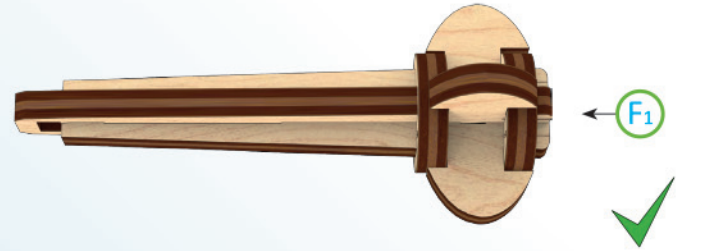



4



5

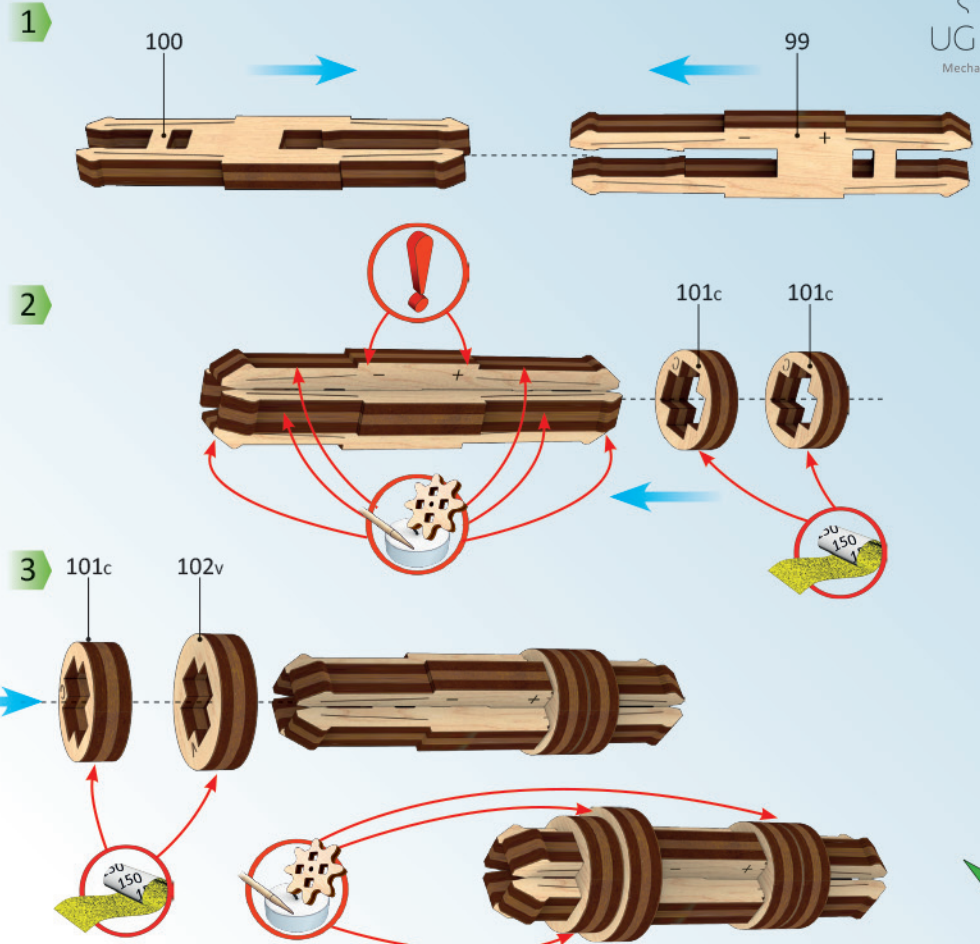
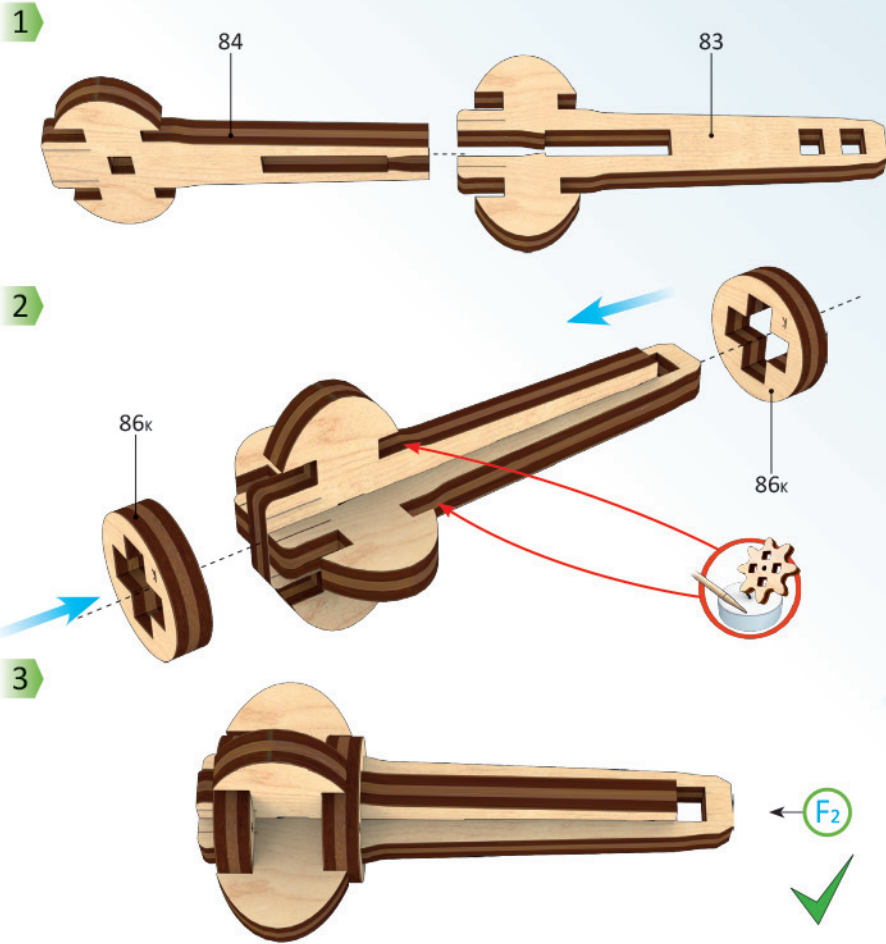

Mechanical models

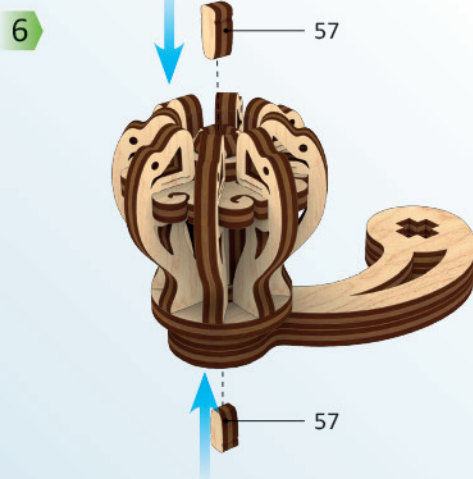
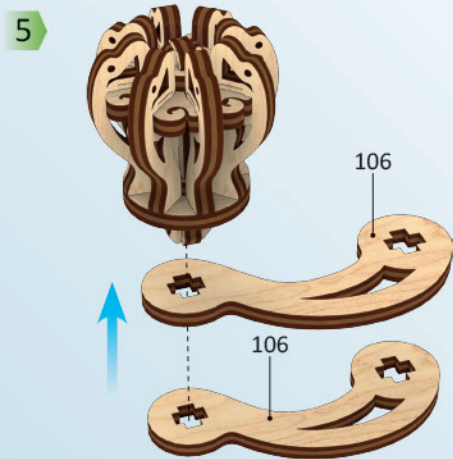
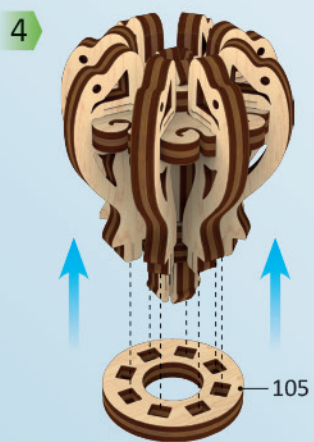
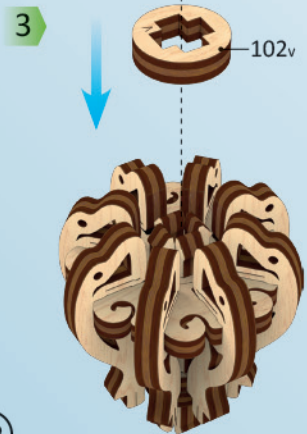
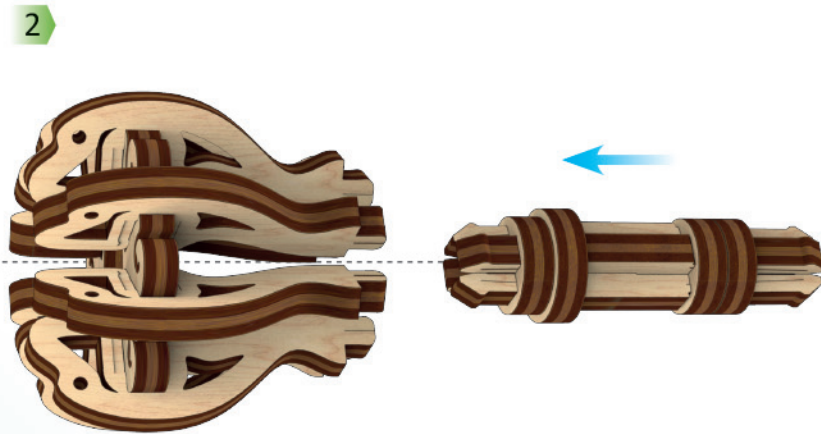
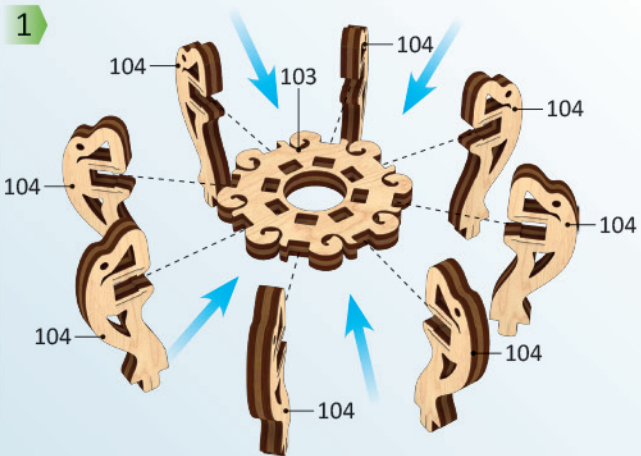
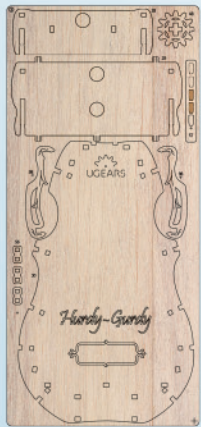

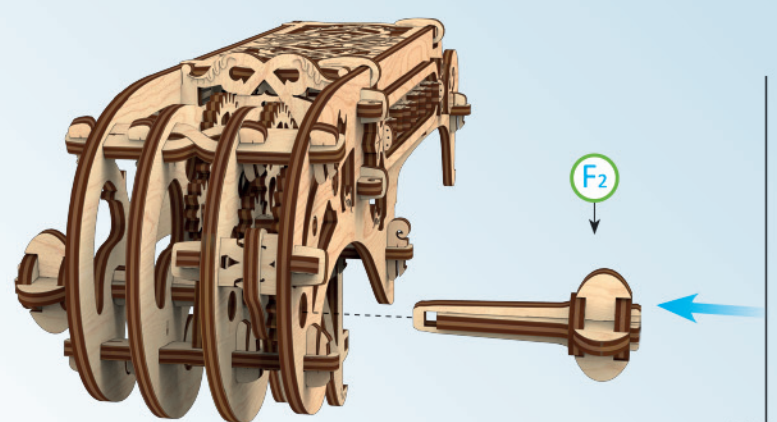
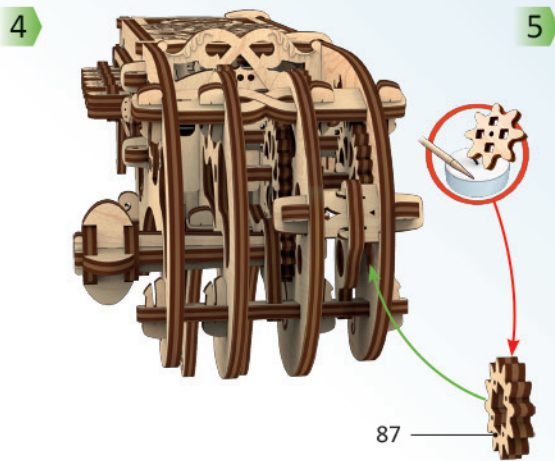
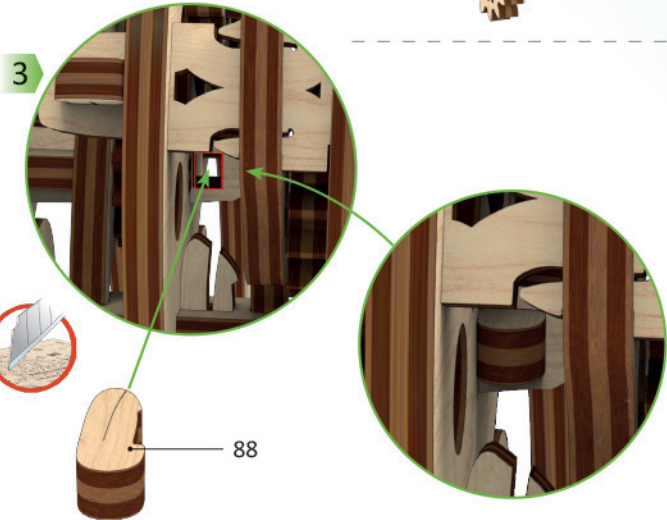
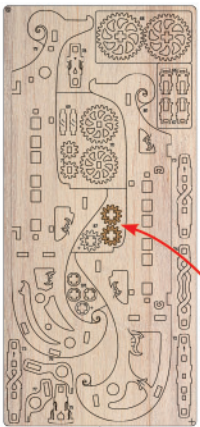
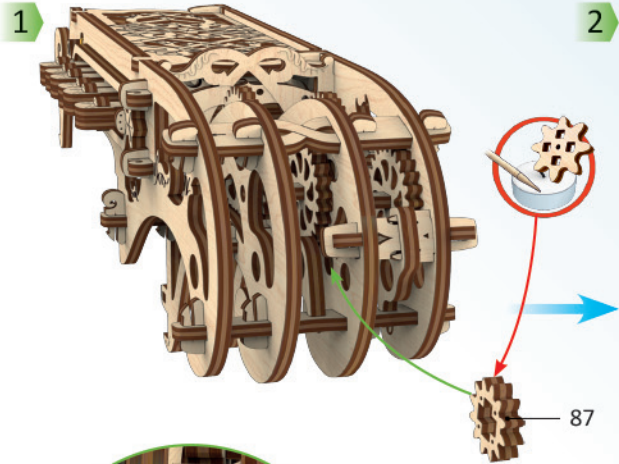
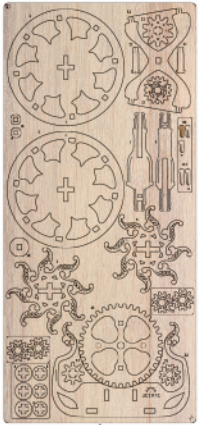

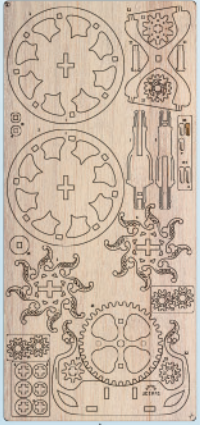

1

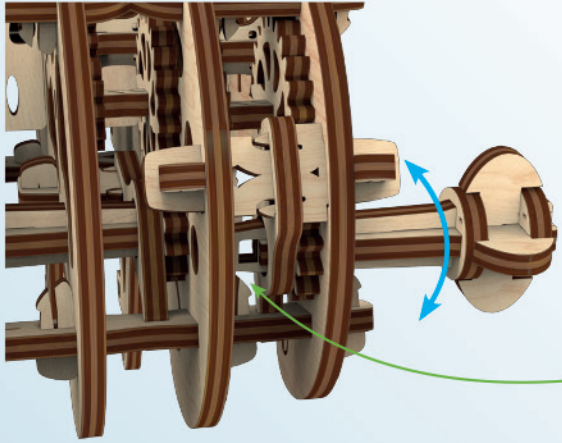

2

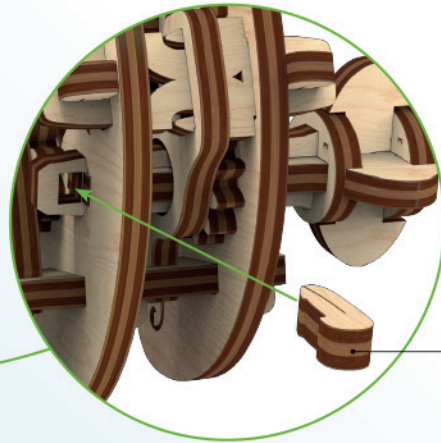

88

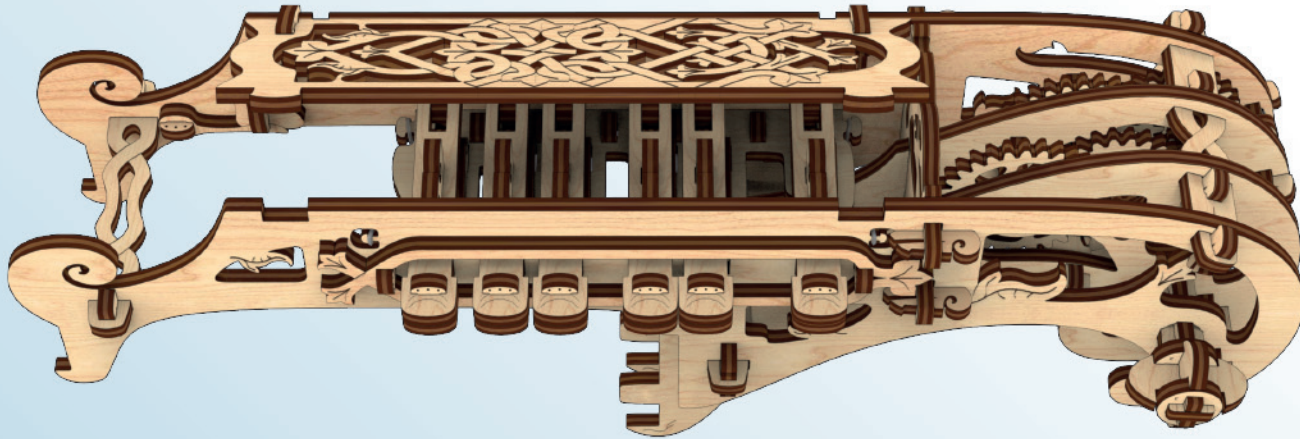

H

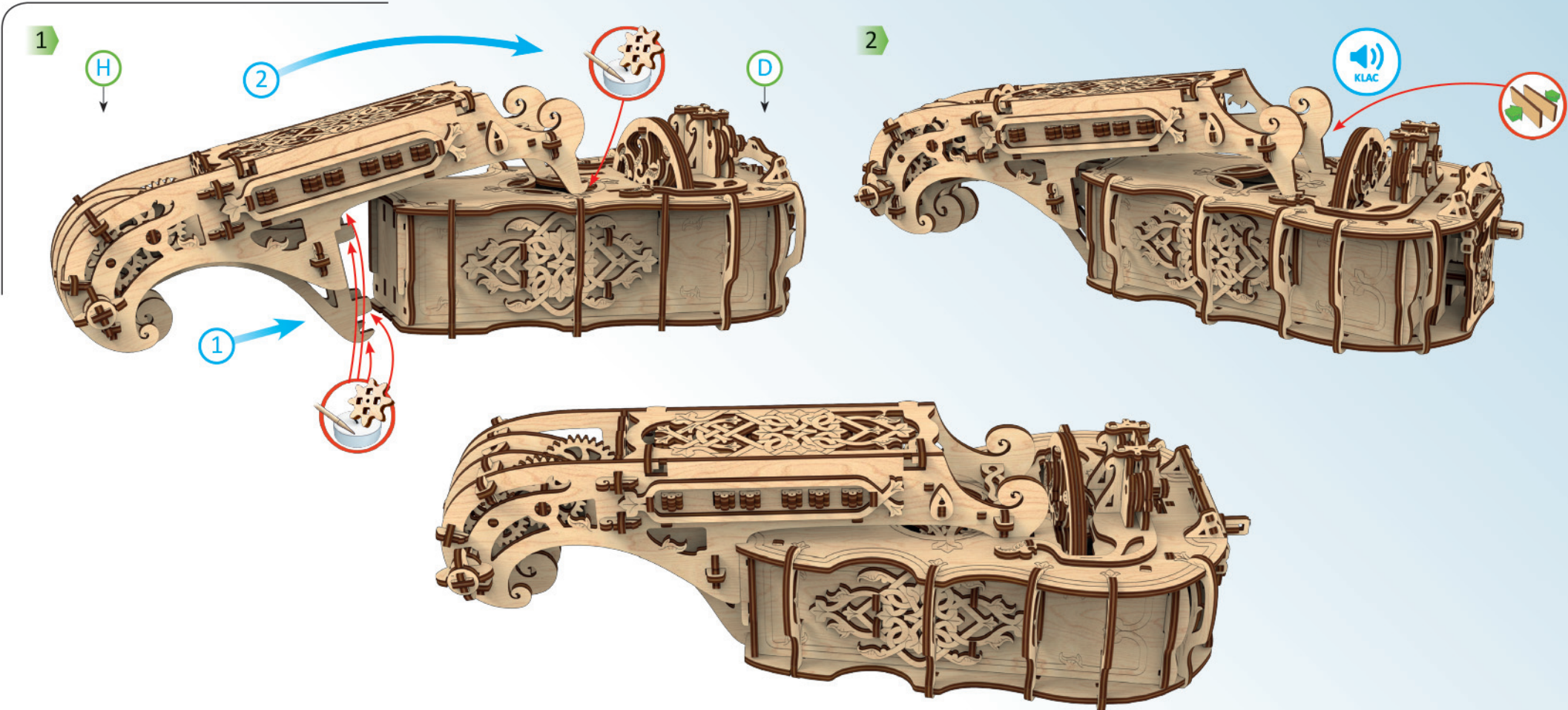

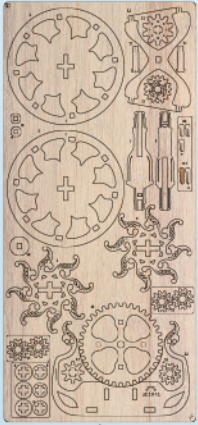

1

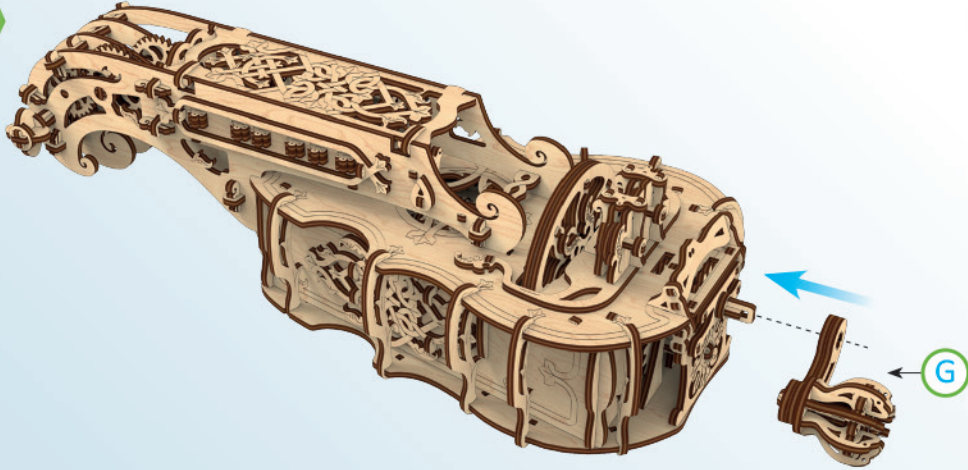

G

2

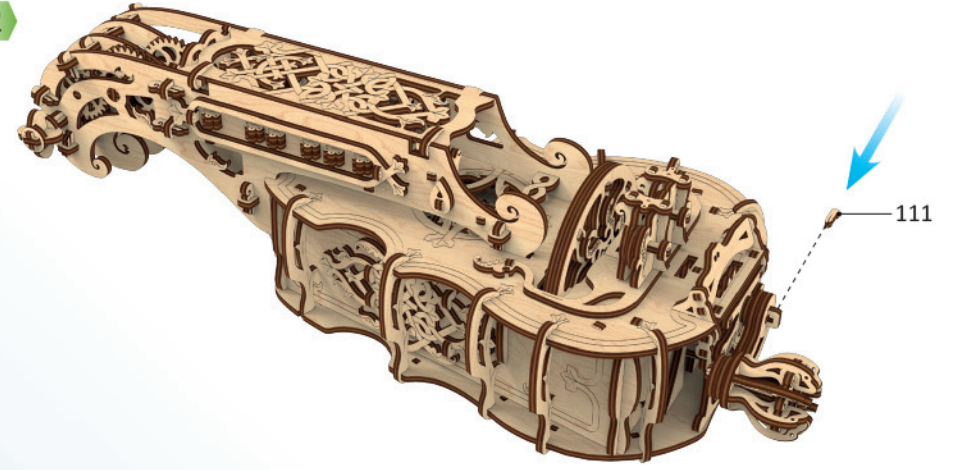

111

3

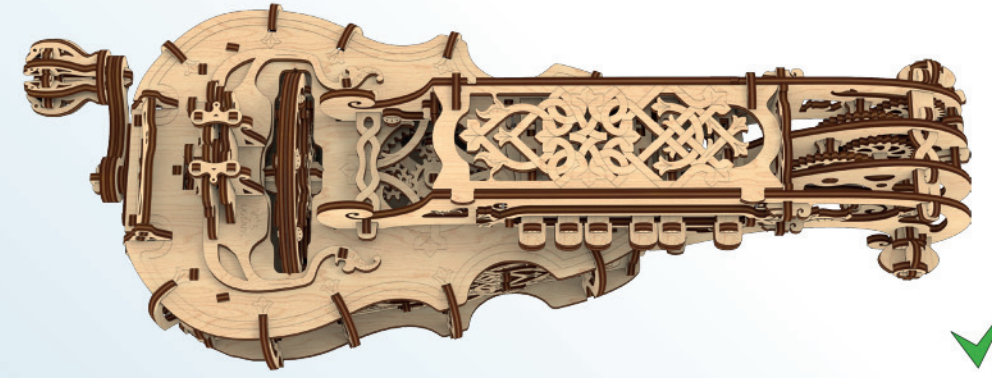
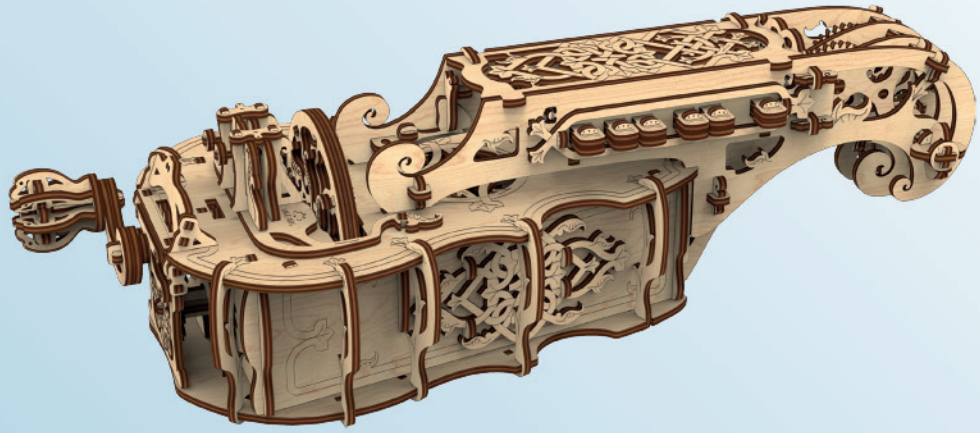

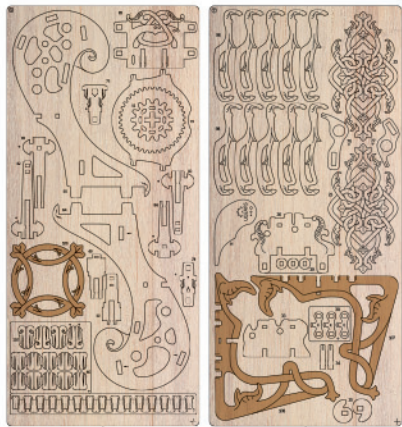

6

7



1

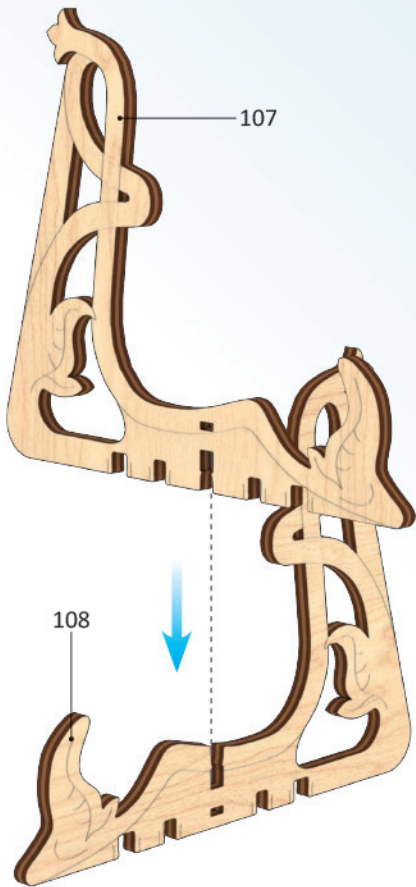

107

108

2

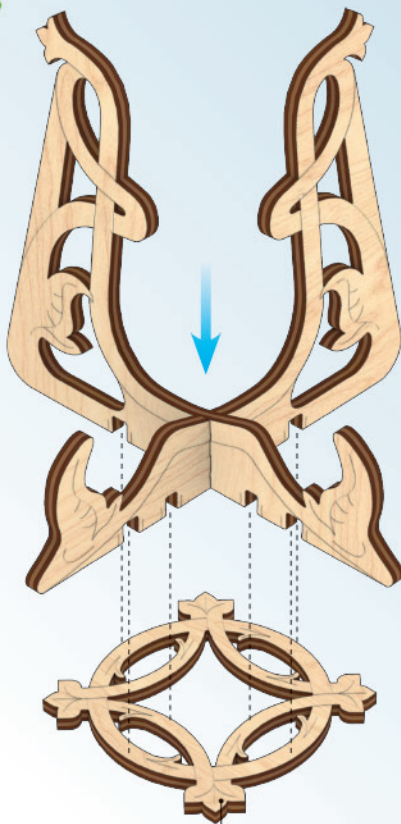

109

3

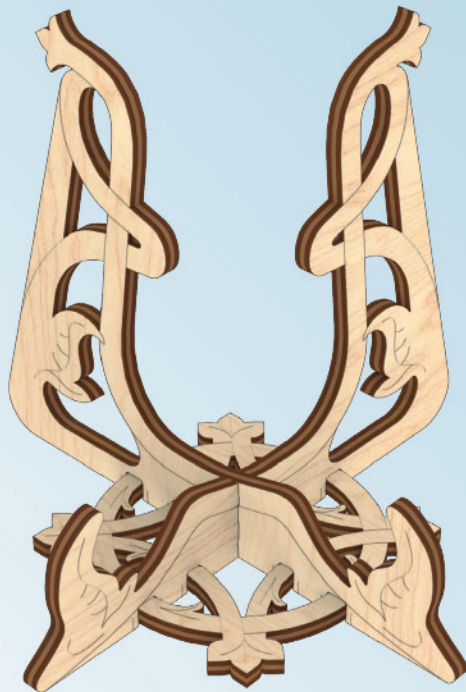

1

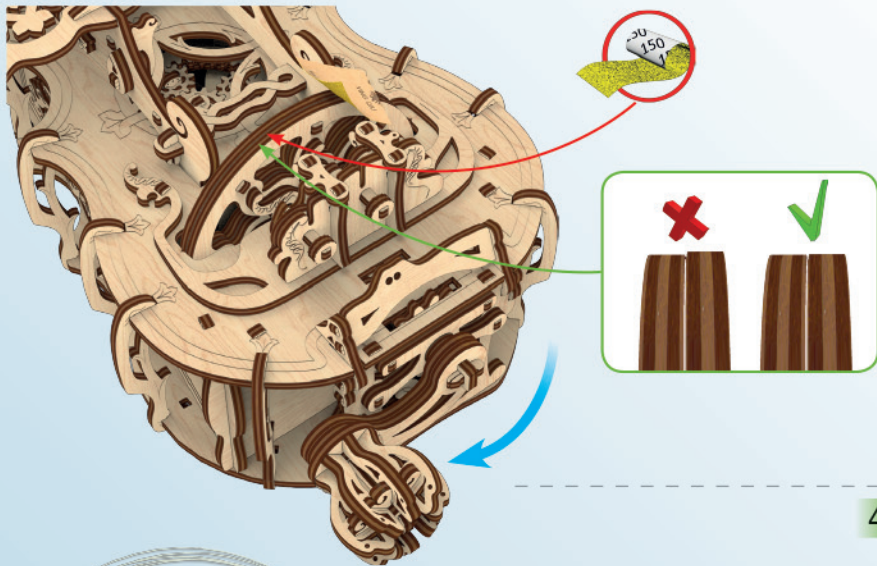

3

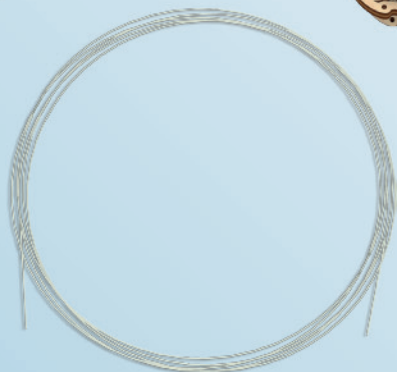

ENG Use the fishing line supplied. UKR Використовуйте ліску з комплекту. DEU Nutzen Sie die Angelschnur aus dem Bausatz. FRA Utilisez le fil fourni dans le kit. POL Użyj żyłki z zestawu. SPA Use el léxico de la unidad. ITA Usate la lenza dal kit. RUS Используйте леску из комплекта. JAP 同梱の弦(釣り糸)をお使いください。KOR 키트에서 낚시 줄을 사용합니다. CHI 请使用提供的钓鱼线。

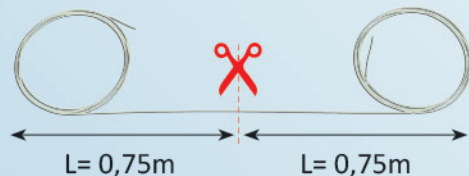

4

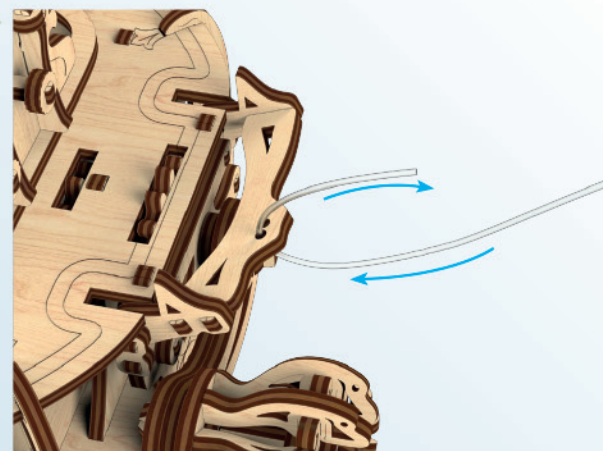

2

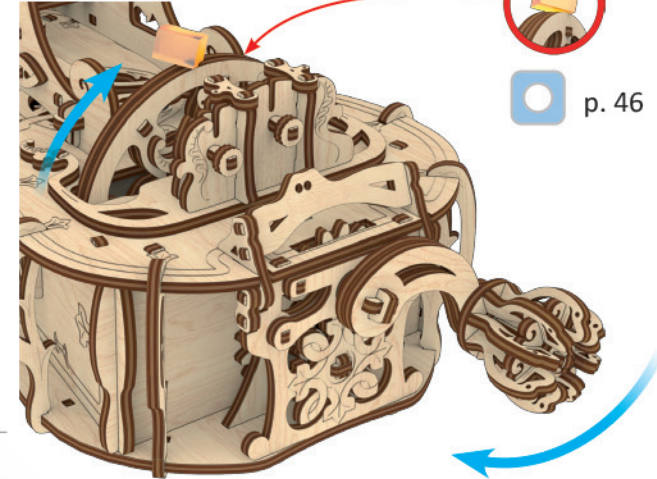

p. 46

ENG Attention! Do not confuse. Attention! The set includes rosin - it is used to increase the friction of the treated surface of the part! UKR Увага! Не переплутайте. У наборі є канифоль, для підвищення тертя поверхонь. DEU Achtung! Verwechslungsgefahr. Achtung! Kolophonium im Lieferumfang - wird dazu verwendet die Reibung der damit behandelten Oberflächen zu erhöhen. FRA Attention! Ne pas confondre. Attention! Dans la boîte est inclus de la résine (colophane) - utilisée pour augmenter le frottement de la surface traitée! POL Uwaga: Nie pomył się! Uwaga: Zestaw zawiera kalafonię, używaną do zwiększenia tarcia na powierzchni elementu. SPA ¡Atención! No se debe confundir. ¡Atención! El paquete incluye la colofonia - se utiliza para aumentar la fricción de la superficie tratada de la pieza! ITA Attenzione! Non confondere. Attenzione! Il set include colofonia - da utilizzare per aumentare l'attrito della superficie trattata! RUS Внимание! Не перепутайте. В комплект входит канифоль, для увеличения поверхностного трения. JAP 注意！混乱しないでください。注意！セットにはロジンが同梱されています。部品の表面にかかる摩擦力を和らげる時にお使いください。KOR 주의! 혼동하지 말 것. 주의! 세트안에 부품 표면의 마찰력을 높이기 위한 송진가루가 포함되어 있음. CHI 注意！不要混淆。注意！该组合包含松香-它用来提高处理过的部件表面的摩擦！

1

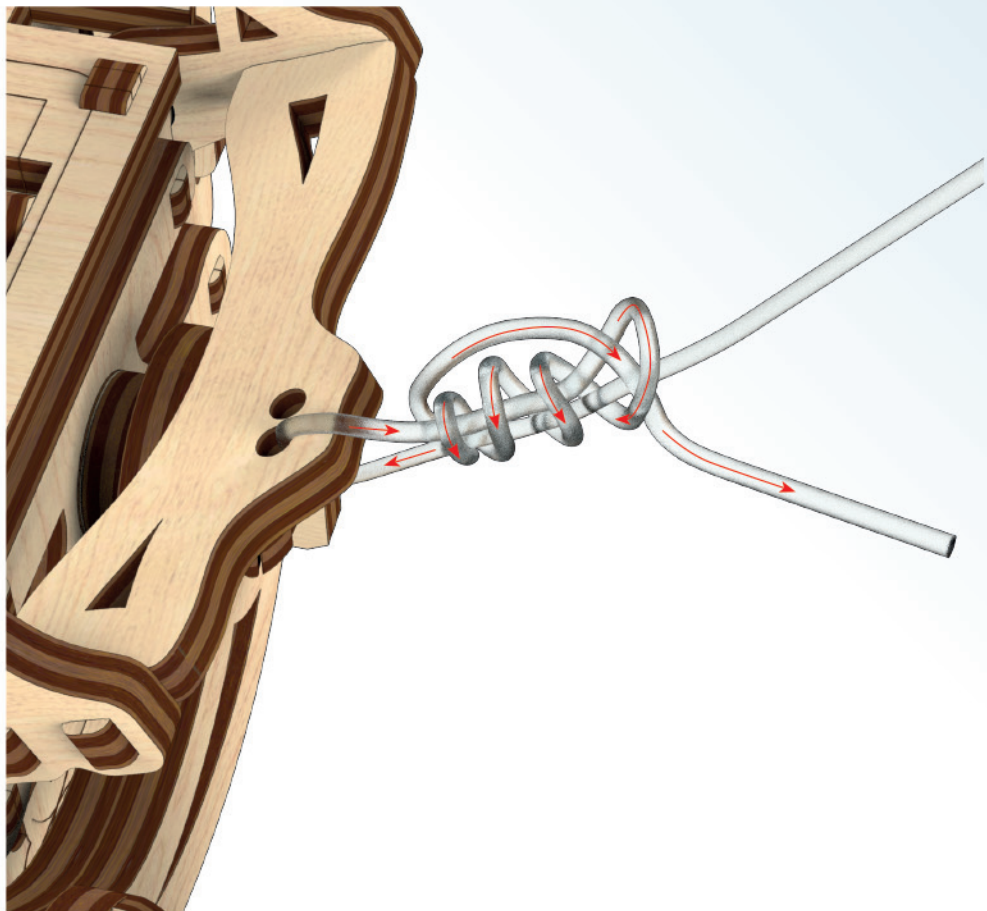

2

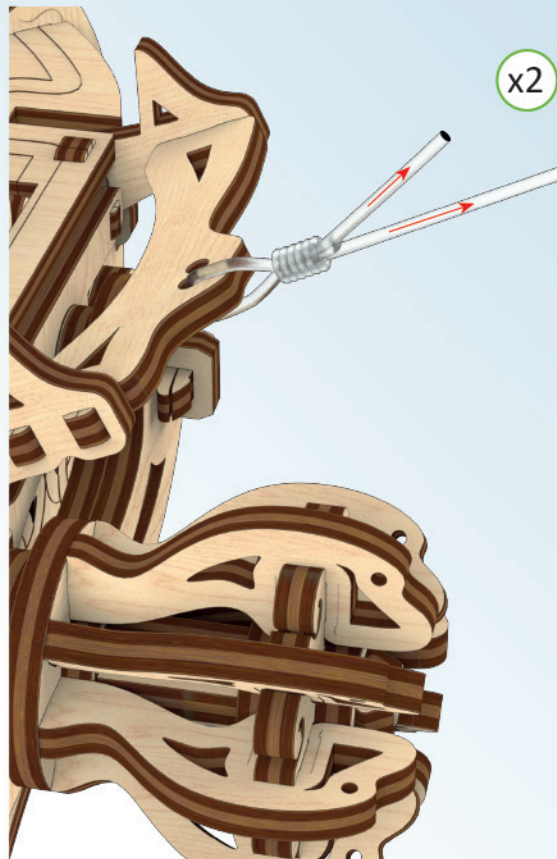

3

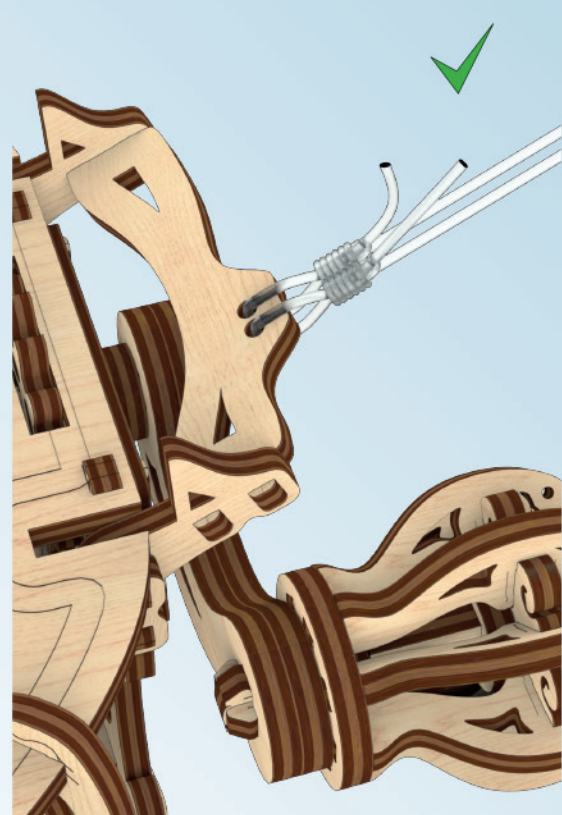

1

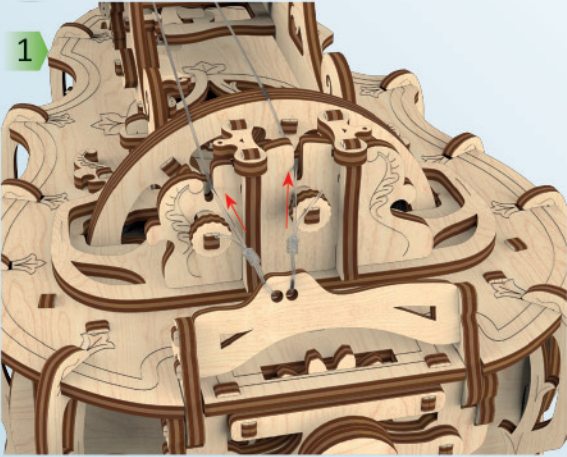

2



3

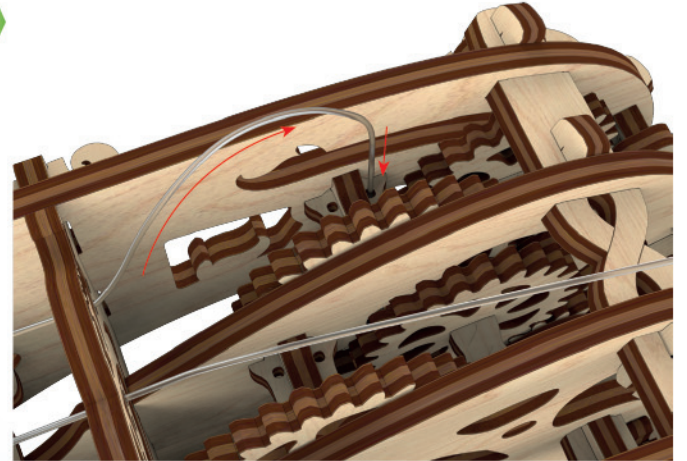

4

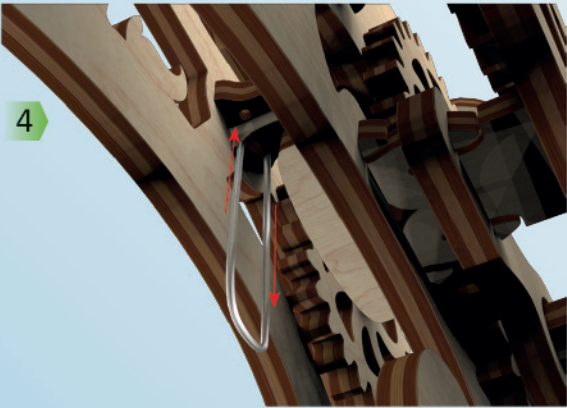

5

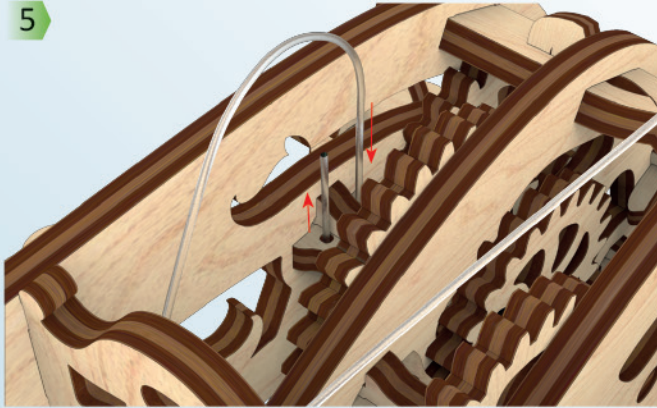

6

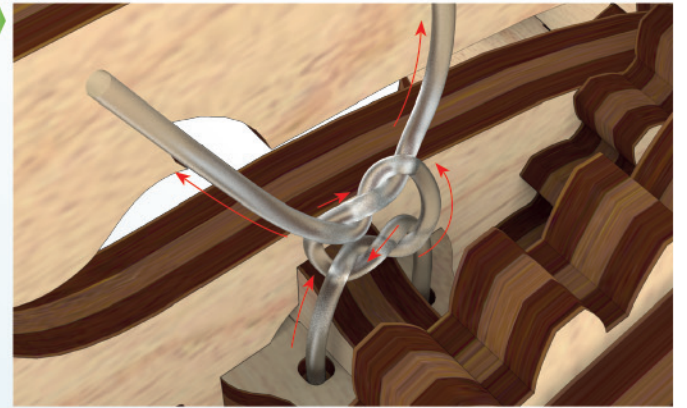

7

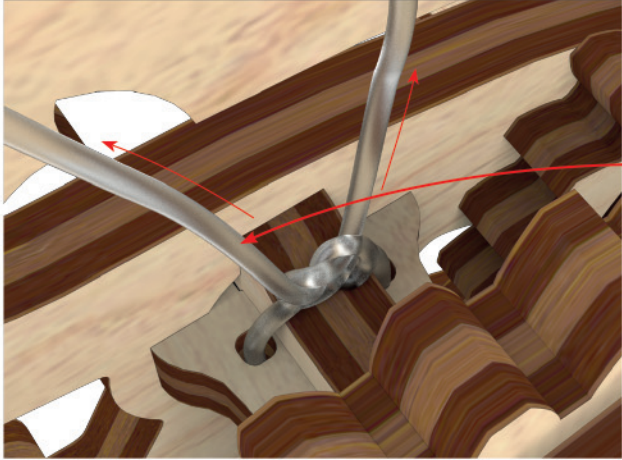

8



9

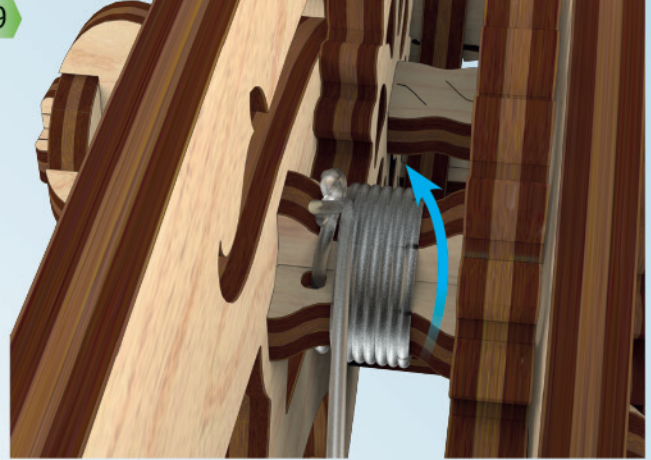

10

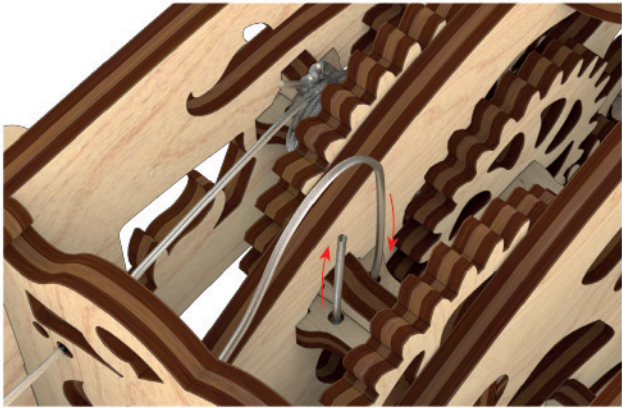

11

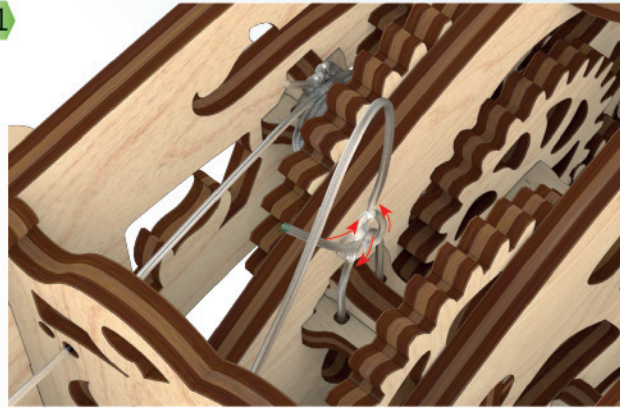

12





www.ugearsmodels.com/hurdy-gurdy

13

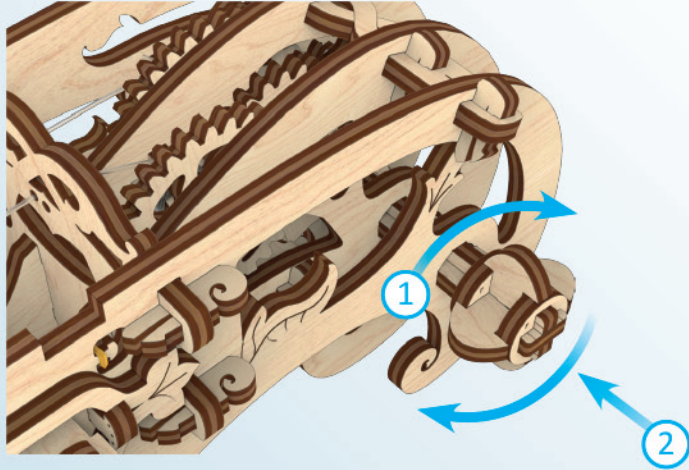

14

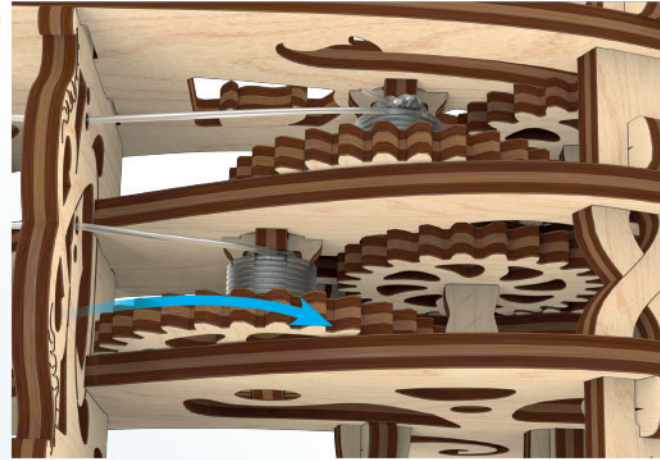

15

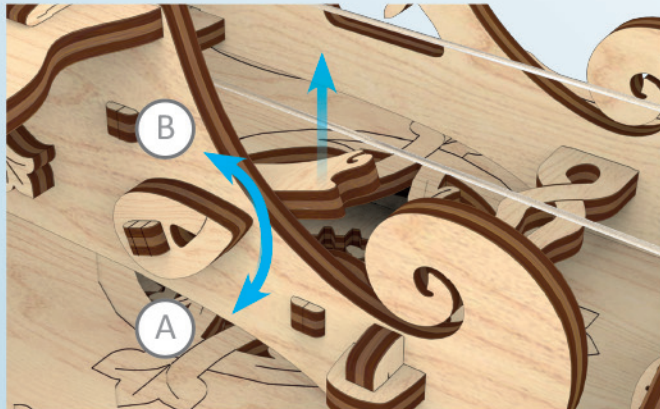

16

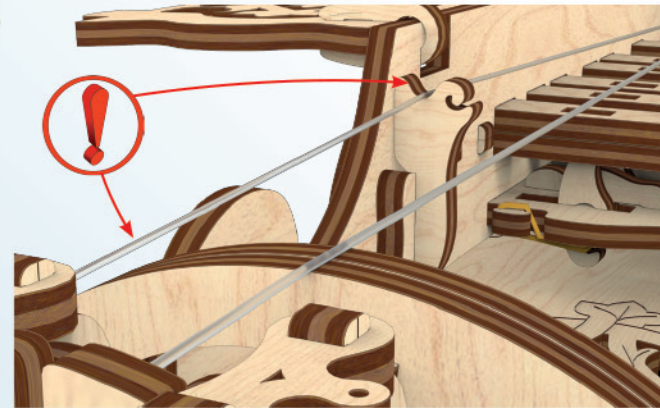

1

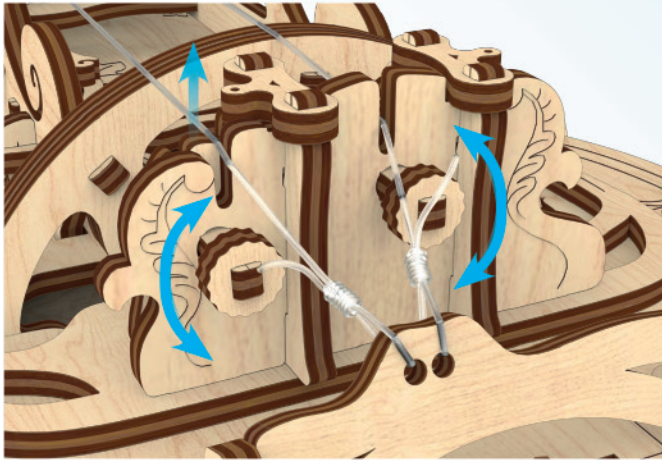

www.ugearsmodels.com/hurdy-gurdy

2

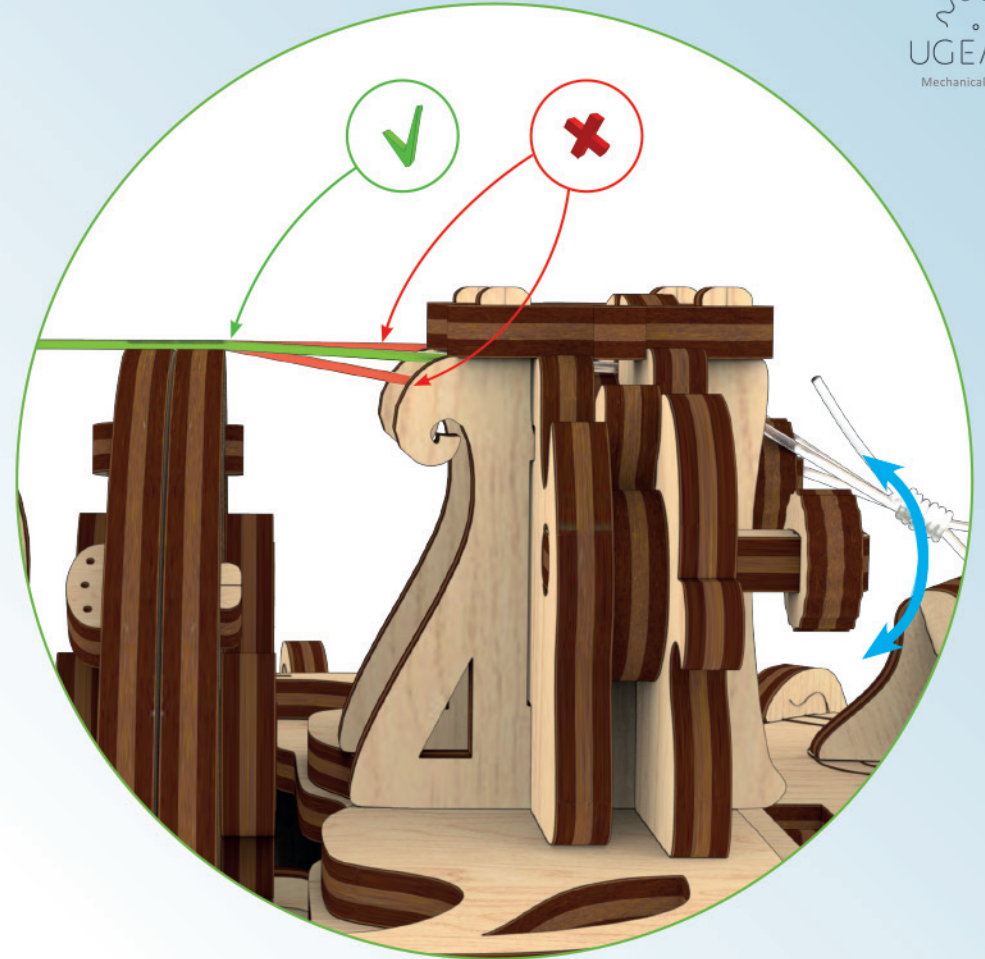
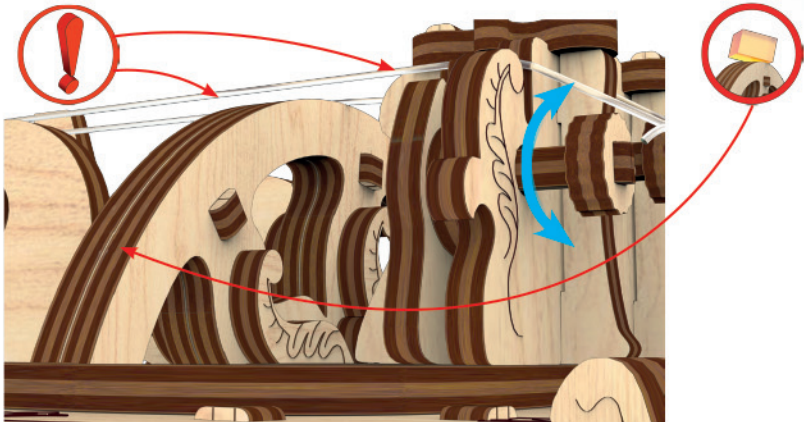

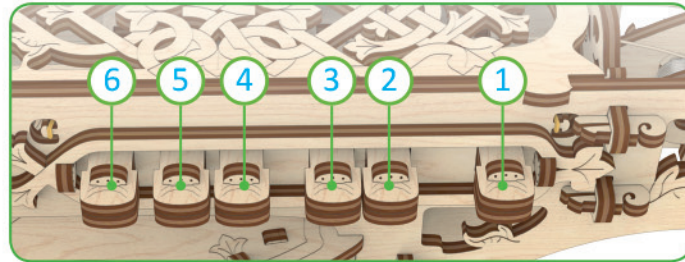
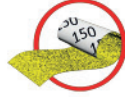

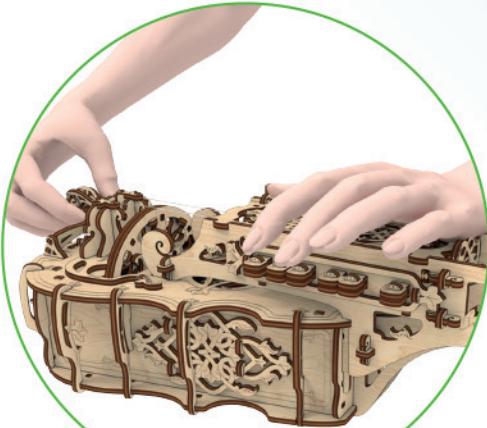

0

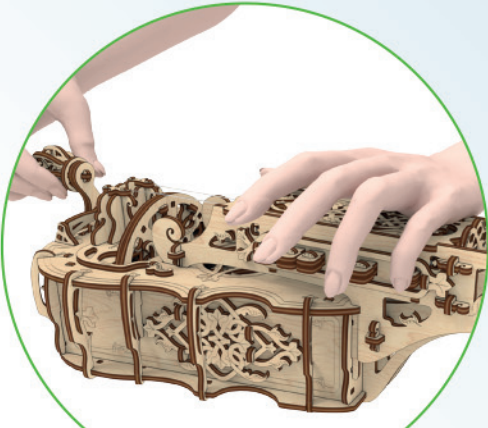

1

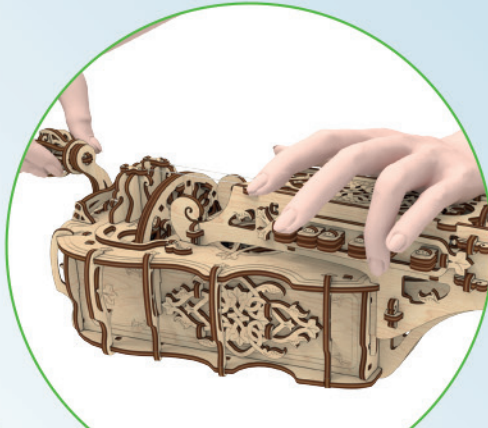

2

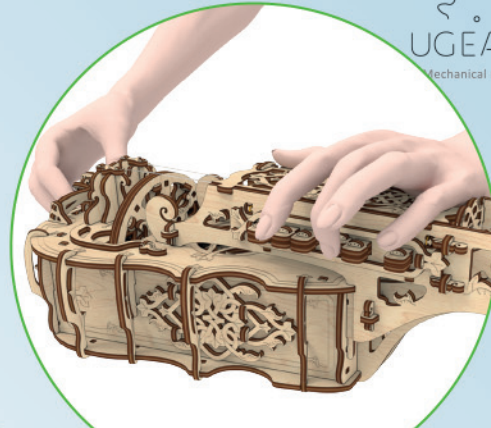

3



4

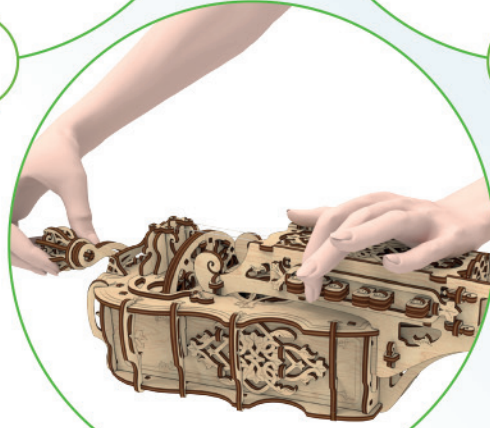

5

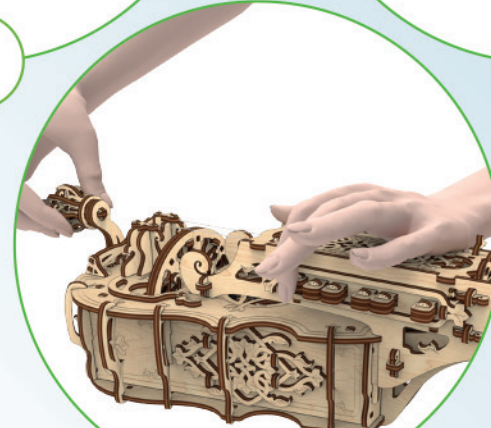

6



www.ugearsmodels.com/hurdy-gurdy

Ode to Joy

Musical notation for the first line of 'Ode to Joy'. It consists of 24 notes with fingerings indicated below them. The notes are: 2, 2, 3, 4, 4, 3, 2, 1, 0, 0, 1, 2, 2, 1, 2, 2, 3, 4, 4, 3, 2, 1, 0, 0, 1, 2, 1, 0. The notation ends with a double bar line and repeat dots.

Branle des Sabots

Musical notation for the first line of 'Branle des Sabots'. It consists of 18 notes with fingerings indicated below them. The notes are: 3, 3, 4, 3, 2, 1, 2, 0, 1, 1, 0, 3, 3, 2, 3, 4, 3, 2, 1, 2, 0. The notation uses beams to connect notes in groups.

Musical notation for the second line of 'Branle des Sabots'. It consists of 10 notes with fingerings indicated below them. The notes are: 4, 3, 2, 1, 2, 0, 1, 1, 1, 1. The notation uses beams to connect notes in groups and ends with a double bar line and repeat dots.

Medieval Rock'n'Roll

5 4 3 2 3 3 5 5 4 3 | 5 4 3 2 4 4 2 0 | 5 4 3 2 3 3 5 5 4 3 |

5 4 3 2 3 3 1 3 3 2 3 | 4 3 5 3 6 6 5 4 | 5 5 4 3 4 4 3 0 |

4 3 5 3 6 6 5 4 | 1 3 3 2 3 | 5 5 4 3 4 4 3 0 :||

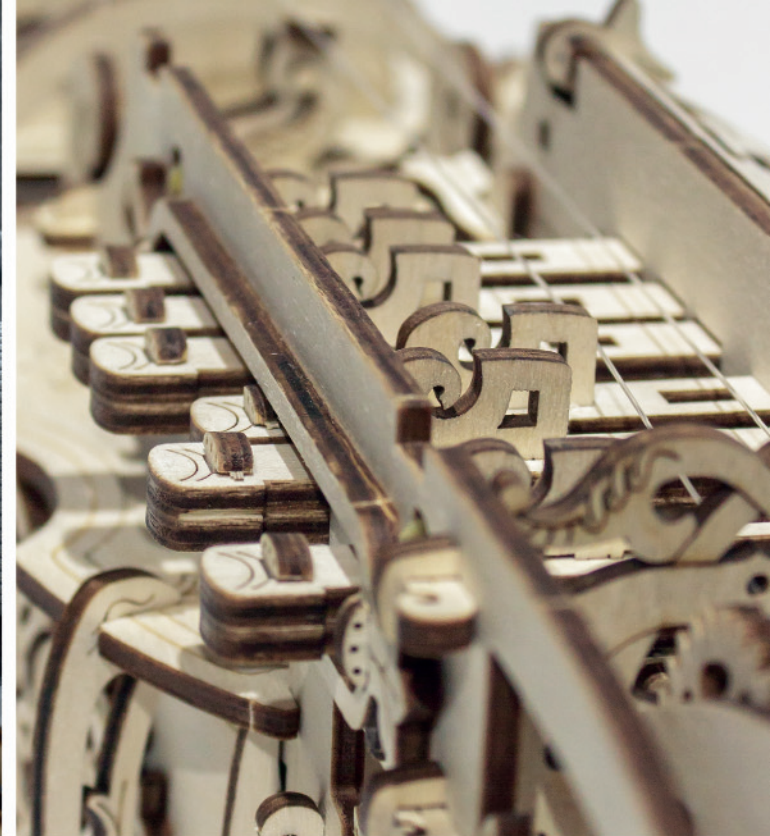

ENG Thanks for following along on this journey with us. **UKR** Дякуємо, що ви пройшли цей шлях з нами. **DEU** Vielen Dank, dass Sie diesen Weg mit uns gegangen sind. **FRA** Merci denous avoir accompagnés tout au long de ces étapes. **POL** Dziękujemy, że razem z nami pokonałeś tę drogę! **SPA** Gracias por haber recorrido el camino con nosotros. **ITA** Grazie per aver fatto uesto percorso con noi. **RUS** Спасибо, что вы прошли этот путь с нами. **JAP** UGEARSをご利用いただきありがとうございます。 **KOR** UGEARS 와 함께해 주셔서 감사합니다. **CHI** 感谢您参与有趣的模型拼装过程。

ENG Customer support **UKR** Служба підтримки **DEU** Kundendienst **FRA** Service client **POL** Wsparcie klienta
SPA Servicio al cliente **ITA** Servizio di supporto **RUS** Служба поддержки **JAP** お客様窓口 **KOR** 고객센터 **CHI** 客户支持

ugearsmodels.com

customerservice@ugearsmodels.com