

TRX4

Scale and Trail[™]
Crawler

MODEL 82056-4



TRAXAS

OWNER'S MANUAL

INTRODUCTION

- 3 BEFORE YOU PROCEED
- 4 SAFETY PRECAUTIONS
- 7 TOOLS, SUPPLIES, AND REQUIRED EQUIPMENT
- 8 ANATOMY OF THE TRX-4
- 10 QUICK START: GETTING UP TO SPEED
- 11 TRAXXAS TQi RADIO SYSTEM
- 18 ADJUSTING THE ELECTRONIC SPEED CONTROL
- 21 DRIVING YOUR MODEL
- 25 TUNING ADJUSTMENTS
- 30 MAINTAINING YOUR MODEL
- 31 TQi ADVANCED TUNING GUIDE

Thank you for purchasing the all-new Traxxas TRX-4 Scale and Trail Crawler. The design of the TRX-4 instantly obsoletes the status quo with greatly expanded features and versatility. The TRX-4 features the powerful Titan® 21T 550 motor, waterproof electronics, and a smooth XL-5 HV 3s LiPo-capable electronic speed control. The game-changing portal axles provide greater ground clearance while the rigid steel frame eliminates chassis flex and allows you to navigate tough terrain. The new Canyon Trail 1.9 tires feature tuned foam inserts to deliver superior bite on rocky surfaces with convincing scale realism. In other words, we built it the Traxxas way -- rugged, powerful, and ready to handle the rigors of remote locations and all-day driving fun!

This manual contains the instructions you will need to operate and maintain your model so that you can enjoy it for years to come. We want you to feel confident that you own one of the best-performing models in the market and that it is backed by a team of professionals who aim to provide the highest level of factory support possible. Traxxas models are about experiencing total performance and satisfaction, not just with your model, but also with the company that stands behind it.

We know you're excited about getting your new model on the trail, but it's very important that you take some time to read through the Owner's Manual. This manual contains all the necessary setup and operating procedures that allow you to unlock the performance and potential that Traxxas engineers designed into your model. **Even if you are an experienced R/C enthusiast, it's important to read and follow the procedures in this manual.**

Thank you again for going with Traxxas. We work hard every day to assure you the highest level of customer satisfaction possible. We truly want you to enjoy your new model!

FCC Compliance

This device contains a module that complies with the limits for a Class B digital device as described in part 15 of the FCC rules. Operation is subject to the following two conditions: (1) This device may not cause harmful interference, and (2) this device must accept any interference received, including interference that may cause undesired operation.

The limits for a Class B digital device are designed to provide reasonable protection against harmful interference in residential settings. This product generates, uses and can radiate radio frequency energy, and, if not operated in accordance with the instructions, may cause harmful interference to radio communications. The user is cautioned that changes or modifications not expressly approved by the party responsible for compliance could void the user's authority to operate the equipment.

Canada, Industry Canada (IC)

This Class B digital apparatus complies with Canadian ICES-003 and RSS-210. This device complies with Industry Canada license exempt RSS standard(s). Operation is subject to the following two conditions: This device may not cause interference, and This device must accept any interference, including interference that may cause undesired operation of the device.

Radio Frequency (RF) Exposure Statement

This equipment complies with radio frequency exposure limits set forth by FCC and Industry Canada for an uncontrolled environment. This equipment should be installed and operated with a minimum distance of 20 centimeters between the radiator and your body or bystanders and must not be co-located or operating in conjunction with any other antenna or transmitter.

Operation Frequency: 2414~2453 MHz

Maximum Radio Frequency Power: Maximum Peak Power 9.7 dBm

Traxxas Support

Traxxas support is with you every step of the way. Refer to the next page to find out how to contact us and what your support options are.



Quick Start

This manual is designed with a Quick Start path that outlines the necessary procedures to get your model up and running in the shortest time possible. If you are an experienced R/C enthusiast, you will find it helpful and fast. Be sure and read through the rest of the manual to learn about important safety, maintenance, and adjustment procedures. Turn to page 10 to begin.



REGISTERING YOUR MODEL

In order to serve you better as our customer, please register your product within 10 days of your purchase online at [Traxxas.com/register](https://www.traxxas.com/register).

[Traxxas.com/register](https://www.traxxas.com/register)

BEFORE YOU PROCEED

Carefully read and follow all instructions in this and any accompanying materials to prevent serious damage to your model. Failure to follow these instructions will be considered abuse and/or neglect.

Before running your model, look over this entire manual and examine the model carefully. If for some reason you decide it is not what you wanted, then do not continue any further. **Your hobby dealer absolutely cannot accept a model for return or exchange after it has been run.**

Warnings, Helpful Hints, & Cross-References

Throughout this manual, you'll notice warnings and helpful hints identified by the icons below. Be sure to read them!



An important warning about personal safety or avoiding damage to your model and related components.



Special advice from Traxxas to make things easier and more fun.



Refers you to a page with a related topic.

SUPPORT

If you have any questions about your model or its operation, call the Traxxas Technical Support Line toll-free at: **1-888-TRAXXAS (1-888-872-9927)***

Technical support is available Monday through Friday from 8:30am to 9:00pm central time. Technical assistance is also available at Traxxas.com. You may also e-mail customer support with your question at support@Traxxas.com. Join thousands of registered members in our online community at Traxxas.com.

Traxxas offers a full-service, on-site repair facility to handle any of your Traxxas service needs. Maintenance and replacement parts may be purchased directly from Traxxas by phone or online at Traxxas.com. You can save time, along with shipping and handling costs, by purchasing replacement parts from your local dealer.

Do not hesitate to contact us with any of your product support needs. We want you to be thoroughly satisfied with your new model!

Traxxas
6250 Traxxas Way
McKinney, Texas 75070
Phone: 972-549-3000
Toll-free 1-888-TRAXXAS

Internet
Traxxas.com
E-mail: support@Traxxas.com

Entire contents ©2020 Traxxas. All rights reserved. Traxxas, Ready-To-Drive, TQi, Titan, TRX-4, and XL-5 HV are trademarks or registered trademarks of Traxxas. Other brand names and marks are the property of their respective holders and are used only for purposes of identification. No part of this manual may be reproduced or distributed in print or electronic media without the express written permission of Traxxas. Specifications are subject to change without notice.

Land Rover and the Land Rover Logo are trademarks owned and licensed by Jaguar Land Rover Limited.

Officially Licensed Product.
Land Rover Trademarks used under license to Traxxas, LP.

*Toll-free support is available to U.S. residents only.

SAFETY PRECAUTIONS



All instructions and precautions outlined in this manual should be strictly followed to ensure safe operation of your model.



This model is not intended for use by children under 14 years of age without the supervision of a responsible and knowledgeable adult.



No previous experience with radio controlled models is required. Models require a minimum of setup, maintenance, or support equipment.

All of us at Traxxas want you to safely enjoy your new model. Operate your model sensibly and with care, and it will be exciting, safe, and fun for you and those around you. Failure to operate your model in a safe and responsible manner may result in property damage and serious injury. The precautions outlined in this manual should be strictly followed to help ensure safe operation. You alone must see that the instructions are followed and the precautions are adhered to.

Important Points to Remember

- Your model is not intended for use on public roads or congested areas where its operation can conflict with or disrupt pedestrian or vehicular traffic.
- Never, under any circumstances, operate the model in crowds of people. Your model could cause injury if allowed to collide with anyone.
- Because your model is controlled by radio, it is subject to radio interference from many sources that are beyond your control. Since radio interference can cause momentary losses of radio control, always allow a safety margin in all directions around the model in order to prevent collisions.
- The motor, battery, and speed control can become hot during use. Be careful to avoid getting burned.
- Don't operate your model at night, or anytime your line of sight to the model may be obstructed or impaired in any way.
- **Most importantly, use good common sense at all times.**

Speed Control

Your model's electronic speed control (ESC) is an extremely powerful electronic device capable of delivering high current. Please closely follow these precautions to prevent damage to the speed control or other components.

- **Disconnect the Battery:** Always disconnect the battery from the speed control when not in use.

- **Insulate the Wires:** Always insulate exposed wiring with heat shrink tubing to prevent short circuits.
- **6-7 NiMH cells or 2-3 LiPo cells (2s/3s):** The XL-5 HV can accept a maximum input voltage of 8.4 volts (NiMH) or 11.1 volts (3s LiPo). Always adhere to the minimum and maximum limitations of the XL-5 HV as stated in the specifications table.
- **Transmitter on First:** Switch on your transmitter first before switching on the speed control to prevent runaways and erratic performance.
- **Don't Get Burned:** The ESC and motor can become extremely hot during use, so be careful not to touch them until they cool. Supply adequate airflow for cooling.
- **Use the Factory-Installed Connectors:** Do not change the battery and motor connectors. Improper wiring can cause fire or damage to the ESC. Please note that modified speed controls can be subject to a rewiring fee when returned for service.
- **No Reverse Voltage:** The ESC is not protected against reverse polarity voltage.
- **No Schottky Diodes:** External Schottky diodes are not compatible with reversing speed controls. Using a Schottky diode with your Traxxas speed control will damage the ESC and void the 30-day warranty.

Recycling Traxxas Power Cell NiMH Batteries

Traxxas strongly encourages you to recycle Power Cell NiMH batteries when they reach the end of their useful life. Do not throw batteries in the trash. All Power Cell NiMH battery packs display the RBRC (Rechargeable Battery Recycling Corporation) icon, indicating they are recyclable. To find a recycling center near you, ask your local hobby dealer or visit www.call2recycle.org.





WARNING! CAUTION! DANGER!

FIRE HAZARD! Your model is able to use LiPo batteries. Charging and discharging batteries has the potential for fire, explosion, serious injury, and property damage if not performed per the instructions. Before use, read and follow all manufacturer's instructions, warnings, and precautions. In addition, Lithium Polymer (LiPo) batteries pose a SEVERE risk of fire if not properly handled per the instructions and require special care and handling procedures for long life and safe operation. LiPo batteries are intended only for advanced users that are educated on the risks associated with LiPo battery use. Traxxas does not recommend that anyone under the age of 14 use or handle LiPo battery packs without the supervision of a knowledgeable and responsible adult. Dispose of used batteries according to the instructions.

Important Warnings for users of Lithium Polymer (LiPo) batteries:

- LiPo batteries have a minimum safe discharge voltage threshold that should not be exceeded. The electronic speed control is equipped with built-in Low-Voltage Detection that alerts the driver when LiPo batteries have reached their minimum voltage (discharge) threshold. It is the driver's responsibility to stop immediately to prevent the battery pack from being discharged below its safe minimum threshold.
- Low-Voltage Detection is just one part of a comprehensive plan for safe LiPo battery use. It is critical to follow all instructions for safe and proper charging, use, and storage of LiPo batteries. Make sure you understand how to use your LiPo batteries. If you have questions about LiPo battery usage, please consult with your local hobby dealer or contact the battery manufacturer. As a reminder, all batteries should be recycled at the end of their useful life.
- ONLY use a Lithium Polymer (LiPo) balance charger with a balance adapter port to charge LiPo batteries. Never use NiMH or NiCad-type chargers or charge modes to charge LiPo batteries. DO NOT charge with a NiMH-only charger. The use of a NiMH or NiCad charger or charge mode will damage the batteries and may cause fire and personal injury.
- NEVER charge LiPo battery packs in series or parallel. Charging packs in series or parallel may result in improper charger cell recognition and an improper charging rate that may lead to overcharging, cell imbalance, cell damage, and fire.



- ALWAYS inspect your LiPo batteries carefully before charging. Look for any loose leads or connectors, damaged wire insulation, damaged cell packaging, impact damage, fluid leaks, swelling (a sign of internal damage), cell deformity, missing labels, or any other damage or irregularity. If any of these conditions are observed, do not charge or use the battery pack. Follow the disposal instructions included with your battery to properly and safely dispose of the battery.
- DO NOT store or charge LiPo batteries with or around other batteries or battery packs of any type, including other LiPos.
- Store and transport your battery pack(s) in a cool dry place. DO NOT store in direct sunlight. DO NOT allow the storage temperature to exceed 140°F or 60°C, such as in the trunk of a car, or the cells may be damaged and create a fire risk.
- DO NOT disassemble LiPo batteries or cells.
- DO NOT attempt to build your own LiPo battery pack from loose cells.

Charging and handling precautions for all battery types:

- BEFORE you charge, ALWAYS confirm that the charger settings exactly match the type (chemistry), specification, and configuration of the battery to be charged.
- DO NOT attempt to charge non-rechargeable batteries (explosion hazard), batteries that have an internal charge circuit or a protection circuit, batteries that have been altered from original manufacturer configuration, or batteries that have missing or unreadable labels, preventing you from properly identifying the battery type and specifications.
- DO NOT exceed the maximum manufacturer recommended charge rate.
- DO NOT let any exposed battery contacts or wires touch each other. This will cause the battery to short circuit and create the risk of fire.
- While charging or discharging, ALWAYS place the battery (all types of batteries) in a fire retardant/fire proof container and on a non-flammable surface such as concrete.
- DO NOT charge batteries inside of an automobile. DO NOT charge batteries while driving in an automobile.
- NEVER charge batteries on wood, cloth, carpet, or on any other flammable material.
- ALWAYS charge batteries in a well-ventilated area.

(continued on next page)

(continued from previous page)

- REMOVE flammable items and combustible materials from the charging area.
- DO NOT leave the charger and battery unattended while charging, discharging, or anytime the charger is ON with a battery connected. If there are any signs of a malfunction or in the event of an emergency, unplug the charger from the power source and disconnect the battery from the charger.
- DO NOT operate the charger in a cluttered space, or place objects on top of the charger or battery.
- If any battery or battery cell is damaged in any way, DO NOT charge, discharge, or use the battery.
- Keep a Class D fire extinguisher nearby in case of fire.
- DO NOT disassemble, crush, short circuit, or expose the batteries to flame or other source of ignition. Toxic materials could be released. If eye or skin contact occurs, flush with water.
- If a battery gets hot to the touch during the charging process (temperature greater than 110°F / 43°C), immediately disconnect the battery from the charger and discontinue charging.
- Allow the battery pack to cool off between runs (before charging).
- ALWAYS unplug the charger and disconnect the battery when not in use.
- ALWAYS unplug the battery from the electronic speed control when the model is not in use and when it is being stored or transported.
- DO NOT disassemble the charger.
- REMOVE the battery from your model or device before charging.
- DO NOT expose the charger to water or moisture.
- ALWAYS store battery packs safely out of the reach of children or pets. Children should always have adult supervision when charging and handling batteries.
- Nickel-Metal Hydride (NiMH) batteries must be recycled or disposed of properly.
- Always proceed with caution and use good common sense at all times.

TOOLS, SUPPLIES, AND REQUIRED EQUIPMENT

Your model comes with a set of specialty metric tools. You'll need to purchase other items, available from your hobby dealer, to operate and maintain your model.

Supplied Tools and Equipment

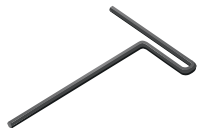

2.0mm "T" wrench



2.5mm "L" wrench



1.5mm "L" wrench



4-way wrench

Required Equipment (not included)



6 or 7-cell NiMH battery pack, or 2s/3s LiPo battery pack, with Traxxas High-Current connector*



Battery charger

Traxxas iD battery chargers are compatible with Traxxas High-Current Connectors



4 AA alkaline batteries



For more information on batteries, see *Use the Right Batteries* on page 13.



Recommended Equipment

These items are not required for the operation of your model, but are a good idea to include in any R/C toolbox:

- Safety glasses
- Traxxas Ultra Premium Tire Glue, Part #6468 (CA glue)
- Hobby knife
- Side cutters and/or needle nose pliers
- Phillips screwdriver
- Soldering iron

*Battery and charger style are subject to change and may vary from images.

ANATOMY OF THE TRX-4

Chassis Top View

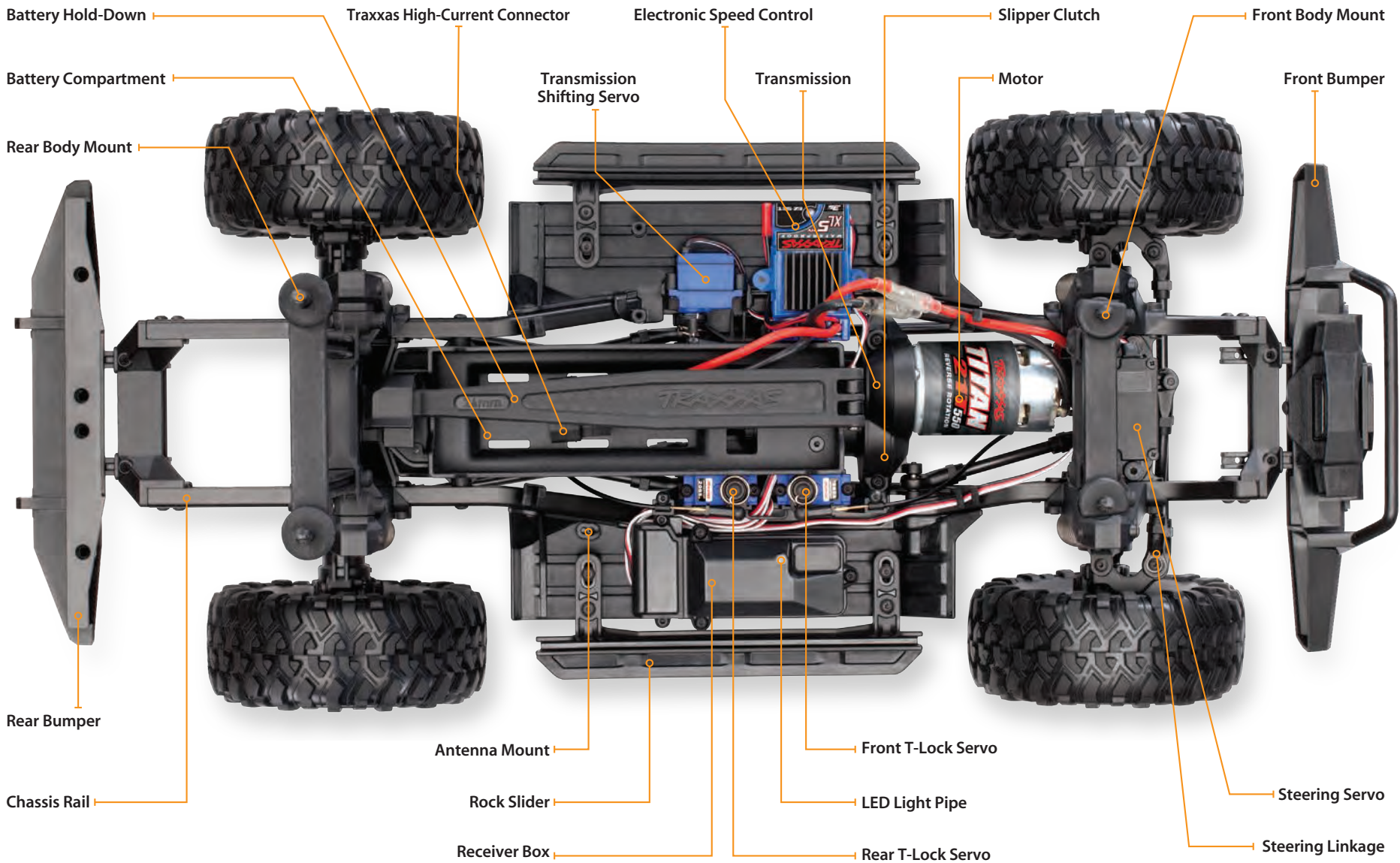

Chassis Bottom View

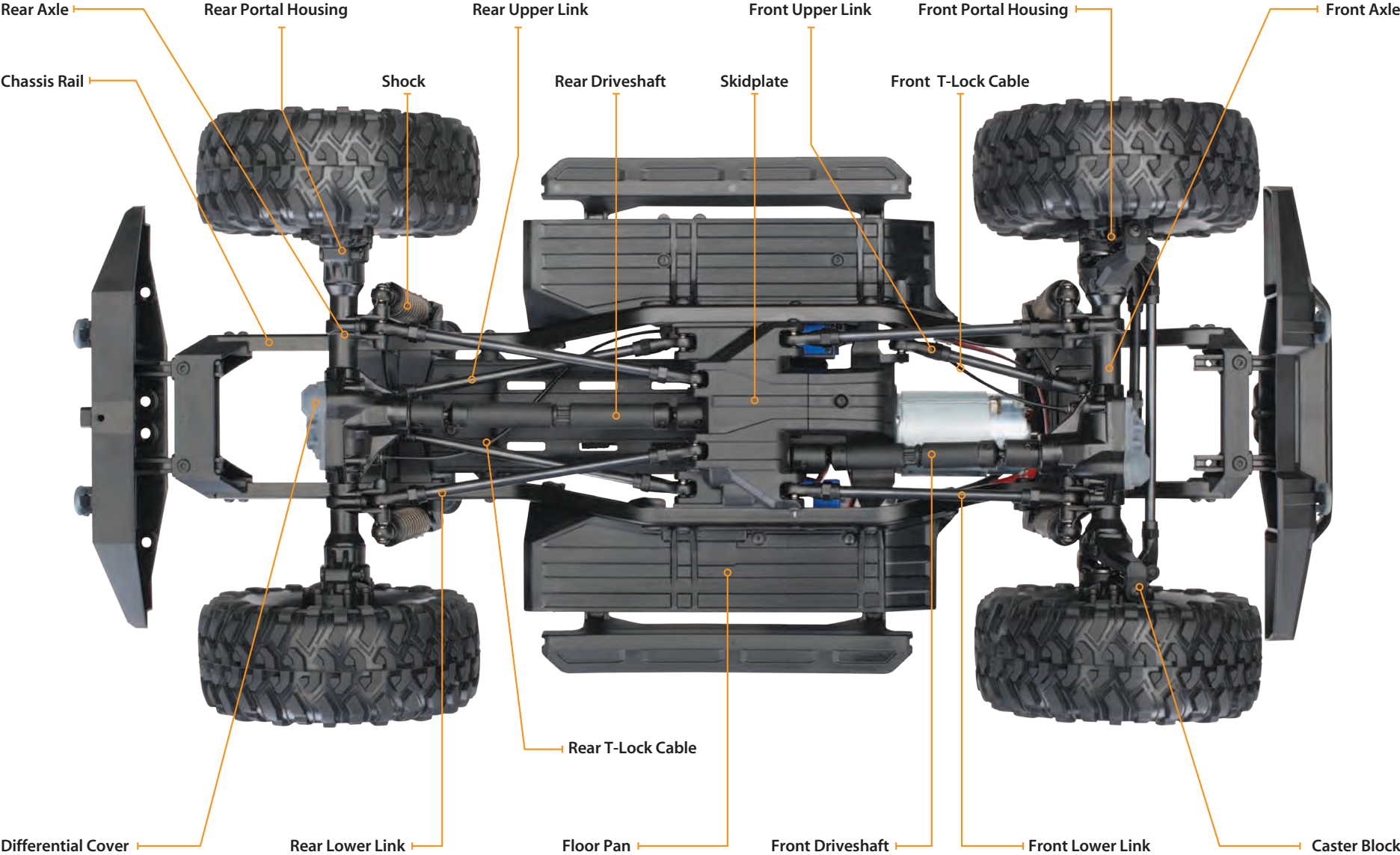

QUICK START: GETTING UP TO SPEED



The Quick Start Guide is not intended to replace the full operating instructions available in this manual. Please read this entire manual for complete instructions on the proper use and maintenance of your model.

Look for the Quick Start logo at the bottom of Quick Start pages.



The following guide is an overview of the procedures for getting your model running. Look for the Quick Start logo on the bottom corners of Quick Start pages.

1. Read the safety precautions on page 4

For your own safety, understand where carelessness and misuse could lead to personal injury.

6. Check servo operation • See page 16

Make sure the steering servos are working correctly.

2. Install batteries in the transmitter • See page 13

The transmitter requires 4 AA alkaline batteries (sold separately).

7. Range test the radio system • See page 16

Follow this procedure to make sure your radio system works properly at a distance and that there is no interference from outside sources.

3. Charge the battery pack • See page 13

Your model requires a battery pack and a compatible battery charger (not included). Never use a NiMH or NiCad charger to charge LiPo batteries.

8. Detail your model • See page 11

Apply other decals if desired.

4. Install battery packs in the model • See page 14

Your model requires a fully charged battery pack (not included).

9. Drive your model • See page 21

Driving tips and adjustments for your model.

5. Turn on the radio system • See page 15

Make a habit of turning the transmitter on first and off last.

10. Maintaining your model • See page 30

Follow these critical steps to maintain the performance of your model and keep it in excellent running condition.

INTRODUCTION

Your model includes the latest Traxxas TQi 2.4GHz transmitter with Traxxas Link™ Model Memory. The transmitter's easy-to-use design provides instant driving fun for new R/C enthusiasts, and also offers a full complement of pro-level tuning features for advanced users – or anyone interested in experimenting with the performance of their model. The steering and throttle channels feature adjustable Exponential, End Points, and Sub-Trims. Steering and braking Dual-Rate are also available. Many of the next-level features are controlled by the Multi-Function knob, which can be programmed to control a variety of functions. The detailed instructions (page 31) and Menu Tree (page 34) included in this manual will help you understand and operate the advanced functions of the new TQi radio system. For additional information and how-to videos, visit Traxxas.com.

RADIO AND POWER SYSTEM TERMINOLOGY

Please take a moment to familiarize yourself with these radio and power system terms. They will be used throughout this manual. A detailed explanation of the advanced terminology and features of your new radio system begins on page 31.

BEC (Battery Eliminator Circuit) - The BEC can either be in the receiver or in the ESC. This circuit allows the receiver and servos to be powered by the main battery pack in an electric model. This eliminates the need to carry a separate pack of 4 AA batteries to power the radio equipment.

Current - Current is a measure of power flow through the electronics, usually measured in amps. If you think of a wire as a garden hose, current is a measure of how much water is flowing through the hose.

ESC (Electronic Speed Control) - An electronic speed control is the electronic motor control inside the model. The XL-5 HV uses MOSFET power transistors to provide precise, digital proportional throttle control. Electronic speed controls use power more efficiently than mechanical speed controls so that the batteries run longer. An electronic speed control also has circuitry that prevents loss of steering and throttle control as the batteries lose their charge.

Frequency band - The radio frequency used by the transmitter to send signals to your model. This model operates on the 2.4GHz direct-sequence spread spectrum.

LiPo - Abbreviation for Lithium Polymer. Rechargeable LiPo battery packs are known for their special chemistry, which allows extremely high energy density and current handling in a compact size. These are high performance batteries that require special care and handling. LiPo battery packs are for advanced users only.

mAh - Abbreviation for milliamp hour, a measure of the capacity of the battery pack. The higher the number, the longer the battery will last between recharges.

Neutral position - The standing position that the servos seek when the transmitter controls are at the neutral setting.

NiCad - Abbreviation for nickel-cadmium. The original rechargeable hobby pack, NiCad batteries have very high current handling, high capacity, and can last up to 1000 charging cycles. Good charging procedures are required to reduce the possibility of developing a “memory” effect and shortened run times.

NiMH - Abbreviation for nickel-metal hydride. Rechargeable NiMH batteries offer high current handling and much greater resistance to the “memory” effect. NiMH batteries generally allow higher capacity than NiCad batteries. They can last up to 500 charge cycles. A peak charger designed for NiMH batteries is required for optimal performance.

Receiver - The radio unit inside your model that receives signals from the transmitter and relays them to the servos.

Resistance - In an electrical sense, resistance is a measure of how an object resists or obstructs the flow of current through it. When flow is constricted, energy is converted to heat and is lost.

Servo - Small motor unit in your model that operates the steering mechanism.

Transmitter - The hand-held radio unit that sends throttle and steering instructions to your model.

Trim - The fine-tuning adjustment of the neutral position of the servos, made by adjusting the throttle and steering trim knobs on the face of the transmitter. **Note:** *The Multi-Function knob must be programmed to serve as a throttle trim adjustment.*

Thermal Shutdown Protection - Temperature sensing electronics are used in the ESC to detect overloading and overheating of the transistor circuitry. If excessive temperature is detected, the unit automatically shuts down to prevent damage to the electronics.

2-channel radio system - The TQ radio system, consisting of the receiver, the transmitter, and the servos. The system uses two channels: one to operate the throttle and one to operate the steering.

2.4GHz Spread Spectrum - This model is equipped with the latest R/C technology. Unlike AM and FM systems that require frequency crystals and are prone to frequency conflicts, the TQi system automatically selects and locks onto an open frequency and offers superior resistance to interference and “glitching.”

Voltage - Voltage is a measure of the electrical potential difference between two points, such as between the positive battery terminal and ground. Using the analogy of the garden hose, while current is the quantity of water flow in the hose, voltage corresponds to the pressure that is forcing the water through the hose.

550 and 540 - These numbers refer to the size of the motor. 550 motors have armatures that are 30% longer than 540 motors.



Applying the Decals

The main decals for your model have been applied at the factory. Additional decals are printed on self-adhesive clear mylar and are die-cut for easy removal. Use a hobby knife to lift the corner of a decal and lift it from the backing.

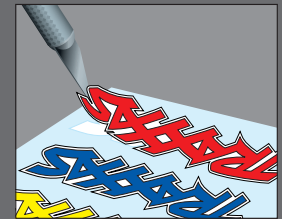

To apply the decals, place one end down, hold the other end up, and gradually smooth the decal down with your finger as you go. This will prevent air bubbles. Placing both ends of the decal down and then trying to smooth it out will result in air pockets. Look at the photos on the box for typical decal placement.

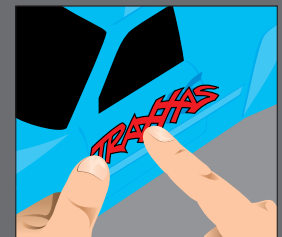

XL-5 HV Wiring Diagram

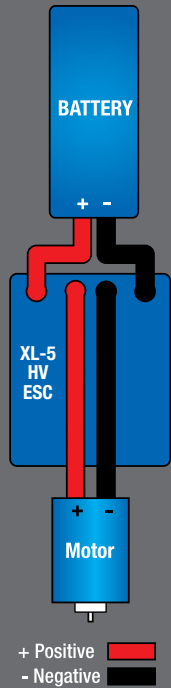

Your model is equipped with the newest TQi 2.4GHz transmitter with Traxxas Link™ Model Memory. The transmitter has five channels for controlling your throttle, steering, front and rear T-Lock differentials, and 2-speed transmission. The receiver inside the model has 5 output channels. Your model is equipped with four servos and an electronic speed control.

TRANSMITTER AND RECEIVER



** Accessory sensor port for use with the Telemetry Expander Module (see Traxxas.com and included materials for more information)

MODEL WIRING DIAGRAM

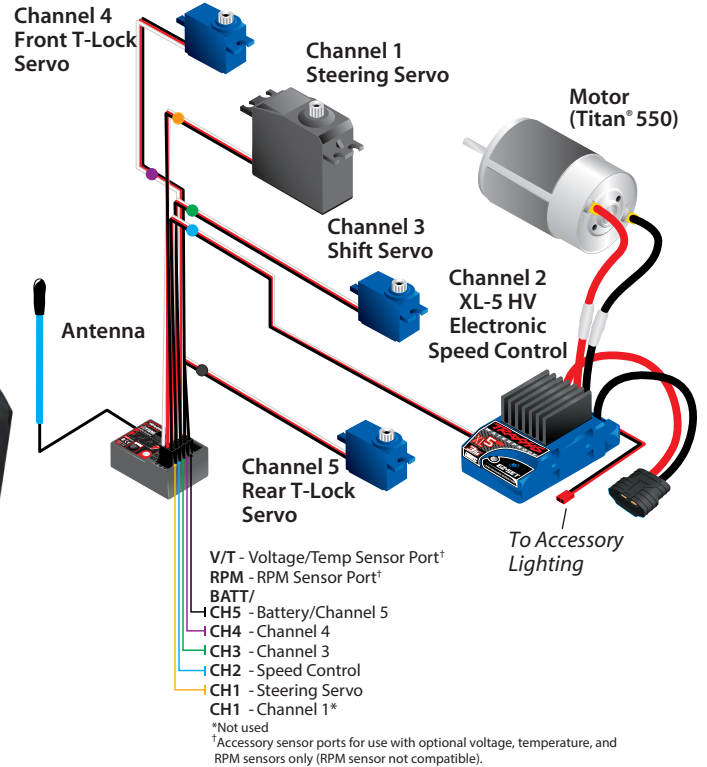

XL-5 HV ELECTRONIC SPEED CONTROL

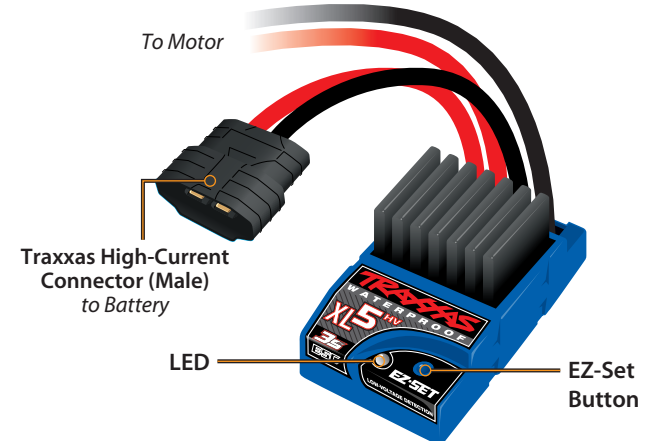

INSTALLING TRANSMITTER BATTERIES

Your TQi transmitter uses 4 AA batteries. The battery compartment is located in the base of the transmitter.



1. Remove the battery compartment door by pressing the tab and sliding the door open.
2. Install the batteries in the correct orientation as indicated in the battery compartment.
3. Reinstall the battery door and snap it closed.
4. Turn on the transmitter and check the status indicator for a solid green light.

If the status LED flashes red, the transmitter batteries may be weak, discharged or possibly installed incorrectly. Replace with new batteries. The power indicator light does not indicate the charge level of the battery pack installed in the model. Refer to the Troubleshooting section on page 32 for more information on the transmitter Status LED codes.



SELECTING BATTERIES AND A CHARGER FOR YOUR MODEL

Your model does not include a battery or charger. The speed control in the model is compatible with both LiPo and NiMH batteries. One NiMH or 2s/3s LiPo battery equipped with a Traxxas High-Current Connector is required. Traxxas Power Cell iD batteries are strongly recommended for maximum performance and safer charging. The following chart lists all the available Power Cell batteries for your model:

LiPo Batteries with iD

- 2849X 4000mAh 11.1v 3-Cell 25C LiPo Battery
- 2872X 5000mAh 11.1V 3-Cell 25C LiPo Battery
- 2843X 5800mAh 7.4V 2-Cell 25C LiPo Battery
- 2869X 7600mAh 7.4V 2-Cell 25C LiPo Battery

NiMH Batteries with iD

- 2923X Battery, Power Cell, 3000mAh (NiMH, 7-C flat, 8.4V)
- 2940X Battery, Series 3 Power Cell, 3300mAh (NiMH, 7-C flat, 8.4V)
- 2950X Battery, Series 4 Power Cell, 4200mAh (NiMH, 7-C flat, 8.4V)
- 2960X Battery, Series 5 Power Cell, 5000mAh (NiMH, 7-C flat, 8.4V)



WARNING: FIRE HAZARD!

Users of Lithium Polymer (LiPo) batteries must read the Warnings and Precautions beginning on page 4. You **MUST** use a LiPo charger for LiPo batteries or battery damage with the potential for fire will result.

Make certain you choose the correct type of charger for the batteries you select. Traxxas recommends you choose a genuine Traxxas EZ-Peak iD charger for safer charging and maximum battery life and performance.

Charger	Part No.	NiMH Compatible	LiPo Compatible	Battery iD	Max. Cells
EZ-Peak Plus, 4 amps	2970	YES	YES	YES	3s
EZ-Peak Live, 12 amps	2971	YES	YES	YES	4s
EZ-Peak Dual, 8 amps	2972	YES	YES	YES	3s
EZ-Peak Live Dual, 26+ amps	2973	YES	YES	YES	4s



If the status LED doesn't light green, check the polarity of the batteries. If you see any other flashing signal from the LED, refer to the chart on page 32 to identify the code.



Use the Right Batteries

Your transmitter uses AA batteries. Use new alkaline batteries. Do not use rechargeable AA cells to power the TQi transmitter, as they will not provide sufficient voltage for optimum transmitter performance.

Caution: Discontinue running your model at the first sign of weak batteries (flashing red light) to avoid losing control.





Battery iD

Traxxas recommended battery packs are equipped with Traxxas Battery iD. This exclusive feature allows Traxxas battery chargers (sold separately) to automatically recognize connected battery packs and optimize the charge settings for the battery. This eliminates the need to worry over charger settings and menus for the easiest and safest charging solution possible. Visit Traxxas.com to learn more about this feature and available Traxxas iD chargers and batteries.

INSTALLING THE BATTERY PACK

WARNING: Do not pinch the battery wires or connector between the body wheel wells and the chassis when installing the battery.

Install the battery pack with the battery wires facing the rear of the model. Swing the battery hold down towards the chassis and snap (lock) the end into the front hold-down retainer.

Note: The battery hold down can be rotated on its pivot to accommodate different height battery packs.



INSTALLING THE BODY

To secure the TRX-4 Defender body to the frame to prevent body shake and provide support for the spare tire and accessories in the rear, align the body with the rear bumper and rock sliders as shown below.

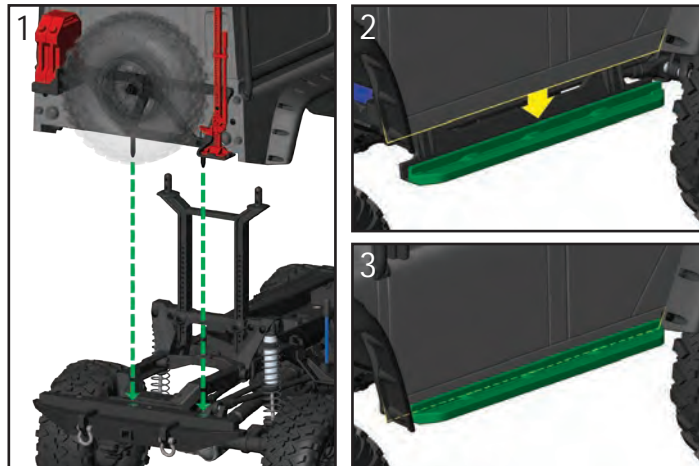

The Traxxas High-Current Connector

Your model is equipped with the Traxxas High-Current Connector. Standard connectors restrict current flow and are not capable of delivering the power needed to maximize the output of the XL-5 HV. The Traxxas connector's gold-plated terminals with large contact surfaces ensure positive current flow with the least amount of resistance. Secure, long-lasting, and easy to grip, the Traxxas connector is engineered to extract all the power your battery has to give.



RADIO SYSTEM CONTROLS



- Always use new batteries for the radio system. Weak batteries will limit the radio signal between the receiver and the transmitter. Loss of the radio signal can cause you to lose control of your model.
- In order for the transmitter and receiver to bind to one another, the receiver in the model must be turned on within 20 seconds of turning on the transmitter. The transmitter LED will flash fast red, indicating a failure to link. If you miss it, simply turn off the transmitter and start over.
- Always turn on the transmitter before plugging in the battery.

RADIO SYSTEM BASIC ADJUSTMENTS

Steering Trim

Turn the steering trim knob to precisely set the steering neutral point. To adjust, drive the vehicle forward slowly while “steering” with the trim knob until the vehicle travels in a straight line with no steering input.



Multi-Function Knob

The Multi-Function knob can be programmed to control a variety of functions. From the factory, the Multi-Function knob controls Cruise Control on the TRX-4. For more detail on the cruise control, refer to page 17.

RADIO SYSTEM RULES

- Always turn your TQi transmitter on first and off last. This procedure will help to prevent your model from receiving stray signals from another transmitter, or other source, and running out of control. Your model has electronic fail-safes to prevent this type of malfunction, but the first, best defense against a runaway model is to always turn the transmitter on first and off last.

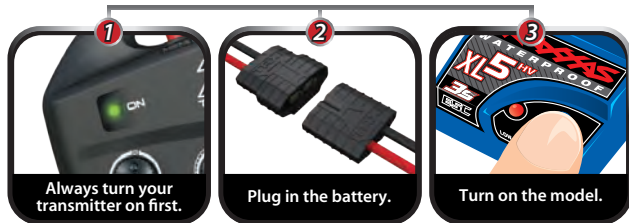

Remember, always turn the TQi transmitter on first and off last to avoid damage to your model.



Stop immediately at the first sign of weak batteries. Never turn the transmitter off when the battery pack is plugged in. The model could run out of control.



Automatic Fail-Safe

The TQi transmitter and receiver are equipped with an automatic fail-safe system that does not require user programming. In the event of signal loss or interference, the throttle will return to neutral and the steering will hold its last commanded position. If the fail-safe activates while you are operating your model, determine the reason for signal loss and resolve the problem before operating your model again.

In order to re-acquire the signal after the fail-safe has activated, you will need to walk a longer distance closer to the model than the distance the model travelled out of range. Simply keep walking towards the model until you re-acquire the signal.

USING THE RADIO SYSTEM

The TQi Radio System has been pre-adjusted at the factory. The adjustment should be checked before running the model in case of movement during shipping. Here's how:

1. Turn the transmitter switch on. The status LED on the transmitter should be solid green (not flashing).
2. **Elevate the model on a block or a stand so that all the tires are off the ground.** Make sure your hands are clear of the moving parts of the model.
3. Plug the battery pack in the model into the speed control.
4. Press and release the EZ-Set button on the speed control to turn the model on. The speed control's LED will glow green, indicating that Low-Voltage Detection is activated to prevent over-discharging of LiPo batteries (this may cause poor performance from NiMH battery packs). **Never use LiPo batteries while Low-Voltage Detection is disabled.** See page 18 for more information. To turn the speed control off, press the EZ-Set button until the LED turns off.
5. Turn the steering wheel on the transmitter back and forth and check for rapid operation of the steering servo. Also, check that the steering mechanism is not loose or binding. If the steering operates slowly, check for weak batteries.
6. When looking down at the model, the front wheels should be pointing straight ahead. If the wheels are turned slightly to the left or right, slowly adjust the steering trim control on the transmitter until they are pointing straight ahead.
7. Gently operate the throttle trigger to ensure that you have forward and reverse operation, and that the motor stops when the throttle trigger is at neutral. **WARNING: Do not apply full throttle in forward or reverse while the model is elevated.**
8. Once adjustments are made, turn off the receiver on your model, followed by the hand-held transmitter.



Range-Testing the Radio System

Before each running session with your model, you should range-test your radio system to ensure that it operates properly.

1. Turn on the radio system and check its operation as described in the previous section.
2. Have a friend hold the model. Make sure hands and clothing are clear of the wheels and other moving parts on the model.
3. Walk away from the model with the transmitter until you reach the farthest distance you plan to operate the model.
4. Operate the controls on the transmitter once again to be sure that the model responds correctly.
5. Do not attempt to operate the model if there is any problem with the radio system or any external interference with your radio signal at your location.

Your model's radio system is designed to operate reliably up to the approximate distance that it is no longer easy or comfortable to see and control the model. Most drivers will struggle to see and drive their model at distances farther than a football field (300+ feet). At greater distances, you could lose sight of your model and you may also exceed the radio system's operating range, which will cause the failsafe system to activate. For best visibility and control of your model, keep your model within 200 feet, regardless of the maximum range available.

No matter how far you drive your model, always leave adequate space between you, the model, and others. Never drive directly toward yourself or others.

TQi Binding Instructions

For proper operation, the transmitter and receiver must be electronically “bound.” **This has been done for you at the factory.** Should you ever need to re-bind the system or bind to another transmitter or receiver, follow these instructions. **Note:** *The receiver must be connected to a 4.8-6.0v (nominal) power source for binding. Vehicles equipped with an electronic speed control contain a BEC that provides a lower voltage to power the receiver (see page 11). The transmitter and receiver must be within 5 feet of each other.*

1. Press and hold the transmitter’s SET button as you switch the transmitter on. The transmitter’s LED will flash red slowly. Release the SET button.
2. Press and hold the receiver’s LINK button as you switch on the speed control (by pressing the EZ-Set button). Release the LINK button.
3. When the transmitter and receiver’s LEDs turn solid green, the system is bound and ready for use. Confirm that the steering and throttle operate properly before driving your model.

Cruise Control

The Multi-Function Knob on the TQi transmitter has been programmed to control Cruise Control on the TRX-4, which maintains vehicle speed for more comfortable long-distance travel (such as hiking on trails).

To operate Cruise Control, accelerate to your desired speed and press the SET button on the transmitter to lock the speed in. Your model will continue at the set speed until you apply the brakes.



You can fine tune the speed to exactly match your pace by adjusting the multi-function knob on the transmitter. Turn the knob clockwise to increase speed, counterclockwise to reduce speed. You can accelerate and drive faster with the Cruise Control set, and the vehicle will resume the set speed when the throttle is released (*Resume function*).



SETTING UP THE ANTENNA

The receiver antenna has been set up and installed from the factory. The antenna is secured by a 3x4mm set screw. To remove the antenna tube, simply remove the set screw with the included 1.5mm wrench.

When reinstalling the antenna, first slide the antenna wire into the bottom of the antenna tube until the white tip of the antenna is at the top of the tube under the black cap. Next, insert the antenna tube into the mount while making sure that the antenna wire is in the slot in the antenna mount; then, install the set screw next to the antenna tube. Use the supplied 1.5mm wrench to tighten the screw just until the antenna tube is securely in place. Do not over tighten. **Do not bend or kink the antenna wire! See the side bar for more information. Do not shorten the antenna tube.**

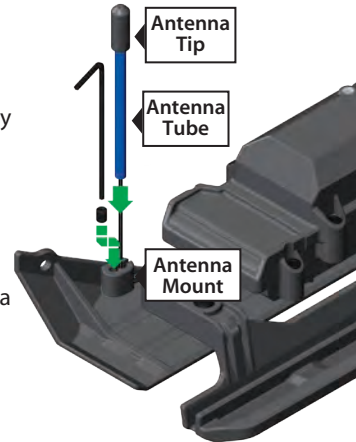

To prevent loss of radio range do not kink or cut the black wire, do not bend or cut the metal tip, and do not bend or cut the white wire at the end of the metal tip.

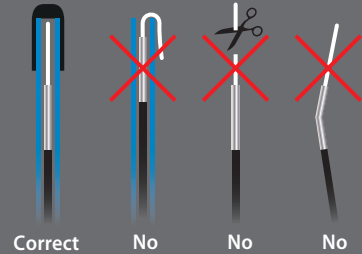

ADJUSTING THE ELECTRONIC SPEED CONTROL

XL-5 HV Specifications

Input Voltage
6-7 cells NiMH; 2s/3s LiPo

Case Size
1.23"W x 2.18"L x 1.11"H

Weight
2.6 ounces / 74 grams

Motor Limit
12-turns (550 size) with 2s LiPo
21-turns (550 Size) with 3s LiPo

On Resistance Forward
0.004 Ohms

On Resistance Reverse
0.004 Ohms

Peak Current - Forward
100A

Peak Current - Reverse
60A

Braking Current
60A

Continuous Current
18A

BEC Voltage
6.0 VDC

BEC Current
1A

Power Wire
14 Gauge / 5"

Input Harness Wire
26 Gauge / 14.5"

Transistor Type
MOSFET

PWM Frequency
1700 Hz

Thermal Protection
Thermal Shutdown

Single Button Setup
Yes

Low-Voltage Detection
Yes (User Enabled)

XL-5 HV Battery Settings (Low-Voltage Detection Setting)

The XL-5 HV electronic speed control is equipped with built-in Low-Voltage Detection. The Low-Voltage Detection circuitry constantly monitors the battery voltage. When the battery voltage begins to reach the minimum recommended discharge voltage threshold for LiPo battery packs, the XL-5 HV will limit the power output to 50% throttle. When the battery voltage attempts to fall below the minimum threshold, the XL-5 HV will shut down all motor output. The LED on the speed control will slowly blink red, indicating a low-voltage shutdown. The XL-5 HV will stay in this mode until a fully charged battery is connected.

When you turn your model on, the XL-5 HV speed control's status LED will glow green, indicating that **Low-Voltage Detection is activated** to prevent over-discharging of LiPo batteries. **LiPo batteries are intended only for the most advanced users that are educated on the risks associated with LiPo battery use.**



WARNING: FIRE HAZARD!

Do not use LiPo batteries in this vehicle with Low-Voltage Detection disabled.

Verify that Low-Voltage Detection is ACTIVATED:

1. Turn on the transmitter (with the throttle at neutral).
2. Connect a fully charged battery pack to the XL-5 HV.
3. Press and release the EZ-Set button to turn the XL-5 HV on. If the LED is solid green, then the Low-Voltage Detection is ACTIVATED.

If Low-Voltage Detection is DISABLED:

1. Make sure the LED on the XL-5 HV is on and RED.
2. Press and hold the EZ-Set button (the LED will turn off). After ten seconds, the motor will beep twice and the LED will shine GREEN. Release the button.
3. Low-Voltage Detection is now ACTIVATED.



For NiMH battery users, follow these steps to disable Low-Voltage Detection (NiMH setting):

1. Make sure the LED on the XL-5 HV is on and GREEN.
2. Press and hold the EZ-Set button (the LED will turn off). After ten seconds, the motor will beep three times and the LED will shine RED. Release the button.
3. Low-Voltage Detection is now DISABLED.



XL-5 HV Setup Programming (Calibrating your ESC and transmitter)

Read through all of the programming steps before you begin. If you get lost during programming or receive unexpected results, simply unplug the battery, wait a few seconds, plug the battery pack in, and start over.

1. Disconnect one of the motor wires between the XL-5 HV and the motor. This is a precaution to prevent runaway when the speed control is turned on before it is programmed.
2. Connect a fully charged battery pack to the XL-5 HV.
3. Turn on the transmitter (with the throttle at neutral).
4. Press and hold the EZ-Set button (A). The LED will first turn green and then red. Release the button.
5. When the LED blinks RED ONCE, pull the throttle trigger to the full throttle position and hold it there (B).
6. When the LED blinks RED TWICE, push the throttle trigger to the full reverse and hold it there (C).

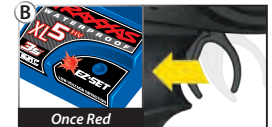

Note: If you are calibrating to clear an error code on the ESC, then skip step 7 and proceed to step 8.

7. When the LED blinks GREEN ONCE, programming is complete. The LED will then shine green or red (depending on Low-Voltage Detection setting).
8. When the LED blinks GREEN ONCE, continue holding the trigger in the reverse position and also press and hold the button on the ESC for about 10 seconds until the ESC beeps. This places the ESC in NiMH mode and clears any error codes.

XL-5 HV Operation

To operate the speed control and test the programming, reconnect the motor wires and place the vehicle on a stable block or stand so that all of the driven wheels are off the ground.

Note that in steps 1-8 below, Low-Voltage Detection is ACTIVATED (factory default) and the LED shines green. If Low-Voltage Detection is DISABLED, the LED will shine red instead of green in steps 1-8 below.

1. With the transmitter on, press and release the EZ-Set button. The LED will shine GREEN. This turns the XL-5 HV on. If you press and

release too quickly, you may hear the steering servo jump but the LED may not stay on. Simply press the button again until the LED shines GREEN, and then release.

- Apply forward throttle. The LED will turn off until full throttle power is reached. At full throttle, the LED will shine GREEN.
- Move the trigger forward to apply the brakes. Note that braking control is fully proportional. The LED will turn off until full braking power is reached. At full brakes, the LED will shine GREEN.
- Return the throttle trigger to neutral. The LED will shine GREEN.
- Move the throttle trigger forward again to engage reverse (Profile #1). The LED will turn off. Once full reverse power is reached, the LED will shine GREEN.
- To stop, return the throttle trigger to neutral. Note that there is no programmed delay when changing from reverse to forward. Use caution to avoid slamming the speed control from reverse to forward. On high-traction surfaces, this could result in transmission or driveline damage.
- To turn the XL-5 HV off, press and hold the EZ-Set button for 1½ seconds or until the green LED turns off.
- The XL-5 HV is equipped with thermal shutdown protection to guard against overheating caused by excessive current flow. If the operating temperature exceeds safe limits, the XL-5 HV will automatically shut down. The LED on the face of the XL-5 HV will rapidly blink red, even if the throttle trigger is moved back and forth. Once the temperature returns to a safe level, the XL-5 HV will once again function normally.

XL-5 HV Profile Selection

The speed control is factory set to Trail Mode (100% forward, brakes, and reverse; added brake drag when the throttle trigger is at neutral). To activate full power without the additional brake drag (Sport Mode), disable reverse (Race Mode), allow 50% power (patented Training Mode), or set immediate reverse (Crawl Mode), follow these steps. The speed control should be connected to the receiver and the transmitter adjusted as described previously. The profiles are selected by entering the programming mode.

Profile Description

- Profile #1 (Sport Mode): 100% Forward, 100% Brakes, 100% Reverse
- Profile #2 (Race Mode): 100% Forward, 100% Brakes, No Reverse
- Profile #3 (Training Mode): 50% Forward, 100% Brakes, 50% Reverse
- Profile #4 (Trail Mode): 100% Forward, 100% Brakes, 100% Reverse; Drag Brake at Neutral
- Profile #5 (Crawl Mode): 100% Forward, Hill Hold Brakes at Neutral, Immediate Reverse

Selecting Sport Mode

(Profile #1: 100% Forward, 100% Brakes, 100% Reverse)

- Connect a fully charged battery pack to the XL-5 HV and turn on your transmitter.
- With the XL-5 HV off, press and hold the EZ-Set button until the LED turns solid green, then solid red and then begins blinking red (indicating the Profile numbers).
- When the LED blinks RED ONCE, release the EZ-Set button.
- The LED will blink and then turn solid green (Low-Voltage Detection ACTIVE) or red (Low-Voltage Detection DISABLED). The model is ready to drive.

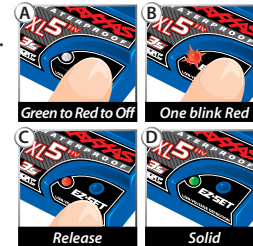

Selecting Race Mode

(Profile #2: 100% Forward, 100% Brakes, No Reverse)

- Connect a fully charged battery pack to the XL-5 HV and turn on your transmitter.
- With the XL-5 HV off, press and hold the EZ-Set button until the LED turns solid green, then solid red and then begins blinking red (indicating the Profile numbers).
- When the LED blinks RED TWICE, release the EZ-Set button.
- The LED will blink and then turn solid green (Low-Voltage Detection ACTIVE) or red (Low-Voltage Detection DISABLED). The model is ready to drive.

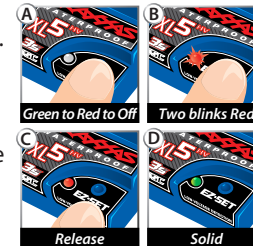

Selecting Training Mode

(Profile #3: 50% Forward, 100% Brakes, 50% Reverse)

- Connect a fully charged battery pack to the XL-5 and turn on your transmitter.
- With the XL-5 off, press and hold the EZ-Set button until the LED turns solid green, then solid red and then begins blinking red (indicating the Profile numbers).
- When the LED blinks RED THREE TIMES, release the EZ-Set button.
- The LED will blink and then turn solid green (Low-Voltage Detection ACTIVE) or red (Low-Voltage Detection DISABLED). The model is ready to drive.

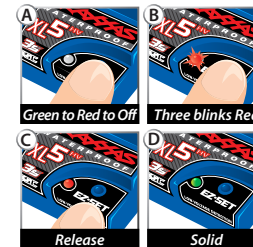

Patented Training Mode (Profile #3) reduces forward and reverse throttle by 50%. Training Mode is provided to reduce the power output, allowing beginning drivers to better control the model. As driving skills improve, simply change to Sport, Race, Trail, or Crawl Mode for full-power operation.



Tip For Fast Mode Changes
The XL-5 HV is set to Profile 4 (Trail Mode) as the default. To quickly change to Profile 3 (Training Mode), with the transmitter on, press and hold the EZ-Set button until the light blinks red three times and then release. Quickly change back to Profile 4 (Trail Mode) by pressing and holding the EZ-Set button until the light blinks red four times and then releasing.



Throttle Neutral Protection

The XL-5 HV speed control features Throttle Neutral Protection, which prevents the model from suddenly accelerating if the speed control is switched on while the transmitter's trigger is being held. When the trigger is returned to neutral, the XL-5 HV will operate properly.

Selecting Trail Mode

(Profile #4: 100% Forward, 100% Brakes, 100% Reverse; Drag Brake at Neutral)

1. Connect a fully charged battery pack to the XL-5 HV and turn on your transmitter.
2. With the XL-5 HV off, press and hold the EZ-Set button until the LED turns solid green, then solid red and then begins blinking red (indicating the Profile numbers).
3. When the LED blinks RED FOUR TIMES, release the EZ-Set button.
4. The LED will blink and then turn solid green (Low-Voltage Detection ACTIVE) or red (Low-Voltage Detection DISABLED). The model is ready to drive.

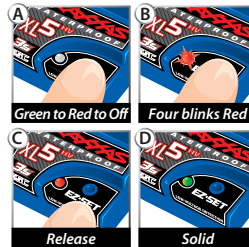

Selecting Crawl Mode

(Profile #5: 100% Forward, Hill Hold Brakes at Neutral, Immediate Reverse)

1. Connect a fully charged battery pack to the XL-5 HV and turn on your transmitter.
2. With the XL-5 HV off, press and hold the EZ-Set button until the LED turns solid green, then solid red and then begins blinking red (indicating the Profile numbers).
3. When the LED blinks RED FIVE TIMES, release the EZ-Set button.
4. The LED will blink and then turn solid green (Low-Voltage Detection ACTIVE) or red (Low-Voltage Detection DISABLED). The model is ready to drive.



Note: If you missed the mode you wanted, keep the EZ-Set button pressed down and the blink cycle will repeat until the button is released and a Mode is selected.

LED Codes and Protection Modes

- **Solid Green:** XL-5 HV power-on light. Low-Voltage Detection is ACTIVATED (LiPo setting).
- **Solid Red:** XL-5 HV power-on light. Low-Voltage Detection is DISABLED (NiMH setting).



WARNING: FIRE HAZARD!

Do not use LiPo batteries in this vehicle with Low-Voltage Detection disabled.

- **Fast Blinking Red:** Overtemp. The XL-5 HV is equipped with thermal shutdown protection to guard against overheating caused by excessive current flow. If the operating temperature exceeds safe limits, the XL-5 HV will automatically shut down. Let the XL-5 HV cool before continuing. The ESC can get too hot in situations such as climbing and crawling in high gear, which increases load on the system. Use low gear for climbing and crawling.
- **Slow Blinking Red (when Low-Voltage Detection is activated):** The XL-5 HV has entered Low-Voltage Protection. When the battery voltage begins to reach the minimum recommended discharge voltage threshold for LiPo battery packs, the XL-5 HV will limit the power output to 50% throttle. When the battery voltage attempts to fall below the minimum threshold, the XL-5 HV will shut down all motor output. The LED on the speed control will slowly blink red, indicating a low-voltage shutdown. The XL-5 HV will stay in this mode until a fully charged battery is connected. If you see this code because a NiMH battery was connected to an ESC with Low-Voltage Detection turned on, then follow the calibration steps from the previous page to release the code and change the ESC to NiMH mode.
- **Fast Blinking Red and Green:** Overvoltage. This code can appear when a fully charged NiMH battery is connected to the XL-5 HV ESC with Low-Voltage Detection turned on. Follow the calibration steps from the previous page to release the code and change the ESC to NiMH mode.
- **Fast Blinking Green:** The XL-5 HV's LED will blink fast green if the speed control is not receiving a signal. Make certain the speed control is properly plugged into the receiver and the transmitter is switched on.

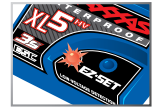

Now it's time to have some fun! This section contains instructions on driving and making adjustments to your model. Before you go on, here are some important precautions to keep in mind.

- Allow the model to cool for a few minutes between runs. This is particularly important when using high-capacity battery packs that allow extended periods of running. Monitoring temperatures will extend the lives of the batteries and motor.
- Do not continue to operate the model with low batteries or you could lose control of it. Indications of low battery power include slow operation and sluggish servos (slow to return to center). Stop immediately at the first sign of weak batteries. When the batteries in the transmitter become weak, the red power light will begin to flash. Stop immediately and install new batteries.
- Do not drive the model at night, on public streets, or in large crowds of people.
- Drive the TRX-4 primarily in low gear for maximum torque. High gear can be used for high-speed running on open trails or when clearing steep slopes or gaps in rocks. Driving in high gear for extended periods of time can result in the motor and/or ESC overheating and premature motor wear.
- If the model becomes stuck against an object, do not continue to run the motor. Remove the obstruction before continuing. Do not push or pull objects with the model.
- If an obstacle cannot be cleared by slow crawling, slowly increase the vehicle speed as you drive toward the obstacle to allow the suspension links and skiplates of the TRX-4 to slide over it.
- Because the model is controlled by radio, it is subject to radio interference from many sources beyond your control. Since radio interference can cause momentary losses of control, allow a safety margin of space in all directions around the model in order to prevent collisions.
- Use good, common sense whenever you are driving your model. Intentionally driving in an abusive and rough manner will only result in poor performance and broken parts. Take care of your model so that you can enjoy it for a long time to come.
- High-performance vehicles produce small vibrations that may loosen hardware over time. Frequently check wheel nuts and other screws on your vehicle to ensure that all hardware remains properly tightened.

Operating the High-Low Transmission

TRX-4's High-Low transmission is operated via the red rocker switch above the transmitter grip; depressing the upper part of the switch engages Low, depressing the lower part of the switch engages High. TRX-4 may be shifted from low gear into high gear at any speed. For smoother operation, reduce the speed of the model before shifting from high gear into low gear. This will reduce strain on the transmission gears. Although TRX-4's Titan 550 motor has ample torque for climbing and crawling in second gear, using first gear in situations that require low speed will extend motor life.



High Gear



Low Gear

Operating the T-Lock Differentials

The switch on top of the transmitter operates the front and rear differential locking mechanism. The differentials can be locked or unlocked at any time during most driving conditions. If the model is stuck and there is wheelspin on a single wheel (one side of an unlocked differential is freewheeling), then release the throttle and allow the wheels to stop before locking the differential. Apply throttle slowly until the differentials fully engage or disengage.



For most driving, the TRX-4 will perform best with both differentials unlocked or "open" (T-Lock switch back). This will give TRX-4 maximum steering performance and the tightest possible turning radius, and will also reduce strain on the drive components. If open differentials cause you to lose traction over loose terrain or when traversing an obstacle, you can use the T-Lock switch to lock the front differential or both differentials. Lock the front differential for enhanced climbing ability and traction by moving the T-Lock switch to the middle position. Apply throttle slowly until the T-Lock engages (it will take just a moment), then use the throttle as needed. Lock both differentials for maximum climbing ability and traction by moving the T-Lock switch to the forward-most position. As with a full-size 4WD vehicle, TRX-4's high-speed handling and steering precision are reduced when one or both differentials are locked. Locked differentials can be used at any time, but unlocking the differentials greatly improves vehicle handling during high-speed driving.

About Run Time

A large factor affecting run time is the type and condition of your batteries. The milliamp hour (mAh) rating of the batteries determines how large their “fuel tank” is. A 3000 mAh battery pack will theoretically run twice as long as a 1500 mAh sport pack. Because of the wide variation in the types of batteries that are available and the methods with which they can be charged, it’s impossible to give exact run times for the model. Another major factor that affects run time is how the model is driven. Run times may decrease when the model is driven repetitively from a stop to top speed and with repetitive hard acceleration.

Tips for Increasing Run Time

- Use batteries with the highest mAh rating you can purchase.
- Use a high-quality peak-detecting charger.
- Read and follow all maintenance and care instructions provided by the manufacturer of your batteries and charger.
- Keep the XL-5 HV cool. Get plenty of airflow across the ESC heat sink.
- Lower your gear ratio. Installing a smaller pinion gear will lower your gear ratio and cause less power draw from the motor and batteries, and reduce overall operating temperatures.
- Maintain your model. Do not allow dirt or damaged parts to cause binding in the drivetrain. Keep the motor clean.

mAh Ratings and Power Output

The mAh rating of the battery can affect your top-speed performance. The higher capacity battery packs experience less voltage drop under heavy load than low mAh rated packs. The higher voltage potential allows increased speed until the battery begins to become discharged.

RUNNING IN WET CONDITIONS

Your new Traxxas TRX-4 is designed with water-resistant features to protect the electronics in the model (receiver, servos, electronic speed control). This gives you the freedom to have fun driving your TRX-4 through puddles, wet grass, snow, and through other wet conditions. Though highly water resistant, the TRX-4 should not be treated as though it is submersible or totally 100% waterproof. Water resistance applies only to the installed electronic components. Running in wet conditions requires additional care and maintenance for the mechanical and electrical components to prevent corrosion of metal parts and maintain their proper function.

Precautions

- **Without proper care, some parts of your model can be seriously damaged due to contact with water. Know that additional maintenance procedures will be required after running in wet conditions in order to maintain the performance of your model. Do not run your model in wet conditions if you are not willing to accept the additional care and maintenance responsibilities.**
- Not all batteries can be used in wet environments. Consult your battery manufacturer to see if their batteries can be used in wet conditions. Do not use LiPo batteries in wet conditions.
- The transmitter is not water resistant. Do not subject it to wet conditions, such as rain.
- Do not operate your model during a rain storm or other inclement weather where lightning may be present.
- Do not allow your model to come in contact with saltwater (ocean water), brackish water (between fresh water and ocean water), or other contaminated water. Saltwater is highly conductive and highly corrosive. Use caution if you plan to run your model on or near a beach.
- Even casual water contact can reduce the life of your motor. Special care must be taken to modify your driving style in wet conditions to extend the life of the motor (details below).

Before Running Your Vehicle in Wet Conditions

1. Consult the section “After Running Your Vehicle in Wet Conditions” before proceeding. Make sure you understand the additional maintenance required with wet running.
2. The wheels have small holes molded in to allow air to enter and exit the tire during normal running. Water will enter these holes and get trapped inside the tires. Cover the breather holes in all tires (including the spare) with adhesive tape to prevent possible damage to the foam inserts.
3. Confirm that the receiver box O-ring and cover are installed correctly and secure. Make sure the screws are tight and the blue o-ring is not visibly protruding from the edge of the cover. Confirm that the wire clamp has sufficient grease.
4. Confirm that your batteries can be used in wet conditions.
5. Use low gear when running in mud, deep puddles, snow, or similar situations that will restrict the tires and put much higher loads on the motor. Although the TRX-4’s Titan 550 motor has ample torque in second gear, using first gear in situations that require low speed will extend motor life. Limit second-gear use to high-speed running on dry ground.

Motor Precautions

- Titan 550 motor life can be greatly reduced in mud and water. If the motor gets excessively wet or submerged, use very light throttle (run the motor slowly) until the excess water can run out. Applying full throttle to a motor full of water can cause rapid motor failure. Your driving habits will determine motor life with a wet motor. Do not submerge the motor under water.
- Do not gear the motor by temperature when running in wet conditions. The motor will be cooled by water contact and will not give an accurate indication of appropriate gearing.

After Running Your Vehicle in Wet Conditions

1. Remove the batteries.
2. Rinse excess dirt and mud off the truck with low-pressure water, such as from a garden hose. Do not use a pressure washer or other high-pressure water. Avoid directing water into the bearings, transmission, differentials, etc.
3. Blow off the truck with compressed air (optional, but recommended). Wear safety glasses when using compressed air.
4. Remove the wheels from the truck.
5. Spray all the bearings, drivetrain, and fasteners with WD-40® or similar water-displacing light oil.
6. Let the truck stand or you may blow off with compressed air. Placing the truck in a warm, sunny spot will aid drying. Trapped water and oil will continue to drip from the truck for a few hours. Place it on a towel or piece of cardboard to protect the surface underneath.
7. As a precautionary step, remove the sealed receiver box cover. While unlikely, humidity or tiny amounts of moisture or condensation may enter the receiver box during wet running. This can cause long-term problems with the sensitive electronics in the receiver. Removing the receiver box cover during storage allows the air inside to dry. This step can improve the long-term reliability of the receiver. It is not necessary to remove the receiver or unplug any of the wires.

8. **Additional Maintenance:** Increase your frequency of disassembly, inspection, and lubrication of the following items. This is necessary after extended wet use or if the vehicle will not be used for an extended period of time (such as a week or longer). This additional maintenance is needed to prevent any trapped moisture from corroding internal steel components.

- **Portal gearboxes:** Open, dry, clean, and re-grease the gears and inspect for damage.
- **Front and rear differential:** Remove the differential covers to disassemble, clean, and re-grease the ring and pinion gears. Refer to your exploded view diagrams for help with disassembly and reassembly.
- **Transmission:** Remove, disassemble, clean, and re-grease the transmission components. Use a light coating of high-performance grease (such as Traxxas part #5041) on the metal gear teeth. No grease is required for the nylon gears. Refer to your exploded view diagrams for help with disassembly and reassembly.
- **Titan 550 motor:** Remove the motor, clean with aerosol motor cleaner, and re-oil the bushings with lightweight motor oil. Be sure to wear eye protection when using spray aerosol cleaners.



RECEIVER BOX: MAINTAINING A WATERTIGHT SEAL

Removing and Installing Radio Gear

The unique design of the receiver box allows the removal and installation of the receiver without losing the ability to maintain a watertight seal in the box. The patent-pending wire clamp feature gives you the ability to also install aftermarket radio systems and maintain the watertight features of the receiver box.

Removing the Receiver

1. To remove the cover, remove the three 3x8mm button-head cap screws.
2. To remove the receiver from the box, carefully pull it out (it is secured by double-sided adhesive foam tape) and set to the side. The antenna wire is still inside the clamp area and cannot be removed yet.
3. Remove the wire clamp by removing the two 2.5x8mm cap screws.
4. Unplug the servo cables from the receiver and remove the receiver.

Receiver Installation

1. Always install the wires into the box before installing the receiver.
2. Install the antenna wire and the servo cables into the receiver box.
3. Arrange the wires neatly using the wire guides in the receiver box. The excess wire will be bundled inside the receiver box. Label which wire is for which channel.

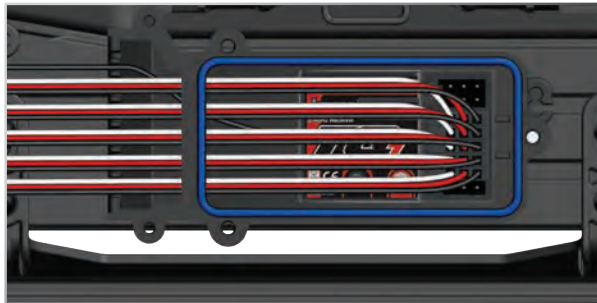

4. Apply a bead of silicone grease (Traxxas part #1647) to the wire clamp.



5. Install the wire clamp and tighten the two 2.5x8mm cap screws securely.
6. Using double-sided adhesive foam tape, install the receiver into the box.

Note: For best performance, it is recommended that the receiver be installed in the original orientation.

7. Plug the wires into receiver. Refer to page 12 for the wiring diagram.
8. Make sure the clear plastic light pipe in the receiver box is aligned above the LED on the receiver.
9. Make sure the o-ring is properly seated into the groove in the receiver box so that the cover will not pinch it or damage it in any way.
10. Install the cover and tighten the three 3x8mm button-head cap screws securely.
11. Inspect the cover to make sure that the o-ring seal is not visible.



TUNING ADJUSTMENTS

Adjustment procedures for alignment, spring rate, damping, steering, and ride height are covered here.

SUSPENSION TUNING

Springs

TRX-4's front spring (0.45 rate, no stripe) and rear spring (0.54 rate, green stripe) have been carefully selected to provide full suspension articulation and support for the weight of the vehicle body.

Using different bodies with lighter weight will allow you to use lower rate springs to increase traction and suspension articulation when traversing difficult terrain. Lighter springs can be used since the portal axles use gear reduction right at the wheels to reduce undesirable torque twist.

Ride Height Adjustment

TRX-4's ride height can be finely tuned by adjusting suspension sag via the preload adjusters on the shock bodies. Thread the preload adjuster down the shock body to raise TRX-4's ride height, or thread the adjuster up the shock body to lower ride height. The front left preload adjuster will require more threading to compensate for the weight of the motor. If threading the preload adjusters to the maximum ride height position still allows more suspension sag than you prefer, stiffer springs should be installed.

SHOCK TUNING

Shock Oil

The 4 oil-filled aluminum shocks (dampers) effectively control the suspension movement by preventing the wheels and tires from continuing to "bounce" after rebounding from a bump. Changing the oil in the shocks can vary the suspension damping effect. Changing the oil to a higher viscosity oil will increase damping. Lowering the viscosity of the oil will cause the suspension damping to be reduced.

Damping should be increased (with higher viscosity oil) if the model is bottoming easily over jumps or when stiffer springs are installed. Damping should be decreased (with thinner viscosity oil) if the model is hopping over small bumps and feels unstable or when softer springs are installed. The viscosity of shock oil is affected by extremes in operating temperature; an oil of certain viscosity will become less viscous at higher temperatures and more viscous at lower temperatures. Operating in regions with cold temperatures may require lower viscosity oil. From the factory, the shocks are filled with SAE-30W silicone oil. Only use 100% silicone oil in the shock.

Replacing Shock Oil

The shocks have to be removed from the vehicle and disassembled to change the oil.

1. Remove the lower spring retainer and shock spring.
2. Remove the upper shock cap.
3. Empty the used shock oil from the shock body.
4. Compress the shock fully against the stop on the lower spring retainer (A).
5. Fill the shock with new silicone shock oil up to the top of the shaft; then, add 2-3 drops of oil to reach the proper level (0.3mm above the top of the shaft) (B).
6. Slowly move the piston up and down to remove excess air. Add oil if needed to maintain the proper level.
7. Ensure the cavity in the upper shock cap (C) is dry and free of oil; screw the shock cap onto the shock body.
8. Tighten the shock cap until snug.

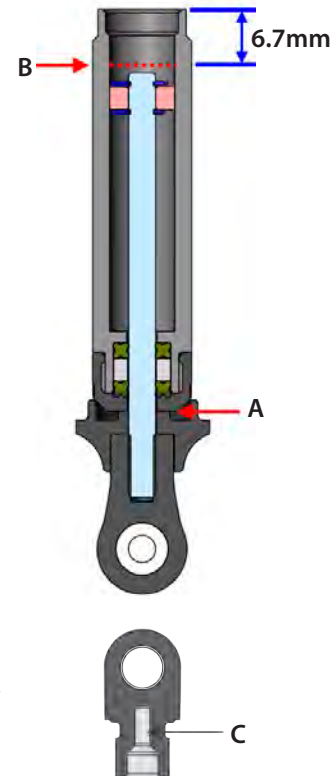

Shock disassembly

The shocks must be removed from the vehicle prior to disassembly. Use the shock exploded views included with the model to aid in the assembly process.

1. Remove the spring and lower spring retainer from the shock.
2. Remove the shock cap and empty the shock body of shock oil.
3. Remove the lower cap, the X-rings, and spacer from the shock body.
4. Use needlenose pliers or side cutters to grip the shock shaft just above the rod end. Remove the rod end from the shock shaft.
5. Remove the shock shaft with piston from the shock body out through the top of the shock body.



Important: The shocks are assembled at the factory with a center-to-center distance (between the rod end balls) of 90mm. Any time the shocks are removed and disassembled, this distance should be checked to ensure proper operation of the suspension.





Never slide the threads on the shock rod past the X-ring seals when it is installed and compressed by the bottom cap of the shock. Doing so will damage the seal and cause shock oil to leak.

Shock assembly

1. Insert the shock shaft assembly through the shock body until the piston bottoms out.
2. Lubricate the shaft, O-ring, and X-rings with silicone oil.
3. Install the O-ring, X-rings and spacer over the shaft and into the bore of the shock body.
4. Install the lower cap.
5. Grip the shaft close to the threads with needlenose pliers or side cutters and thread the rod end onto the shock shaft until the rod end bottoms out.
6. Fill the shock with new silicone shock oil (see the "Replacing Shock Oil" section on the previous page).
7. Slowly thread the upper cap onto the shock body.
8. Reinstall the spring and lower retainer.

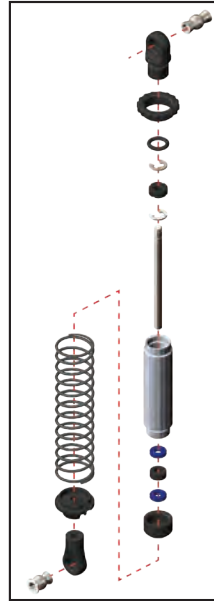

TRANSMISSION TUNING

Adjusting the Slipper Clutch

The TRX-4 is equipped with an adjustable Torque Control slipper clutch, which is built into the large spur gear. The purpose of the slipper clutch is to protect the motor and drivetrain when the drivetrain is bound while driving. The slipper clutch should not slip during normal operation.

The slipper clutch is integrated into the main spur gear on the transmission. The slipper clutch is adjusted using the locknut on the slipper shaft. To tighten or loosen the slipper nut, insert the 2.0mm hex wrench into the hole in the end of the slipper shaft. This locks the shaft for adjustments.

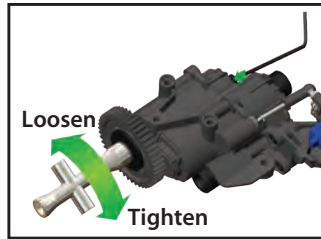

To restore factory settings, use the included 4-way wrench to turn the adjustment nut until all four spring washers are flat; then, tighten the nut an additional 1/16 turn (or until the slipper clutch does not allow the spur gear to slip during normal operation).

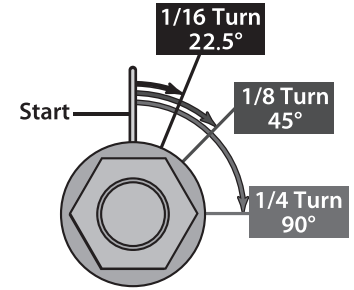

WHEELS AND TIRES

Many types of aftermarket tires and wheels can be adapted for use on your model. Most will affect the overall width and the suspension geometry of the model. The offsets and dimensions designed into the model's wheels are intentional; therefore, Traxxas cannot recommend the use of other non-Traxxas wheels with different specifications.

When selecting wheels, the inner diameter of the inside of the wheels must be 38mm or larger to accommodate the axle portals. The TRX-4's stub axles are 6mm; this may require drilling the center hole of the wheel to increase the diameter before it will fit. When selecting tires, consider the terrain. Rocky surfaces are better suited to soft compound tires with a tight tread pattern. In loose dirt, harder compound tires with a more open tread pattern should perform better. TRX-4's 1.9 Canyon Trail tires are optimized for all driving surfaces.

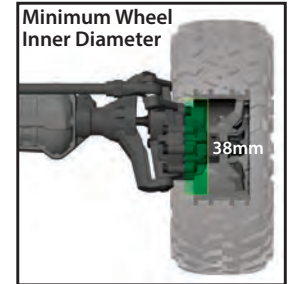

MOTORS AND GEARING

The TRX-4's Titan™ 550 Motor has been carefully matched to the needs of the TRX-4. The Titan 550 is made to run efficiently at high voltage to provide more torque and longer run times. We do not recommend converting the TRX-4 to a typical low-voltage setup using traditional 540 size motors. While these components will physically fit into the TRX-4, the system will not run as efficiently, losing power in the form of motor and battery heating. The result will be shorter run times, high current draw, and extreme battery and motor temperatures.

The TRX-4 is equipped from the factory with a 45-tooth spur gear and 11-tooth pinion gear. TRX-4 has a large range of gearing, making it suitable for many different types of applications and environments. If you want more acceleration and less top speed, use a smaller pinion gear (fewer teeth, higher numerical ratio). The overall reduction is the number of turns the motor makes for one revolution of the tire. Higher numerical ratios provide more torque, lower numerical ratios provide more top speed. **With the Titan 550 motor, do not use a pinion gear larger than 12-tooth with the stock 45-tooth spur gear.** Use the following formulas to calculate the overall ratio for combinations not listed on the gear chart:

To find High Gear :

$$\frac{\text{\# Spur Gear Teeth}}{\text{\# Pinion Gear Teeth}} \times 6.32 = \text{Final Gear Ratio}$$

To find Low Gear :

$$\frac{\text{\# Spur Gear Teeth}}{\text{\# Pinion Gear Teeth}} \times 15.8 = \text{Final Gear Ratio}$$

Gearing Compatibility Chart:

The charts below show a full range of gear combinations. This does NOT imply that these gear combinations should be used. Over-gearing (bigger pinions, smaller spurs) can overheat and damage the motor and/or speed control.

High Gear

	Spur Gear	
	39	45
9	-	31.60
10	-	28.44
11	-	25.85
12	-	23.70
13	-	21.88
14	-	20.31
15	16.43	18.96
16	15.41	17.78
17	14.50	-
18	13.69	-
19	12.97	-
20	12.32	-
21	11.74	-
22	11.20	-

Low Gear

	Spur Gear	
	39	45
9	-	79.00
10	-	71.10
11	-	64.64
12	-	59.25
13	-	54.69
14	-	50.79
15	41.08	47.40
16	38.51	44.44
17	36.25	-
18	34.23	-
19	32.43	-
20	30.81	-
21	29.34	-
22	28.01	-

- Stock factory gearing
- For 6- or 7-cell NiMH battery and 2s/3s LiPo battery
- Does not fit
- Not recommended for stock motor



Screw Positions

Spur Gear

Pinion Gear	Spur Gear	
	39	45
9	-	A
10	-	B
11	-	C
12	-	D
13	-	E
14	-	F
15	A	G
16	B	H
17	C	-
18	D	-
19	E	-
20	F	-
21	G	-
22	H	-

Stock factory gearing
 Does not fit

Adjusting Gear Mesh

Incorrect gear mesh is the most common cause of stripped spur gears. Your model includes a fixed gear positioning system to simplify the process and ensure proper gear mesh settings. Access the gears by removing the three 3x8mm button-head screws from the gear cover; remove the gear cover. Remove the motor/motor plate assembly from the chassis.



To set the gear mesh, use the chart to the left to identify the screw positions on the motor plate (A - H) that correspond with the chosen motor pinion (9-T - 22-T) and spur gear size (39-T or 45-T). Remove the two screws from the motor/motor plate and reinstall in the corresponding positions; reinstall the motor/motor plate assembly in the chassis.

Motor Removal/Installation

To access the motor, remove the gear cover by removing the three 3x8mm button-head cap screws. Remove the motor/motor plate assembly from the chassis; then, remove the two screws holding the motor to the motor plate. Installation of the motor is the reverse of removal.

SERVO STEERING SYSTEM

TRX-4 uses a single metal gear servo for powerful, responsive steering.

Adjusting the Steering System

1. Remove the servo horn and steering links from the servo.
2. Adjust the drag link to 133.2mm; adjust the steering link to 77.3mm.

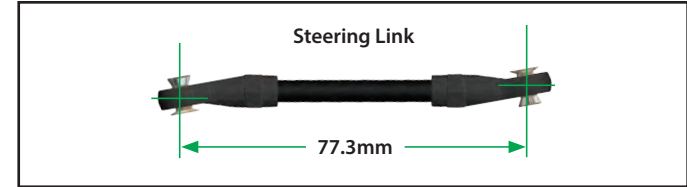
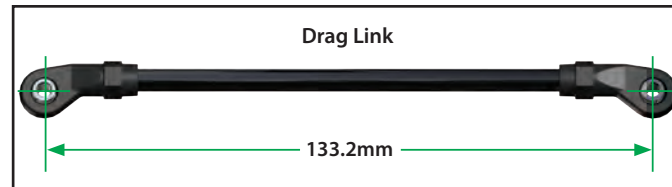

3. Switch on the power to the receiver and the transmitter.
4. Adjust the steering trim on the transmitter to the neutral "0" position.
5. Connect one end of a steering link to the steering servo arm and the other end to the servo horn.
6. Position the servo horn perpendicular to the centerline of the vehicle as shown below.

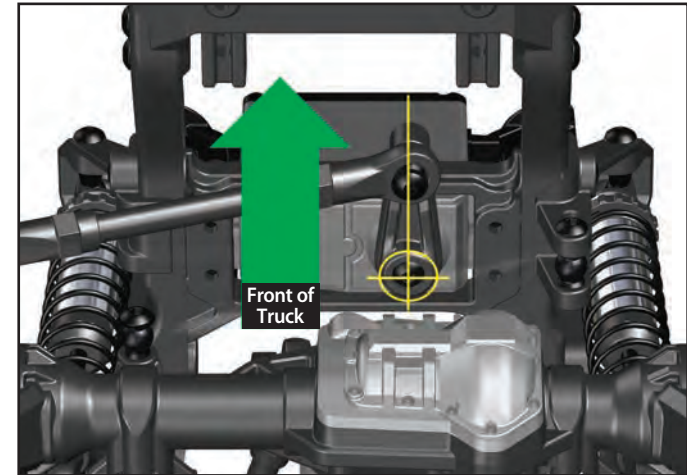

If you are using aftermarket servos, it is important to use servo horns designed for TRX-4. The servo horns must measure 22mm from the steering linkage mounting hole to the servo mounting hole.

T-LOCK SERVO INSTALLATION

The TRX-4's T-Lock differential control servos are installed and pre-set at the factory. If you need to remove the servos or the servo horns for maintenance or cleaning, carefully note their orientation when you reinstall them to make certain the T-Lock system operates properly.

Before reinstalling the spring-loaded servo horns, reset the servos' output shafts to the "diffs open" position.

1. Switch the transmitter and receiver on and plug the T-Lock servos into their correct positions on the receiver unit (see page 12).
2. Operate the transmitter's T-Lock switch to make certain both servos operate properly, then place the switch in the "open" position for unlocked front and rear diffs (see page 21).
3. Install the servo horns as shown below. Switch the transmitter and on-board electronics off before completing the installation.

Front Differential T-Lock Servo

Differential Open: Install the spring-loaded servo horn so the spring slot is perpendicular to the linkage as shown.

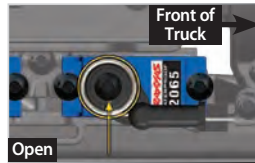

Differential Locked: Switch the transmitter and receiver on. Move the T-Lock switch to the middle position to lock the front differential. Confirm that the servo's output shaft turns counterclockwise to rotate the servo horn to the position shown.

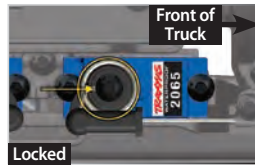

Rear Differential T-Lock Servo

Differential Open: Install the spring-loaded servo horn so the spring slot is parallel to the linkage as shown.



Differential Locked: Switch the transmitter and receiver on. Move the T-Lock switch to the forward-most position to lock the rear differential. Confirm that the servo's output shaft turns counterclockwise to rotate the servo horn to the position shown.



FITTING AFTERMARKET BODIES

Rear Shock Tower

The rear shock tower can be installed in two different locations and in two orientations each. This is to allow precise angle adjustment of the rear shocks. The shock cap hollow balls can also be replaced with offset versions (part #5355, sold separately) to further fine tune the shock angle.

Rear Body Mount

An additional rear body mount crossmember is included with your model to allow the rear shock towers to be installed in the forward position.

MAINTAINING YOUR MODEL



Always wear eye protection when using compressed air or spray cleaners and lubricants.

Your model requires timely maintenance in order to stay in top running condition. **The following procedures should be taken very seriously.**

Inspect the vehicle for obvious damage or wear. Look for:

1. Cracked, bent, or damaged parts
2. Check the wheels and steering for binding.
3. Check the operation of the shock absorbers.
4. Check the wiring for any frayed wires or loose connections.
5. Check the mounting of the receiver and servo(s) and speed control.
6. Check the tightness of the wheel nuts with a wrench.
7. Check the operation of the radio system, especially the condition of the batteries.
8. Check for any loose screws in the chassis structure or suspension.
9. Inspect the gears for wear, broken teeth, or debris lodged between the teeth.
10. Check the tightness of the slipper clutch.

Other periodic maintenance:

• Slipper clutch pads (friction material):

Under normal use, the friction material in the slipper clutch should wear very slowly. If the thickness of any one of the slipper clutch pads is 0.35mm or less, the friction disc should be replaced. Measure the pad thickness using calipers.



- **Chassis:** Keep the chassis clean of accumulated dirt and grime. Periodically inspect the chassis for damage.
- **Motor:** Every 10-15 runs, remove, clean, and lubricate the motor. Use a product such as electric motor cleaning spray to flush dirt out of the motor. After cleaning, lubricate the bushings at each end of the motor with a drop of light-weight electric motor oil.

- **Shocks:** Keep the oil level in the shocks full. Use only 100% pure silicone shock oil to prolong the life of the seals. If you are experiencing leakage around the top of the shock, inspect the o-ring in the top cap for signs of damage or distortion from overtightening. If the bottom of the shock is leaking, then it is time for a rebuild. The Traxxas rebuild kit for two shocks is part #8262.
- **Suspension:** Periodically inspect the model for signs of damage, such as bent rod ends, bent linkage rods, bent shock shafts, loose screws, or any signs of stress or bending. Replace components as needed.
- **Driveline:** Inspect the driveline for signs of wear such as worn, dirty or corroded center drive shafts, dirty constant-velocity driveshaft joints (center and front), and any unusual noise or binding. Do not allow dirt and grime to collect in the drive cups. After cleaning, lubricate the pins and cross pins with a drop of light-weight machine oil. **DO NOT** use too much oil to avoid build-up of dust and dirt. Remove the gear cover. Inspect the spur gear for wear and check the tightness of the set screw in the pinion gear. Tighten, clean, or replace components as needed.

Storage

When you are through running the model for the day, blow it off with compressed air or use a soft bristled paint brush to dust-off the vehicle. Always disconnect and remove the batteries from the model whenever the model is stored. If the model will be stored for a long time, then also remove the batteries from the transmitter.

If you have questions or need technical assistance, call Traxxas at

1-888-TRAXXAS

(1-888-872-9927) (U.S. residents only)



Your Traxxas transmitter has a programmable Multi-Function knob that can be set to control various advanced transmitter functions (set to Cruise Control by default, see page 17). Accessing the programming menu is done by using the menu and set buttons on the transmitter and observing signals from the LED. An explanation of the menu structure follows on page 34. Experiment with the settings and features to see if they can improve your driving experience.

Steering Sensitivity (Exponential)

The Multi-Function knob on the TQi transmitter can be programmed to control Steering Sensitivity (also known as exponential). The standard setting for Steering Sensitivity is “normal (zero exponential),” with the dial full left in its range of travel. This setting provides linear servo response: the steering servo’s movement will correspond exactly with the input from the transmitter’s steering wheel. Turning the knob clockwise from center will result in “negative exponential” and decrease steering sensitivity by making the servo less responsive near neutral, with increasing sensitivity as the servo nears the limits of its travel range. The farther you turn the knob, the more pronounced the change in steering servo movement will be. The term “exponential” comes from this effect; the servo’s travel changes exponentially relative to the input from the steering wheel. The exponential effect is indicated as a percentage—the greater the percentage, the greater the effect. The illustrations below show how this works.

Normal Steering Sensitivity (0% exponential):

In this illustration, the steering servo’s travel (and with it, the steering motion of the model’s front wheels) corresponds precisely with the steering wheel. The ranges are exaggerated for illustrative purposes.

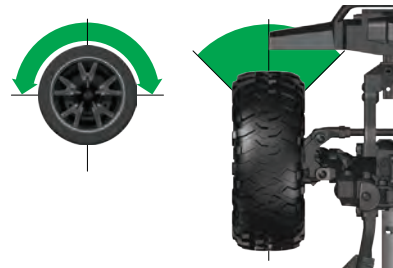

Decreased Steering Sensitivity (Negative Exponential):

By turning the Multi-Function knob clockwise, the steering sensitivity of the model will be decreased. Note that a relatively large amount of steering wheel travel results in a smaller amount of servo travel. The farther you turn the knob, the more pronounced the effect becomes. Decreased steering sensitivity may be helpful when driving on low-traction surfaces and when driving at high speed. The ranges are exaggerated for illustrative purposes.

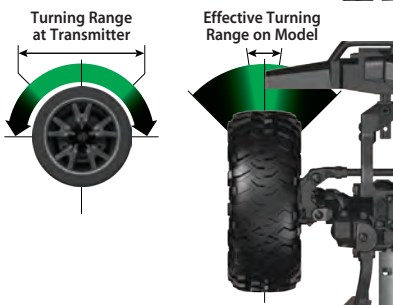

Throttle Sensitivity (Throttle Exponential)

The Multi-Function knob can be set to control Throttle Sensitivity. Throttle Sensitivity works the same way as Steering Sensitivity, but applies the effect to the throttle channel. Only forward throttle is affected; brake/reverse travel remains linear regardless of the Throttle Sensitivity setting.

Steering Percentage (Dual-Rate)

The Multi-Function knob can be set to control the amount (percentage) of servo travel applied to steering. Turning the Multi-Function knob fully clockwise will deliver maximum steering throw; turning the knob counterclockwise reduces steering throw (**Note: turning the dial counterclockwise to its stop will eliminate all servo travel**). Be aware that the steering End Point settings define the servo’s maximum steering throw. If you set Steering Percentage to 100% (by turning the Multi-Function knob fully clockwise), the servo will travel all the way to its selected end point, but not past it. Many racers set Dual-Rate so they have only as much steering throw as they need for the track’s tightest turn, thus making the model easier to drive throughout the rest of the course. Reducing steering throw can also be useful in making a model easier to control on high-traction surfaces, and limiting steering output for oval racing where large amounts of steering travel are not required.

Braking Percentage

The Multi-Function knob may also be set to control the amount of brake travel applied by the servo in a nitro-powered model. Electric models do not have a servo-operated brake, but the Braking Percentage function still operates the same way in electric models. Turning the Multi-Function knob full clockwise will deliver maximum brake throw; turning the knob counterclockwise reduces brake throw (**Note: Turning the dial counterclockwise to its stop will eliminate all brake action**).

Throttle Trim

Setting the Multi-Function knob to serve as throttle trim will allow you to adjust the throttle’s neutral position to prevent unwanted brake drag or throttle application when the transmitter trigger is at neutral. **Note:** Your transmitter is equipped with a Throttle Trim Seek Mode to prevent accidental runaways. See the sidebar for more information.

Traxxas Stability Management (TSM)

The Multi-Function knob on the TQi transmitter can be programmed to control Traxxas Stability Management or TSM. TSM allows you to experience all the speed and acceleration that was engineered into your Traxxas model by helping you to maintain control of the vehicle in low-traction situations or over rough terrain. TSM also dramatically improves braking control and makes corrections for you, without intruding on your fun, or creating unexpected side effects.



Starting Over: Restoring Factory Defaults

When programming your TQi transmitter, you may feel the need to start over with a clean slate. Follow these simple steps to restore the factory settings:

1. Turn the transmitter off.
2. Hold both MENU and SET.
3. Turn the transmitter on.
4. Release MENU and SET.
The transmitter LED will blink red.
5. Press MENU 6 times. The transmitter LED will blink red 7 times repeatedly.
6. Press SET to clear settings.
The LED will turn solid green and the transmitter is restored to default.



Failsafe

Your Traxxas radio system is equipped with a built-in failsafe function that returns the throttle to its last saved neutral position in the event of a signal loss. The LED on the transmitter and on the receiver will rapidly flash red.

In order to re-acquire the signal after the failsafe has activated, you will need to walk a longer distance closer to the model than the distance the model travelled out of range. Simply keep walking towards the model until you re-acquire the signal.



Throttle Trim Seek Mode

When the Multi-Function knob is set to throttle trim, the transmitter remembers the throttle trim setting. If the throttle trim knob (Multi-Function knob) is moved from the original setting while the transmitter is off, or while the transmitter was used to control another model, the transmitter ignores the actual position of the trim knob. This prevents the model from accidentally running away. The LED on the face of the transmitter will rapidly blink green and the throttle trim knob (Multi-Function knob) will not adjust the trim until it is moved back to its original position saved in memory. To restore throttle trim control, simply turn the Multi-Function knob either direction until the LED stops blinking.

The recommended (default) setting for TSM is to rotate the knob to the 12:00 position (the zero mark on the dial).

Turn the knob clockwise to increase assistance; turn the knob counterclockwise to decrease assistance. Turn the knob counterclockwise to its stop to turn TSM completely off.

Note: TSM is deactivated automatically when driving or braking in reverse.

When driving on surfaces with some traction, decrease the TSM setting to allow the vehicle to feel more “loose”. On surfaces with very little traction (loose dirt, smooth concrete, ice/snow), increase TSM to maximize acceleration and control. TSM should be disabled when precise wheel placement is needed, such as during rock crawling or scaling extreme terrain.

Note: TSM must be completely turned off while adjusting steering trim.



Steering and Throttle End Points

The TQi transmitter allows you to choose the limit of the servo’s travel range (or its “end point”) independently for left and right travel (on the steering channel) and throttle/brake travel (on the throttle channel). This allows you to fine-tune the servo settings to prevent binding caused by the servo moving steering or throttle linkages (in the case of a nitro model) farther than their mechanical limits. The end point adjustment settings you select will represent what you wish to be the servo’s maximum travel; the Steering Percentage or Braking Percentage functions will not override the End Point settings.

Steering and Throttle Sub-Trim

The Sub-Trim function is used to precisely set the neutral point of the steering or throttle servo in the event that simply setting the trim knob to “zero” does not completely center the servo. When selected, Sub-Trim allows finer adjustment to the servo output shaft’s position for precise setting of the neutral point. Always set the Steering Trim knob to zero before making final adjustment (if required) using Sub-Trim. If Throttle Trim has been previously adjusted, the Throttle Trim will need to be reprogrammed to “zero” before making final adjustment using Sub-Trim.

TRANSMITTER LED CODES

LED Color / Pattern	Name	Notes	
●	Solid green	Normal Driving Mode	See page 15 for information on how to use your transmitter controls.
⚙️	Slow red (0.5 sec on / 0.5 sec off)	Binding	See page 17 for more information on binding.
🌟🌟	Flashing fast green (0.1 sec on / 0.15 sec off)	Throttle Trim Seek Mode	Turn the Multi-Function knob right or left until the LED stops flashing. See the sidebar for more information.
🌟	Flashing medium red (0.25 sec on / 0.25 sec off)	Low Battery Alarm	Put new batteries in the transmitter. See page 13 for more information.
🌟🌟	Flashing fast red (0.125 sec on / 0.125 sec off)	Link Failure / Error	Transmitter and receiver are no longer bound. Turn the system off and then back on to resume normal operation. Find source of the link failure (i.e., out of range, low batteries, damaged antenna).
Programming Patterns			
🌟 or 🌟	Counts out number (green or red), then pauses	Current menu position	See Menu Tree for more information.
🌟 x8	Fast green 8 times	Menu setting accepted (on SET)	
🌟 x8	Fast red 8 times	Menu SET invalid	User error, such as trying to delete a locked model.

RECEIVER LED CODES

LED Color / Pattern	Name	Notes	
●	Solid green	Normal Driving Mode	See page 15 for information on how to use your transmitter controls.
⚙️	Slow red (0.5 sec on / 0.5 sec off)	Binding	See page 17 for more information on binding.
🌟🌟	Flashing fast red (0.125 sec on / 0.125 sec off)	Fail-Safe / Low Voltage Detect	Consistent low voltage in the receiver triggers Fail-Safe so there is enough power to center the throttle servo before it completely loses power.

Setting Lock

Once you've adjusted all of these settings the way you like them, you may want to disable the Multi-Function knob so none of your settings can be changed. This is especially handy if you operate multiple vehicles with a single transmitter via Traxxas Link™ Model Memory.

Multiple Settings and the Multi-Function Knob

It is important to note that settings made with the Multi-Function knob are "overlaid" on top of each other. For example, if you assign the Multi-Function to adjust Steering Percentage and set it for 50%, then reassign the knob to control Steering Sensitivity, the transmitter will "remember" the Steering Percentage setting. Adjustments you make to Steering Sensitivity will be applied to the 50% steering throw setting you selected previously. Likewise, setting the Multi-Function knob to "disabled" will prevent the knob from making further adjustments, but the last setting of the Multi-Function knob will still apply.

TRAXXAS LINK MODEL MEMORY

Traxxas Link Model Memory is an exclusive, patent-pending feature of the TQi transmitter. Each time the transmitter is bound to a new receiver, it saves that receiver in its memory, along with all the settings assigned to that receiver. When the transmitter and any bound receiver are switched on, the transmitter automatically recalls the settings for that receiver. There is no need to manually select your vehicle from a list of model memory entries.

Model Lock

The Traxxas Link Model Memory feature can store up to thirty models (receivers) in its memory. If you bind a thirty-first receiver, Traxxas Link Model Memory will delete the "oldest" receiver from its memory (in other words, the model you used the longest time ago will be deleted). Activating Model Lock will lock the receiver in memory so it cannot be deleted.

You may also bind multiple TQi transmitters to the same model, making it possible to pick up any transmitter and any previously bound model in your collection and simply turn them on and drive. With Traxxas Link Model Memory, there is no need to remember which transmitter goes with which model, and there is never a need to have to select any model from a list of model memory entries. The transmitter and receiver do it all for you automatically.

To activate Model Lock:

1. Switch on the transmitter and receiver you wish to lock.
2. Press and hold MENU. Release when the status LED blinks green.
3. Press MENU three times. The status LED will blink green four times repeatedly.
4. Press SET. The status LED will blink green in single-flash intervals.
5. Press SET once. The status LED will blink red once repeatedly.
6. Press MENU once. The status LED will blink red twice repeatedly.
7. Press SET. The LED will blink rapidly green. The memory is now locked. Press and hold MENU to return to driving mode.

Note: To unlock a memory, press SET twice at step 5. The LED will blink rapidly green to indicate the model is unlocked. To unlock all models, press MENU twice at step 6 and then press SET.

To delete a model:

At some point, you may wish to delete a model you no-longer drive from the memory.

1. Switch on the transmitter and receiver you wish to delete.
2. Press and hold MENU. Release when the status LED blinks green.
3. Press MENU three times. The status LED will blink green four times repeatedly.
4. Press SET once. The status LED will blink green once repeatedly.
5. Press MENU once. The status LED will blink green twice repeatedly.
6. Press SET. The memory is now selected to be deleted. Press SET to delete the model. Press and hold MENU to return to driving mode.

MENU TREE

The Menu Tree below shows how to navigate through the TQi transmitter's various settings and functions. Press and hold MENU to enter the Menu Tree, and use the following commands to navigate through the menu and select options.

MENU: When you enter a menu, you always start at the top. Press MENU to move down the Menu Tree. When you reach the bottom of the tree, pressing MENU again will return you to the top.

SET: Press SET to move across the Menu Tree and select options. When an option is committed to the transmitter's memory, the status LED will rapidly blink green.

BACK: Press both MENU and SET to go back one level in the Menu Tree.

EXIT: Press and hold MENU to exit programming. Your selected options will be saved.

ECHO: Press and hold SET to activate the "echo" function. Echo will "play back" your current position on the Menu Tree should you lose your place. For example: If your current position is Steering Channel End Points, holding SET will cause the LED to blink green twice, green once, and then red three times. Echo will not alter your adjustments or change your position in the programming sequence.

Below is an example of how to access a function in the Menu Tree. In the example, the user is setting the Multi-Function knob to be a Steering % (Dual-Rate) control.

- To set the Multi-Function knob to control STEERING % (DUAL-RATE):
1. Switch the transmitter on.
 2. Press and hold MENU until the green LED lights. It will blink in single intervals.
 3. Press SET. The red LED will blink in single intervals to indicate Steering Sensitivity (Expo) has been selected.
 4. Press MENU twice. The red LED will blink three times repeatedly to indicate Steering % (Dual-Rate) has been selected.
 5. Press SET to select. The green LED will blink 8 times fast to indicate successful selection.
 6. Press and hold MENU to return to driving mode.

Restoring Factory Defaults:

Transmitter OFF	Hold both MENU and SET	Transmitter ON	Release MENU and SET red LED blinks	Press MENU 6 times Red LED blinks 7 times repeatedly	Press SET to clear settings LED will turn solid green Transmitter is restored to default
-----------------	------------------------	----------------	--	--	--

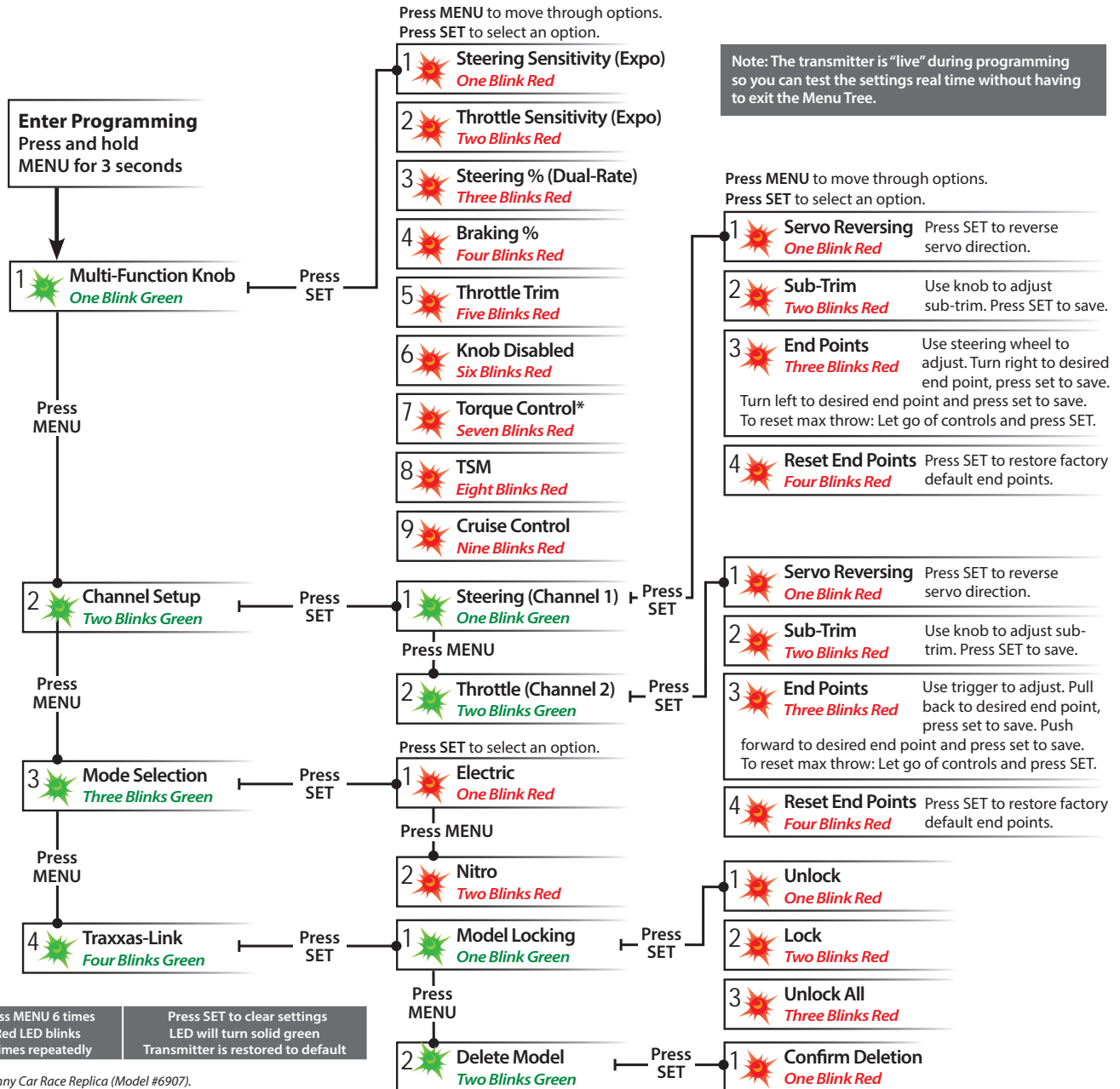

*Torque Control is a feature designed only for use with the power system in the Traxxas Funny Car Race Replica (Model #6907).

Set Multi-Function knob for STEERING SENSITIVITY (Expo)	Press/hold MENU green LED blinks	Press SET red LED blinks	Press SET to confirm green LED blinks (x8)	Press/hold MENU returns to driving mode							
Set Multi-Function knob for THROTTLE SENSITIVITY (Expo)	Press/hold MENU green LED blinks	Press SET red LED blinks	Press MENU to confirm red LED blinks (x2)	Press SET to select green LED blinks (x8)	Press/hold MENU returns to driving mode						
Set Multi-Function knob for STEERING (%)/DUAL-RATE	Press/hold MENU green LED blinks	Press SET red LED blinks	Press MENU twice red LED blinks (x3)	Press SET to select green LED blinks (x8)	Press/hold MENU returns to driving mode						
Set Multi-Function knob for BRAKING PERCENTAGE (%)	Press/hold MENU green LED blinks	Press SET red LED blinks	Press MENU 3 times red LED blinks (x4)	Press SET to select green LED blinks (x8)	Press/hold MENU returns to driving mode						
Set Multi-Function knob for THROTTLE TRIM	Press/hold MENU green LED blinks	Press SET red LED blinks	Press MENU 4 times red LED blinks (x5)	Press SET to select green LED blinks (x8)	Press/hold MENU returns to driving mode	Adjust the Multi-Function knob until the LED turns solid green.					
To LOCK the Multi-Function knob	Press/hold MENU green LED blinks	Press SET red LED blinks	Press MENU 5 times red LED blinks (x6)	Press SET to lock green LED blinks (x8)	Press/hold MENU returns to driving mode						
Set Multi-Function knob for TORQUE CONTROL*	Press/hold MENU green LED blinks	Press SET red LED blinks	Press MENU 6 times red LED blinks (x7)	Press SET to select green LED blinks (x8)	Press/hold MENU returns to driving mode						
Set Multi-Function knob for TSM	Press/hold MENU green LED blinks	Press SET red LED blinks	Press MENU 7 times red LED blinks (x8)	Press SET to select green LED blinks (x8)	Press/hold MENU returns to driving mode						
Set Multi-Function knob for CRUISE CONTROL	Press/hold MENU green LED blinks	Press SET red LED blinks	Press MENU 8 times red LED blinks (x9)	Press SET to select green LED blinks (x8)	Press/hold MENU returns to driving mode						
To REVERSE the direction of STEERING servo	Press/hold MENU green LED blinks	Press MENU green LED blinks (x2)	Press SET green LED blinks	Press SET red LED blinks	Press SET to reverse servo direction	Press/hold MENU returns to driving mode					
To set the SUB TRIM of the STEERING servo	Press/hold MENU green LED blinks	Press MENU green LED blinks (x2)	Press SET green LED blinks	Press SET red LED blinks	Press MENU red LED blinks (x2)	Use Multi-Function knob to set neutral	Press SET to save position	Press/hold MENU returns to driving mode			
To set the END POINTS of the STEERING servo	Press/hold MENU green LED blinks	Press MENU green LED blinks (x2)	Press SET green LED blinks	Press SET red LED blinks	Press MENU twice red LED blinks (x3)	Turn steering wheel to desired max left and right travel	Press SET to save each position	Turn steering wheel to test settings	IF END POINTS ARE OK: Press/hold MENU returns to driving mode	IF END POINTS NEED TO BE CHANGED: Press SET and repeat steps 6-8	
To reset the END POINTS of STEERING servo to defaults	Press/hold MENU green LED blinks	Press MENU green LED blinks (x2)	Press SET green LED blinks	Press SET red LED blinks	Press MENU 3 times red LED blinks (x4)	Press SET to reset end points	Press/hold MENU returns to driving mode				
To REVERSE the direction of THROTTLE servo	Press/hold MENU green LED blinks	Press MENU green LED blinks (x2)	Press SET green LED blinks	Press MENU green LED blinks (x2)	Press SET red LED blinks	Press SET to reverse servo direction	Press/hold MENU returns to driving mode				
To set the SUB TRIM of the THROTTLE servo	Press/hold MENU green LED blinks	Press MENU green LED blinks (x2)	Press SET green LED blinks	Press MENU green LED blinks (x2)	Press SET red LED blinks	Press MENU red LED blinks (x2)	Use Multi-Function knob to set neutral	Press SET to save position	Press/hold MENU returns to driving mode		
To set the END POINTS of the THROTTLE servo	Press/hold MENU green LED blinks	Press MENU green LED blinks (x2)	Press SET green LED blinks	Press MENU green LED blinks (x2)	Press SET red LED blinks	Press MENU twice red LED blinks (x3)	Use throttle trigger to set desired max throttle or brake	Press SET to save	Use trigger to test	IF END POINTS ARE OK: Press/hold MENU returns to driving mode	IF END POINTS NEED TO BE CHANGED: Press SET and repeat steps 7-9
To reset the END POINTS of THROTTLE servo to defaults	Press/hold MENU green LED blinks	Press MENU green LED blinks (x2)	Press SET green LED blinks	Press MENU green LED blinks (x2)	Press SET red LED blinks	Press MENU 3 times red LED blinks (x4)	Press SET green LED blinks (x8)	Press/hold MENU returns to driving mode			
To REVERSE the direction of SHIFT servo	Press/hold MENU green LED blinks	Press MENU green LED blinks (x2)	Press SET green LED blinks	Press MENU twice green LED blinks (x3)	Press SET red LED blinks	Press SET to reverse servo direction	Press/hold MENU returns to driving mode				

MENU TREE FORMULAS

To select functions and make adjustments to the TQi transmitter without referencing the Menu Tree, turn your transmitter on, find the function in the left column you wish to adjust, and simply follow the corresponding steps.



Always turn your transmitter on first.

*Torque Control is a feature designed only for use with the power system in the Traxxas Funny Car Race Replica (Model #6907).



The Traxxas Link Wireless Module is sold separately (part #6511). The Traxxas Link application is available from the Apple App store for iPhone, iPad, or iPod touch and on Google Play for Android devices. iPhone, iPad, iPod touch, or the Android device are not included with the Traxxas Link Wireless Module.

For more information about the Traxxas Link Wireless Module and the Traxxas Link application, visit Traxxas.com.

PROGRAMMING YOUR TQi TRANSMITTER WITH YOUR APPLE IPHONE, IPAD, IPOD TOUCH, OR ANDROID MOBILE DEVICE

The Traxxas Link™ Wireless Module (part #6511, sold separately) for the TQi transmitter installs in minutes to transform your Apple® iPhone®, iPad®, iPod touch®, or Android™ device into a powerful tuning tool that allows you to replace the transmitter's button/LED programming system with an intuitive, high-definition, full-color graphical user interface.



Traxxas Link

The powerful Traxxas Link app (available in the Apple App Store™ or on Google Play™) gives you complete control over the operation and tuning of your Traxxas model with stunning visuals and absolute precision. Install Traxxas Link telemetry sensors on the model, and Traxxas Link displays real-time data such as speed, RPM, temperature, and battery voltage.



Compatible with:
iPod touch (5th generation and later)
iPad mini
iPad Pro

iPad 2
iPad Air
iPhone 4s (and later)
Android 4.4 (and later)

Intuitive iPhone, iPad, iPod touch, and Android interface Traxxas Link makes it easy to learn, understand, and access powerful tuning options. Control Drive Effects settings such as steering and throttle sensitivity; steering percentage; braking strength; and throttle trim by simply touching and dragging the sliders on the screen.



Tap and slide to adjust Steering Sensitivity, Throttle Trim, Braking Percent, and more!

Real-Time Telemetry

When you equip your model with sensors, the Traxxas Link dashboard comes to life showing you speed, battery voltage, RPM, and temperature. Set threshold warnings and log maximums, minimums, or averages. Use the recording function to document your dashboard view, with sound, so that you can keep your eyes on your driving and not miss a single apex.



The customizable Traxxas Link dashboard delivers real-time rpm, speed, temperature, and voltage data.

Manage up to 30 Models with Traxxas Link

The TQi radio system automatically keeps track of what vehicles it has bound to and what settings were used for each—up to 30 models total! Traxxas Link provides a visual interface to name the models, customize their settings, attach profiles, and lock them into memory. Simply choose a model and any previously bound transmitter, power them up, and start having fun.



Traxxas Link Model Memory simplifies organizing your collection of vehicles.





A scenic mountain landscape with a lake and a TRX4 crawler vehicle. The background features snow-capped mountains, green slopes, and a clear blue sky. In the foreground, a calm lake reflects the surrounding scenery. A TRX4 crawler vehicle is partially visible on the right side of the lake.

TRX4

Scale and Trail

Crawler

OWNER'S MANUAL

MODEL 82056-4

TRAXXAS

6250 TRAXXAS WAY MCKINNEY, TEXAS 75070

1-888-TRAXXAS