

RunCam Swift 2

USER MANUAL

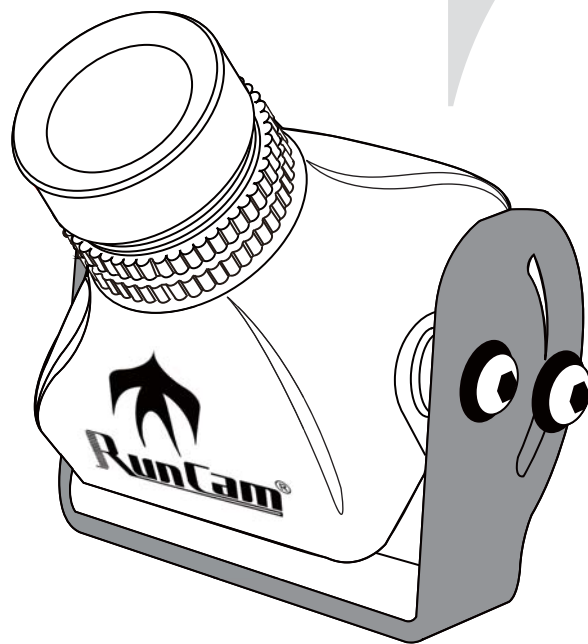

Connection

* Unplug the 5D-OSD menu cable after OSD setting.

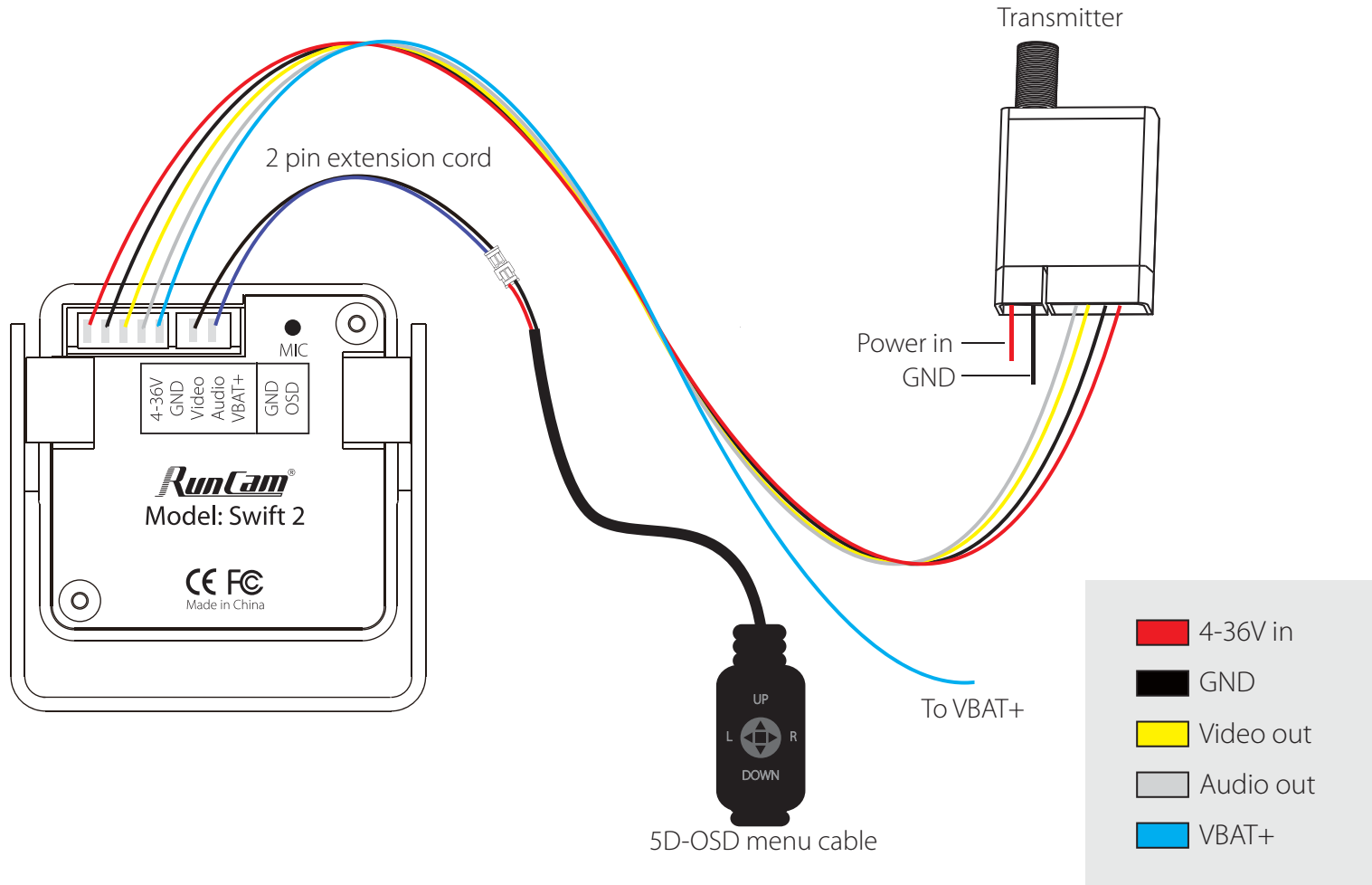

Dimensions & Installation

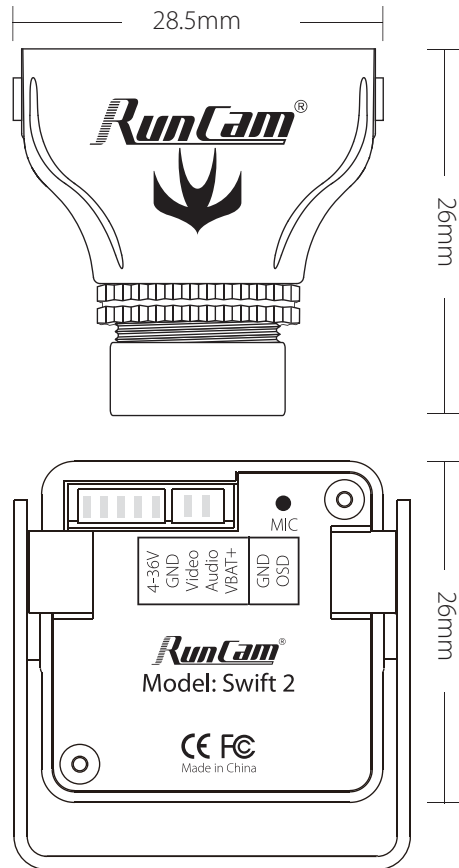

- 1 Nylon Gaskets
- 2 M2*4 Screws
- 3 M3*5 Screws
- 4 M3 Non-slip Nuts

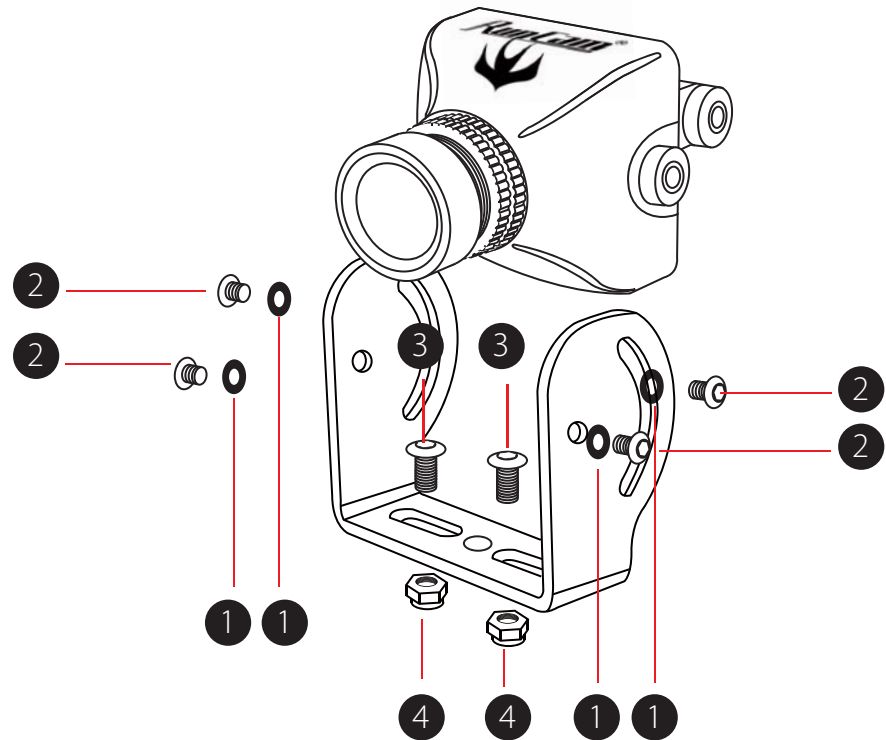

OSD Menu

OSD Setting: Press and hold the UP button for 2 seconds to enter OSD setup menu.

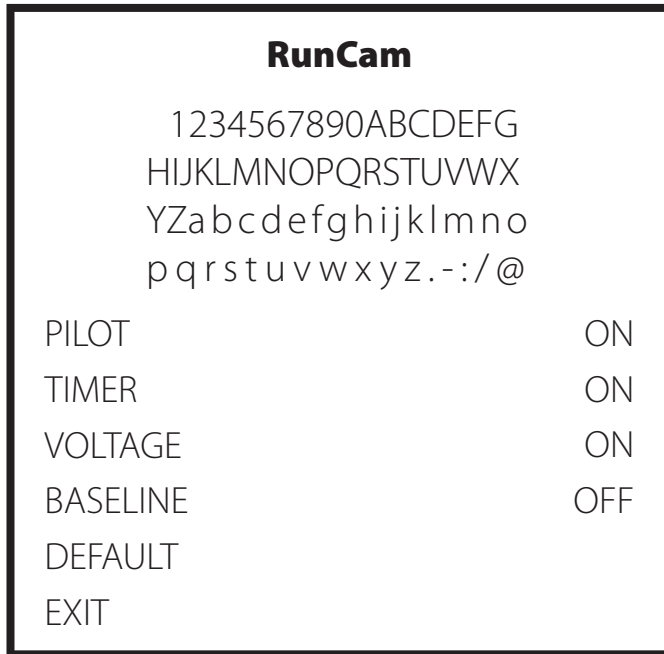

- PILOT: ON/OFF
- TIMER: ON/OFF
- VOLTAGE: ON/OFF
- BASELINE: OFF/1-9
- EXIT: Save the current settings and exit

Customize the PILOT name: Use the UP, DOWN, LEFT and RIGHT buttons to navigate through the letters and confirm with the CENTER button.

Quick settings:

Long press the LEFT/DOWN/RIGHT button for 2 seconds to activate the VOLTAGE/PILOT /TIMER, then you can use the UP, DOWN, LEFT and RIGHT buttons to move it to the appropriate location on the screen, and press the CENTER button to exit.

The OSD displays by default the input voltage of the camera. If the VBAT + cable is connected to the battery's positive side, it displays the battery voltage instead.

Camera Menu

- MAIN MENU

SETUP	
CAM TITLE	OFF ↵
EXPOSURE	↵
BACKLIGHT	↵
WHITE BAL	ATW1
DAY & NIGHT	COLOR ↵
IMAGE ADJ	↵
DPC	↵
LANGUAGE	ENGLISH
RESET	↵
EXIT	

- CAM TITLE (ON/OFF)
- LANGUAGE (English/中文)
- WHITE BAL (ATW1 / ATW2 / AWC→ SET / MANUAL: MANUAL, INDOOR, OUTDOOR)
- DPC (Cover the lens then press enter key)

- EXPOSURE

EXPOSURE	
SHUTTER	AUTO
BRIGHTNESS 050
AGC	OFF
DWDR	ON ↵
RETURN	RET ↵

- SHUTTER (AUTO / 50-100000 / FLK)
- BRIGHTNESS (50 / 0-255)
- AGC (OFF / LOW / MIDDLE / HIGH)
- DWDR (ON: 63 0-63 / OFF)

Camera Menu

- IMAGE ADJ

IMAGE ADJ		
LENS SHAD		OFF
2DNR		OFF
MIRROR		OFF
FONT COLOR		←
CONTRAST	110
SHARPNESS	026
DISPLAY		USER ←
NEG IMAGE		OFF
RETURN		

- LENS SHAD (OFF/ ON:22 0-255)
- CONTRAST (110 / 0-255)
- SHARPNESS (26 / 0-31)
- DISPLAY (CRT/LCD/USER)

USER ADJ.		
GAMMA		0.50
PED LEVEL	017
COLOR GAIN	176
RETURN		RET ←

- GAMMA (0.5 / 0.05-1.0)
- PED LEVEL (17 / 0-63)
- COLOR GAIN (176 / 0-255)

Camera Menu

- BACKLIGHT (BLC / HLC / OFF)

BLC		
AREA SEL		AREA1
AREA STATE		ON
GAIN	042
HEIGHT	004
WIDTH	003
LEFT/RIGHT	006
TOP/BOTTOM	005
RETURN		RET ↵



- AREA SEL (AREA1/AREA2)
- GAIN (042 / 0-255)
- HEIGHT (4 / 0-10)
- WIDTH (3 / 0-9)
- LEFT/RIGHT (6 / 0-6)
- TOP/BOTTOM (10 / 0-10)

HLC		
LEVEL	200
MODE		ALL DAY
RETURN		RET ↵

- LEVEL (200 / 0-255)
- MODE (ALL DAY / NIGHT ONLY)

Camera Menu

- DAY & NIGHT (AUTO / COLOR / B&W / EXT)

D & N AUTO		
D → N LEVEL		080
D → N DELAY	3	SEC
N → D LEVEL		032
N → D DELAY	1	SEC
RETURN		RET ↵

- DAY → NIGHT LEVEL (80 / 0-176)
- DAY → NIGHT DELAY (3 / 1-30)
- NIGHT → DAY LEVEL (032 / 0-255)
- NIGHT → DAY DELAY (1 / 1-30)

D & N B & W	
BURST	OFF
IR SMART	OFF
IR LEVEL	HIGH
RETURN	RET ↵

- BURST (OFF/ON)
- IR SMART (OFF/ON)
- IR LEVEL (HIGH/LOW)

<i>Model</i>	<i>RunCam Swift 2</i>
Image Sensor	1/3" SONY SUPER HAD II CCD
Horizontal Resolution	600TVL
Lens	2.5mm (Default) / 2.3mm / 2.1mm
Signal System	PAL/NTSC
Integrated OSD	Yes
Integrated MIC	Yes
S/N Ratio	>60dB (AGC OFF)
Electronic Shutter Speed	PAL: 1/50~100,000; NTSC: 1/60~100,000
Auto Gain Control (AGC)	Yes
Back Light Compensation (BLC)	Yes
Min. Illumination	0.01Lux@1.2F
WDR	D-WDR
DNR	2DNR
Day/Night	Color/Auto/B&W
Power	DC 4-36V
Net Weight	14g
Dimensions	28.5mm*26mm*26mm

