



# PT-109 40 EP

## Owner's Manual



### Specifications

- Hull Length..... 40 in (1016mm)
- Beam..... 10.5 in (267mm)
- Motor..... Water-cooled 550-size (x2)
- Speed Control..... Waterproof electronic w/reverse
- Radio System..... Pro Boat 2-stick 27MHz AM
- Drive System..... Direct Drive
- Steering System..... 3-rudder

## Introduction

Thank you for purchasing the Pro Boat™ PT-109™ Ready-To-Run boat. Please read these instructions carefully before attempting to operate your boat.

The PT-109 comes Ready-To-Run with the Pro Boat 27MHz AM radio system and electronic speed controller already installed. All assembly and building is done at the factory, allowing you to quickly get your boat running.

## Table of Contents

Table of Contents .....	2
Introduction.....	2
General Guidelines .....	3
Additional Required Items .....	3
Inspection .....	3
Contents .....	4
Getting Started .....	4
Installing the Transmitter Batteries .....	5
Installing the Motor Batteries.....	6
Checking the Radio System .....	7
Accessory Installation .....	9
Testing Your Boat in the Water .....	12
Maintenance .....	12
Replacement Parts.....	13
Identification of Components .....	14
Instructions for Disposal of WEEE by Users in the European Union.....	15
Warranty Information.....	15
Operating Notes .....	19

## General Guidelines

It is important you read and follow this instruction manual before you run this exciting boat. Failure to read and understand the manual could result in personal injury, property damage or permanent damage to your boat. It is also important to run your boat responsibly. With proper care and maintenance, you will be able to proudly enjoy your PT-109 for many years to come.

When operating the boat, stay clear of people, full-scale boats, stationary objects and wildlife. It is preferable to operate the PT-109 in low-wake, low-wind conditions and in areas free of people, wildlife and objects.

Before you operate your model, make sure your frequency is clear. If someone is operating on the same frequency, both models could go out of control, possibly causing damage to the models or to others. Check all of the hardware and the propeller for damage and loose screws before and after each run.

## Additional Required Items

You will need to purchase the following to get your boat on the water:

- 8 AA alkaline batteries for the radio transmitter
- 6-cell 3300mAh Ni-MH battery pack (DYN1185) (2)
- Charger for motor batteries (DYN4033)
- Medium CA
- Soldering iron w/solder

## Inspection

Carefully remove the boat, radio transmitter, battery and charger from the box. Inspect all items to make sure no damage is present. If you notice damage is present, please contact the hobby shop where you purchased your model.

## Contents

- Assembled PT-109 RTR
- Pro Boat radio transmitter
- Boat stand



## Getting Started

Before you start running your new PT-109, it is absolutely necessary that you read through all of the operating instructions to prevent unnecessary damage and get the maximum enjoyment from your boat.

### **Charging the Motor Battery**

Plug the battery charger into a standard 110/120V AC wall outlet or 12 volts DC depending on the type of charger used.

Connect a fully discharged battery to the charge plug.

Change the battery according to the instructions provided with the charger.

Do not leave the battery pack unattended while charging or serious damage or fire may occur.

## Installing the Transmitter Batteries

Remove the transmitter battery cover by sliding the cover from top to bottom.

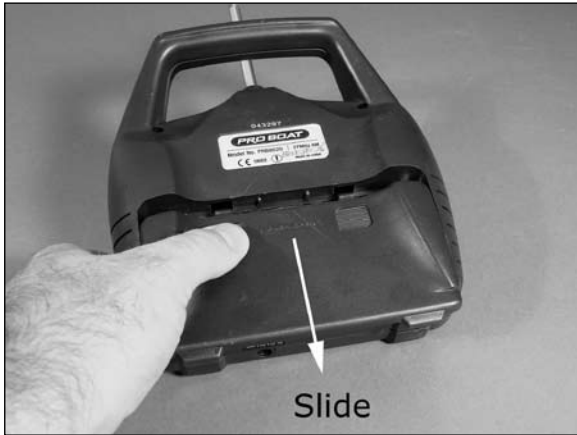

Install the battery cover by sliding it on from bottom to top.



Install eight (8) AA batteries into the transmitter. Pay close attention to the correct direction of the positive (+) and negative (-) ends as marked.



## Installing the Motor Batteries

Once the batteries are charged, apply the supplied hook and loop tape to the batteries.



Attach the remaining hook and loop to the hull as shown.



Install the battery packs into the hull as shown. Batteries are located on the left and right side of the hull.



Confirm the receiver switch has been set to the "OFF" position at this time.

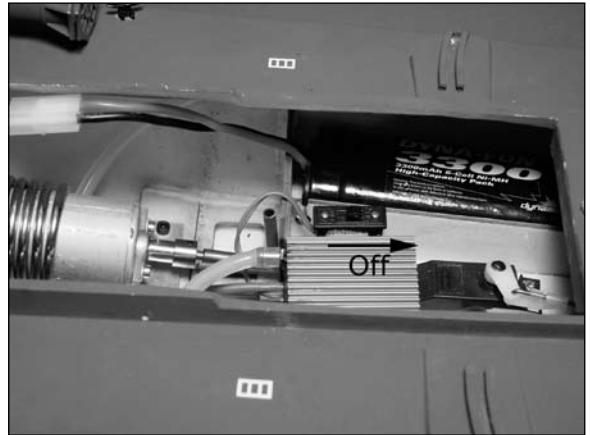

Plug the connectors from battery packs to the connectors from the ESC.



## Checking the Radio System

Check to make sure the propellers are free from any objects. The first time you turn on your PT-109 the motors may start, and any objects near the propellers, or even the propellers, may become damaged.

Always turn on the transmitter first by sliding the switch on the front of the transmitter from left to right. The small red and green lights on the front of the transmitter should both light up. If not, you need to check for low or incorrectly installed batteries.



If the propellers spin, adjust the Throttle Trim lever located next to the throttle stick until the propellers stop.

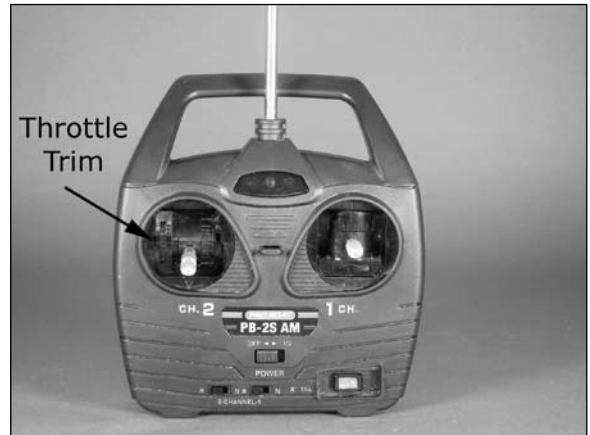

Give a small amount of throttle input by moving the throttle stick toward the top of the transmitter to ensure the motors are working.



### Checking the Throttle Operation

Once the transmitter has been turned on, turn on the PT-109 by sliding the switch on the speed controller to the "On" position.

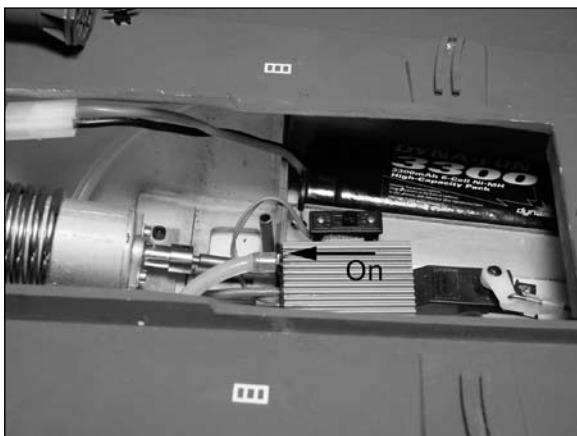

To test reverse speed operation, wait for the model to stop then move the throttle stick toward the bottom of the transmitter. Once everything is functioning correctly, you are ready to check the operation of the steering.

## Checking the Radio System

### Checking the Steering Operation

With your PT-109 and transmitter on, move the steering stick to the right to make the rudders move to the right to incur a right turn. Conversely, when left input is given, the rudders will move to the left.

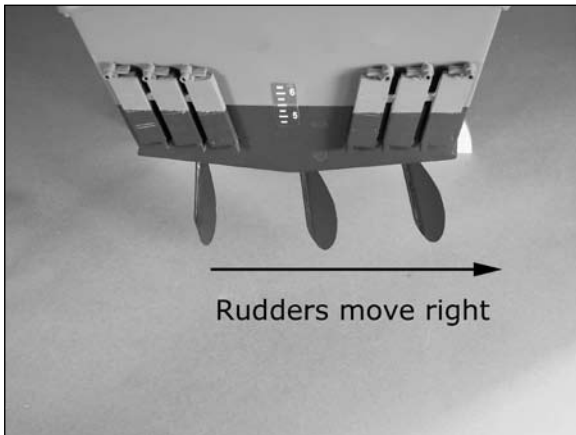

It may be necessary to adjust the Steering Trim so the rudders are centered prior to operation. Use the Steering Trim to center the rudders prior to operation. You may also need to fine-tune the steering trim to make sure the boat runs straight during operation. This can only be accomplished when operating the boat in the water and is detailed in a following section.



After you have completed checking your radio system, turn the PT-109 receiver off **FIRST** by sliding the switch to the "OFF" position. After the model has been turned off, turn off the transmitter.

If you find the steering or throttle operates backwards as described, you may need to actuate the servo reversing switch.

**Note:** If you are transporting your PT-109, make sure you disconnect the batteries from the speed controller and then turn your radio off until you are ready to run the boat. Once ready, simply plug the batteries into the speed controller, turn the radio on and make sure that the boat is in neutral.

### Range Testing

Collapse the transmitter antenna and move the rudder controls. Walk away from the boat and confirm that you have control at least 20 yards away.



## Accessory Installation

Use a #1 Phillips screwdriver to remove the screw from the rear cover.

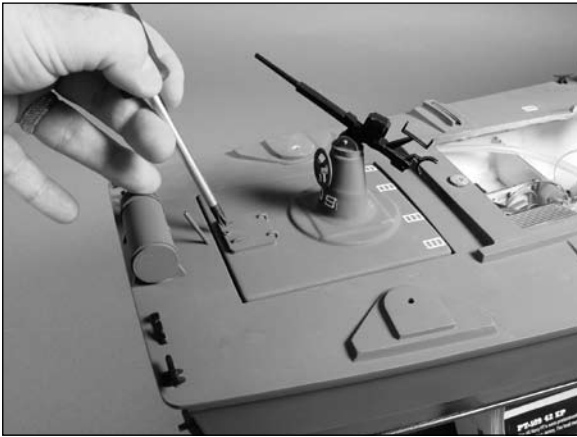

Carefully lift the rear cover at the rear. A tab holds the cover at the front, so pull the cover rearward to release the tab. Set the cover aside in a safe place.



The torpedos are attached to the hull using a tab at the front and a piece of rubber tubing at the rear. Once the torpedos are in place on the hull, you will need to slide the tubing onto the threaded studs from inside the hull.

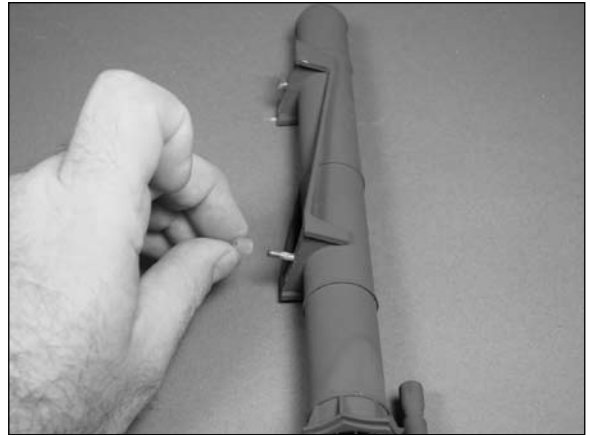

Place the tab on the front of the torpedo into the slot on the hull. Rotate the torpedo into position, making sure you keep the torpedo close to the hull to prevent damaging the tab.



## Accessory Installation

Lower the threaded stud into the pre-drilled holes in the top of the hull. Slide the tubing onto the stud from the inside of the hull. Repeat this step for all four torpedos.



Slide the rear mast into the tube at the rear of the hull.

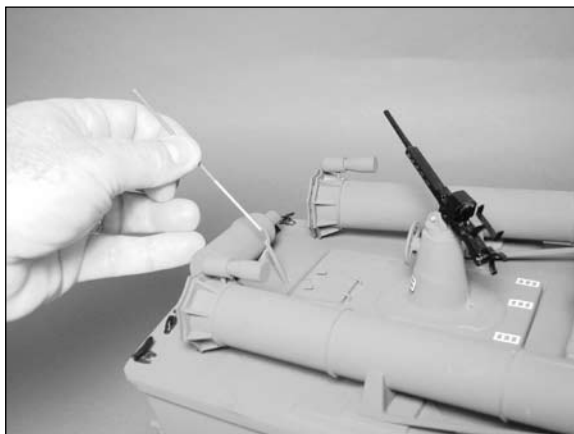

Slide the scale antenna into position on the side of the driver's cabin.



Slide the front of the torpedos so they are aligned with the hull. Once all the torpedos are in position, replace the rear cover and use a #1 Phillips screwdriver to attach the cover.



Slide the spotlight into position in the tube next to the driver's seat.

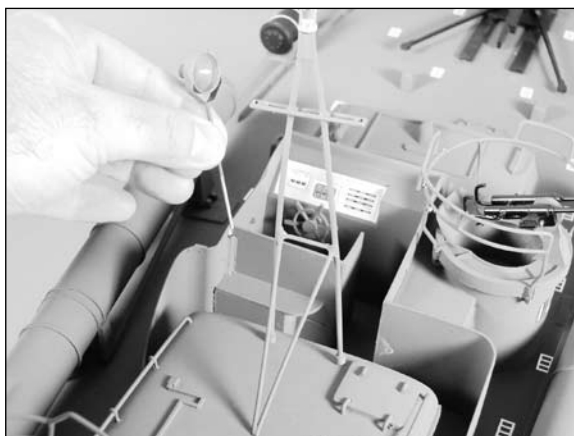

## Accessory Installation

Slide the navigation light into the forward hatch, guiding the wires through the holes in the cabin. Use medium CA to secure the navigation light to the front hatch.

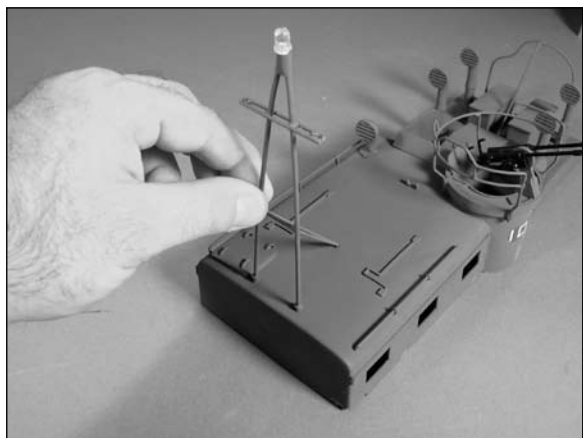

Use heat-shrink tubing or electrical tape to insulate the connection made in the previous step.

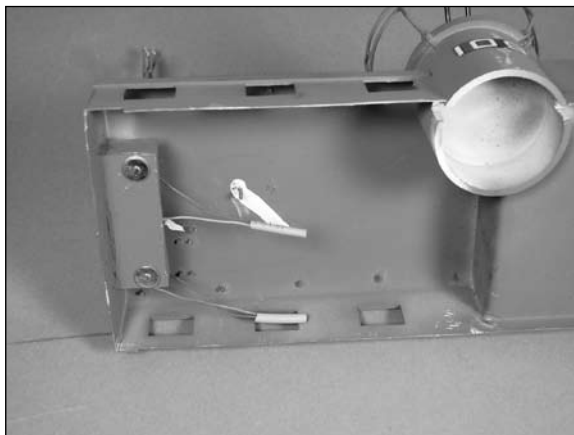

Carefully solder the wires together to power the navigation light, making sure to connect the red wire to the red wire and the black wire to black wire. The electrical connection to power the light is made at the front magnets when the hatch is mounted to the hull.

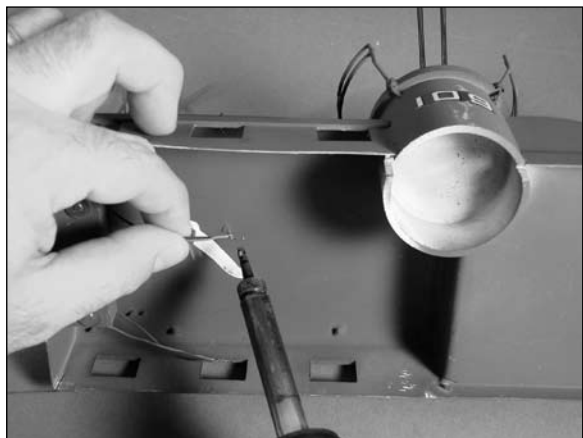

The switch to turn the accessory lighting on is located on the left side of the hull near the motor. The lighting will only power on when the batteries are connected to the speed controller. With the batteries plugged in, turn on the lighting and place the forward hatch in place. Sit back and enjoy the glow from the scale lighting of your PT-109.

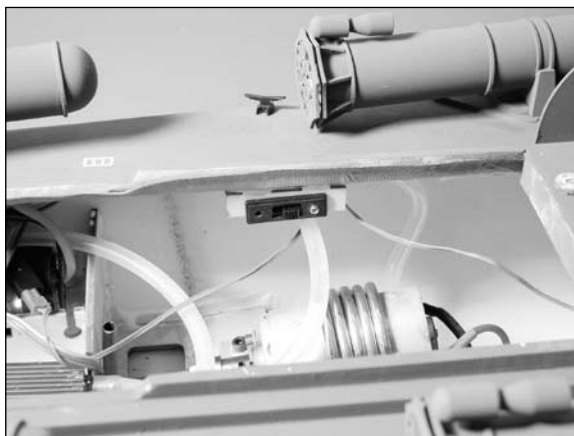

## Testing Your Boat in the Water

Make sure the radio is "ON" and the battery is plugged into the speed controller. Test the radio system for proper operation and then carefully place the boat in the water. Pilot the boat at slow speeds, staying close to the shoreline to ensure you have good control and that the boat is functioning correctly. Be certain to avoid all objects in the water at all times.

Once you feel comfortable with the control of your boat, it is safe to go further away from the shoreline and at faster speeds. When you notice the boat beginning to lose speed, bring the boat back to shore. It will be necessary to allow the electronic components to cool down and to replace or recharge the battery before heading out again.

### Adjust the Steering Trim

When going forward, the model should move in a straight line. If not, adjust the steering trim so that it tracks in a straight line without having to turn the steering wheel.

## Maintenance

Before and at the end of each run, make sure all screws are tight and the propellers are free from any entanglement. At the end of each run, be sure to remove any debris from the rudders and/or propellers and rinse the hull of your boat as well.

### Lubricating the Drive Shaft

The drive shafts should be lubricated immediately after running in salt water, after every 3–4 hours of use and at the end of each boating season prior to storage to ensure proper operation of your boat.

To lubricate the drive shafts, simply place the end of the PRB0100 Grease Gun w/Marine Grease (see your local hobby shop) into the grease tube near the motors. Apply grease until it starts to run out of the end of the drive shaft tube.



Periodically, you may have to remove the driveshafts to remove build-up. Lubricate the shaft prior to installation.

**Note:** Running the PT-109 RTR in salt water could cause some parts to corrode. If you run the boat in salt water, rinse it thoroughly in fresh water after each use and lubricate the drive system.

## Replacement Parts

If you have any questions concerning the setup or running of your PT-109, please call the Horizon Service Center toll-free at (877) 504-0233.

PRB3105	Motor
PRB3601	Hull Only
PRB3602	Main Canopy
PRB3603	Rear Hatch
PRB3604	Stuffing Box Strut
PRB3605	Driveshafts w/Hardware
PRB3606	Rudder Pushrods w/Hardware
PRB3607	Cooling System
PRB3608	Motor Mounts
PRB3609	Machine Guns
PRB3610	Torpedo (4)
PRB3611	Light Kit Complete
PRB3612	Misc. Hull Accessories
PRB3613	Front Cannon
PRB3614	Depth Charge (2)
PRB3615	Smoke Bomb
PRB3616	Light Mast
PRB3617	Search Light
PRB3618	Flag Pole
PRB3619	Antenna
PRB3620	Rudder (3)
PRB3621	Propeller (2)
PRB3622	Decal
PRB3623	ESC w/Reverse
PRB3624	Boat Stand

# Identification of Components

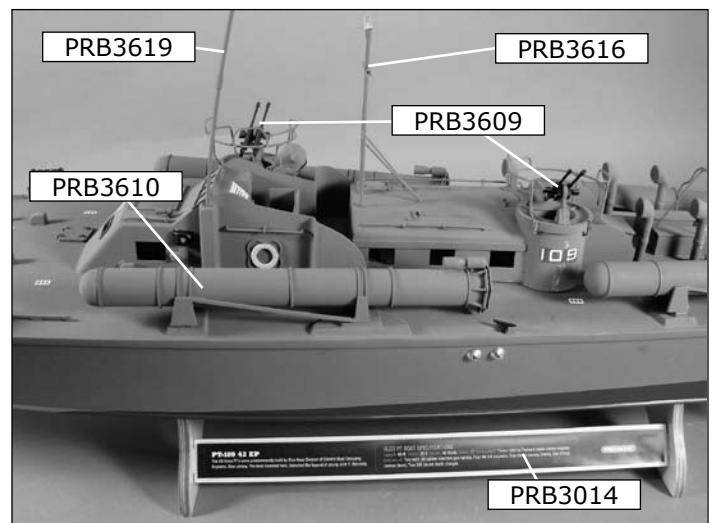
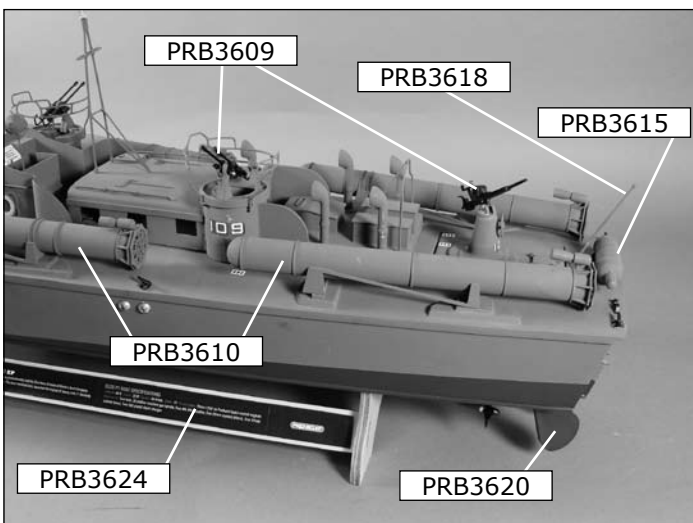
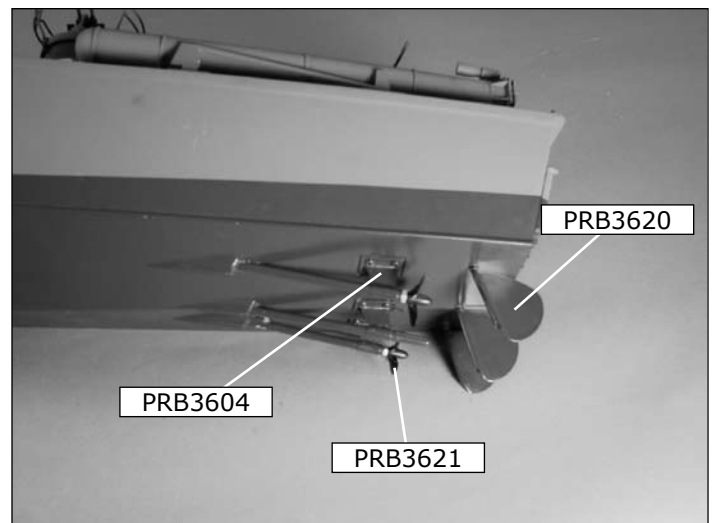
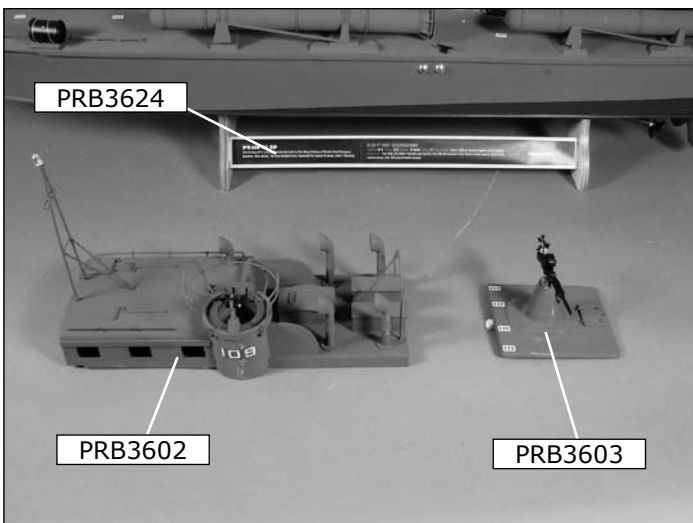
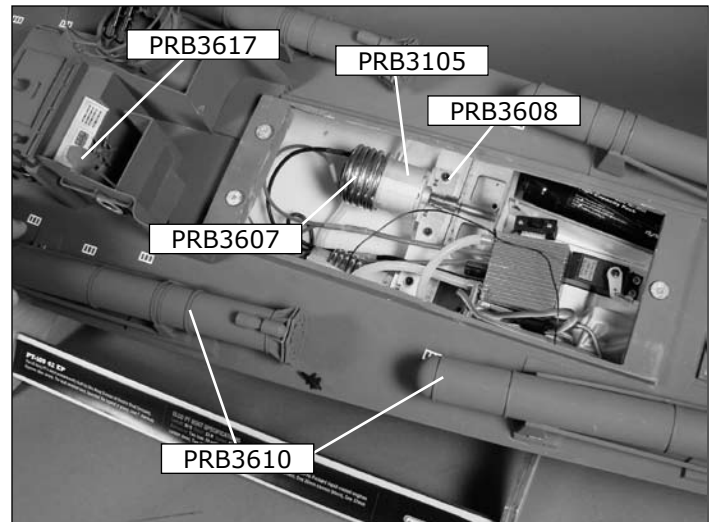
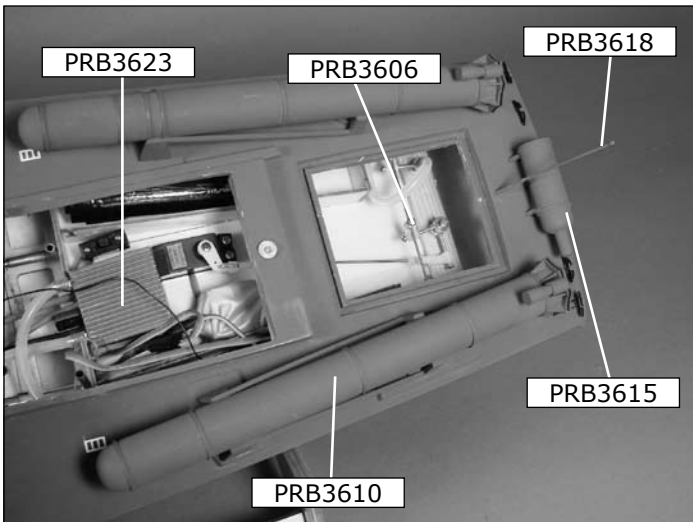

## Instructions for Disposal of WEEE by Users in the European Union

This product must not be disposed of with other waste. Instead, it is the user's responsibility to dispose of their waste equipment by handing it over to a designated collection point for the recycling of waste electrical and electronic equipment. The separate collection and recycling of your waste equipment at the time of disposal will help to conserve natural resources and ensure that it is recycled in a manner that protects human

health and the environment. For more information about where you can drop off your waste equipment for recycling, please contact your local city office, your household waste disposal service or where you purchased the product.



## Warranty Information

### Warranty Period

Horizon Hobby, Inc., (Horizon) warrants that the Products purchased (the "Product") will be free from defects in materials and workmanship at the date of purchase by the Purchaser.

### Limited Warranty

(a) This warranty is limited to the original Purchaser ("Purchaser") and is not transferable. REPAIR OR REPLACEMENT AS PROVIDED UNDER THIS WARRANTY IS THE EXCLUSIVE REMEDY OF THE PURCHASER. This warranty covers only those Products purchased from an authorized Horizon dealer. Third party transactions are not covered by this warranty. Proof of purchase is required for warranty claims. Further, Horizon reserves the right to change or modify this warranty without notice and disclaims all other warranties, express or implied.

(b) Limitations- HORIZON MAKES NO WARRANTY OR REPRESENTATION, EXPRESS OR IMPLIED, ABOUT NON-INFRINGEMENT, MERCHANTABILITY OR

FITNESS FOR A PARTICULAR PURPOSE OF THE PRODUCT. THE PURCHASER ACKNOWLEDGES THAT THEY ALONE HAVE DETERMINED THAT THE PRODUCT WILL SUITABLY MEET THE REQUIREMENTS OF THE PURCHASER'S INTENDED USE.

(c) Purchaser Remedy- Horizon's sole obligation hereunder shall be that Horizon will, at its option, (i) repair or (ii) replace, any Product determined by Horizon to be defective. In the event of a defect, these are the Purchaser's exclusive remedies. Horizon reserves the right to inspect any and all equipment involved in a warranty claim. Repair or replacement decisions are at the sole discretion of Horizon. This warranty does not cover cosmetic damage or damage due to acts of God, accident, misuse, abuse, negligence, commercial use, or modification of or to any part of the Product. This warranty does not cover damage due to improper installation, operation, maintenance, or attempted repair by anyone other than Horizon. Return of any goods by Purchaser must be approved in writing by Horizon before shipment.

## Warranty Information

### Damage Limits

HORIZON SHALL NOT BE LIABLE FOR SPECIAL, INDIRECT OR CONSEQUENTIAL DAMAGES, LOSS OF PROFITS OR PRODUCTION OR COMMERCIAL LOSS IN ANY WAY CONNECTED WITH THE PRODUCT, WHETHER SUCH CLAIM IS BASED IN CONTRACT, WARRANTY, NEGLIGENCE, OR STRICT LIABILITY. Further, in no event shall the liability of Horizon exceed the individual price of the Product on which liability is asserted. As Horizon has no control over use, setup, final assembly, modification or misuse, no liability shall be assumed nor accepted for any resulting damage or injury. By the act of use, setup or assembly, the user accepts all resulting liability.

If you as the Purchaser or user are not prepared to accept the liability associated with the use of this Product, you are advised to return this Product immediately in new and unused condition to the place of purchase.

Law: These Terms are governed by Illinois law (without regard to conflict of law principals).

### Safety Precautions

This is a sophisticated hobby Product and not a toy. It must be operated with caution and common sense and requires some basic mechanical ability. Failure to operate this Product in a safe and responsible manner could result in injury or damage to the Product or other property. This Product is not intended for use by children without direct adult supervision.

The Product manual contains instructions for safety, operation and maintenance. It is essential to read and follow all the instructions and warnings in the manual, prior to assembly, setup or use, in order to operate correctly and avoid damage or injury.

### Questions, Assistance, and Repairs

Your local hobby store and/or place of purchase cannot provide warranty support or repair. Once assembly, setup or use of the Product has been started, you must contact Horizon directly. This will enable Horizon to better answer your questions and service you in the event that you may need any assistance.

For questions or assistance, please direct your email to [productsupport@horizonhobby.com](mailto:productsupport@horizonhobby.com), or call 877.504.0233 toll-free to speak to a service technician.



## Warranty Information

### Inspection or Repairs

If this Product needs to be inspected or repaired, please call for a Return Merchandise Authorization (RMA). Pack the Product securely using a shipping carton. Please note that original boxes may be included, but are not designed to withstand the rigors of shipping without additional protection. Ship via a carrier that provides tracking and insurance for lost or damaged parcels, as Horizon is not responsible for merchandise until it arrives and is accepted at our facility. A Service Repair Request is available at [www.horizonhobby.com](http://www.horizonhobby.com) on the "Support" tab.

If you do not have internet access, please include a letter with your complete name, street address, email address and phone number where you can be reached during business days, your RMA number, a list of the included items, method of payment for any non-warranty expenses and a brief summary of the problem. Your original sales receipt must also be included for warranty consideration. Be sure your name, address, and RMA number are clearly written on the outside of the shipping carton.

### Warranty Inspection and Repairs

To receive warranty service, you must include your original sales receipt verifying the proof-of-purchase date. Provided warranty conditions have been met, your Product will be repaired or replaced free of charge.

Repair or replacement decisions are at the sole discretion of Horizon Hobby.

### Non-Warranty Repairs

Should your repair not be covered by warranty the repair will be completed and payment will be required without notification or estimate of the expense unless the expense exceeds 50% of the retail purchase cost. By submitting the item for repair you are agreeing to payment of the repair without notification. Repair estimates are available upon request. You must include this request with your repair. Non-warranty repair estimates will be billed a minimum of ½ hour of labor. In addition you will be billed for return freight. Please advise us of your preferred method of payment. Horizon accepts money orders and cashiers checks, as well as Visa, MasterCard, American Express, and Discover cards. If you choose to pay by credit card, please include your credit card number and expiration date. Any repair left unpaid or unclaimed after 90 days will be considered abandoned and will be disposed of accordingly. Please note: non-warranty repair is only available on electronics and model engines.

Electronics and engines requiring inspection or repair should be shipped to the following address:

Horizon Service Center  
4105 Fieldstone Road  
Champaign, Illinois 61822

All other Products requiring warranty inspection or repair should be shipped to the following address:

Horizon Product Support  
4105 Fieldstone Road  
Champaign, Illinois 61822

Please call 877-504-0233 with any questions or concerns regarding this product or warranty.

# Warranty Information

## **Safety, Precautions, and Warnings**

As the user of this product, you are solely responsible for operating it in a manner that does not endanger yourself and others or result in damage to the product or the property of others.

Carefully follow the directions and warnings for this and any optional support equipment (chargers, rechargeable battery packs, etc.) that you use.

This model is controlled by a radio signal that is subject to interference from many sources outside your control. This interference can cause momentary loss of control so it is necessary to always keep a safe distance in all directions around your model, as this margin will help to avoid collisions or injury.

- Always operate your model in an open area away from people.
- Avoid operating your model where injury or damage can occur.
- Never operate the model out in populated areas for any reason.
- Never operate your model with low transmitter batteries.
- Carefully follow the directions and warnings for this and any optional support equipment (chargers, rechargeable battery packs, etc.) that you use.
- Keep all chemicals, small parts and anything electrical out of the reach of children.
- Moisture causes damage to electronics. Avoid prolonged water exposure to all equipment not specifically designed and protected for this purpose.





[www.ProBoatModels.com](http://www.ProBoatModels.com)



© 2007, Horizon Hobby, Inc.  
4105 Fieldstone Road  
Champaign, Illinois 61822  
(877) 504-0233  
[www.horizonhobby.com](http://www.horizonhobby.com)