



Fly First Class™

Alpha 40 with Spektrum™ DX5e

ASSEMBLY MANUAL



Specifications

Wingspan.....	63 in (1600mm)	Engine Size.....	.45 cu in (included)
Length w/Spinner.....	52.5 in (1334mm)	Radio.....	Spektrum DX5e (included)
Wing Area.....	710 sq in (45.8 sq dm)	Servos.....	4 servos (included)
Flying Weight.....	5.25 lb (2.4 kg)		

Table of Contents

Using the Manual	3
Required Items	3
Optional Parts and Accessories	3
Required Tools and Adhesives	3
UltraCote Covering Colors	4
Before Starting Assembly	4
FS One	4
Instructions for Disposal of WEEE by Users in the European Union	4
Warranty Information	5
Safety, Precautions, and Warnings	7
Contents of Kit	7
Section 1: Landing Gear Installation	8
Section 2: Fin and Stabilizer Installation	10
Section 3: Propeller and Spinner Installation	13
Section 4: Wing Dowel Installation	15
Section 5: Wing Assembly	16
Section 5b: Optional: Gluing the Wing Halves	17
Section 6: Centering the Control Surfaces	20
Section 7: Wing Installation	21
Section 8: Your Spektrum DX5e Radio System	22
Section 9: Battery Installation	22
Section 10: Digital Trims	23
Section 11: Low Battery Alarm	23
Section 12: Trainer	23
Section 13: Binding	24
Section 14: Checking the Control Surface Movement	27
Section 15: Hi/Lo Rate	31
Section 16: Setting the Control Throws	32
Section 17: Checking the Throttle Operation	33
Section 18: Balancing Your Alpha RTF	35
Section 19: Flight Preparations	36
Section 20: How to Range Test the DX5e	37
Section 21: Starting and Adjusting the Evolution Engine	38
Section 22: Maintaining Your Alpha 40 RTF	41
Safety Do's and Don'ts for Pilots	43
Daily Flight Checks	43
Glossary of Terms	44
Building and Flying Notes	45
2008 Official AMA National Model Aircraft Safety Code	46

Using the Manual

This manual is divided into sections to help make assembly easier to understand, and to provide breaks between each major section. In addition, check boxes have been placed next to each step to keep track of each step completed. Steps with a single box () are performed once, while steps with two boxes () indicate that the step will require repeating, such as for a right or left wing panel, two servos, etc. Remember to take your time and follow the directions.

Required Items

- Fuel (10%–15% nitro content)
- Glow Plug Igniter with Charger (HAN7101)
- Manual Fuel Pump (HAN118)
- or
- Start-Up Field Pack (HANSTART)
- Glow Plug Wrench (HAN2510)
- Glow Plug (EVOGP1)

Optional Parts and Accessories

- Fieldmate Prebuilt Field Box (HAN117)
- Metered Glow Driver w/Ni-Cd and Charger (HAN7101)
- Manual Fuel Pump (HAN118)
- Aluminum Transmitter Case for Single Tx (HAN124)
- Long Reach Glow Plug Wrench (HAN2510)
- Transmitter Stand (HAN2525)
- Hangar 9 Straw Hat (HANP303)
- Sealing Iron Sock (HAN141)
- Covering Glove (HAN150)
- Mosfet Power Panel (HAN106)
- PowerPro 12V Starter (HAN161)
- Double Vision Fast Field Charger (HAN114)
- Digital Variable Load Voltmeter (HAN171)
- Super Glow Plug (EVOGP1)
- Angle Pro Throw/Incidence Meter (HAN192)
- Sealing Iron (HAN101)
- Heat Gun (HAN100)
- Trainer Power System Propeller (EVOE100P)

Required Tools and Adhesives

- #64 Rubber Bands (ARC064)
- Felt-tipped pen
- 30-minute Epoxy (HAN8002)
- Phillips screwdriver: #2
- Rubbing alcohol
- Ruler
- Thin CA (MEUM5T10Z)
- 4-Way Wrench (DUB810)
- Adjustable wrench
- Hobby knife
- Paper towels
- Masking tape
- Hobby scissors
- Epoxy brush

UltraCote Covering Colors

- White (HANU870)
- Orange (HANU877)
- Black (HANU874)
- Silver (HANU881)

Before Starting Assembly

Before beginning the assembly of the Alpha RTF w/DSM, remove each part from its bag for inspection. Closely inspect the fuselage, wing panels, rudder, and stabilizer for damage. If you find any damaged or missing parts, contact the place of purchase.

If you find any wrinkles in the covering, use a heat gun or sealing iron to remove them. Use caution while working around areas where the colors overlap to prevent separating the colors.



HAN101 – Sealing Iron

**HAN141 – Sealing Iron
Sock**



HAN100 – Heat Gun

HAN150 – Covering Glove

FS One

With FS One you get more than photorealistic fields, gorgeous skies and realistic-looking aircraft. You get incredibly advanced aerodynamic modeling that simulates every possible aspect of real-world flight.

The first Hangar Pack will add even more aircraft to FS One. This latest edition includes ten new planes and helis from your favorite brands, including Hangar 9, E-flite and Align. You'll be able to fly aircraft that are only available on FS One such as the T-REX, Blade CX2, Blade CP Pro, Hangar 9 P-51 and F-22 PTS. And as always, with the Hangar Pack, you still get all the same great features that you did with the original aircraft.



HANS2000



HANS4010

Instructions for Disposal of WEEE by Users in the European Union

This product must not be disposed of with other waste. Instead, it is the user's responsibility to dispose of their waste equipment by handing it over to a designated collection point for the recycling of waste electrical and electronic equipment. The separate collection and recycling of your waste equipment at the time of disposal will help to conserve natural resources and ensure that it is recycled in a manner that protects human health and the environment. For more information about where you can drop off your waste equipment for recycling, please contact your local city office, your household waste disposal service or where you purchased the product.



Warranty Information

Warranty Period

Exclusive Warranty- Horizon Hobby, Inc., (Horizon) warrants that the Products purchased (the "Product") will be free from defects in materials and workmanship at the date of purchase by the Purchaser.

Limited Warranty

(a) This warranty is limited to the original Purchaser ("Purchaser") and is not transferable. REPAIR OR REPLACEMENT AS PROVIDED UNDER THIS WARRANTY IS THE EXCLUSIVE REMEDY OF THE PURCHASER. This warranty covers only those Products purchased from an authorized Horizon dealer. Third party transactions are not covered by this warranty. Proof of purchase is required for warranty claims. Further, Horizon reserves the right to change or modify this warranty without notice and disclaims all other warranties, express or implied.

(b) Limitations- HORIZON MAKES NO WARRANTY OR REPRESENTATION, EXPRESS OR IMPLIED, ABOUT NON-INFRINGEMENT, MERCHANTABILITY OR FITNESS FOR A PARTICULAR PURPOSE OF THE PRODUCT. THE PURCHASER ACKNOWLEDGES THAT THEY ALONE HAVE DETERMINED THAT THE PRODUCT WILL SUITABLY MEET THE REQUIREMENTS OF THE PURCHASER'S INTENDED USE.

(c) Purchaser Remedy- Horizon's sole obligation hereunder shall be that Horizon will, at its option, (i) repair or (ii) replace, any Product determined by Horizon to be defective. In the event of a defect, these are the Purchaser's exclusive remedies. Horizon reserves the right to inspect any and all equipment involved in a warranty claim. Repair or replacement decisions are at the sole discretion of Horizon. This warranty does not cover cosmetic damage or damage due to acts of God, accident, misuse, abuse, negligence, commercial use, or modification of or to any part of the Product. This warranty does not cover damage due to improper installation, operation, maintenance, or attempted repair by anyone other than Horizon. Return of any goods by Purchaser must be approved in writing by Horizon before shipment.

Damage Limits

HORIZON SHALL NOT BE LIABLE FOR SPECIAL, INDIRECT OR CONSEQUENTIAL DAMAGES, LOSS OF PROFITS OR PRODUCTION OR COMMERCIAL LOSS IN ANY WAY CONNECTED WITH THE PRODUCT, WHETHER SUCH CLAIM IS BASED IN CONTRACT, WARRANTY, NEGLIGENCE, OR STRICT LIABILITY. Further, in no event shall the liability of Horizon exceed the individual price of the Product on which liability is asserted. As Horizon has no control over use, setup, final assembly, modification or misuse, no liability shall be assumed nor accepted for any resulting damage or injury. By the act of use, setup or assembly, the user accepts all resulting liability.

If you as the Purchaser or user are not prepared to accept the liability associated with the use of this Product, you are advised to return this Product immediately in new and unused condition to the place of purchase.

Law: These Terms are governed by Illinois law (without regard to conflict of law principals).

Safety Precautions

This is a sophisticated hobby Product and not a toy. It must be operated with caution and common sense and requires some basic mechanical ability. Failure to operate this Product in a safe and responsible manner could result in injury or damage to the Product or other property. This Product is not intended for use by children without direct adult supervision. The Product manual contains instructions for safety, operation and maintenance. It is essential to read and follow all the instructions and warnings in the manual, prior to assembly, setup or use, in order to operate correctly and avoid damage or injury.

Questions, Assistance, and Repairs

Your local hobby store and/or place of purchase cannot provide warranty support or repair. Once assembly, setup or use of the Product has been started, you must contact Horizon directly. This will enable Horizon to better answer your questions and service you in the event that you may need any assistance. For questions or assistance, please direct your email to productsupport@horizonhobby.com, or call 877.504.0233 toll free to speak to a service technician.

Inspection or Repairs

If this Product needs to be inspected or repaired, please call for a Return Merchandise Authorization (RMA). Pack the Product securely using a shipping carton. Please note that original boxes may be included, but are not designed to withstand the rigors of shipping without additional protection. Ship via a carrier that provides tracking and insurance for lost or damaged parcels, as **Horizon is not responsible for merchandise until it arrives and is accepted at our facility**. A Service Repair Request is available at www.horizonhobby.com on the "Support" tab. If you do not have internet access, please include a letter with your complete name, street address, email address and phone number where you can be reached during business days, your RMA number, a list of the included items, method of payment for any non-warranty expenses and a brief summary of the problem. Your original sales receipt must also be included for warranty consideration. Be sure your name, address, and RMA number are clearly written on the outside of the shipping carton.

Warranty Inspection and Repairs

To receive warranty service, you must include your original sales receipt verifying the proof-of-purchase date. Provided warranty conditions have been met, your Product will be repaired or replaced free of charge. Repair or replacement decisions are at the sole discretion of Horizon Hobby.

Non-Warranty Repairs

Should your repair not be covered by warranty the repair will be completed and payment will be required without notification or estimate of the expense unless the expense exceeds 50% of the retail purchase cost. By submitting the item for repair you are agreeing to payment of the repair without notification. Repair estimates are available upon request. You must include this request with your repair. Non-warranty repair estimates will be billed a minimum of ½ hour of labor. In addition you will be billed for return freight. Please advise us of your preferred method of payment. Horizon accepts money orders and cashiers checks, as well as Visa, MasterCard, American Express, and Discover cards. If you choose to pay by credit card, please include your credit card number and expiration date. Any repair left unpaid or unclaimed after 90 days will be considered abandoned and will be disposed of accordingly. **Please note: non-warranty repair is only available on electronics and model engines.**

Electronics and engines requiring inspection or repair should be shipped to the following address:

Horizon Support Team
4105 Fieldstone Road
Champaign, Illinois 61822

All other Products requiring warranty inspection or repair should be shipped to the following address:

Horizon Product Support
4105 Fieldstone Road
Champaign, Illinois 61822

Please call 877-504-0233 with any questions or concerns regarding this product or warranty.

Safety, Precautions, and Warnings

This model is controlled by a radio signal that is subject to interference from many sources outside your control. This interference can cause momentary loss of control so it is advisable to always keep a safe distance in all directions around your model, as this margin will help to avoid collisions or injury.

- Always operate your model in an open area away from cars, traffic, or people.
- Avoid operating your model in the street where injury or damage can occur.
- Never operate the model into the street or populated areas for any reason.
- Never operate your model with low transmitter batteries.
- Carefully follow the directions and warnings for this and any optional support equipment (chargers, rechargeable battery packs, etc.) that you use.
- Keep all chemicals, small parts and anything electrical out of the reach of children.
- Moisture causes damage to electronics. Avoid water exposure to all equipment not specifically designed and protected for this purpose.

Contents of Kit

A. HAN4401	Wing Set w/Wing Tube	F. HAN2454	Landing Gear Set
B. HAN4402	Fuselage		(does not include wheels)
C. HAN4403	Tail Set	HAN304	2.5-inch Wheels (2)
D. HAN4404	Aluminum Wing Tube	HAN305	2.75-inch Wheels (2)
E. HAN4405	Decal Sheet	G. EVOE200S	Evolution Power System Orange Spinner
		H. EVOE100P	Evolution Power System Propeller

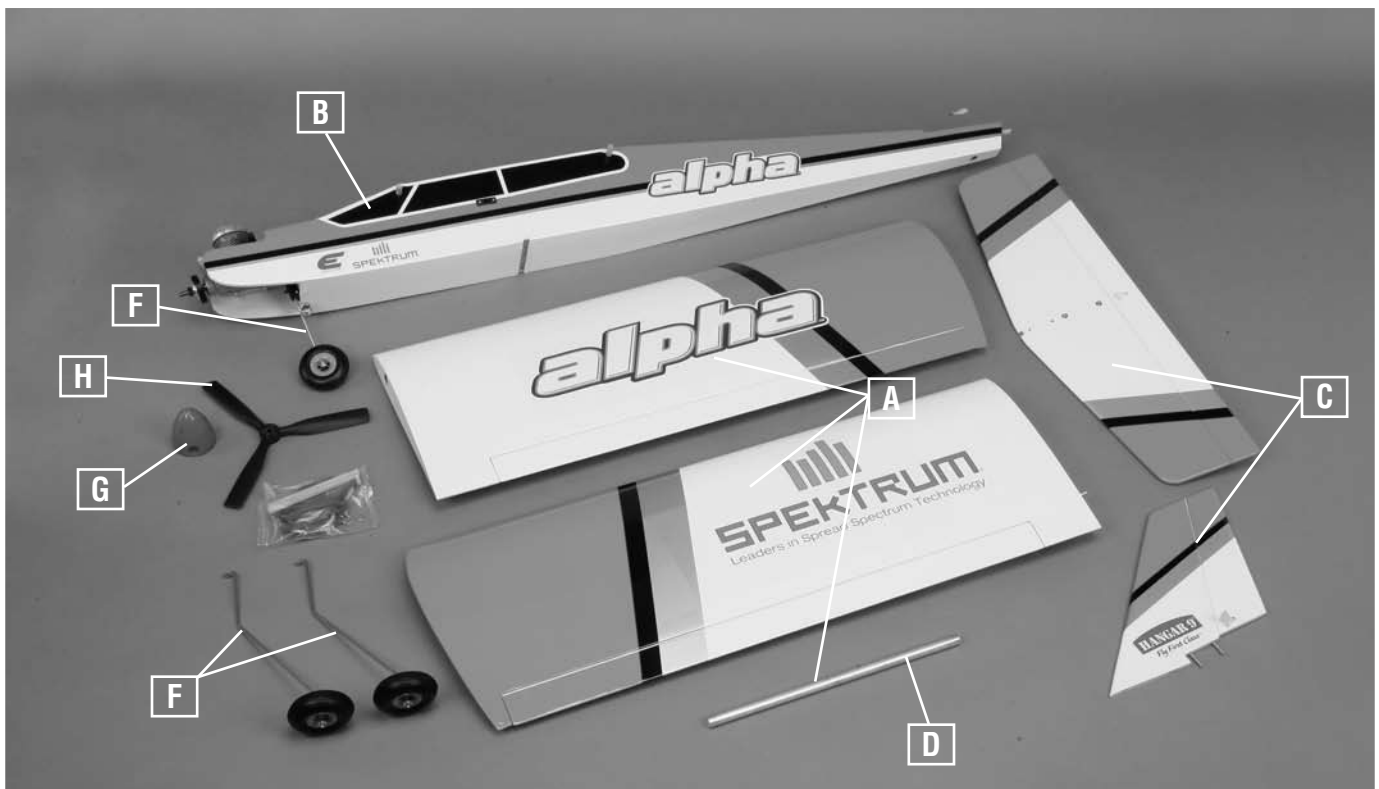

Section 1: Landing Gear Installation

Required Parts

- Fuselage
- Landing gear strap (2)
- Main landing gear assembly (2)
- 3mm x 12mm sheet metal screw (4)

Required Tools and Adhesives

- Phillips screwdriver: #2

Step 1

Locate one of the landing gear assemblies. Insert the end of the wire into the hole in the fuselage.

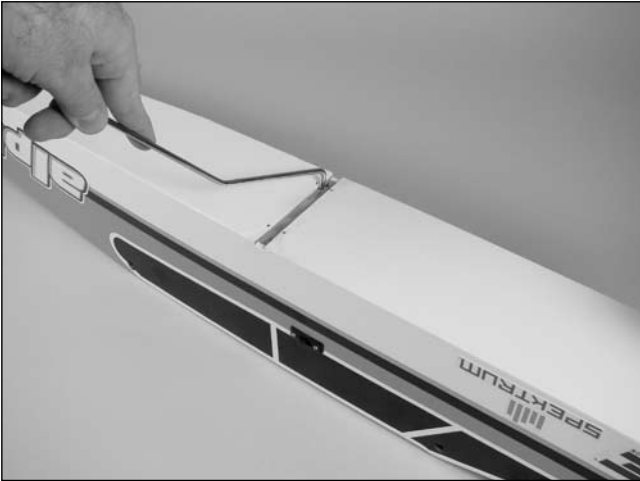

Step 2

Press the landing gear into the notch on the bottom of the fuselage so it is flush with the bottom of the fuselage.



Step 3

Repeat Steps 1 and 2 to install the remaining landing gear assembly.



Step 4

Locate one of the landing gear straps. The strap will be used to secure the main gear to the fuselage. Holes have been pre-drilled for the screws that secure the landing gear strap in position.



Note: Before installing the screws, apply 2–3 drops of thin CA into each of the holes to harden the surrounding wood. This will allow the screws to be more secure and will help in preventing them from vibrating loose.

Section 1: Landing Gear Installation

Step 5

Use a #2 Phillips screwdriver and two 3mm x 12mm sheet metal screws to secure one of the straps to the bottom of the fuselage.



Step 6

Repeat Steps 4 and 5 to secure the remaining landing gear strap to the bottom of the fuselage.

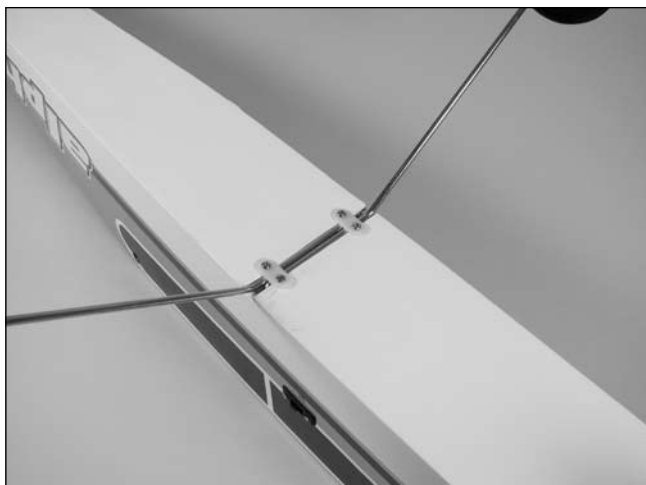

Section 2: Fin and Stabilizer Installation

Required Parts

- Fin/Rudder assembly
- #4 washer (4)
- Stabilizer/Elevator assembly
- Wing nut (2)
- 3mm x 10mm machine screw (2)

Required Tools and Adhesives

- Threadlock
- Scissors
- Phillips screwdriver: #2

Step 1

Locate the fin and stabilizer assemblies. The threaded rods from the fin will fit into the holes that are pre-drilled in the stabilizer as shown.



Step 2

Slide the two #4 washers onto the threaded rods from the bottom of the stabilizer.



Step 3

Use scissors to cut the end of the tube of threadlock. Cut only the corner so the application of the threadlock can be controlled easier than if the whole end were cut off.



Step 4

Apply a drop of threadlock onto each of the threaded rods.

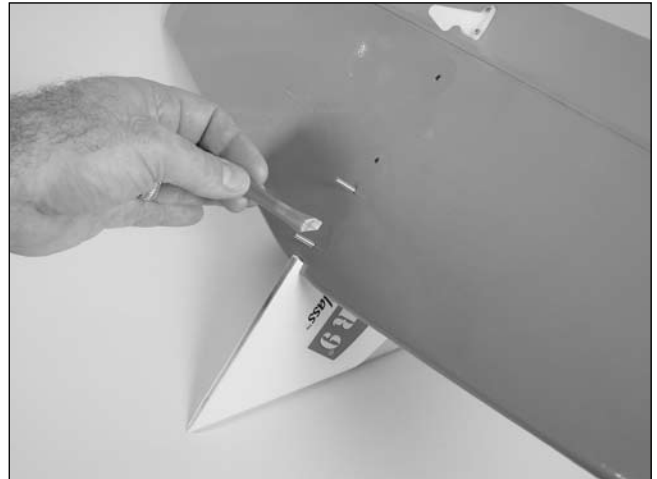

Section 2: Fin and Stabilizer Installation

□ Step 5

Thread the two wing nuts onto the threaded rods to secure the fin to the stabilizer. Don't over-tighten the wing nut and damage the underlying wood.

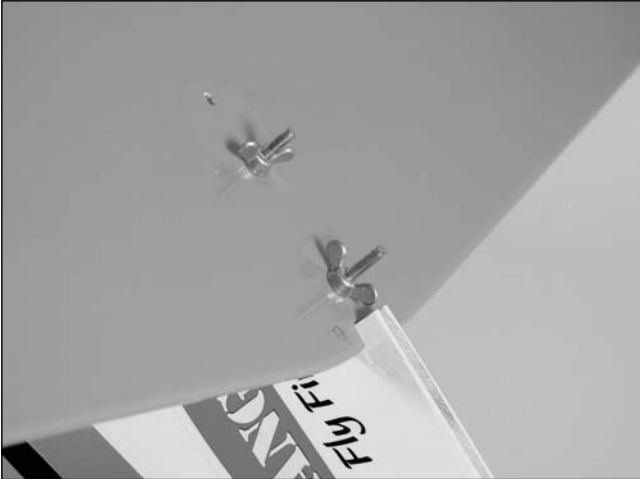

□ Step 6

Slide the fin into position. Make sure the control rod for the rudder is on the top side of the stabilizer when installing the tail assembly.



□□ Step 7

Locate a #4 washer and 3mm x 10mm machine screw. Slide the washer onto the screw, then apply a small amount of threadlock on the screw.



□□ Step 8

Insert the screw into the hole in the fuselage and through the stabilizer to the pre-installed blind nut on the top of the stabilizer. Use a #2 Phillips screwdriver to tighten the screw.



Section 2: Fin and Stabilizer Installation

□ Step 9

Repeat Steps 7 and 8 to install the second screw.



□ Step 10

Connect the clevis to the center hole of the elevator control horn. The alignment of the elevator will be covered later in this manual.



□ Step 11

Connect the clevis to the center hole of the rudder control horn. The alignment of the rudder will be covered later in this manual.

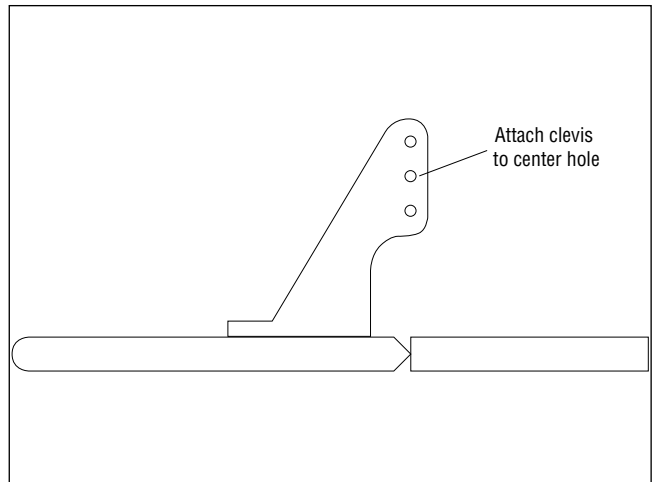

Section 3: Propeller and Spinner Installation

Required Parts

- Fuselage assembly
- Spinner assembly
- Propeller

Required Tools and Adhesives

- Adjustable wrench
- Hex wrench: 2.5mm

□ Step 1

Remove the plastic shipping saver, nut and washer from the engine crankshaft.

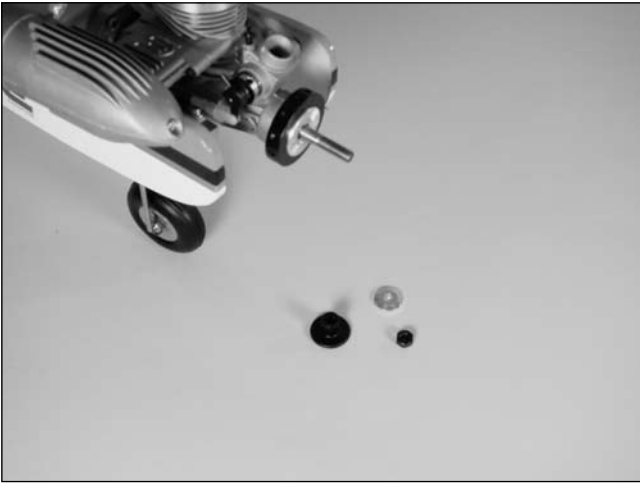

□ Step 2

Check that the flywheel is fully installed on the engine. It will fit closely to the engine when it is positioned correctly. Slide the spinner backplate onto the engine crankshaft so it is tight against the flywheel.



□ Step 3

Slide the propeller onto the engine crankshaft. The blades of the propeller will be positioned against the bosses for the spinner screws of the spinner backplate as shown below.



□ Step 4

Slide the propeller washer onto the engine crankshaft.



Section 3: Propeller and Spinner Installation

□ Step 5

Thread the propeller nut onto the engine crankshaft.



□ Step 6

Use an adjustable wrench to tighten the propeller nut, securing the propeller and spinner backplate onto the engine crankshaft.



Important: When tightening the propeller nut, always use an adjustable wrench, box end wrench or 3/8-inch drive socket. Using pliers will not allow you to place enough grip to properly tighten the propeller nut.

Note: Make sure the propeller has not moved from its position as described back in Step 3. If it has, the spinner cone will not be able to be installed in the following steps.

□ Step 7

Slide the spinner cone over the propeller. It will fit into the grooves in the spinner backplate when installed.



□□ Step 8

Use the three 3mm x 10mm sheet metal screws supplied with the spinner to secure the spinner cone to the spinner backplate. A #1 Phillips screwdriver will be required to tighten the screws.



Section 4: Wing Dowel Installation

Required Parts

- Fuselage assembly
- Wing dowel (2)

Required Tools and Adhesives

- Thin CA

Step 1

Slide the wing dowel into the pre-drilled holes in the front of the fuselage. Center the dowel so it extends equally from both sides of the fuselage.

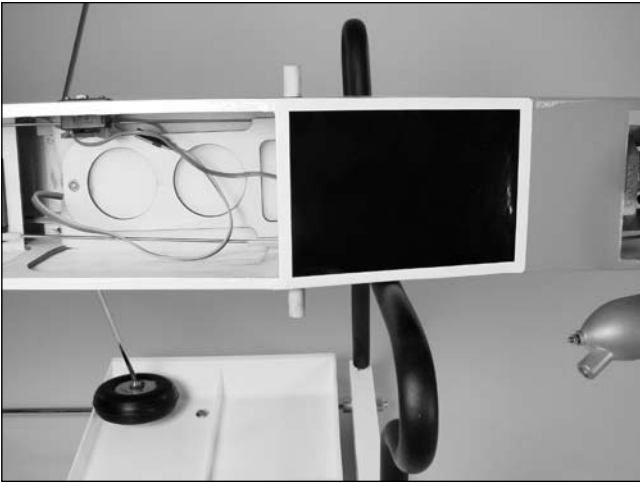

Step 2

Slide the second wing dowel into the pre-drilled holes in the rear of the fuselage. Center the dowel so it extends equally from both sides of the fuselage.

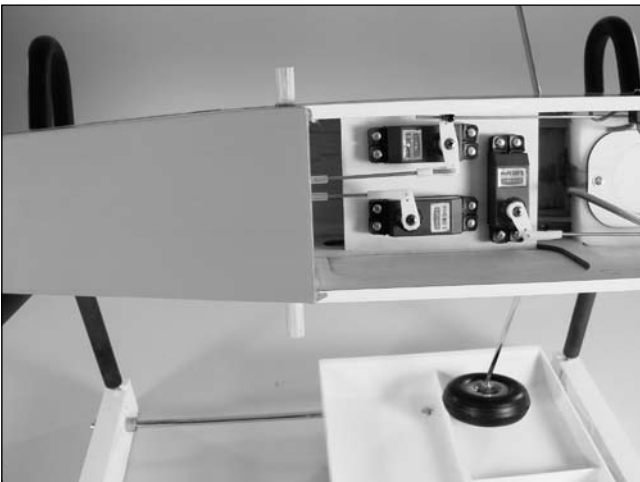

Step 3

Use the following photo to confirm the location of the wing dowel installation in the fuselage.



Step 4

Apply thin CA into the joint between the dowel and fuselage to keep it from moving.



Section 5: Wing Assembly

Required Parts

- Wing panel (left and right)
- Wing tube
- Clear tape

Note: The following covers the assembly of the wing without the use of glue. The wing, when joined in this method, is very strong and does not need to be glued together. You will want to purchase additional clear tape if you plan on breaking the wing down into two pieces for transportation purposes.

□ Step 1

Slide the wing tube into the wing panel as shown. The wing tube will only slide in halfway, so do not force it in any further than it will slide easily.

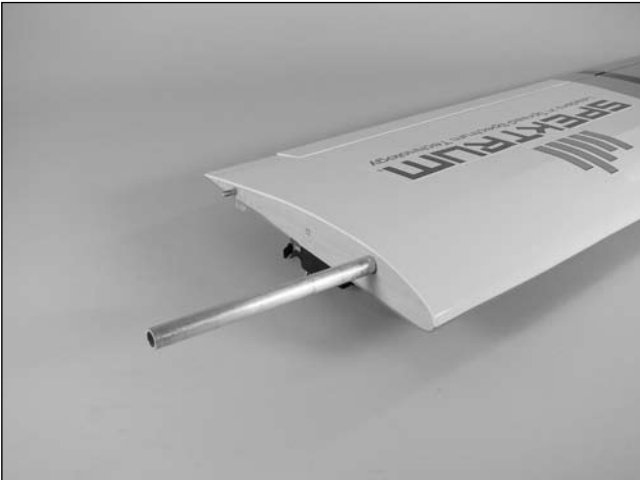

□ Step 2

Slide the remaining wing panel onto the wing tube.



□ Step 3

As you slide the wing panels together, make sure the aluminum pin at the back (trailing edge) of the wing slides into the hole of the receiving wing panel. Slide the two wing panels tightly together so there is no gap between the two.



□ Step 4

Use the supplied clear tape to secure the joint between the two wing panels. Make sure to apply the tape to both the top and bottom of the joint.



□ Step 5

Connect the clevises from the aileron pushrods to the aileron control horns. The alignment of the ailerons will be checked later in this manual.

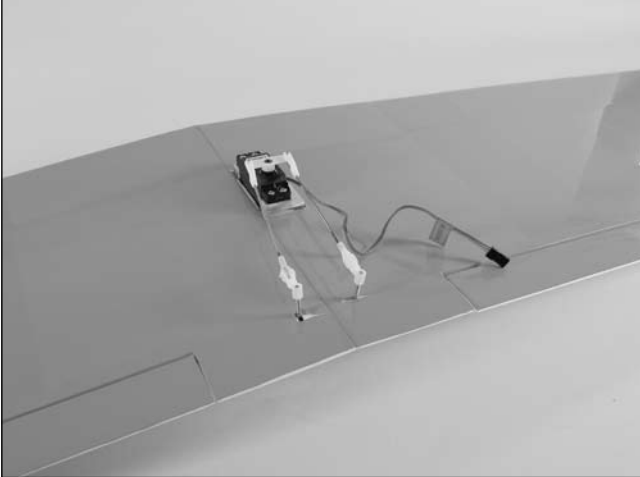

Section 5b: Optional: Gluing the Wing Halves

Required Parts

- Wing panel (left and right)
- Wing tube
- Covering (white)
- Covering (orange)

Required Tools and Adhesives

- 30-minute epoxy
- Mixing cup
- Mixing stick
- Epoxy brush
- Rubbing alcohol
- Paper towel
- Painter's tape
- Covering iron

Note: It is not necessary to glue the wing panels together on your model. This section has been provided in case you opt to do so. Make sure your vehicle has enough room to transport the joined wing before joining the wing panels using this method.

□ Step 1

Slide the wing tube into the wing panel as shown. The wing tube will only slide in halfway, so do not force it in any further than it will slide easily.



Section 5b: Optional: Gluing the Wing Halves

□ Step 2

Mix 1/2-ounce total (15ML) of 30-minute epoxy. Use an epoxy brush to apply a thin layer of epoxy to each of the wing roots as shown.



□ Step 3

Slide the remaining wing panel onto the wing tube.

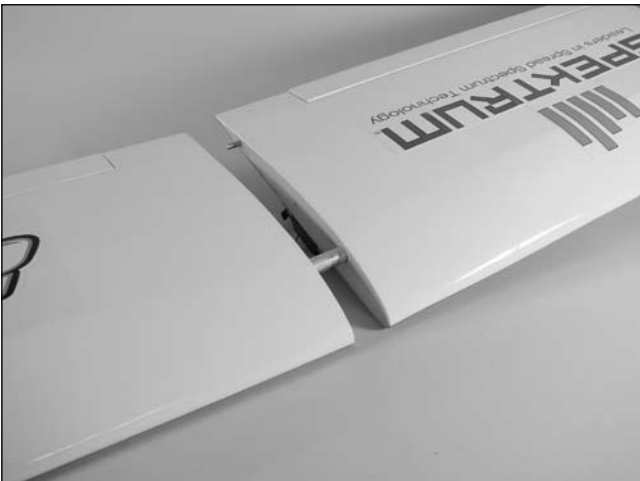

□ Step 4

As you slide the wing panels together, make sure the pin at the back (trailing edge) of the wing slides into the hole of the receiving wing panel. Slide the two wing panels tightly together so there is no gap between the two.



□ Step 5

Use a paper towel and rubbing alcohol to remove any epoxy that seeps from the joint between the two wing panels.



Section 5b: Optional: Gluing the Wing Halves

Step 6

Use tape (painter's tape suggested) to keep the two wing panels tight against each other until the epoxy is fully cured.

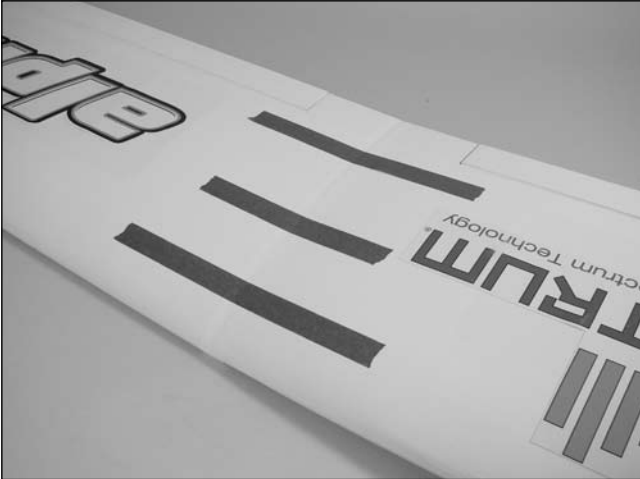

Step 7

After the epoxy has fully cured, use a covering iron to apply the covering to the joint of the wing. Use the orange covering on the bottom of the wing, and the white covering on the top of the wing.



Step 8

Connect the clevises from the aileron pushrods to the aileron control horns. The alignment of the ailerons will be checked later in this manual.

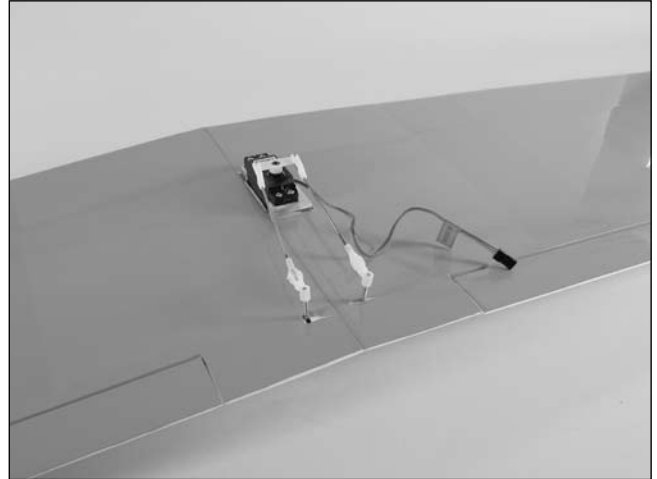

Section 6: Centering the Control Surfaces

Required Parts

- Assembled airframe

Required Tools and Adhesives

- Ruler

Checking the Elevator

Center the elevator stick and trim. If necessary, detach the clevis from the control horn and thread the clevis in or out on the elevator pushrod until the elevator is aligned with the stabilizer as shown. Remember to attach the clevis back in the center hole as described earlier in the manual.

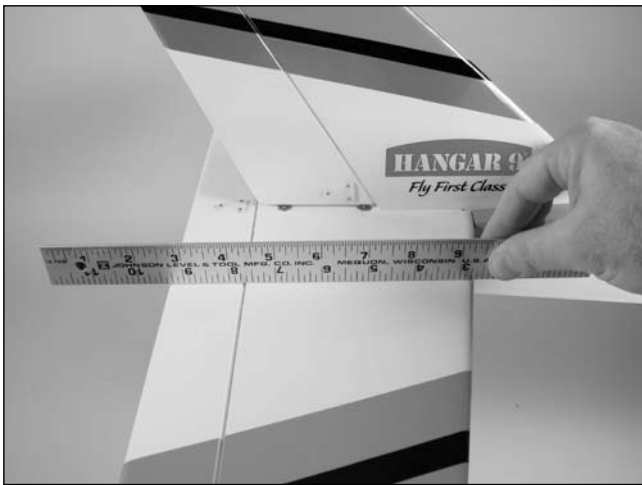

Checking the Rudder

Center the rudder stick and trim. If necessary, detach the clevis from the control horn and thread the clevis in or out on the rudder pushrod until the rudder is aligned with the fin as shown. Remember to attach the clevis back in the center hole as described earlier in the manual.

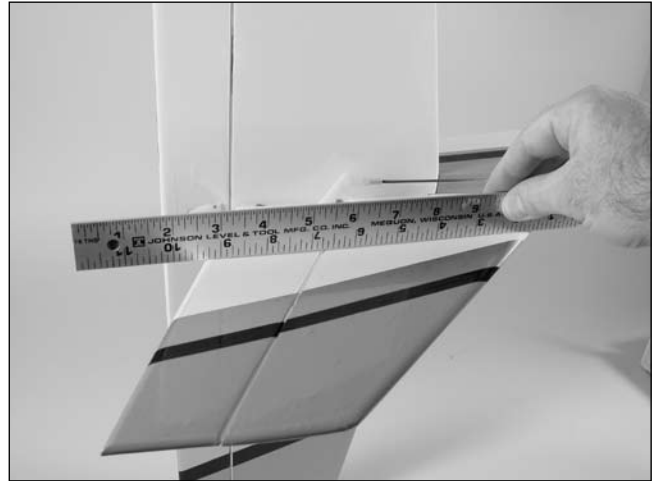

Checking the Ailerons

Center the aileron stick and trim. If necessary, detach the clevis from the control horn and thread the clevis in or out on each aileron pushrod until the ailerons are aligned with the wing as shown. Don't forget to align both ailerons at this time. Remember to attach the clevis back as described earlier in the manual.



Section 7: Wing Installation

Required Parts

- Wing assembly
- Fuselage assembly
- Rubber band (10)

□ Step 1

Locate the aileron extension that is inside the fuselage. Align the colors from the aileron servo lead with the extension so they match, then plug them together.

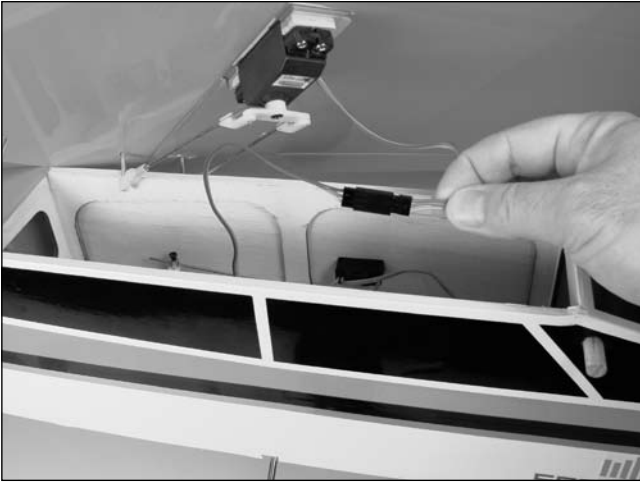

□ Step 2

Start securing the wing to the fuselage by installing two of the rubber bands.

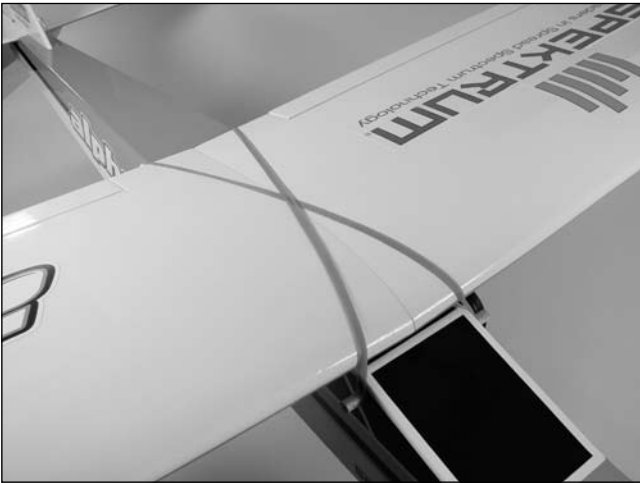

Hint: Always start with the cross rubber bands. This will keep the wing from twisting on the fuselage when installing the remaining rubber bands.

□ Step 3

Install a second set of rubber bands on the wing as shown.



□ Step 4

Continue installing a total of six or more of the rubber bands, alternating the direction of each set until they have all been installed.



Hint: Always end the rubber band installation by installing the cross rubber bands last. They will help in keeping all the other rubber bands in position on the wing dowels.

Hint: After flying, store your rubber bands in a bag with a small amount of baby powder. This will soak up the fuel that is on the rubber bands, making them last longer.

Section 8: Your Spektrum DX5e Radio System

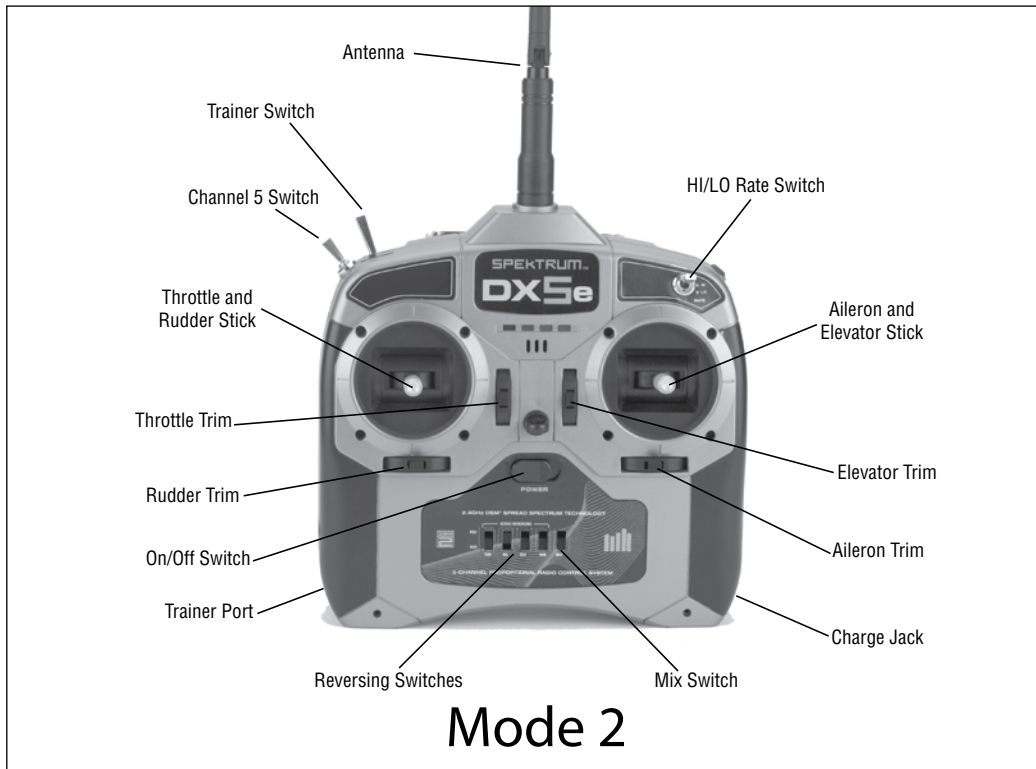

Section 9: Battery Installation



Remove the battery door and install 4 AA batteries noting the polarity of each corresponds with the diagram in the battery holder. Replace the battery door.

Note: Optional NiCd or NiMH 1.2-volt AA rechargeable batteries can also be used. A charge jack is located on the right side of the transmitter for convenient recharging.

Section 10: Digital Trims

The DX5e features digital trims. Each time a trimmer is moved the servo output will change one step. If the trimmer is held, the output will scroll in that direction until the trimmer is released or the output reaches its end.

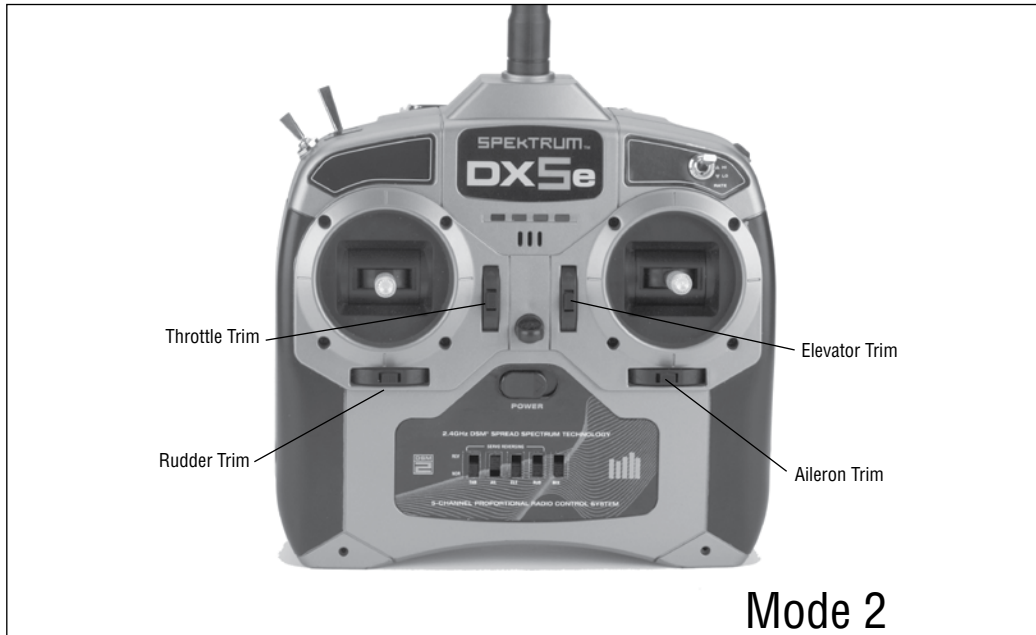

Section 11: Low Battery Alarm

When the battery voltage drops below 4.7 volts an alarm will sound and the voltage LEDs will flash.

Section 12: Trainer

The DX5e offers a Trainer function that allows the transmitter to operate as a master or slave. The trainer switch is located on the back left of the transmitter. When using the trainer function, plug the trainer cord (SPM6805) into the trainer port in both the master (controlling) and the slave (training) transmitters. The master transmitter must have the power turned on and the slave transmitter must have the power turned off.

Note: The DX5e trainer system is compatible with all JR® and Spektrum transmitters.

MASTER

The DX5e transmitter can be used as a master but the slave transmitter must have the same programming (i.e. reverse switch positions) as the master.

SLAVE

When using the DX5e transmitter as a slave with another DX5e, it's necessary to match all the reverse switch positions.

Section 13: Binding

Binding is the process of teaching the receiver the specific code of the transmitter so it will connect to that specific transmitter which it is bound to. The transmitter and receiver for your Alpha 40 RTF has already been bound, but this section has been included as reference. The AR500 receiver must be bound to the transmitter before it will operate. Once bound, the receiver will only connect to that transmitter.

□ Step 1

Remove the receiver cover in the fuselage to access the receiver.



□ Step 2

Temporarily remove the power plug from the battery/bind port in the receiver and plug it into the aileron extension. Plug the bind plug into the battery/bind port in the receiver where the power lead was.

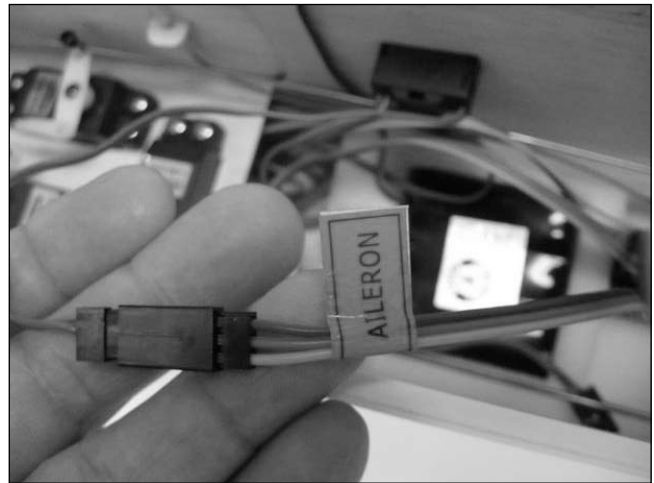

Section 13: Binding

□ Step 3

Turn on the receiver switch. The LED on the receiver should be flashing, indicating that the receiver is ready to bind.



□ Step 4

Establish the desired failsafe stick positions: normally low throttle and flight controls neutral.



□ Step 5

Pull and hold the trainer switch on the top of the transmitter while turning on the power switch. Turning on the switch will place the transmitter into bind mode. Within a few seconds the system should connect and the LEDs on the front of the transmitter will flash. The LED on the receiver should go solid indicating the system has connected. Once the system has connected release the trainer switch.



Note: Do not hold the trainer switch and turn on the power during normal operation or the receiver will become unbound and the entire binding process will have to be done again.

Section 13: Binding

□ Step 6

After the system is bound, turn off the power on the transmitter and receiver. Then remove the bind plug from the receiver and store it in a convenient place.



□ Step 7

Unplug the power lead from the aileron extension and plug it back into the power/bind port of the receiver. Turn on the transmitter and receiver to confirm that it is bound and working properly. Then replace the receiver cover in the fuselage.



Section 14: Checking the Control Surface Movement

Required Parts

- Transmitter
- Assembled airframe

The control direction has been set at the factory. This section has been provided in case any servos or control surfaces are replaced so the control direction can be checked at a later date.

Checking the Elevator

Check the movement of the elevator with the radio system. Pushing the elevator/aileron stick (right stick on the transmitter) forward will make the airplane elevator move down. This will cause the aircraft to pitch down while in flight.

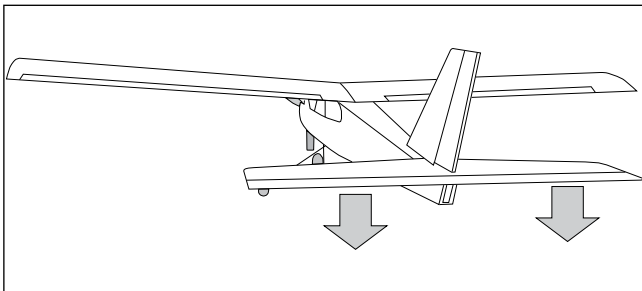

Check the movement of the elevator with the radio system. Pulling the elevator/aileron stick (right stick on the transmitter) back will make the airplane elevator move up. This will cause the aircraft to pitch up in flight.

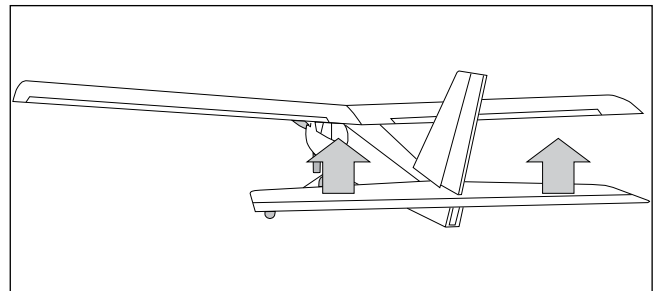

Section 14: Checking the Control Surface Movement

Checking the Ailerons

Check the movement of the aileron using the transmitter. When the aileron/elevator stick is moved left, the left aileron will move up and the right aileron will move down. This will cause the aircraft to roll left in flight.

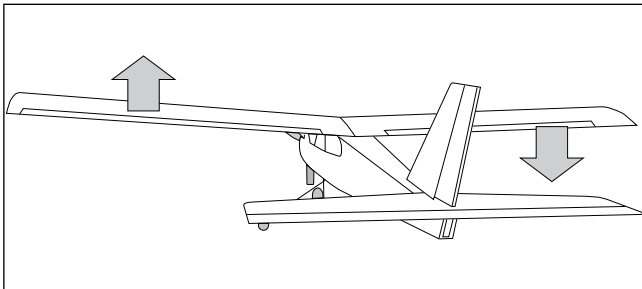

Check the movement of the aileron using the transmitter. When the elevator/aileron stick is moved right, the right aileron will move up and the left aileron will move down. This will cause the aircraft to roll right in flight.

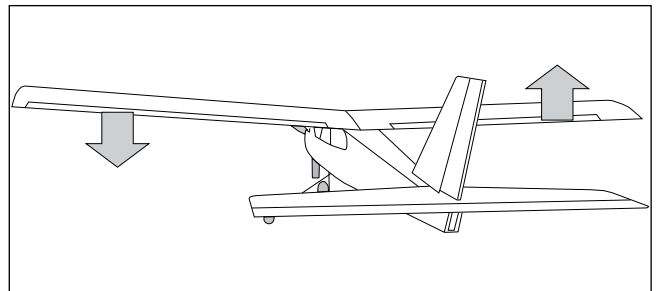

Section 14: Checking the Control Surface Movement

Checking the Rudder

Check the movement of the rudder using the transmitter. When the left stick is moved left, the rudder should also move left. This will cause the aircraft to turn left while on the ground and to yaw left while in flight.

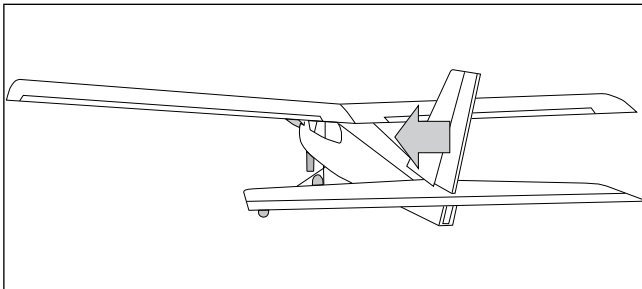

Check the movement of the rudder using the transmitter. When the rudder/throttle stick (left side of the transmitter) is moved right, the rudder should also move right. This will cause the aircraft to turn right while on the ground and to yaw right while in flight.

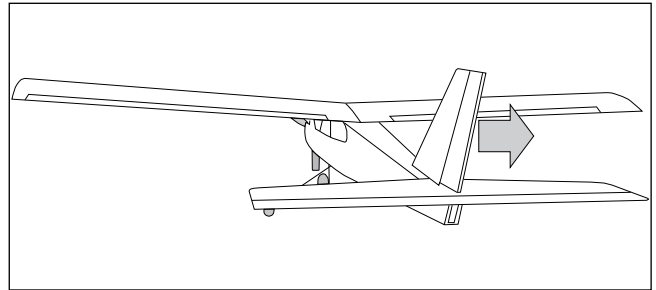

Section 14: Checking the Control Surface Movement

Reversing Direction of Flight Controls

If you find any of the control surfaces moving in the opposite direction (example shown below), you will need to use the **Servo Reversing** feature of your radio system. Follow the instructions included with your radio to change the servo reversing of the offending control surface.

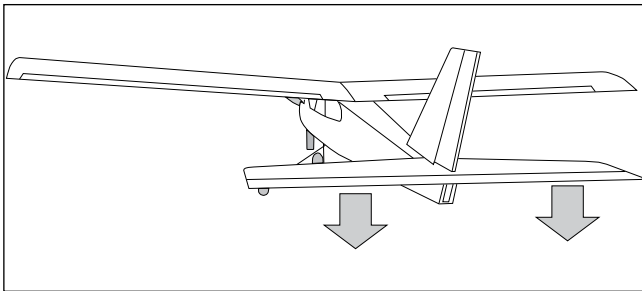

Wrong

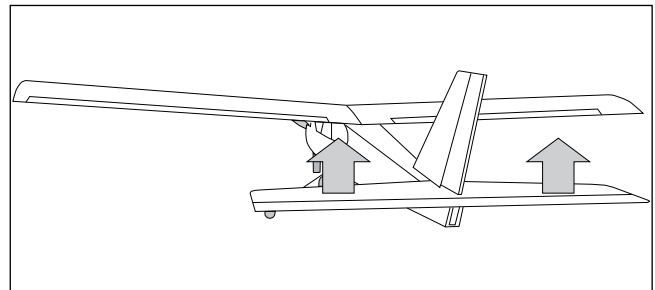

Right

Section 15: Hi/Lo Rate

The DX5e offers a high/low rate function on aileron, elevator and rudder. When the HI/LO rate switch is in the upper position or “HI” position, 100% travel is achieved on the aileron, elevator and rudder channels. When the switch is in the lower position, a reduced travel of 50% is achieved on the aileron, elevator and rudder channels. This is useful allowing the aircraft to have a high control rate (switch in the “HI” position) for aggressive maneuvers and a low control rate (switch in “LO” position) for smooth, precise maneuvers.



- High 100% rate on aileron, elevator and rudder
- Low 50% rate on aileron, elevator and rudder

Section 16: Setting the Control Throws

Required Parts

- Transmitter
- Assembled airframe

Required Tools and Adhesives

- Ruler

The control throws from the factory are preset in the transmitter. This section has been provided in case any servos or control surfaces are replaced so the control throws can be checked at a later date.

Rudder Throw

Use a ruler to check the amount of throw for the rudder. Move the rudder stick fully and check the measurements. Adjust the radio as necessary following the instructions provided with the radio to achieve the following measurement. The throw will measure:

Low Rate: 1/2-inch (13mm) (11 degrees)

High Rate: 7/8-inch (22mm) (20 degrees)

The throw is measured in both the right and left directions as shown below.

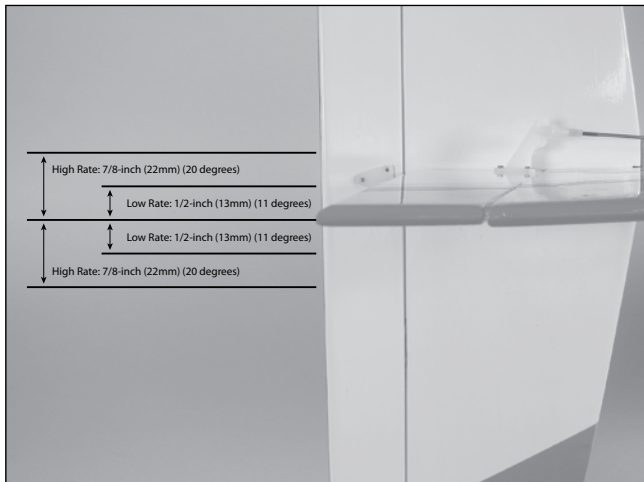

Note: The rudder throw is measured at the bottom of the rudder.

Aileron Throw

Use a ruler to check the amount of throw for the aileron. Move the aileron stick fully and check the measurements. Adjust the radio as necessary following the instructions provided with the radio to achieve the following measurement. The throw will measure:

Low Rate: 1/4-inch (6mm) (8 degrees)

High Rate: 3/8-inch (10mm) (14 degrees)

The throw is measured in both the up and down directions as shown below.

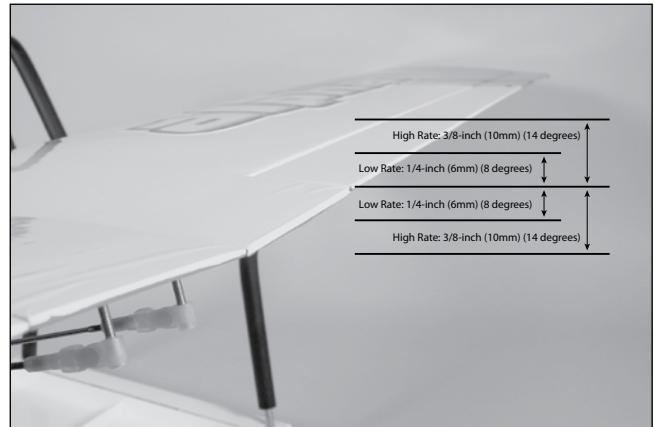

Elevator Throw

Use a ruler to check the amount of throw for the elevator. Move the elevator stick fully and check the measurements. Adjust the radio as necessary following the instructions provided with the radio to achieve the following measurement. The throw will measure:

Low Rate: 5/16-inch (8mm) (10 degrees)

High Rate: 1/2-inch (13mm) (16 degrees)

The throw is measured in both the up and down directions as shown below.

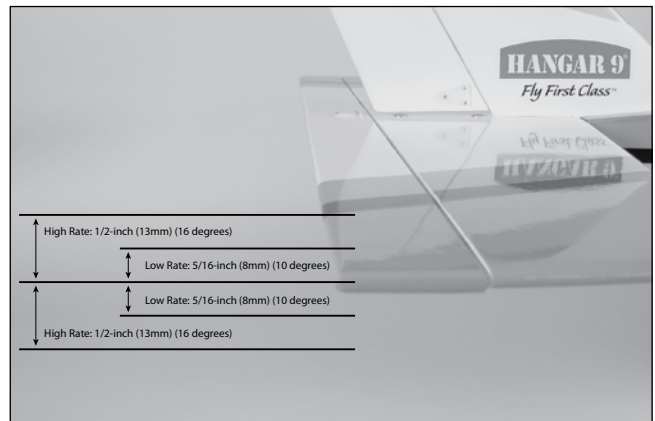

Section 17: Checking the Throttle Operation

Required Parts

- Fuselage assembly
- Transmitter

Throttle Closed

Move the throttle stick and trim down to the fully closed position as shown. The carburetor should close without binding the throttle servo. If the servo binds, you will need to adjust the clevis at the carburetor by threading it in or out to eliminate any binding.

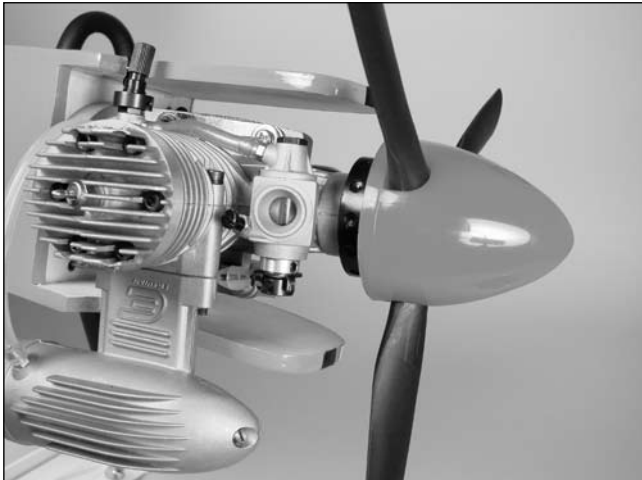
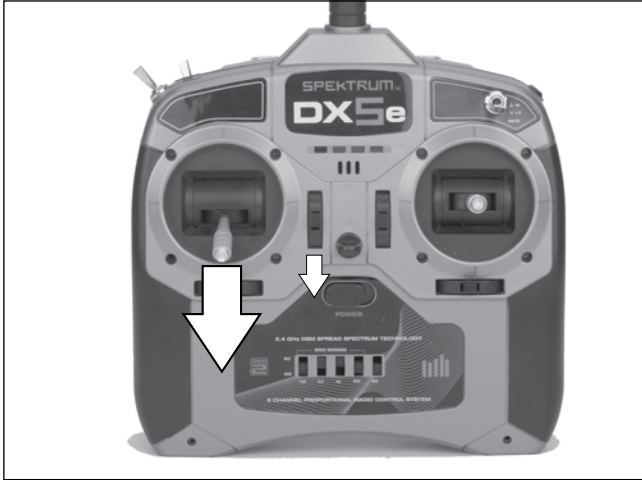

Throttle Open

Move the throttle stick and trim up, or the fully open, position as shown. The carburetor should open without binding the throttle servo. If the servo binds, you will need to adjust the clevis at the carburetor by threading it in or out to eliminate any binding.

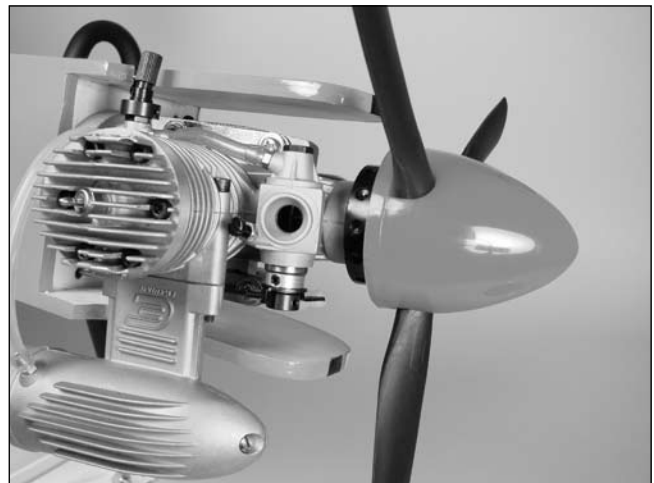

Section 17: Checking the Throttle Operation

Throttle Set to Idle

Move the throttle stick down to the fully closed position. Move the trim lever upward to open the carburetor roughly 1/16-inch (1.5mm). This will be the idle position for your engine. The idle will be fine-tuned at the field so the engine will idle reliably without stalling for slow flight and landing procedures.

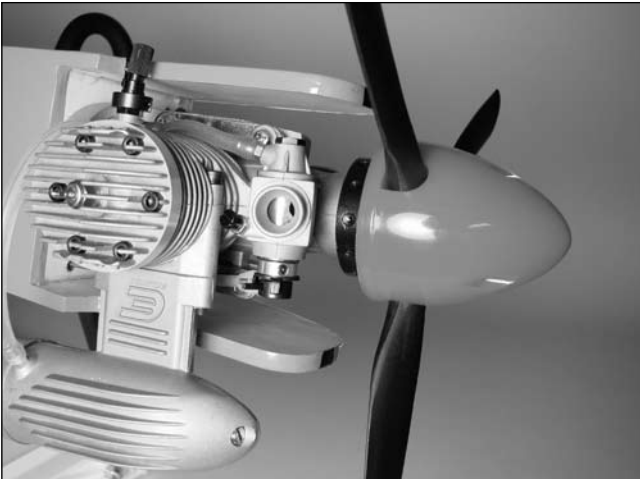
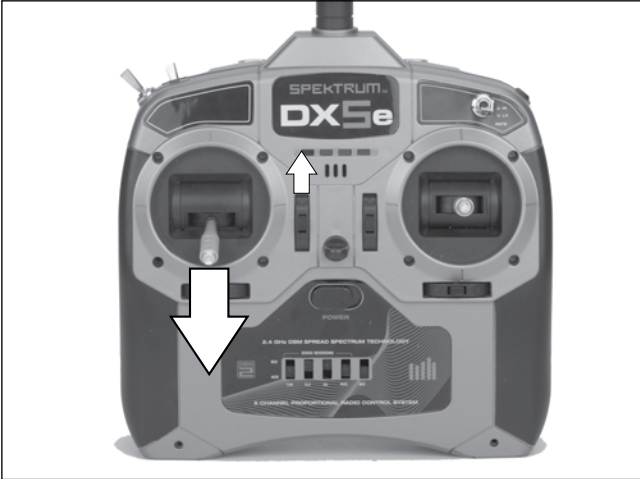

Section 18: Balancing Your Alpha RTF

In order for your Alpha 40 RTF to fly correctly, you will need to check the balance of the plane with the fuel tank empty. This is done by supporting the aircraft either using your fingers or by using a balancing stand. Not checking the balance can result in an aircraft that is difficult to fly, which can lead to the possibility of crashing your model.

□ Marking the Balance Point

The first step in balancing your Alpha 40 RTF is to mark the location for the balance point. The ideal balance point for the Alpha RTF is $2\frac{3}{4}$ –3 inches (70–76mm) back from the leading edge against the fuselage. If your plane is only slightly out of balance, try placing the balancing stand towards the nose or tail by $\frac{1}{8}$ -inch (3mm) and recheck the balance. If it looks good and sits level, then you're good to go.

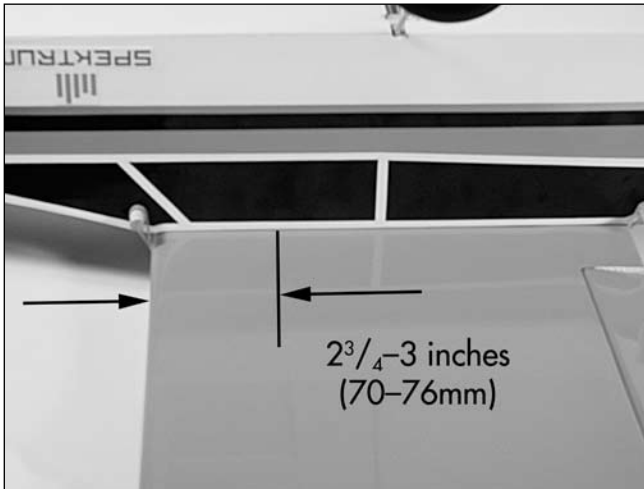

□ Lifting the Model and Observations

Make sure the Alpha RTF is balanced using either your fingers or a balancing stand. Place or lift the airplane so it is supported at the marks made in the previous step. The plane will rest level when balanced correctly. If not, weights must be added to correct any balancing problems.

Balanced Correctly

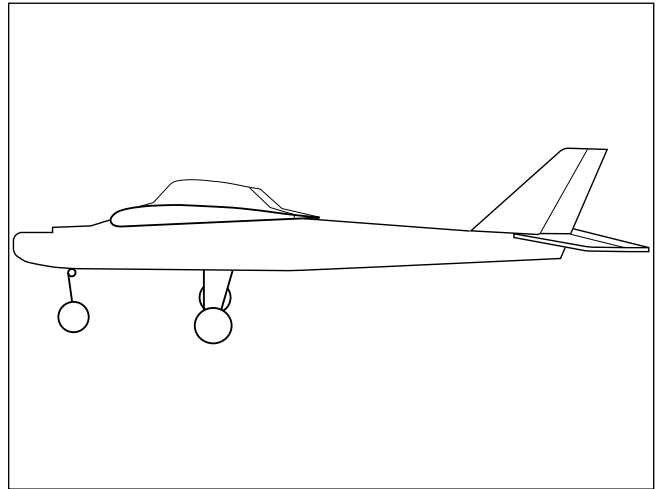

Nose Heavy – Add Weight to Tail

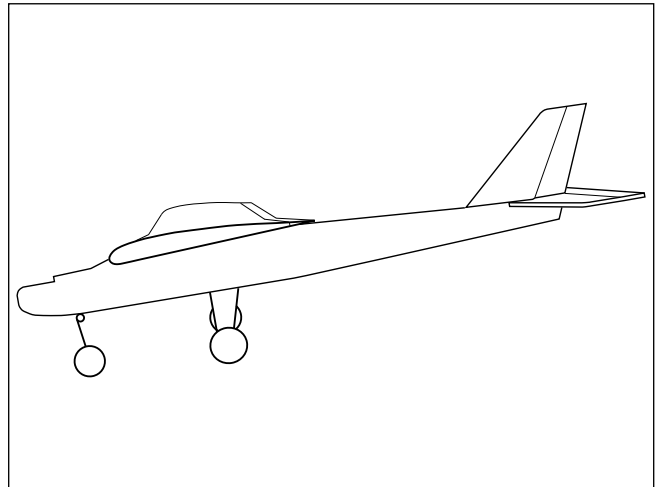

Tail Heavy – Add Weight to Nose

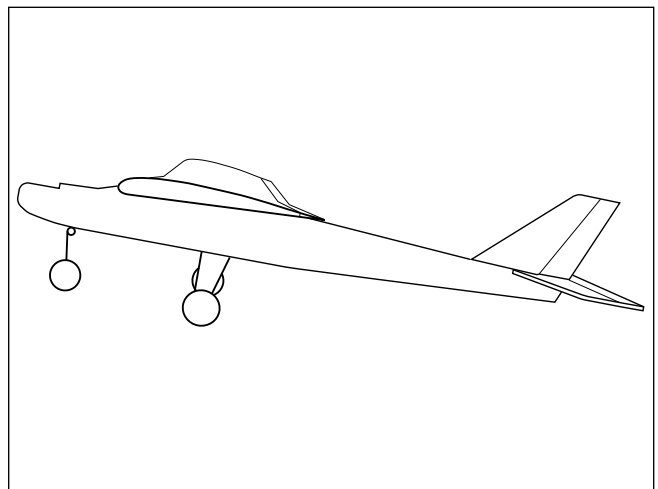

Section 18: Balancing Your Alpha RTF

Adding Weights to Correct the Balance

Due to manufacturing differences, it is possible that the Alpha 40 RTF may not be balanced properly. Weights can be added to either the tail or the nose of your Alpha RTF if it does not balance properly. Stick-on weights available at your local hobby store are the easiest to use, and come in sizes that are easily placed on your plane. Add just enough weight as necessary to balance your plane. Once the weight has been added, make sure it is secure and will not fall off in flight.



Section 19: Flight Preparations

Flight preparations must be checked each time you travel to the flying field. Because the Alpha RTF will encounter a variety of situations, it is best to keep an eye on the various components of your model to keep it in the best flying condition.

Checking the Frequency

When using a Spektrum radio system, follow the guidelines for use of DSM radio systems at your particular field.

Checking the Controls

Before starting your engine, check to make sure the controls are operating in the correct directions and the linkages and surfaces are not binding anywhere. Also look at the clevises and clevis retainers to make sure they are secure and will not come loose or fail in flight.

Fueling the Alpha RTF

Fill the fuel tank with the proper fuel. Fill the tank by connecting the fuel pump to the line going to the needle valve. Disconnect the fuel line attached to the pressure fitting of the muffler; your tank is full when fuel begins to run out of the pressure line. Reconnect the fuel lines to the needle valve assembly and muffler.

Note: It is very important to reconnect the lines to the correct place. If they are reconnected incorrectly, the engine will not run properly.

Section 20: How to Range Test the DX5e

Before each flying session, and especially with a new model, it is important to perform a range check. The DX5e incorporates a range testing system which, when placed in the RANGE CHECK mode with the trainer switch activated and held, reduces the output power, allowing a range check.

RANGE TESTING THE DX5E

Step 1

With the model resting on the ground, stand 30 paces (approx. 90 feet) away from the model.

Step 2

Face the model with the transmitter in your normal flying position. Pull and hold the trainer switch while toggling the HI/LO Rate Switch four times. The LEDs will flash and the alarm will sound indicating the system is in range check mode.

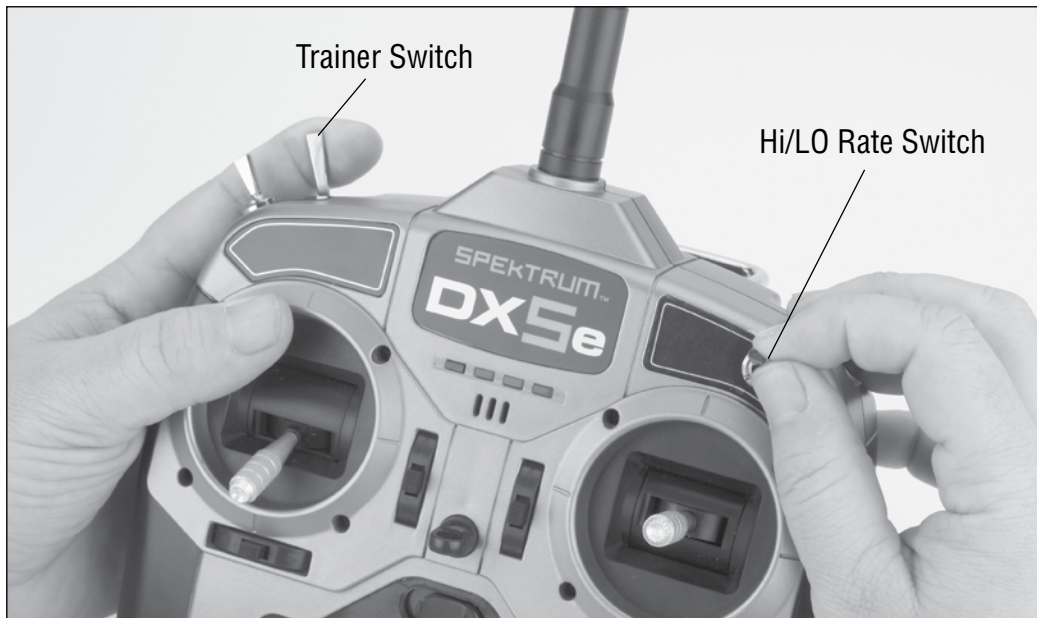

Step 3

You should have total control of the model with the trainer switch pulled at 30 paces (90 feet).

Step 4

If control issues exist, call the Horizon Support Team at 1 (877) 504-0233 or go to horizonhobby.com to find a local Spektrum distributor in your country for service.

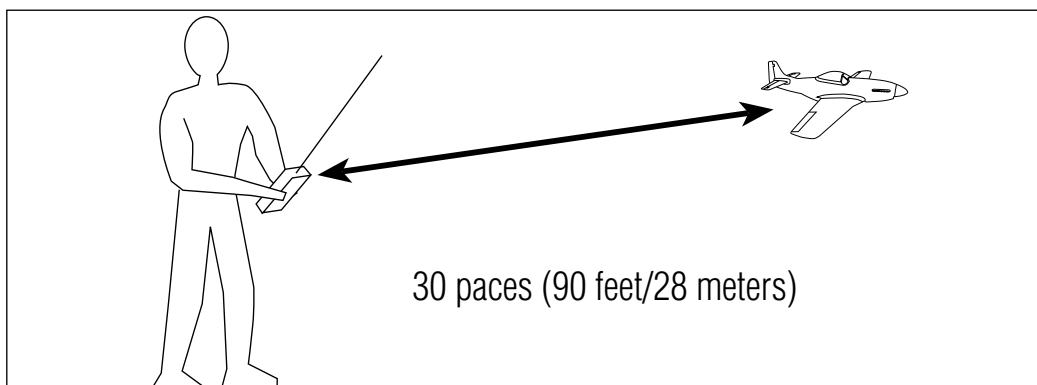

Section 21: Starting and Adjusting the Evolution Engine

FUEL

The Evolution Engine comes adjusted from the factory. We recommend using high quality Cool Power Omega, Hangar 9® AeroBlend™ or Power Master fuels containing 10 to 15% Nitro. The Evolution Engine has been test run using these fuels. If another brand of fuel is used, it may be necessary to slightly adjust the needle valves to compensate for the differences in fuel.

GLOW PLUG

The Evolution Engine comes with a specially designed “Super Plug” that prevents idle and transition flameouts. The plug’s unique shape directs incoming fuel/air mixture away from the plug element. When replacing the plug, be sure to replace it with another Evolution Super Plug (EVOGP1).

STARTING THE ENGINE

Step 1

Fill the tank with the above-mentioned 10 or 15% fuel.

Step 2

Reattach the fuel lines, making sure the vent and clunk line are attached to the fuel nipple and the muffler pressure nipple.

Caution: Do not attach the glow driver yet.

Step 3

With the throttle fully open, place your thumb over the carburetor and rotate the prop clock-wise through 6 complete revolutions, thus priming the engine.

Step 4

Close the throttle to the idle position and have a helper hold your airplane.

Step 5

Attach the glow driver.

Step 6

Turn the engine over using an electric starter. The engine should fire within seconds of applying the starter.

Step 7

Allow the engine to idle for 30 seconds. Adjust the throttle trim if necessary to achieve a constant slow idle.

Step 8

With the glow driver still attached and a helper securely holding the airplane, advance the throttle smoothly to full throttle. The engine will transition to full rpm.

Step 9

Reduce the throttle to idle and remove the glow driver.

NEEDLE LIMITERS

In some conditions: Due to high altitudes, extreme temperatures, etc., it may be necessary to slightly adjust the idle and high-speed needle valves. The high- and low-speed needles have limiters that prevent over-adjustment.



Section 21: Starting and Adjusting the Evolution Engine

If your engine starts from the above procedure, but won't reliably continue to run with the glow driver removed, follow the steps above right.

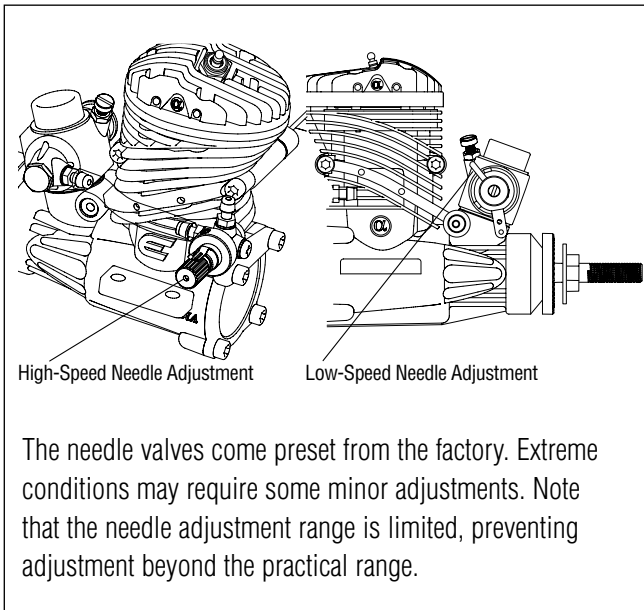

STEP 1: HIGH-SPEED NEEDLE ADJUSTMENT

With the engine running, advance the throttle to full throttle while a helper securely holds your airplane. Carefully pinch and release the fuel line to temporarily restrict the fuel flow.

Caution: Do not reach over the propeller while the engine is running.

Correct: If the high-speed needle adjustment is correct, the engine will increase rpm slightly (about 300 rpm) and then die.

Too Rich: If the engine increases a lot (1,000 rpm or greater), the high-speed needle is too rich and must be leaned or turned clockwise.

Too Lean: If the engine doesn't increase rpm and simply dies, the high-speed needle is lean and must be richened or turned counterclockwise.

STEP 2: LOW-SPEED NEEDLE ADJUSTMENT

The low-speed or idle needle valve, included with the SetRight™ assembly, is preadjusted at the factory for best performance. It may be necessary to fine-tune the low-speed adjustment using the following procedure:

□ Step 1

Start the engine and let it warm up, prior to attempting any adjustments. Make sure that the high-speed adjustment process is complete before attempting to adjust the low-speed needle valve.

□ Step 2

Close the throttle slowly. You will adjust the low-speed needle setting by rotating the SetRight adjustment bar clockwise to lean the engine and counterclockwise to richen the engine.

Caution: Do not attempt to adjust the low-speed needle valve while the engine is running.

□ Step 3

The fuel mixture should be adjusted as follows: The fuel mixture is too rich if, when opening the throttle rapidly, the engine emits smoke and "stutters" or "stumbles." Correct this by rotating the SetRight adjustment bar clockwise in small increments. Continue this process until the engine transitions smoothly from low rpm idle to high rpm without hesitation upon opening the throttle rapidly.

□ Step 4

The fuel mixture may be too lean if the engine stops at the lowest idle position or it stops when the throttle is rapidly opened from the idle position. Correct this by rotating the SetRight adjustment bar counterclockwise in small increments until the engine transitions smoothly without hesitation upon opening the throttle rapidly from idle.

Section 21: Starting and Adjusting the Evolution Engine

TROUBLESHOOTING GUIDE

Engine Won't Fire

- Glow starter not charged
 - Charge glow starter
- Glow plug burnt out
 - Replace glow plug
- No fuel is getting to the carburetor
 - Check tank, fuel lines reversed
- The starter is reversed
 - Reverse the polarity on the starter cables

Engine Quits Repeatedly

- Needles need adjusting
 - See adjustment procedure
- Bad or old fuel
 - Replace with fresh fuel
- Worn out glow plug
 - Replace with new HAN3006 super plug

Engine Runs Inconsistently

- Hole in fuel line
 - Replace fuel line
- Bad or old fuel
 - Replace with fresh fuel

ENGINE MAINTENANCE

After each flying session:

Step 1

Fully drain the fuel from the tank.

Step 2

Start the engine and run it until the fuel is completely run out of the engine.

Step 3

Try starting the engine three more times or until it will no longer fire. This gets all the fuel out of the engine.

At the end of each flying session, place several drops (about 10) of after run oil (Evolution Engine's Blue Block Rust Inhibitor, EVOX1000) should be applied into the carburetor and the engine should be turned over for a few seconds with the starter. This will prevent rust and corrosion.

Section 22: Maintaining Your Alpha 40 RTF

The following is a check list that you should follow every time you have completed a flying session with your Alpha 40 RTF. Doing so will keep your aircraft in the best flying condition.

Clean Up

After any flying session with your Alpha 40 RTF, you will want to clean it up before loading it into your vehicle to head home. Use glass cleaner and a paper towel to wipe down the exterior of your plane, removing the fuel residue. Remember a clean plane will last longer since the fuel won't be allowed to soak into any exposed wood.

Checking the Propeller

Check to make sure the propeller is tightly secured to the engine. If not, remove the spinner and use an adjustable wrench to tighten it back down. If you have had any not-so-great landings, you will want to inspect the propeller for any damage. Small nicks and scratches can quickly become fractures, causing the propeller to be unsafe for flight. Always carry a few spare propellers so a damaged propeller can be replaced at the field, increasing your flying time per trip to the field.

Checking the Clevises

Inspect the aileron, elevator and rudder clevises to make sure they are connected and in good working order. If you find a clevis that is showing signs of wear or is broken, replace it with a new clevis. Also check the nylon connectors at the servo for any wear or damage. If they look worn or in bad shape, replace them as well.

Checking the Control Horns

Inspect the control horns to make sure they have not crushed the wood of the control surface. If so, remove the control horn screws to remove the control horn. Place 2–3 drops of thin CA into each of the screw holes. In addition, use a T-pin to poke small holes in the covering in the area where the control horn mounts, then saturate the area with thin CA. This will harden the wood and give the control horns a solid surface to be mounted to.

Checking the Wheel Collars

Check the setscrews on the main and nose wheel collars, as well as the wheel collars on the elevator linkage, to make sure they are not loose. Use a hex wrench or Phillips screwdriver as necessary to tighten the setscrews. It is suggested if they loosen frequently to remove them, apply threadlock to the setscrews, then secure the wheel collars back into position.

Check the Muffler Bolts

Use a 2.5mm hex wrench to make sure the bolts holding the muffler onto the engine are tight and have not vibrated loose during flight.

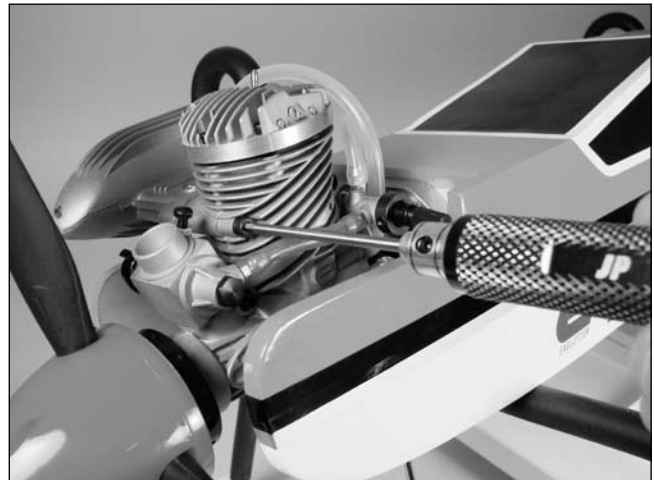

Section 22: Maintaining Your Alpha 40 RTF

☐ Check the Engine Mount Bolts

Remove the spinner and propeller from the engine. Remove the exhaust stacks from the fuselage, and then remove the cowling from the fuselage. Remove the muffler from the engine, and then use a Phillips screwdriver to make sure the four bolts securing the engine to the mount are tight.

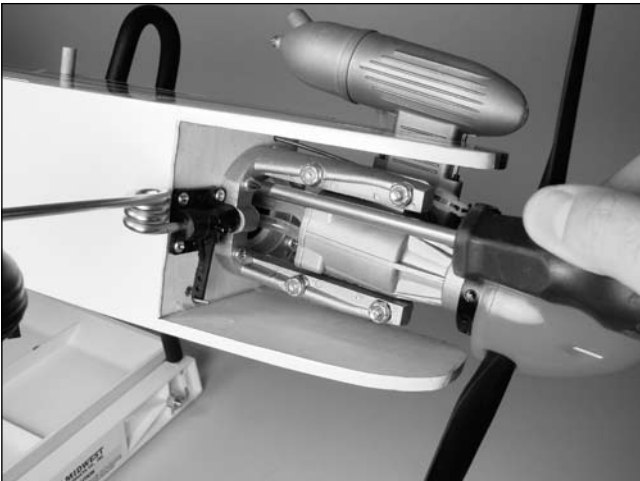
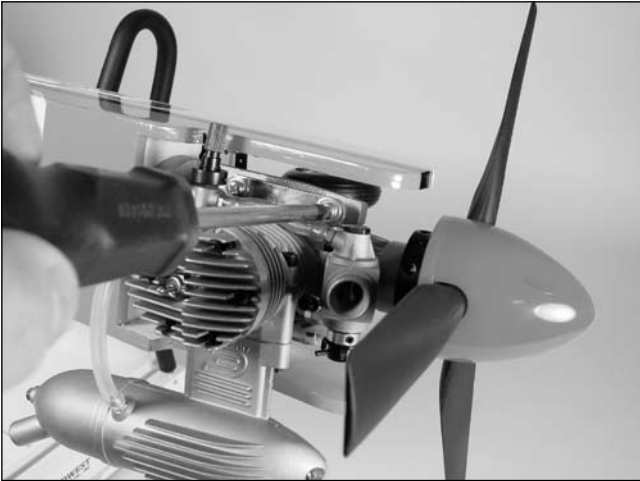

☐ Adjusting the Steering Trim

When adjusting the steering trim, do not use the trim on the transmitter. The rudder trim on the transmitter is used to trim the rudder while the aircraft is in flight. If you find your model does not track straight during taxi, loosen the screw and adjust the position of the nose wheel. Remember to tighten the screw as soon as you have changed the position of the nose wheel.

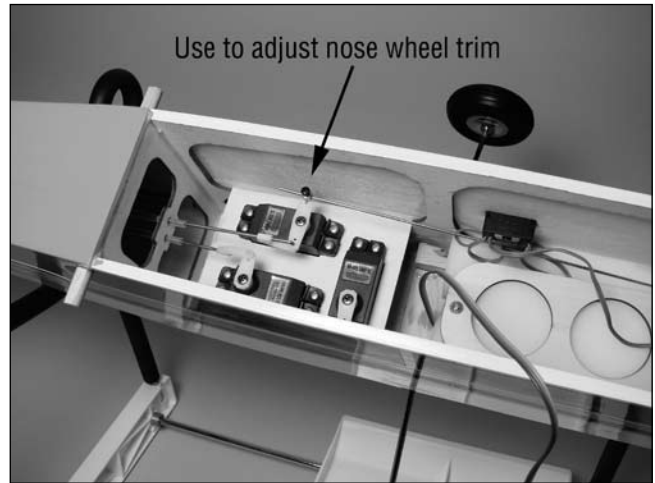

Safety Do's and Don'ts for Pilots

- Ensure that your batteries have been properly charged prior to your initial flight.
 - Keep track of the time the system is turned on so you will know how long you can safely operate your system.
 - Perform a ground range check prior to the initial flight of the day. See the “Daily Flight Checks Section” for information.
 - Check all control surfaces prior to each takeoff.
 - Do not fly your model near spectators, parking areas or any other area that could result in injury to people or damage of property.
- Do not fly during adverse weather conditions. Poor visibility can cause disorientation and loss of control of your aircraft. Strong winds can cause similar problems.
 - Do not point the transmitter antenna directly toward the model. The radiation pattern from the tip of the antenna is inherently low.
 - Do not take chances. If at any time during flight you observe any erratic or abnormal operation, land immediately and do not resume flight until the cause of the problem has been ascertained and corrected. Safety can never be taken lightly.

Daily Flight Checks

Step 1

Check the battery voltage on both the transmitter and the receiver battery packs. Do not fly below 4.3V on the transmitter or below 4.7V on the receiver. To do so can crash your aircraft.

Note: When you check these batteries, ensure that you have the polarities correct on your expanded scale voltmeter.

Step 2

Check all hardware (linkages, screws, nuts, and bolts) prior to each day's flight. Be sure that binding does not occur and that all parts are properly secured.

Step 3

Ensure that all surfaces are moving in the proper manner.

Step 4

Perform a ground range check before each day's flying session.

Step 5

Prior to starting your aircraft, turn off your transmitter, then turn it back on. Do this each time you start your aircraft. If any critical switches are on without your knowledge, the transmitter alarm will warn you at this time.

Step 7

Check that all trim levers are in the proper location.

Step 7

All servo pigtails and switch harness plugs should be secured in the receiver. Make sure that the switch harness moves freely in both directions.

Glossary of Terms

Ailerons: Each side of this airplane has a hinged control surface (aileron), located on the trailing edge of the wing. Move the aileron stick on the transmitter left, the left aileron moves up and the right aileron moves down. Moving the left aileron up causes more drag and less lift, causing the left wing to drop down. When the right aileron moves down, more lift is created, causing the right wing to rise. This interaction causes the airplane to turn or roll to the left. Perform the opposite actions, and the airplane will roll to the right.

Clevis: The clevis connects the wire end of the pushrod to the control horn of the control surface. Being a small clip, the clevis has fine threads so that you can adjust the length of the pushrod.

Control Horn: This arm connects the control surface to the clevis and pushrod.

Dihedral: The degree of angle (V-shaped bend) at which the wings intersect the fuselage is called dihedral. More dihedral gives an airplane more aerodynamic stability. Some sailplanes and trainer planes with large dihedral dispense with ailerons and use only the rudder to control the roll and yaw.

Elevator: The hinged control surface on the back of the stabilizer that moves to control the airplane's pitch axis. Pulling the transmitter's control stick toward the bottom of the transmitter moves the elevator upward, and the airplane begins to climb. Push the control stick forward, and the airplane begins to dive.

Fuselage: The main body of an airplane.

Hinge: Flexible pieces used to connect the control surface to the flying surface. All hinges must be glued properly and securely to prevent the airplane from crashing. (This has already been done for you on the Alpha Advanced trainer.)

Horizontal Stabilizer: The horizontal flying surface of the tail gives the airplane stability while in flight.

Leading Edge: The front of a flying surface.

Main Landing Gear: The wheel and gear assembly the airplane uses to land. It is attached to the bottom of the fuselage.

Nose Gear: The part of the landing gear that is attached to the nose of the fuselage. The nose gear is usually connected to the rudder servo to help you steer the airplane on the ground.

Pitch Axis: The horizontal plane on which the airplane's nose is raised or lowered. By moving the elevator, you can raise the airplane's nose above the pitch axis (climb) or lower it below the pitch axis (dive).

Pushrod: The rigid mechanism that transfers movement from the servo to the control surface.

Roll Axis: The horizontal plane on which the airplane's wings are raised or lowered. By adjusting the ailerons, you can drop a wing tip below the roll axis and cause the airplane to bank or roll.

Rudder: The hinged control surface on the vertical stabilizer that controls the airplane's yaw. Moving the rudder to the left causes the airplane to yaw left; moving the rudder to the right causes it to yaw right.

Servo: The servo transforms your ground commands into physical adjustments of the airplane while it's in the air.

Servo Output Arm: A removable arm or wheel connecting the servo to the pushrod (also called servo horn).

Spinner: Term describing the nose cone that covers the propeller hub.

Threadlock: A liquid that solidifies; used to prevent screws from loosening due to vibration.

Torque Rods: Inserted into the ailerons, these rigid wire rods run along the wing's trailing edge, then bend downward and connect to the pushrod.

Vertical Stabilizer: The vertical flying surface of the tail gives the airplane stability while in flight.

Wheel Collar: The round, metal retaining piece that anchors wheels in place on the wheel axle.

Wing: The lifting surface of an airplane.

Yaw Axis: The vertical plane through which the airplane's nose rotates as it yaws to the left or to the right. The rudder controls the yaw axis.

2008 Official AMA National Model Aircraft Safety Code

GENERAL

1. A model aircraft shall be defined as a non-human-carrying device capable of sustained flight in the atmosphere. It shall not exceed limitations established in this code and is intended to be used exclusively for recreational or competition activity.
2. The maximum takeoff weight of a model aircraft, including fuel, is 55 pounds, except for those flown under the AMA Experimental Aircraft Rules.
3. I will abide by this Safety Code and all rules established for the flying site I use. I will not willfully fly my model aircraft in a reckless and/or dangerous manner.
4. I will not fly my model aircraft in sanctioned events, air shows, or model demonstrations until it has been proven airworthy.
5. I will not fly my model aircraft higher than approximately 400 feet above ground level, when within three (3) miles of an airport without notifying the airport operator. I will yield the right-of-way and avoid flying in the proximity of full-scale aircraft, utilizing a spotter when appropriate.
6. I will not fly my model aircraft unless it is identified with my name and address, or AMA number, inside or affixed to the outside of the model aircraft. This does not apply to model aircraft flown indoors.
7. I will not operate model aircraft with metal-blade propellers or with gaseous boosts (other than air), nor will I operate model aircraft with fuels containing tetranitromethane or hydrazine.
8. I will not operate model aircraft carrying pyrotechnic devices which explode burn, or propel a projectile of any kind. Exceptions include Free Flight fuses or devices that burn producing smoke and are securely attached to the model aircraft during flight. Rocket motors up to a G-series size may be used, provided they remain firmly attached to the model aircraft during flight. Model rockets may be flown in accordance with the National Model Rocketry Safety Code; however, they may not be launched from model aircraft. Officially designated AMA Air Show Teams (AST) are authorized to use devices and practices as defined within the Air Show Advisory Committee Document.
9. I will not operate my model aircraft while under the influence of alcohol or within eight (8) hours of having consumed alcohol.
10. I will not operate my model aircraft while using any drug which could adversely affect my ability to safely control my model aircraft.
11. Children under six (6) years old are only allowed on a flightline or in a flight area as a pilot or while under flight instruction.
12. When and where required by rule, helmets must be properly worn and fastened. They must be OSHA, DOT, ANSI, SNELL or NOCSAE approved or comply with comparable standards.

2008 Official AMA National Model Aircraft Safety Code

Radio Control

1. All model flying shall be conducted in a manner to avoid over flight of unprotected people.
2. I will have completed a successful radio equipment ground-range check before the first flight of a new or repaired model aircraft.
3. I will not fly my model aircraft in the presence of spectators until I become a proficient flier, unless I am assisted by an experienced pilot.
4. At all flying sites a line must be established, in front of which all flying takes place. Only personnel associated with flying the model aircraft are allowed at or in front of the line. In the case of airshows demonstrations straight line must be established. An area away from the line must be maintained for spectators. Intentional flying behind the line is prohibited.
5. I will operate my model aircraft using only radio-control frequencies currently allowed by the Federal Communications Commission (FCC). Only individuals properly licensed by the FCC are authorized to operate equipment on Amateur Band frequencies.
6. I will not knowingly operate my model aircraft within three (3) miles of any preexisting flying site without a frequency-management agreement. A frequency-management agreement may be an allocation of frequencies for each site, a day-use agreement between sites, or testing which determines that no interference exists. A frequency-management agreement may exist between two or more AMA chartered clubs, AMA clubs and individual AMA members, or individual AMA members. Frequency-management agreements, including an interference test report if the agreement indicates no interference exists, will be signed by all parties and copies provided to AMA Headquarters.
7. With the exception of events flown under official AMA rules, no powered model may be flown outdoors closer than 25 feet to any individual, except for the pilot and located at the flight line.
8. Under no circumstances may a pilot or other person touch a model aircraft in flight while it is still under power, except to divert it from striking an individual.
9. Radio-controlled night flying is limited to low-performance model aircraft (less than 100 mph). The model aircraft must be equipped with a lighting system which clearly defines the aircraft's attitude and direction at all times.
10. The operator of a radio-controlled model aircraft shall control it during the entire flight, maintaining visual contact without enhancement other than by corrective lenses that are prescribed for the pilot. No model aircraft shall be equipped with devices which allow it to be flown to a selected location which is beyond the visual range of the pilot.



Fly First Class™



© 2008 Horizon Hobby, Inc.
4105 Fieldstone Road
Champaign, Illinois 61822
(877) 504-0233
horizonhobby.com