

Gee Bee

ART

INSTRUCTION MANUAL

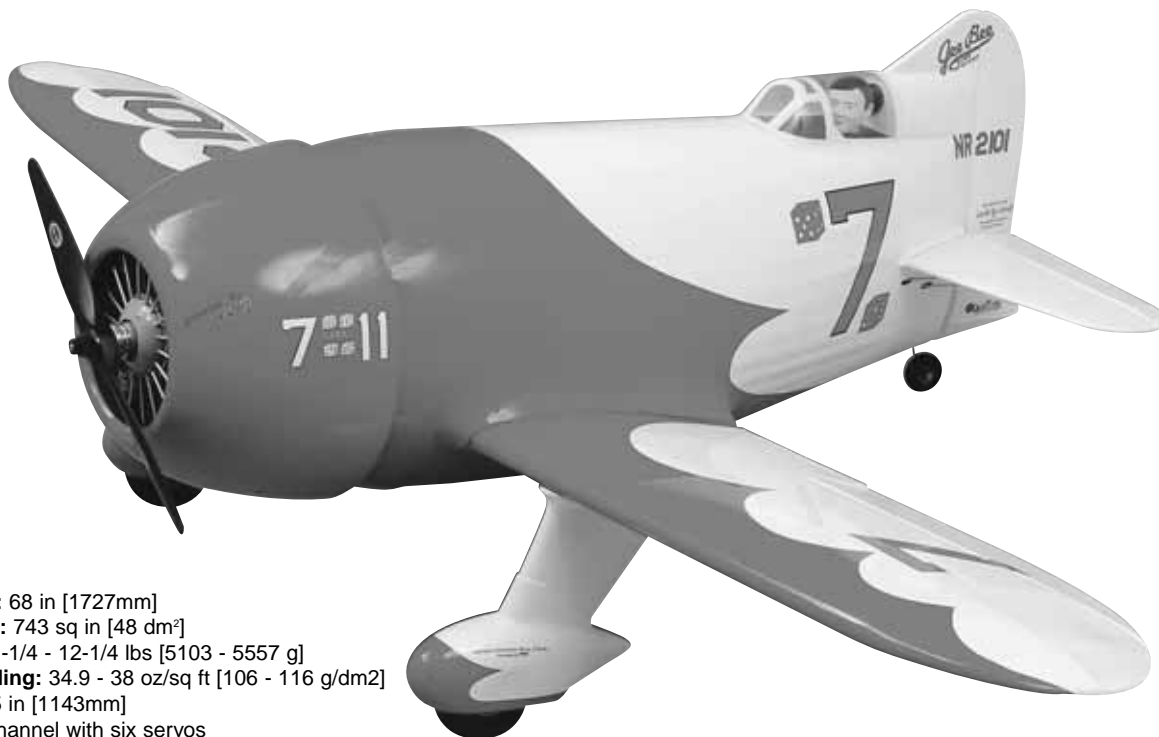

Wingspan: 68 in [1727mm]
Wing Area: 743 sq in [48 dm²]
Weight: 11-1/4 - 12-1/4 lbs [5103 - 5557 g]
Wing Loading: 34.9 - 38 oz/sq ft [106 - 116 g/dm²]
Length: 45 in [1143mm]
Radio: 4 channel with six servos
Engine: .91 - 1.08 cu in [15cc - 18cc] two-stroke, 1.20 cu in [20 cc] four-stroke

WARRANTY

Great Planes® Model Manufacturing Co. guarantees this kit to be free from defects in both material and workmanship at the date of purchase. This warranty does not cover any component parts damaged by use or modification. **In no case shall Great Planes' liability exceed the original cost of the purchased kit.** Further, Great Planes reserves the right to change or modify this warranty without notice.

In that Great Planes has no control over the final assembly or material used for final assembly, no liability shall be assumed nor accepted for any damage resulting from the use by the user of the final user-assembled product. By the act of using the user-assembled product, the user accepts all resulting liability.

If the buyer is not prepared to accept the liability associated with the use of this product, the buyer is advised to return this kit immediately in new and unused condition to the place of purchase.

READ THROUGH THIS MANUAL BEFORE STARTING CONSTRUCTION. IT CONTAINS IMPORTANT WARNINGS AND INSTRUCTIONS CONCERNING THE ASSEMBLY AND USE OF THIS MODEL.



Champaign, Illinois
(217) 398-8970, Ext 5
airsupport@greatplanes.com

TABLE OF CONTENTS

INTRODUCTION	2
Scale Competition	3
SAFETY PRECAUTIONS	3
DECISIONS YOU MUST MAKE	4
Radio Equipment	4
Engine Recommendations	4
ADDITIONAL ITEMS REQUIRED	4
Hardware and Accessories	4
Adhesives and Building Supplies	4
Covering Tools	4
Optional Supplies and Tools	4
IMPORTANT BUILDING NOTES	4
ORDERING REPLACEMENT PARTS	5
KIT CONTENTS	6
PREPARATIONS	7
ASSEMBLE THE FUSELAGE STAND	7
BUILD THE WING	8
Install the Ailerons	8
Install the Aileron Servos and Pushrods	9
Join the Wings	10
Install the Landing Gear	11
Install the Belly Pan	13
ASSEMBLE THE FUSELAGE	14
Install the Engine and Throttle Servo	14
Install the Fuel Tank	17
Install the Cowl Ring, Cowl and Dummy Engine	18
Mount the Stab, Elevator, Rudder and Tailwheel	22
Install the Elevator and Rudder Servos, Radio System and Pushrods	24
Finishing Touches	28
GET THE MODEL READY TO FLY	28
Check the Control Directions	28
Set the Control Throws	29
Balance the Model (C.G.)	29
Balance the Model Laterally	30
PREFLIGHT	30
ENGINE SAFETY PRECAUTIONS	31
AMA SAFETY CODE	31
CHECKLIST	32
FLYING	32
Fuel Mixture Adjustments	32
Takeoff	33
Flight	33
Aerobatics	33
Engine Out Situation	33
Landing	33
ENGINE MOUNT TEMPLATES	35

INTRODUCTION

Since its introduction, the Gee Bee has caught the imagination of the full-scale aviation enthusiast and modelers alike. The full-scale plane was notorious for its unpredictable flight characteristics. Great Planes is proud to introduce our version that has the characteristic look of the full scale Gee

Bee without the unpredictable flight characteristics. You will enjoy flying this impressive model and showing off its aerobatic capabilities to everyone at the field.

For the latest technical updates or manual corrections to the Gee Bee visit the web site listed below and select the Great Planes Gee Bee ARF. If there is new technical information or changes to this model, a "tech notice" box will appear in the upper left corner of the page.

<http://www.greatplanes.com/airplanes/index.html>

Scale Competition

Though the Great Planes Gee Bee is an ARF and may not have the same level of detail as an "all-out" scratch-built competition model, it is a scale model nonetheless and is therefore eligible to compete in the Fun Scale class in AMA competition. (We receive many favorable reports of Great Planes ARFs in scale competition!) In Fun Scale, the "builder of the model" rule does not apply. To receive the five points for scale documentation, the only proof required that a full size aircraft of this type in this paint/markings scheme did exist is a single sheet such as a kit box cover from a plastic model, a photo, or a profile painting, etc. If the photo is in black and white, other written documentation of color must be provided. Contact the AMA for a rule book with full details.

If you would like photos of the full-size Gee Bee for scale documentation, or if you would like to study the photos to add more scale details, photo packs are available from:

Bob's Aircraft Documentation
3114 Yukon Ave
Costa Mesa, CA 92626

Telephone: (714) 979-8058
Fax: (714) 979-7279
e-mail: www.bobsairdoc.com

PROTECT YOUR MODEL, YOURSELF & OTHERS...FOLLOW THESE IMPORTANT SAFETY PRECAUTIONS

1. Your Gee Bee should not be considered a toy, but rather a sophisticated, working model that functions very much like a full-size airplane. Because of its performance capabilities, the Gee Bee, if not assembled and operated correctly, could possibly cause injury to yourself or spectators and damage to property.

2. You must assemble the model **according to the instructions**. Do not alter or modify the model, as doing so may result in an unsafe or unflyable model. In a few cases the instructions may differ slightly from the photos. In those instances the written instructions should be considered as correct.

3. You must take time to **build straight, true and strong**.

4. You must use an R/C radio system that is in first-class condition and a correctly sized engine and components (fuel tank, wheels, etc.) throughout the building process.

5. You must correctly install all R/C and other components so that the model operates correctly on the ground and in the air.

6. You must check the operation of the model before **every** flight to insure that all equipment is operating and that the model has remained structurally sound. Be sure to check clevises or other connectors often and replace them if they show any signs of wear or fatigue.

7. If you are not already an experienced R/C pilot, you should fly the model only with the help of a competent, experienced R/C pilot.

8. While this kit has been flight tested to exceed normal use, if the plane will be used for extremely high stress flying, such as racing, the modeler is responsible for taking steps to reinforce the high stress points.

We, as the kit manufacturer, provide you with a top quality kit and instructions, but ultimately the quality and flyability of your finished model depends on how you build it; therefore, we cannot in any way guarantee the performance of your completed model and no representations are expressed or implied as to the performance or safety of your completed model.

Remember: Take your time and follow the instructions to end up with a well-built model that is straight and true.

If you have not flown this type of model before, we recommend that you get the assistance of an experienced pilot in your R/C club for your first flights. If you're not a member of a club, your local hobby shop has information about clubs in your area whose membership includes experienced pilots.

In addition to joining an R/C club, we strongly recommend you join the AMA (Academy of Model Aeronautics). AMA membership is required to fly at AMA sanctioned clubs. There are over 2,500 AMA chartered clubs across the country. Among other benefits, the AMA provides insurance to its members who fly at sanctioned sites and events. Additionally, training programs and instructors are available at AMA club sites to help you get started the right way. Contact the AMA at the address or toll-free phone number below:



Academy of Model Aeronautics
5151 East Memorial Drive
Muncie, IN 47302-9252
Tele. (800) 435-9262
Fax (765) 741-0057

Or via the Internet at: <http://www.modelaircraft.org>

DECISIONS YOU MUST MAKE

This is a partial list of items required to finish the Gee Bee that may require planning or decision making before starting to build.

Radio Equipment

4-Channel transmitter and a minimum 4-channel receiver. (A 6-channel computer radio transmitter and receiver may offer some mixing functions desirable for this model).

6 - servos, minimum 40 oz-in torque

2 - 12" [305mm] servo extensions

2 - Y-harness connectors

1 - servo reverser for the two elevator servos (only if you are not able to mix two channels to move two servos in the same direction with your computer radio.)

Engine Recommendations

The recommended engine size range for the Gee Bee is .91 to 1.08 two-stroke or 1.20 four-stroke. If an engine in the upper end of the size range is used, remember that this is a scale model that is intended to fly at scale-like speeds, so throttle management should be practiced.

ADDITIONAL ITEMS REQUIRED

Hardware and Accessories

In addition to the items listed in the "Decisions You Must Make" section, following is the list of hardware and accessories required to finish the Gee Bee. Order numbers are provided in parentheses.

- Engine and suitable propellers
- 4-channel radio with 6 servos, minimum 40 oz-in torque
- 2 - 12" [300mm] servo extension (HCAQ2711 for Futaba®)
- Y-harness (HCAQ2751 for Futaba)
- 1 - servo reverser for the two elevator servos (only if you are not able to mix two channels to move two servos in the same direction with your computer radio.)
- R/C foam rubber (1/4" [6mm] - HCAQ1000, or 1/2" [13mm] - HCAQ1050)
- 3' [900mm] standard silicone fuel tubing (GPMQ4131)
- Fuel filler valve for glow fuel (GPMQ4160)

Adhesives and Building Supplies

In addition to common household tools and hobby tools, this is the "short list" of the most important items required to build the Gee Bee. **Great Planes Pro™ CA and Epoxy glue are recommended.**

- 1 oz. [30g] Thin Pro CA (GPMR6002)
- 1 oz. [30g] Medium Pro CA+ (GPMR6008)
- Pro 30-minute epoxy (GPMR6047)
- Pro 6-minute epoxy (GPMR6045)
- R/C-56 canopy glue (JOZR5007)
- Microballoons (TOPR1090)
- Drill bits: 1/16" [1.6mm], 5/64" [2mm], 3/32" [2.4mm], 1/8" [3.2mm], 9/64" [3.6mm], 5/32" [4mm], 3/16" [4.8mm], 1/4" [6.4mm]
- Stick-on segmented lead weights (GPMQ4485)
- 1 Hobby knife (HCAR0105)
- #11 blades (5-pack, HCAR0211)
- File

Covering Tools

- Top Flite® MonoKote® sealing iron (TOPR2100)
- Top Flite Hot Sock™ iron cover (TOPR2175)
- Top Flite MonoKote trim seal iron (TOPR2200)
- Top Flite MonoKote heat gun (TOPR2000)

Optional Supplies and Tools

- 2 oz. [57g] spray CA activator (GPMR6035)
- CA applicator tips (HCAR3780)
- CA debonder (GPMR6039)
- Epoxy brushes (6, GPMR8060)
- Mixing sticks (50, GPMR8055)
- Mixing cups (GPMR8056)
- Curved-tip canopy scissors for trimming plastic parts (HCAR0667)
- Hobbico® Duster™, can of compressed air (HCAR5500)
- Masking tape (TOPR8018)
- Threadlocker thread locking cement (GPMR6060)
- Denatured alcohol (for epoxy clean up)
- Switch & Charge Jack Mounting Set (GPMM1000)
- Rotary tool such as a Dremel®
- Rotary tool reinforced cut-off wheel (GPMR8200)
- Servo horn drill (HCAR0698)
- Dead Center™ Engine Mount Hole Locator (GPMR8130)
- AccuThrow™ Deflection Gauge (GPMR2405)
- CG Machine™ (GPMR2400)
- Laser incidence meter (GPMR4020)
- Precision Magnetic Prop Balancer™ (TOPQ5700)

IMPORTANT BUILDING NOTES

- There are two types of screws used in this kit:

Sheet metal screws are designated by a number and a length. For example #6 x 3/4" [19mm]



This is a number six screw that is 3/4" [19mm] long.

Machine screws are designated by a number, threads per inch and a length. For example 4-40 x 3/4" [19mm]

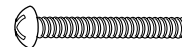

This is a number four screw that is 3/4" [19mm] long with forty threads per inch.

- When you see the term **test fit** in the instructions, it means that you should first position the part on the assembly **without using any glue**, then slightly modify or *custom fit* the part as necessary for the best fit.

- Whenever the term **glue** is written you should rely upon your experience to decide what type of glue to use. When a specific type of adhesive works best for that step, the instructions will make a recommendation.

- Whenever just **epoxy** is specified you may use **either** 30-minute (or 45-minute) epoxy **or** 6-minute epoxy. When 30-minute epoxy is specified it is **highly** recommended that you use only 30-minute (or 45-minute) epoxy, because you will need the working time and/or the additional strength.

- **Photos** and **sketches** are placed **before** the step they refer to. Frequently you can study photos in following steps to get another view of the same parts.

- The Gee Bee is factory-covered with Top Flite MonoKote film. Should repairs ever be required, MonoKote can be patched with additional MonoKote purchased separately. MonoKote is packaged in six-foot rolls, but some hobby shops also sell it by the foot. If only a small piece of MonoKote is needed for a minor patch, perhaps a fellow modeler would give you some. MonoKote is applied with a model airplane covering iron, but in an emergency a regular iron could be used. A roll of MonoKote includes full instructions for application. Following are the colors used on this model and order numbers for six foot rolls.

Red – TOPQ0201
White – TOPQ0204

- The stabilizer and wing incidences and engine thrust angles have been factory-built into this model. However, some technically-minded modelers may wish to check these measurements anyway. To view this information visit the web site at www.greatplanes.com and click on "Technical Data." Due to manufacturing tolerances which will have little or no effect on the way your model will fly, please expect slight deviations between your model and the published values.

IMPORTANT INFORMATION ABOUT WORKING WITH FIBERGLASS

If you have never worked with fiberglass there are a few basic things you should be aware of:

1. When you are cutting into fiberglass, be sure you are cutting the correct place. Unlike wood, you are not able to go back and easily fix a mistake.

2. Whenever you are gluing a part to the inside of fiberglass it is important to roughen the inside surface of the fiberglass with 220-grit sandpaper. Then wipe the area with alcohol. The molding process leaves a waxy residue that can prevent a good bond between the glue and the parts being glued.

3. If you do not have a high-speed motor tool such as a Dremel® tool, you should consider purchasing one or borrowing one from a fellow modeler. This combined with a fiberglass cut-off wheel is going to be extremely helpful in the assembly process.

WARNING: The cowl, wheel pants and fuselage included in this kit are made of fiberglass, the fibers of which may cause eye, skin and respiratory tract irritation. Never blow into a part to remove fiberglass dust, as the dust will blow back into your eyes. Always wear safety goggles, a particle mask and rubber gloves when grinding, drilling and sanding fiberglass parts. Vacuum the parts and the work area thoroughly after working with fiberglass parts.

ORDERING REPLACEMENT PARTS

To order replacement parts for the Great Planes Gee Bee ARF, use the order numbers in the **Replacement Parts List** that follows. Replacement parts are available only as listed. Not all parts are available separately (an aileron cannot be purchased separately, but is only available with the wing kit). Replacement parts are not available from Product Support, but can be purchased from hobby shops or mail order/Internet order firms. Hardware items (screws, nuts, bolts) are also available from these outlets. If you need assistance locating a dealer to purchase parts, visit www.greatplanes.com and click on "Where to Buy." If this kit is missing parts, contact **Product Support**.

Replacement Parts List

<u>Order Number</u>	<u>Description</u>	<u>How to Purchase</u>
	Missing pieces	Contact Product Support
	Instruction manual.....	Contact Product Support
	Full-size plans	Not available
	Kit parts listed below.....	Hobby Supplier
GPMA2390	Wing Kit	
GPMA2391	Fuselage Kit	
GPMA2392	Stabilizer Set	
GPMA2393	Rudder	
GPMA2394	Landing Gear Set	
GPMA2395	Wheel Pants	
GPMA2396	Canopy	
GPMA2397	Cowl	
GPMA2398	Decal Set	

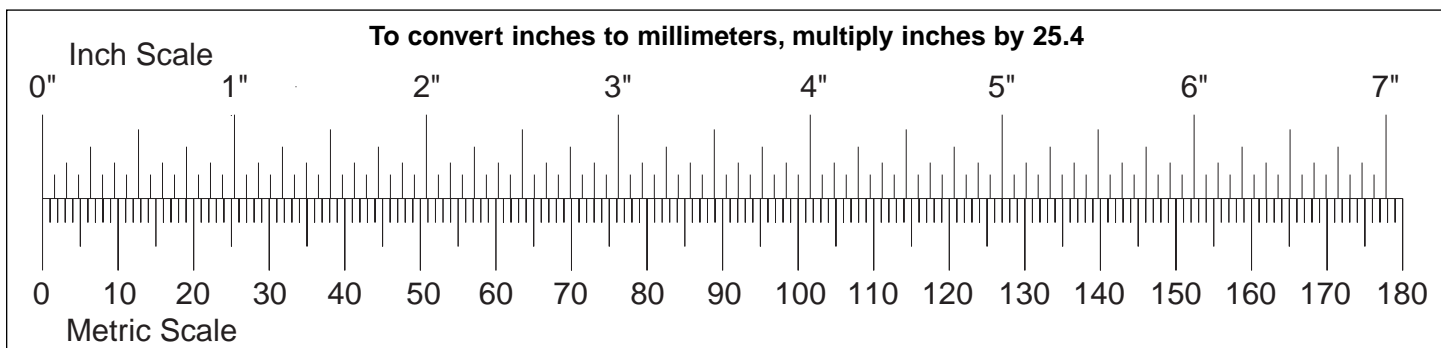

KIT INSPECTION

Before starting to build, take an inventory of this kit to make sure it is complete and inspect the parts to make sure they are of acceptable quality. If any parts are missing or are not of acceptable quality, or if you need assistance with assembly, contact **Product Support**. When reporting defective or missing parts, use the part names exactly as they are written in the Kit Contents list on this page.

Great Planes Product Support
3002 N. Apollo Drive, Suite 1
Champaign, IL 61822
Telephone: (217) 398-8970
Fax: (217) 398-7721
E-mail: airsupport@greatplanes.com

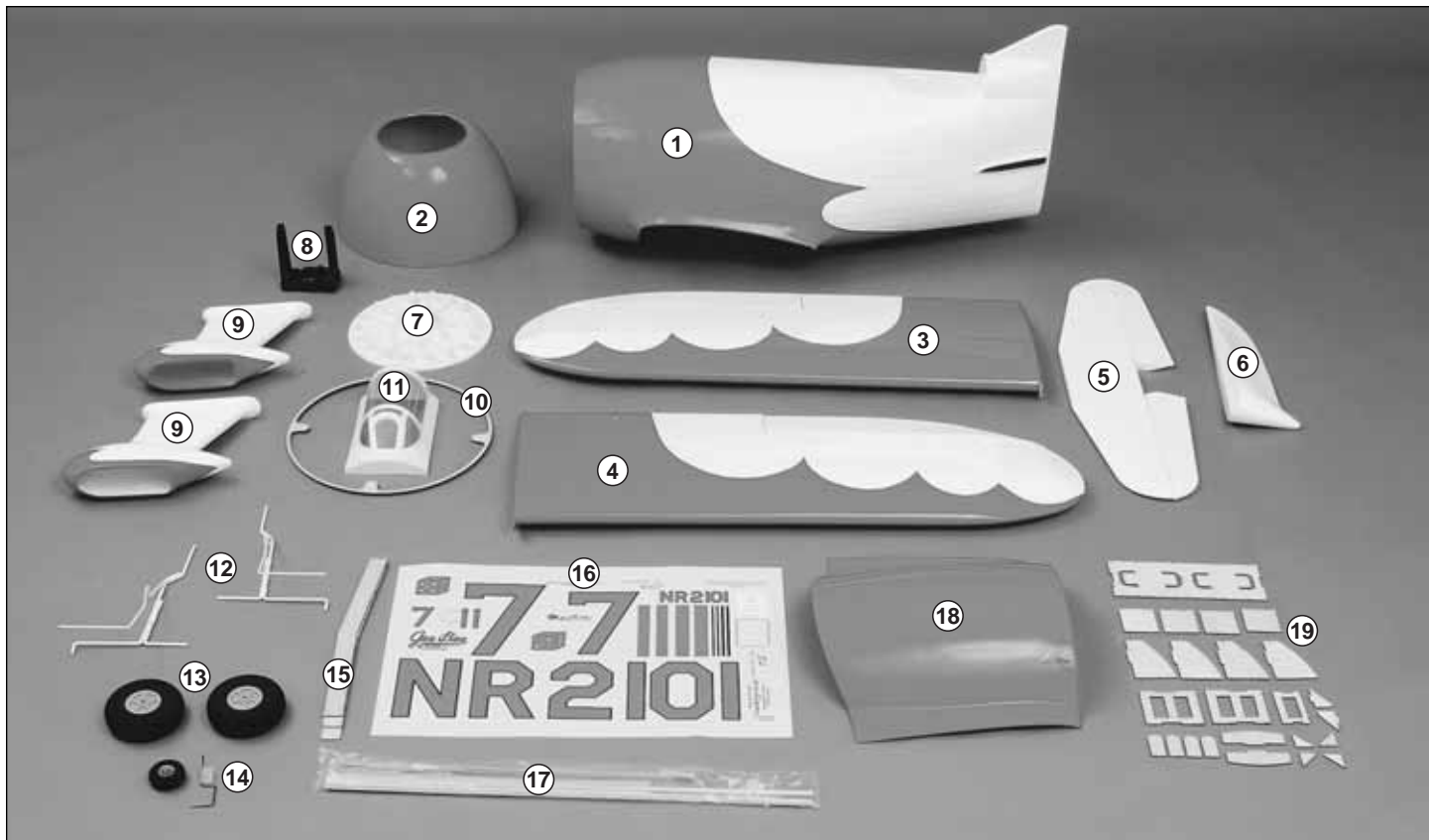

Kit Contents (Photographed)

- | | | |
|---|--|--|
| <ul style="list-style-type: none"> 1 Fuselage 2 Cowl 3 Right Wing and Aileron 4 Left Wing and Aileron 5 Stabilizer and Elevators 6 Rudder 7 Dummy Engine | <ul style="list-style-type: none"> 8 Engine Mount 9 Wheel Pants 10 Cowl Ring (2) 11 Canopy 12 Wire Landing Gear 13 Main Wheels 14 Tail Wheel Assembly | <ul style="list-style-type: none"> 15 Wing Joiners 16 Decal Sheet (2) 17 Pushrods 18 Belly Pan 19 Plywood Servo Trays, Battery/Receiver Tray, and Cowl Mounting Parts |
|---|--|--|

Kit Contents (Not Photographed)

- | | | |
|--|---|--|
| <ul style="list-style-type: none"> (1) .60 -1.20 Engine mount (left) (1) .60 -1.20 Engine mount (right) (1) Brass EZ Connect (4) 6-32 Blind Nuts (4) 8-32 Blind Nuts (2) 1/4-20 Blind Nuts (1) Nylon Control Horn, Large (1) Nylon Bearing for tail wheel wire (2) 1/4 -20 Nylon bolts (5) Nylon Clevis (2) Flat Nylon landing Gear Straps (1tree of 4) (1) Nylon retainer | <ul style="list-style-type: none"> (1) 2x9 Hinge material (6) Faslink (5) Silicone Clevis Keeper (4) 6-32 Set Screw (2) 6-32 x 1/4" SHCS (2) 4-40 Set Screw (1) 4-40 x 1/4" SHCS (4) 6-32 x 1/2" SHCS (8) #4 x 5/8 SMS (8) 8-32 x 1" SHCS (34) #2 x 1/2" SMS (3) Heat Shrink Tube | <ul style="list-style-type: none"> (2) 1/8 Wheel Collar (4) 5/32 Wheel Collar (3) .074 x 17 1/2" wire (3) .074 x 6" wire (4) #6 Flat Washer (8) #8 Lock washer (8) #8 Flat Washer (2) Axles (4) 3 x 51 x 51mm Plywood Plate (4) 3mm Plywood Cowl Mount Tabs (18) 1/8" x 3/4" Aluminum Tube (1) Pilot |
|--|---|--|

PREPARATIONS

1. If you have not done so already, remove the major parts of the kit from the box and inspect for damage. If any parts are damaged or missing, contact Product Support at the address or telephone number listed in the "Kit Inspection" section on page 6.



2. Remove the tape and separate the ailerons and flaps from the wing and the elevators from the stab. Use a covering iron with a covering sock on high heat to tighten the covering if necessary. Apply pressure over sheeted areas to **thoroughly** bond the covering to the wood.

ASSEMBLE THE FUSELAGE STAND

Because of the awkward shape of the Gee Bee we have designed a very useful foam cradle for the model. As you have already seen it was used in the shipping box, can be used as an assembly stand and for transporting the Gee Bee to the flying field!

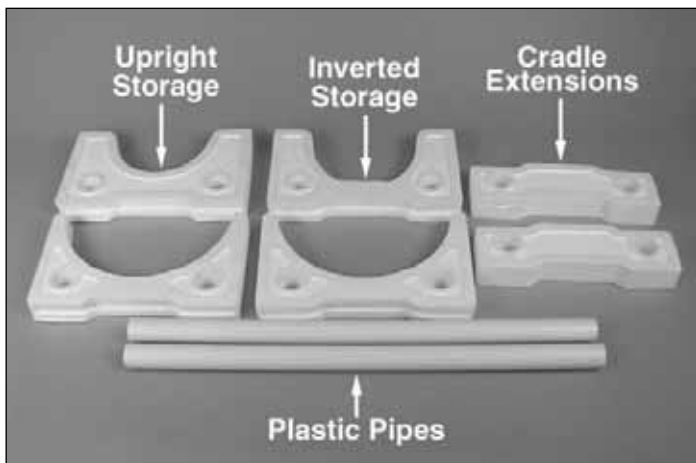

1. Locate the components of the foam cradle.

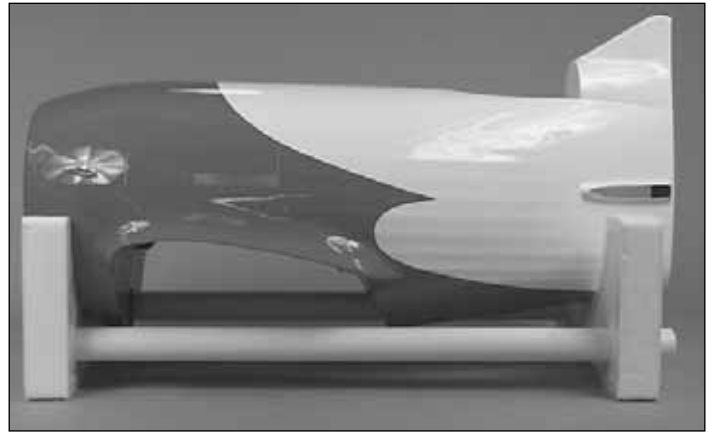

2. Slide the foam part with the large oval onto one end of each of the two plastic pipes. Slide the part with the small oval on the opposite end. This configuration will hold the Gee Bee upright on your workbench and work well for transporting your Gee Bee too!

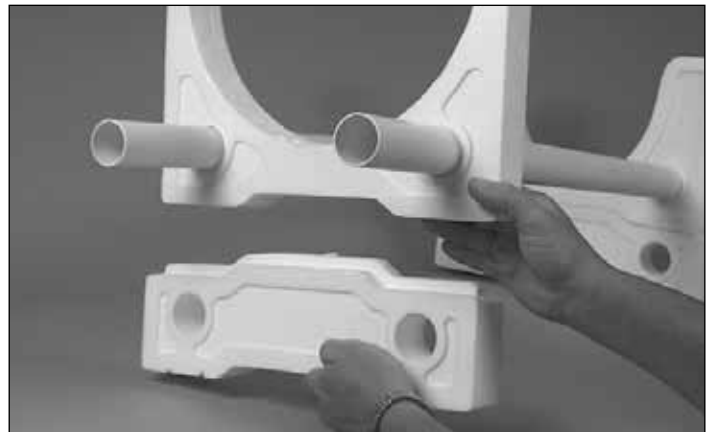

3. For working on the Gee Bee inverted on the bench, remove the foam parts from the pipes and replace them with the other two large foam parts. Insert the small cradle extensions onto the bottom of the foam parts. This will provide the additional height required to provide clearance for the vertical fin. The cradle extensions fit snugly into the foam cradle but may loosen with use. You may wish to consider gluing them together with epoxy for a more permanent installation.

Note: *At the time this manual was written we had not yet received the foam cradle that is included with this kit so we used a different stand for our construction photographs.*

BUILD THE WING

Install the Ailerons

Do the right wing first so your work matches the photos the first time through. You can do one wing at a time, or work on them together.

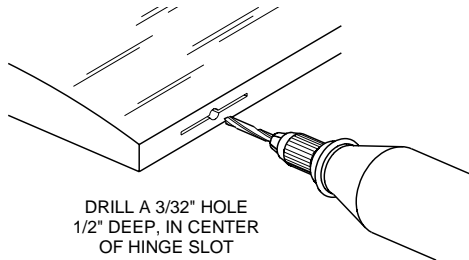

1. Drill a 3/32" hole, 1/2" deep in the center of each hinge slot to allow the CA to "wick" in. Follow-up with a #11 blade to clean out the slots. **Hint:** If you have one, use a high-speed rotary tool to drill the holes.

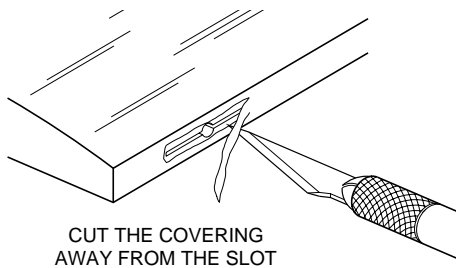

2. Use a sharp #11 blade to cut a strip of covering from the hinge slots in the wing and aileron.

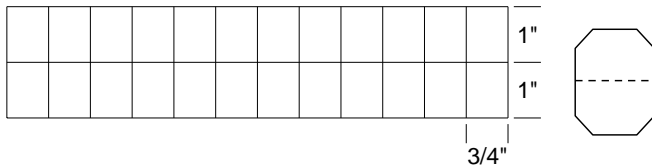

3. Cut three 3/4" x 1" hinges from the CA hinge strip. Snip off the corners so they go in easier.

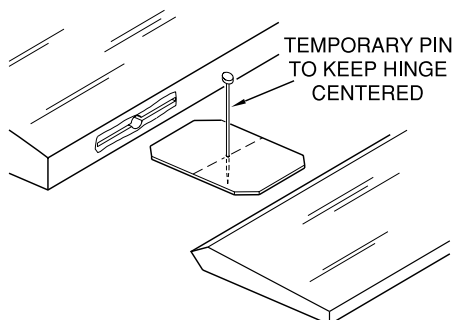

4. Test fit the ailerons to the wing with the hinges. If the hinges don't remain centered, stick a pin through the middle of the hinge to hold it in position.

5. Remove any pins you may have inserted into the hinges. Adjust the aileron so there is a small gap between the LE of the aileron and the wing. The gap should be small, just enough to see light through or to slip a piece of paper through.



6. Apply six drops of thin CA to the top and bottom of each hinge. Do not use CA accelerator. After the CA has fully hardened, test the hinges by pulling on the aileron.

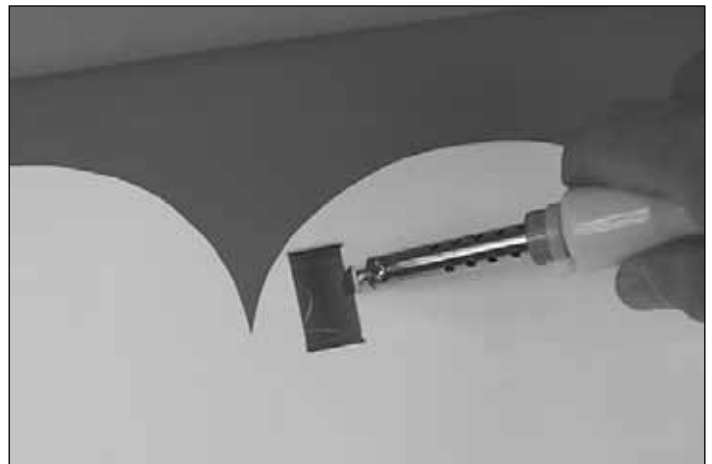

7. Cut the covering 1/8" [3mm] inside the opening in the wing for the aileron servo. Use a trim iron to seal the covering to the inner edges of the opening.

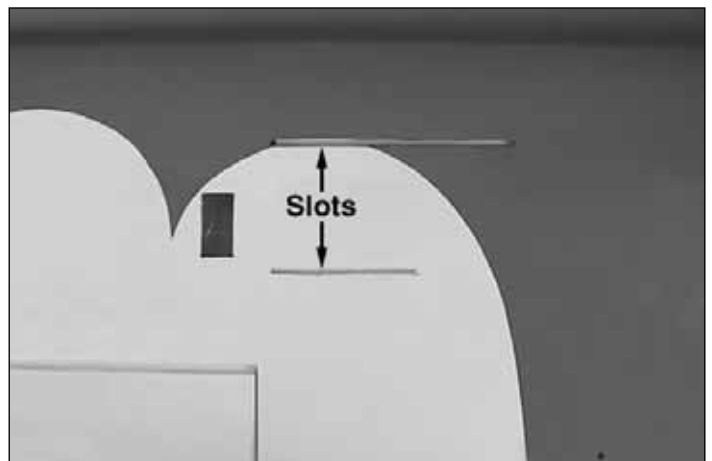

8. On the bottom of the wing, cut the covering from the two slots for the landing gear.

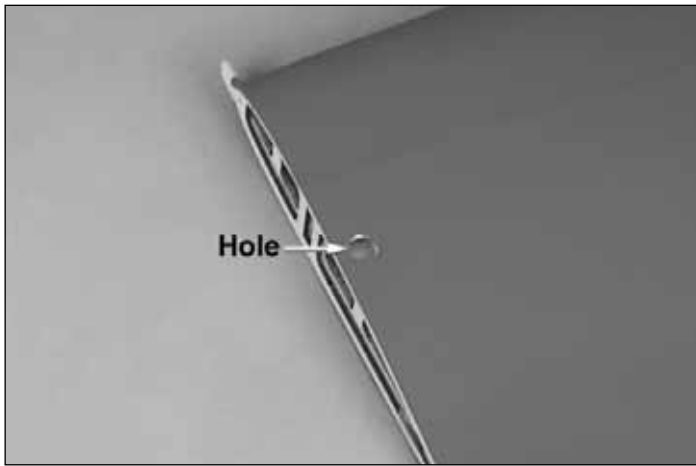

□ □ 9. On the top of the wing, cut the covering away from the hole at the wing center section. This hole is for the aileron servo wire to come through, into the fuselage.

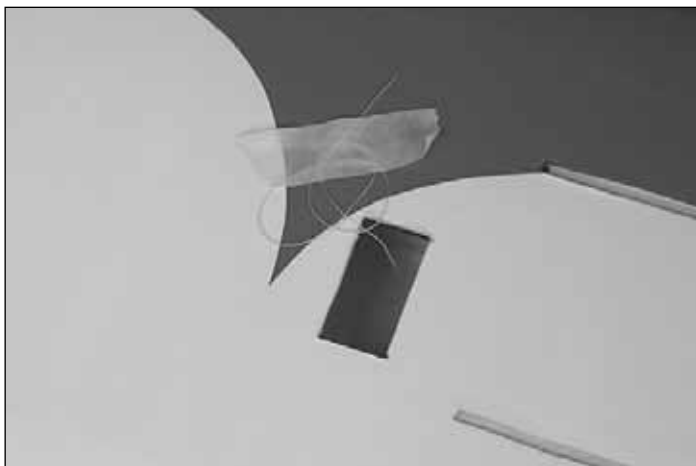

□ □ 10. Remove the string from inside of the aileron servo bay and tape it to the wing. **Do not pull the string out of the wing!**

□ 11. Repeat steps 1-10 for the left wing panel.

Install the Aileron Servos and Pushrods

□ □ 1. Installing the servos in the wing will require the use of one 12" [305mm] servo extension for each aileron. One Y-harness connector is required and is used to allow the aileron servos to plug into one slot in your receiver. You may have a computer radio that allows you to plug the servos into separate slots and then mix them together through the radio transmitter. If you choose to mix them with the radio rather than the Y-harness, refer to the instructions with your particular brand of radio.

□ □ 2. Attach the servo extension to the aileron servo. Secure the connectors together using a large piece of heat shrink tubing, tape or other method for securing the connectors together.



□ □ 3. Tie the string from inside the wing to the end of the servo wire. Pull the servo wire through the wing with the string. Feed the servo wire out the hole in the top of the wing center section. Tape the servo wire to the wing to prevent it from falling back into the wing.



□ □ 4. Temporarily position the aileron servo into the servo bay. Drill a 1/16" [1.6mm] hole through the four mounting holes of the servo, drilling through the plywood mounting plate in the wing. Install and remove a servo mounting screw into each of the four holes. Insert a drop of thin CA into the holes to harden the wood. After the glue has cured, install the servo into the servo bay using the hardware that came with your servo. Center the servo and install a servo arm as shown.

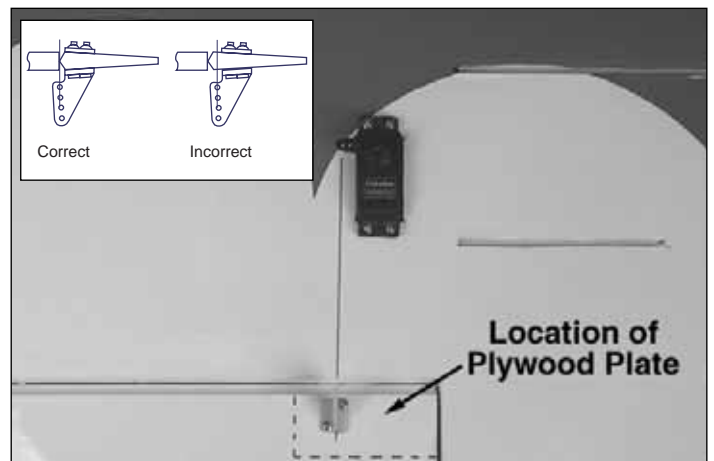

□ □ 5. Position a large nylon **control horn** on the aileron, positioning it as shown in the sketch and aligning it with the

servo. Mark the location for the screw holes. Drill through the marks you made with a 1/16" [1.6mm] drill bit. (Be sure you are drilling into the plywood plate mounted in the bottom of the aileron. Drill through the plate only. **Do not drill all the way through the aileron!**) Using a #2 x 1/2" [#2 x 13mm] sheet metal screw, install and then remove a screw into each of the holes. Harden the holes with thin CA. Install the control horn with four #2 x 1/2" [#2 x 13mm] sheet metal screws.

❑ 6. Locate a .074" x 6" [.074" x 152mm] **pushrod wire** threaded on one end. Screw a nylon clevis onto the threaded end of the wire 20 turns. Install a silicone clevis keeper onto the clevis. Then, install the clevis on the aileron control horn.

❑ 7. Be sure the aileron servo is centered. Enlarge the first hole in the servo arm with a Hobbico Servo Horn Drill (or a #48 or 5/64" [2mm] drill bit). Center the aileron and align the wire pushrod with the hole in the end of the servo arm. Using a marker, mark the location where the wire aligns with the hole in the servo arm. On that mark make a 90 degree bend. From the bend measure an additional 3/16" [4.8mm] and then cut off the excess pushrod wire.

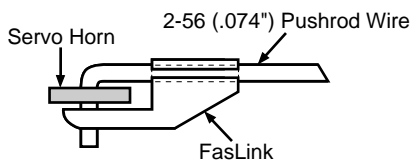
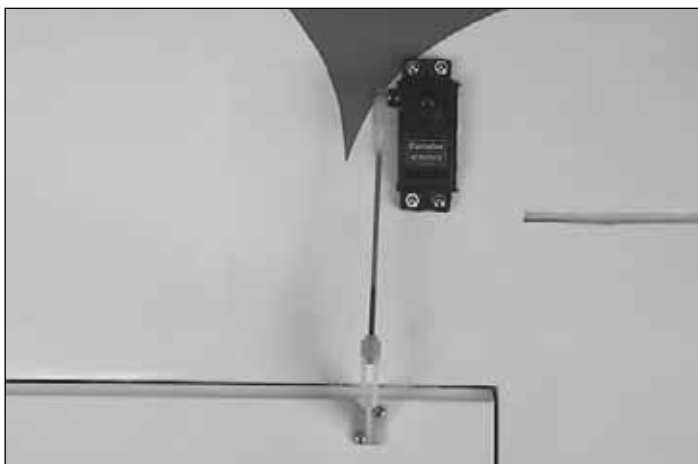

❑ 8. Install the wire into the hole in the servo arm using a nylon **FasLink™** as shown in the sketch.

❑ 9. Repeat steps 1-8 for the left wing panel.

Join the Wings

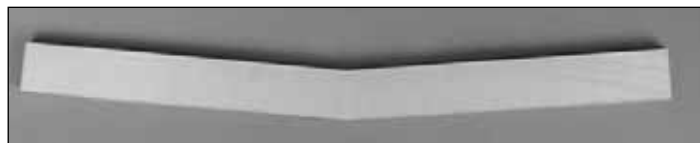
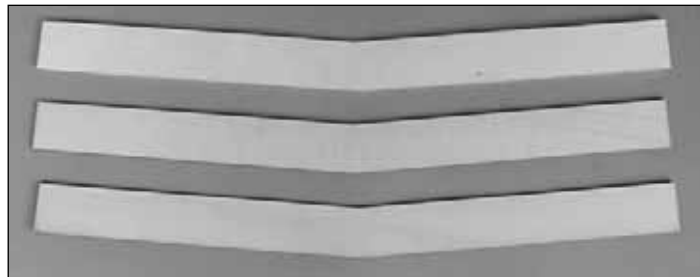

❑ 1. Locate the three hardwood **wing joiners**. Using 5-minute epoxy, glue them together forming one 1/4" [6mm] wing joiner.

❑ 2. Test fit the wing joiner into each wing panel, making sure that it is not too tight. Sand the joiner as needed to get a good fit.

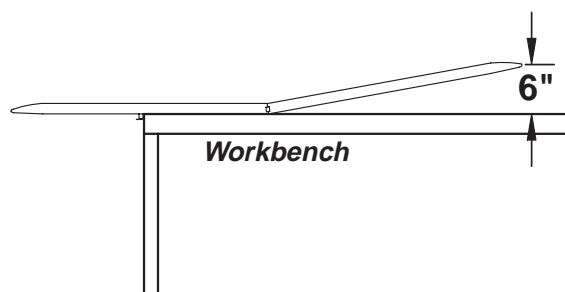
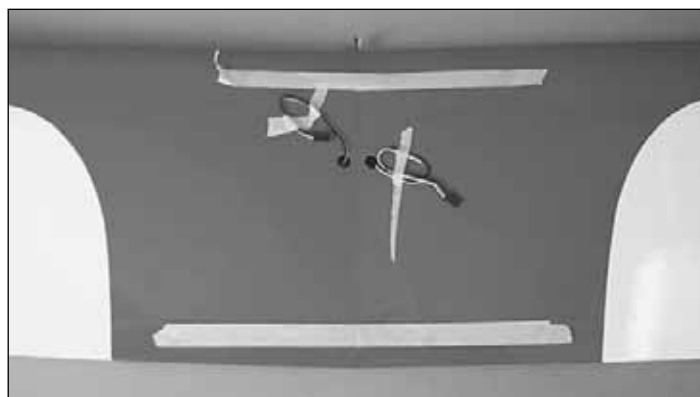

❑ 3. Apply 30-minute epoxy to both sides of the wing joiner, the joiner pocket in both wing panels and to the root rib of each wing panel. Push the wing panels together and hold them in place with masking tape. Before the glue cures, set the wing flat on your bench and measure the dihedral. The distance from the top of the bench to the center of the wing as measured at the wingtip should be approximately 6" [152mm]. Block the wingtip up while the glue cures. **Note:** Due to production techniques there may be some variance in the actual dihedral of each model. Our prototypes flew well with the dihedral anywhere between 5-3/4" and 6-1/4" [146mm and 159mm].

❑ 4. Set the wing aside allowing the glue to cure.

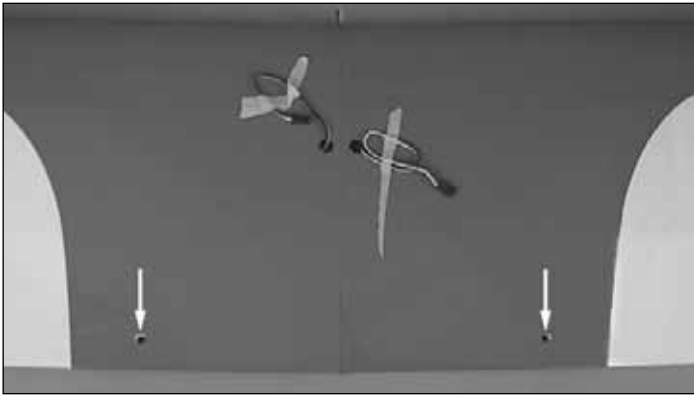

❑ 5. Locate the 1/4" [6mm] holes under the covering at the trailing edge of the wing center section. Cut the covering away on both the top and bottom of the wing.

❑ 6. Trial fit the wing to the fuselage with two 1/4 - 20 nylon wing bolts. After fitting the wing, remove it from the fuselage.

Install the Landing Gear



❑ ❑ 1. Locate the wire landing gear. Insert the right gear into the slots in the bottom of the wing. When properly inserted the landing gear has a forward rack.

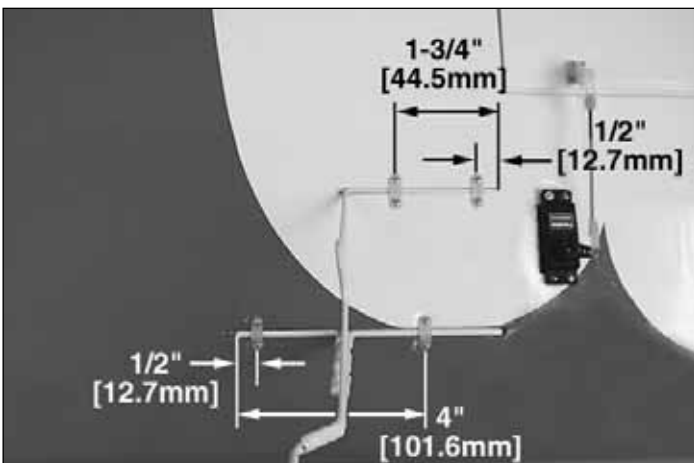

❑ ❑ 2. Position four nylon landing gear straps over the landing gear wire. Using the measurements shown in the

photo, mark the location for the screw holes. **Note:** It is important that the straps are located as shown or they could interfere with the installation of the wheel pants. Drill a 1/16" [1.6mm] hole through the marks, drilling through the hardwood rail under the covering. Insert a #2 x 1/2" [13mm] screw into each of the holes you have drilled and then remove it. Put a couple of drops of thin CA into the holes to harden the wood and allow the glue to cure. Install each of the landing gear straps over the landing gear wire with #2 x 1/2" [13mm] sheet metal screws.

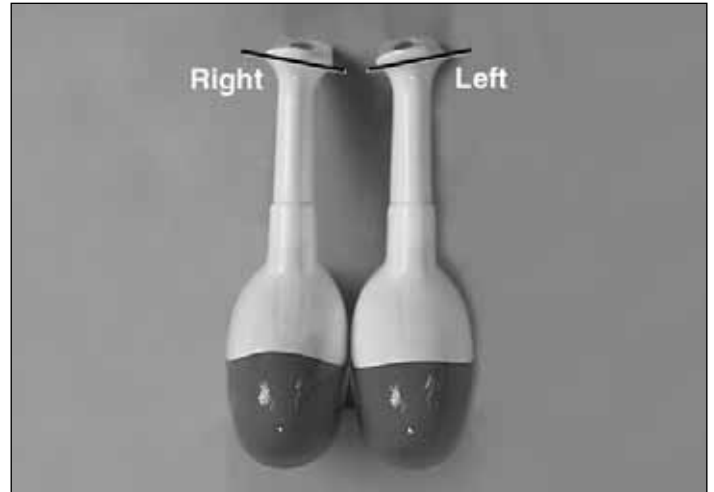

❑ ❑ 3. Locate the right side wheel pant. **Note:** If you examine the base of the two wheel pants you will see that there is a definite difference in the angle of the base of the wheel pant. This is to accommodate the dihedral in the wing. Be sure you mount the correct pant to each side of the wing.

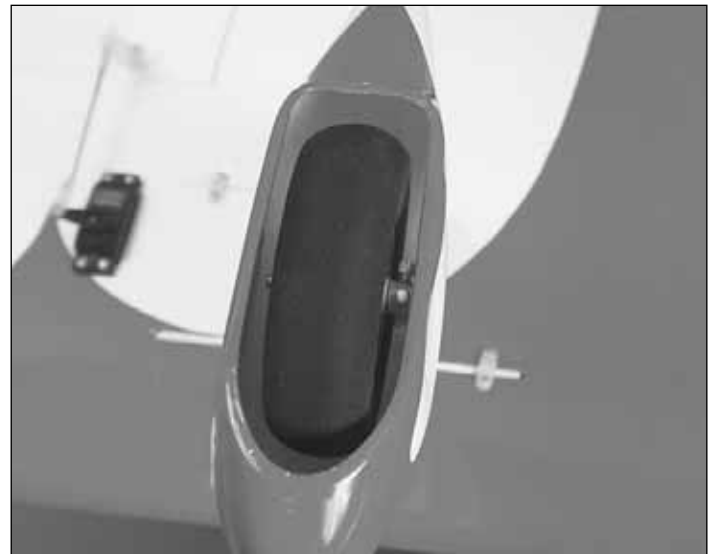

❑ ❑ 4. Slide the wheel pant over the landing gear wire. Locate the axle, a 6-32 x 1/2" socket head cap screw and a wheel. Insert the 6-32 socket head cap screw into the axle. Slide the wheel over the axle. Temporarily tighten the axle to the landing gear wire. Having the wheel in position will assist you in locating the proper position for the wheel pant.



□ □ 5. Position the wheel pant so that the wheel is centered in the opening. Mark four locations for the wheel pant mounting screws onto the base of the wheel pant, two on each side of the pant. The mounting hole locations ***MUST*** be over the hardwood rails that the landing gear straps are screwed into. Once you are satisfied with the locations you have marked, remove the wheel and the wheel pant from the landing gear wire.

□ □ 6. Drill a 1/8" [3mm] hole through the wheel pant on each of the four marks you have made.



□ □ 7. Place the wheel and the wheel pant back onto the landing gear wire. Position the wheel pant on the wing. Using the holes in the wheel pant as your guide, drill a 5/64" [2mm] hole through the hardwood rails in the wing. Remove the wheel and wheel pant. Insert and then remove a #4 x 5/8" [15.9mm] sheet metal screw into each of the four holes you have drilled in the wing. Put a couple of drops of thin CA into the holes and allow the glue to cure. Once the glue has cured install the wheel pant to the wing with four #4 x 3/8" [9.5mm] sheet metal screws.

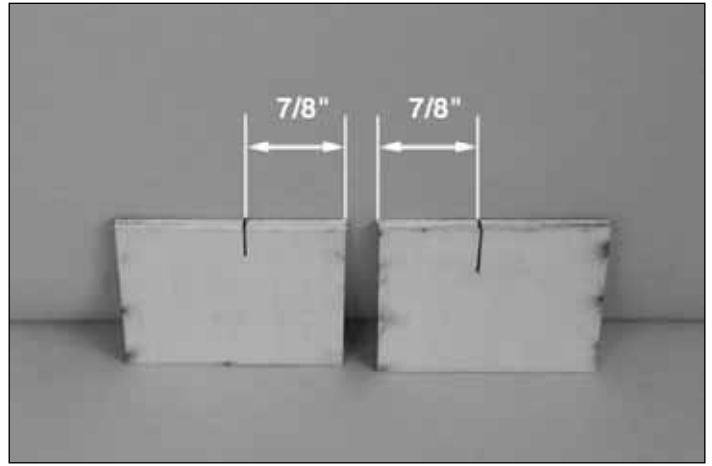

□ □ 8. Locate two 1/8" x 3/8" x 3/8" [3mm x 51mm x 51mm] **plywood plates**. From one edge of the plate measure in 7/8" [22.2mm] and mark a line onto the top edge and face of each plate.

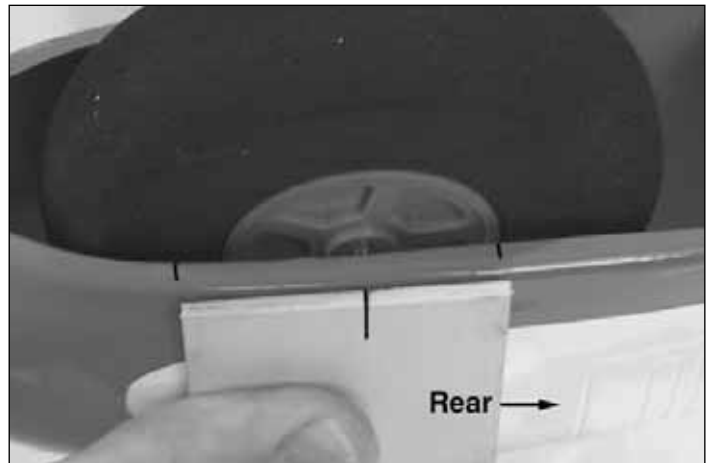

□ □ 9. Place the wheel and axle onto the landing gear wire. Position the plate so that the mark you have made on the plate is in line with the axle. (The 7/8" [22.2mm] portion of the plate should be to the rear of the wheel pant). Place two reference marks on the edge of the wheel pant to help align the plate in the following step. Do this for both plates and both sides of each wheel pant.



□ □ 10. Using 220-grit sandpaper, sand the inside of the wheel pant in the area the plates will be glued to. After

sanding, clean the area with rubbing alcohol. Mix 1/4 ounce [2 drams] of 6-minute epoxy and some microballoon filler. Add enough filler to make it difficult for the epoxy to run. Glue the plates inside each of the wheel pants, referencing the marks you made. You can hold the plates in place with small clamps. You might find it easier to glue the plates in one at a time rather than trying to do them together.

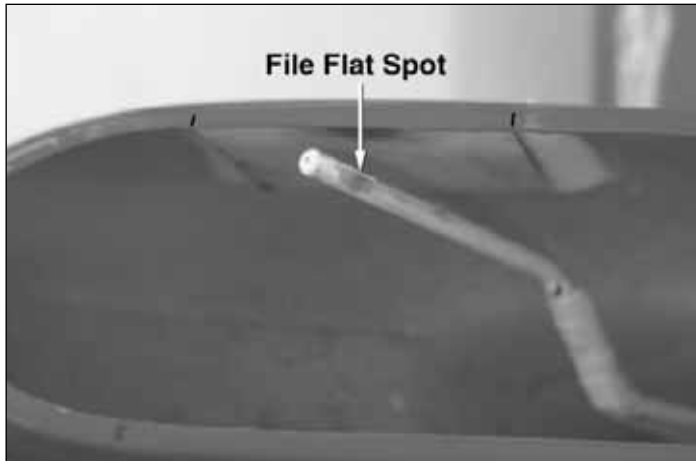

11. Install the wheel and axle onto the landing gear wire. Tighten the axle set screw. This should leave a small mark in the paint. Remove the wheel and axle. File a flat spot on the mark so that the axle will not rotate on the landing gear wire.

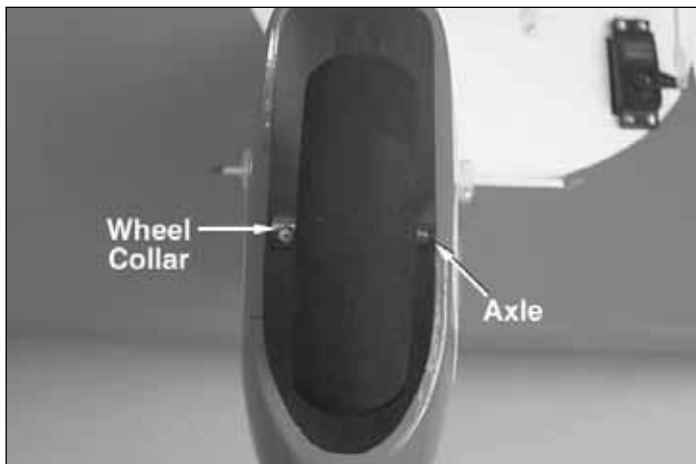

12. Permanently install the axle and wheel to the landing gear wire. File a flat spot on the wire where the 5/32" [4mm] wheel collar will be located. Install a 5-32" [4mm] wheel collar onto the axle to lock the wheel to the axle.

13. Repeat steps 1-12 for the other landing gear and wheel pant.

Install the Belly Pan

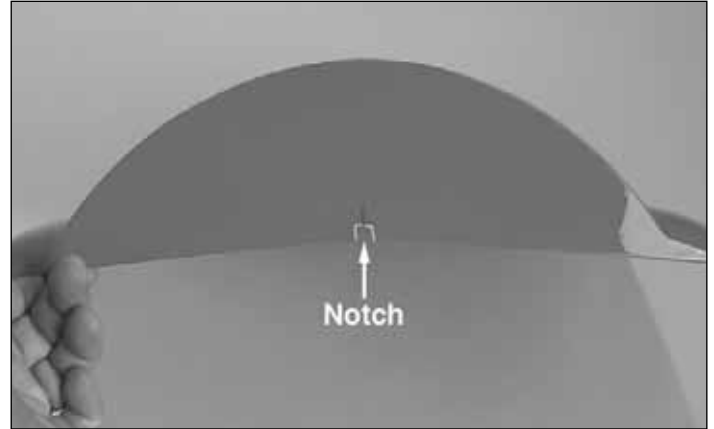

1. Locate the fiberglass belly pan. Mark the center of the belly pan on the face of the belly pan. Cut a notch 5/16" x 5/16" [7.9mm x 7.9mm] on the centerline. This will provide clearance for the belly pan to fit over the leading edge of the wing. Trim the sides of the belly pan on the "cut" lines.



2. Install the wing onto the fuselage. Place the belly pan in position on the wing. Transfer the location for the wing bolts to the belly pan. Cut 1/2" [13mm] clearance holes in the belly pan for the head of the wing bolts.



3. Place the belly pan back onto the fuselage. Using a fine line marker, draw the outline of the belly pan flanges onto the bottom of the wing.

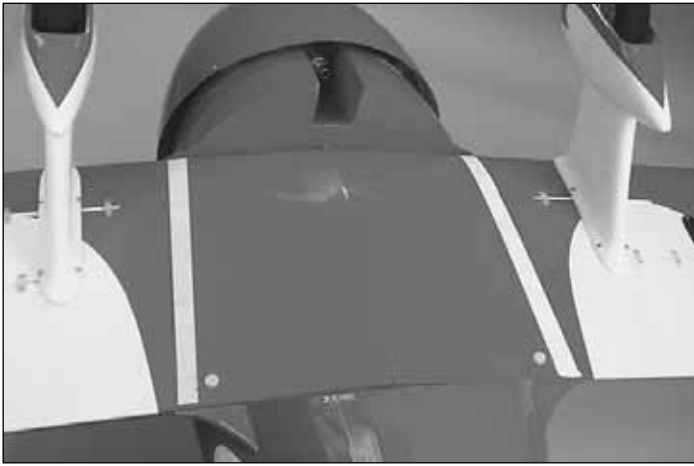

❑ 4. 1/16" [1.6mm] inside the lines you have drawn cut a 3/4" [19mm] wide strip of covering from the wing. Use a sharp #11 hobby knife or use the **Expert Tip** that follows to cut the covering from the wing along the lines you marked. Use care to cut **only into the covering** and **not** into the wood.

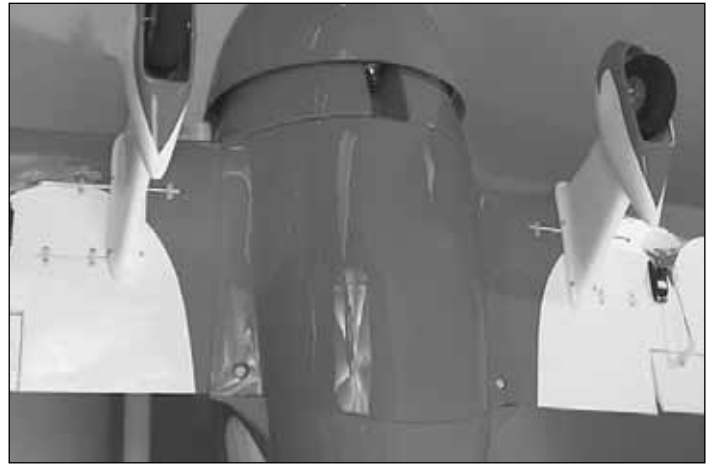

❑ 5. Where the belly pan contacts the wing, sand the inside of the belly pan with 220-grit sandpaper and then wipe the residue clean with rubbing alcohol. After the alcohol has dried, glue the belly pan to the wing with 6-minute epoxy. You will find it easier to glue one side at a time rather than trying to do both sides together.

ASSEMBLE THE FUSELAGE

Install the Engine and Throttle Servo

You now need to make a few decisions about the engine installation. Provided on page 35 in this instruction manual are two different engine mounting templates. One is for the O.S. 1.20 four-stroke engine and the other is for the O.S. .91 two-stroke engine. If you are using another brand of engine or engine mount you will have to do some measuring and use the reference marks in the fuselage to center the mount for your engine. The large opening in the bottom of the fuselage is to provide an easy exit for most standard mufflers. The engine mounting templates position the engines to allow the muffler on the O.S. 1.20 or the O.S. .91 to exit through this opening.

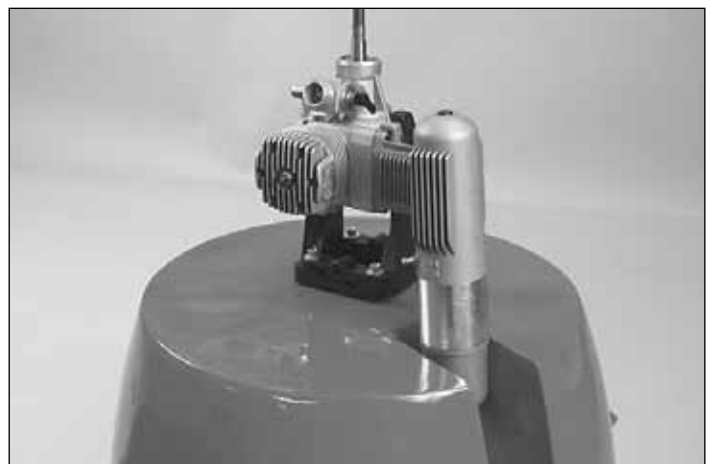

If you are using the O.S. .91 two-stroke engine you will need to use a muffler extension (OSMG2582) to help clear the bottom of the fuselage.

EXPERT TIP

How to cut covering from balsa.



Use a soldering iron to cut the covering from the stab. The tip of the soldering iron doesn't have to be sharp, but a fine tip does work best. Allow the iron to heat fully. Use a straightedge to guide the soldering iron at a rate that will just melt the covering and not burn into the wood. The hotter the soldering iron, the faster it must travel to melt a fine cut. Peel off the covering (see the photo at step 4).



Even with the extension it will be necessary to make a small clearance opening in the bottom of the fuselage to allow clearance between the muffler and the fuselage. Depending on the brand of engine used, you may have to change the position of this clearance hole. Again, depending on the engine you use you may or may not have to cut the cowl for a standard muffler to clear. You may want to consider using a "Pitts" style muffler.

As you can see there are some variables that you will have to work with depending on the engine you choose. The O.S. 1.20 four-stroke is our engine of choice because of how neatly it fits inside of the cowl. Before proceeding with installing the engine mount and engine, be sure you spend some time looking closely at how your engine will fit into the cowl and how well the muffler exits the fuselage.



- ❑ 1. Locate the left and right halves of the **engine mount**. Remove the molded spreaders, leaving the engine mount to look like the photograph. Be sure the two halves fit together smoothly.

The next few steps are going to cover installing the engine onto the motor mount. You may have assembled other kits where you installed the mount to the fuselage first. By mounting the engine to the mount first you can easily position the engine and muffler on the firewall as needed.

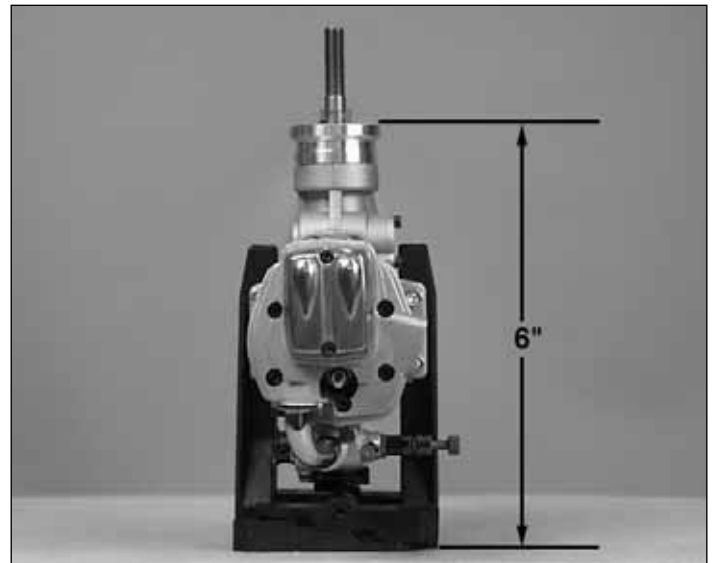

- ❑ 2. Position your engine onto the engine mount. Position the engine on the mount so that the distance from the back of the engine mount to the front of the engine thrust washer is 6" [152mm].

- ❑ 3. Using the engine as a guide, locate the four holes for the engine bolts. This is easily accomplished with a Great Planes Dead Center Tool (GPMR8130). Drill four #29 or 9/64" [3.6mm] holes in the mount. Then, use an 8-32 tap to thread the holes.

- ❑ 4. Use four 8-32 x 1" [8-32 x 25mm] socket head cap screws, four #8 lock washers, four #8 flat washers and Thread-Lock to install the engine onto the mount.

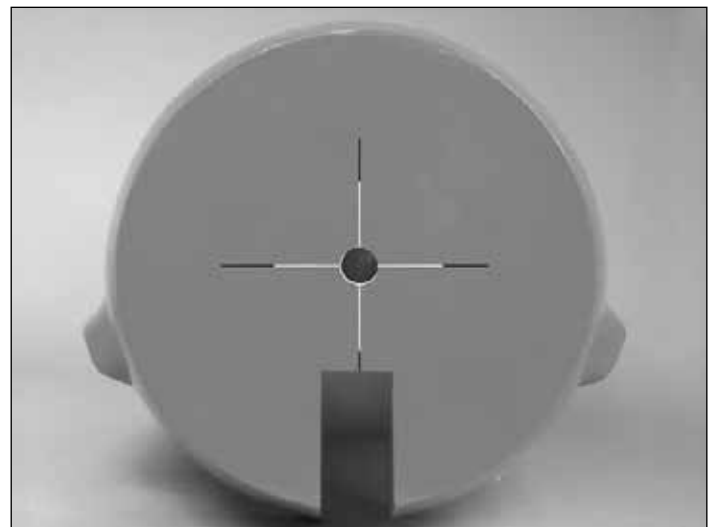

- ❑ 5. Locate the fiberglass **fuselage**. On the firewall you will find reference marks for the engine mount. Using a felt tip pen, draw over the reference marks and extend them further out onto the fuselage. This will assist you in mounting the engine.

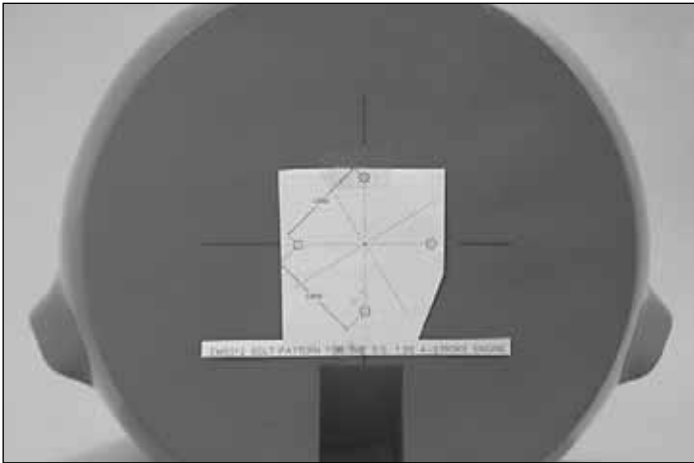
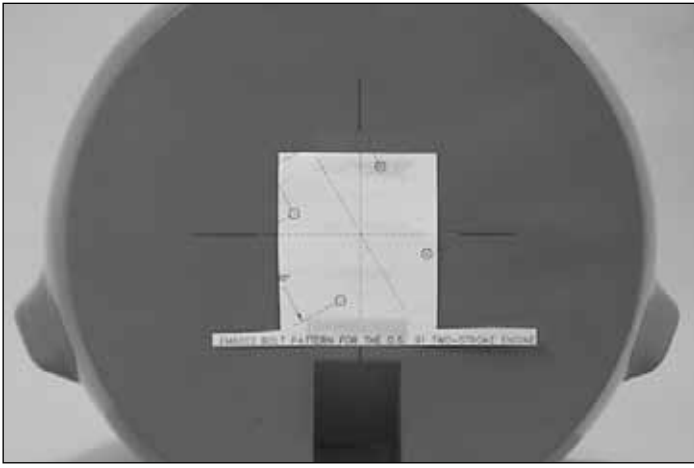

❑ 6. Tape the proper engine mount template to the firewall, aligning the template on the lines you have drawn on the firewall. Drill a 3/32" [2.4mm] pilot hole through each of the marks in the corners of the template. Enlarge each of the holes by drilling through the pilot holes with a 3/16" [4.8mm] drill bit.

❑ 7. Remove the template and install four 8-32 blind nuts on the backside of the firewall. This is easily done if you insert an 8-32 bolt into a #8 washer. Insert the bolt and washer through the hole. Reach into the fuselage with the blind nut, screwing it to the bolt. Tighten the bolt against the firewall, pulling the blind nut into place.

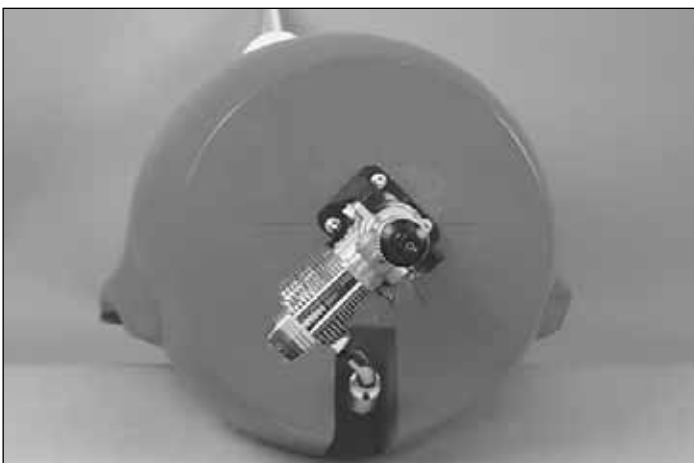

❑ 8. Mount the engine mount and engine to the fuselage with four 8-32 x 1" [8-32 x 25mm] socket head cap screws,

four #8 lock washers, four #8 flat washers and Thread-Lock. (Depending on your engine, you may have to remove the engine from the engine mount before installing the mount to the firewall. If this is the case with your engine, re-install the engine to the mount after the mount is attached to the fuselage). Leave the bolts slightly loose. Center the engine on the firewall and then tighten the bolts.

Note: The next 7 steps show how to install the throttle servo for the O.S. 1.20 four-stroke and the O.S. .91 two-stroke. As mentioned earlier you may have to modify these steps for your particular engine. On some of our prototypes we installed the throttle servo inside the fuselage using the tray that is provided. Take a minute to read through these steps before proceeding with the installation of your throttle servo.

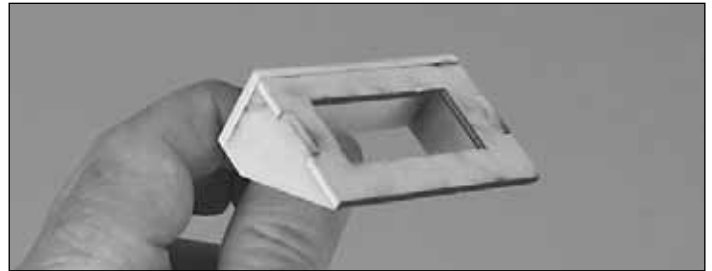
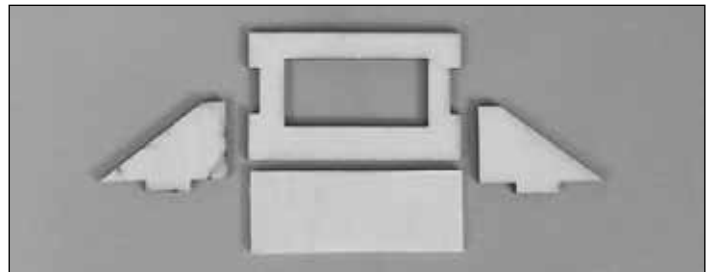

❑ 9. Locate the die-cut 3mm plywood parts for constructing the **throttle servo tray**. Glue them together as shown.

❑ 10. Drill four 1/16" [1.6mm] mounting holes in the servo tray for the throttle servo. Thread a mounting screw (included with the servo) into each hole and then remove the screw. Apply thin CA to the holes to harden the wood. After the glue has cured, install the servo into the tray using the hardware that came with the servos.

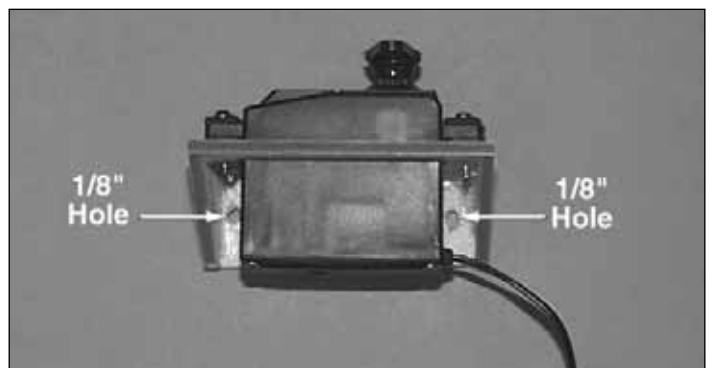

❑ 11. Drill a 1/8" [2.8mm] hole into the servo tray on each side of the servo.

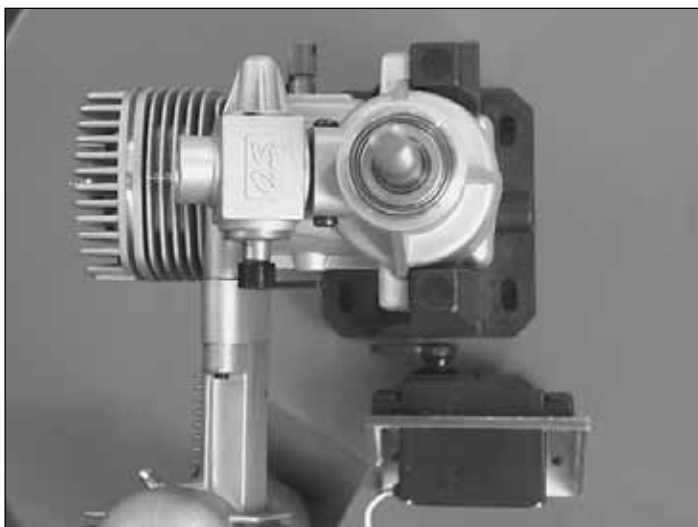

❑ 12. Position the servo tray with the arm on the servo so that it is in line with the carburetor arm.

❑ 13. On the firewall mark the location of the two holes you drilled in the servo tray. Drill through the marks on the firewall with a 1/8" [2.8mm] drill bit.

❑ 14. Install 4-40 blind nuts inside of the fuselage into the two holes you drilled. (**Note:** Because there are lightening holes in the firewall former it is possible that you may only drill through the fiberglass and not the plywood. If this is the case, drill a 1/8" [2.8mm] hole through scrap plywood and insert the blind nut into it. Then, place the plywood in position on the firewall. **DO NOT** try to pull a blind nut through the fiberglass.) Mount the servo tray to the firewall with two 4-40 x 1/2" [4-40 x 13mm] socket head cap screws and #4 washers.

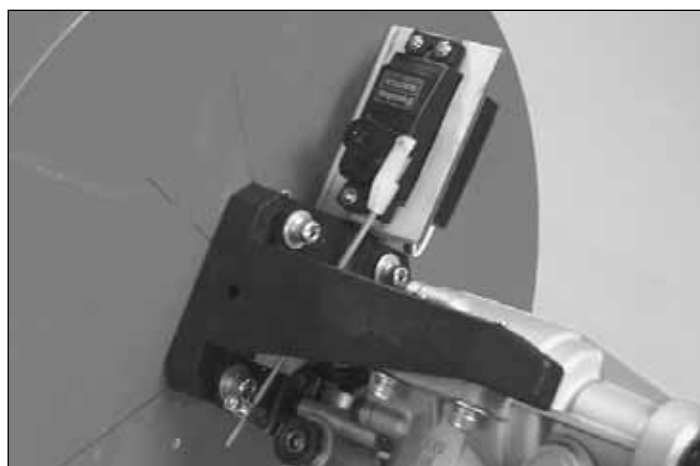
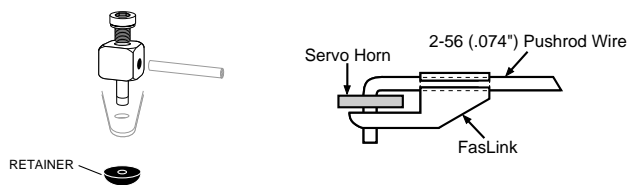

❑ 15. Cut off the threaded portion of a 6" [13mm] wire pushrod. Make a 90 degree bend on the end of the wire leaving 3/16" [4.8mm] extending from the bend. Install a brass quick connect onto the throttle arm using the nylon retainer. Enlarge the first hole in the servo arm with a Hobbico Servo Horn Drill (or a #48 or 5/64" [2mm] drill bit). Insert the straight end of the wire into the hole in the brass quick connect. Insert the opposite end through the hole in the servo arm. Install a nylon Faslink onto the servo arm and then center the servo. Center the throttle barrel and then tighten the 4-40 x 1/4" [4-40 x 6mm] socket head cap screw onto the wire.

❑ 16. Cut a small opening in the firewall for the throttle servo wire to pass into the fuselage. Be sure you position the opening in a place that will not obstruct the installation of the fuel tank.

Install the Fuel Tank

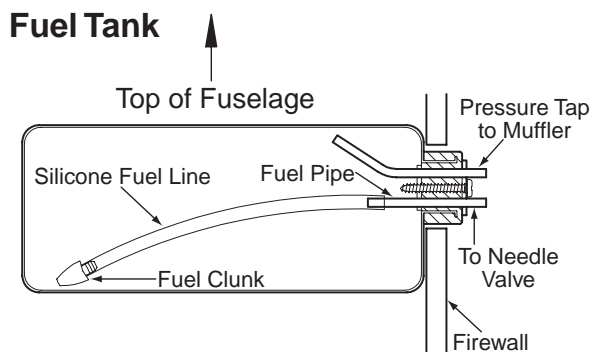

❑ 1. Assemble the **fuel tank** as shown in the sketch. When tightening the center screw be sure not to over tighten it. You just want it snug enough to pull the rubber stopper tight against the tank.

❑ 2. Install the tank into the fuselage with the neck of the tank through the firewall. Hold the tank in place inside the fuselage by wrapping two #64 rubber bands around the tank, attaching the bands to the tabs in the plywood former that supports the tank.

❑ 3. Install silicone fuel tubing (not included in the kit) onto the aluminum tubes from the fuel tank. The line with the fuel clunk will feed to the fuel inlet at the needle valve and the other will attach to the pressure tap on the muffler. For our installation we chose to use an external fill valve. If you choose to do this as well, follow the instructions with your particular brand of fuel valve. Should you choose not to install a fuel filler valve you can fill the fuel tank by removing the fuel line to the carburetor and filling through it. However, depending how you cut out the cowling to accommodate the engine, the cowling may make it difficult to access the carburetor. You can also install a third line to the tank and use it for filling the tank. The method you use is your choice but make your decision before moving onto the installation of the fuel tank.

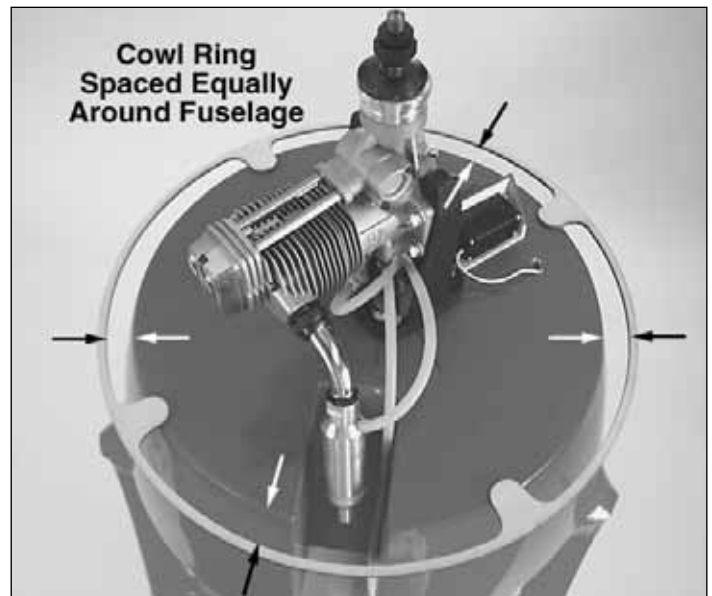

❑ 3. Stand the fuselage on its tail. Place one of the cowl rings on the firewall with the tabs of the ring placed as shown in the picture (this placement is not critical). Make sure the cowl ring is centered and is an equal distance from the sides of the fuselage.

Install the Cowl Ring, Cowl and Dummy Engine

You may already have discovered that the Gee Bee stands on its tail pretty well. For the installation of the cowl you will find it helpful to stand the fuselage on its tail. Temporarily slide the stab into place in the fuselage. This will aid standing it on the tail. Placing a couple of chairs on each side of it will prevent it from accidentally falling over!

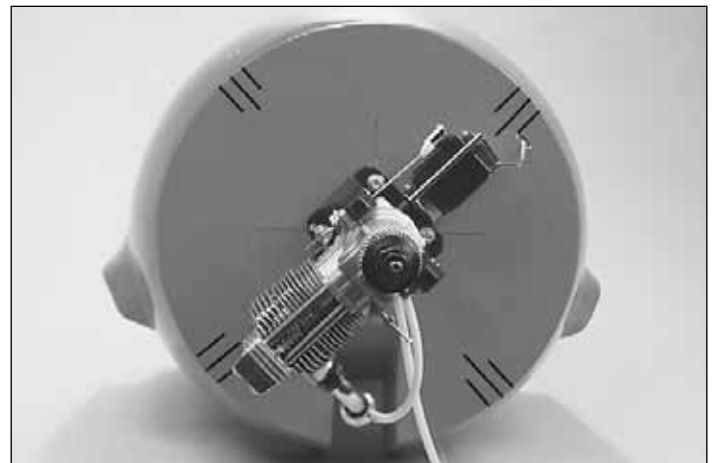

❑ 4. Using the cowl ring as your reference, mark the locations for the plywood mounting tabs with a fine tip felt marker.

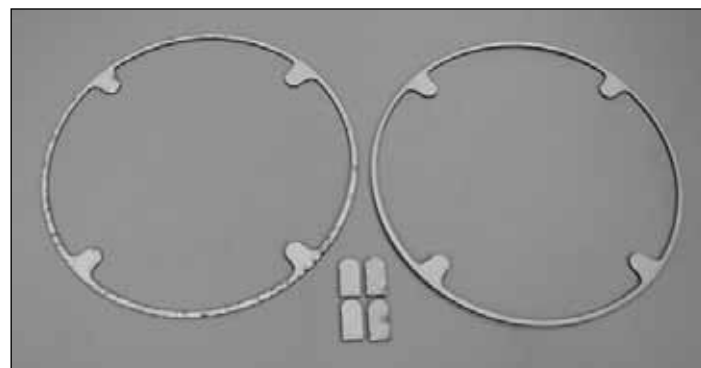

❑ 1. Locate two 1/8" [3mm] plywood **cowl rings** and four 1/8" [3mm] plywood **mounting tabs**.

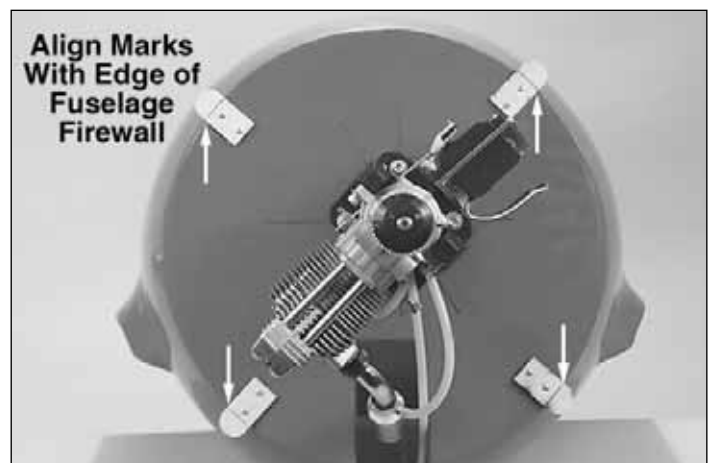

❑ 5. Roughen the area you marked on the firewall with 220-grit sandpaper. Then wipe the area clean with rubbing alcohol.

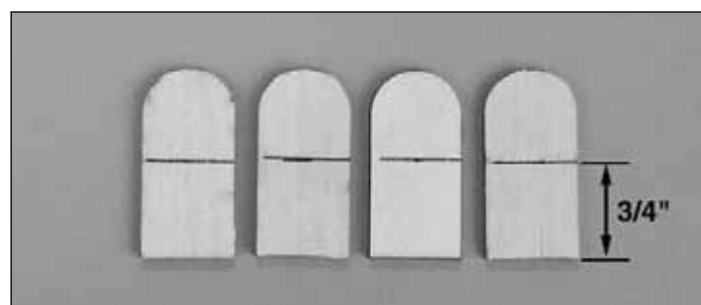

❑ 2. Measure up from the bottom of the tab 3/4" [19mm] and draw a line across it.

Glue the tabs to the firewall with 5-minute epoxy. Align the line on each tab with the edge of the firewall. After the glue has cured drill two 1/16" [1.6mm] holes in each tab and through the firewall. Screw a #2 x 1/2" [#2 x 13mm] sheet metal screw into each of the holes drilled in the tabs. **Note:** When installing the screws, be sure to tighten the outermost screws until they compress into the wood so they are flush with the surface of the tab. This is necessary so when you mount the cowl ring to the tabs the ring sits flat on the mounting tabs.

❑ 6. Glue the two cowl rings together forming one 1/4" [6mm] thick cowl ring.

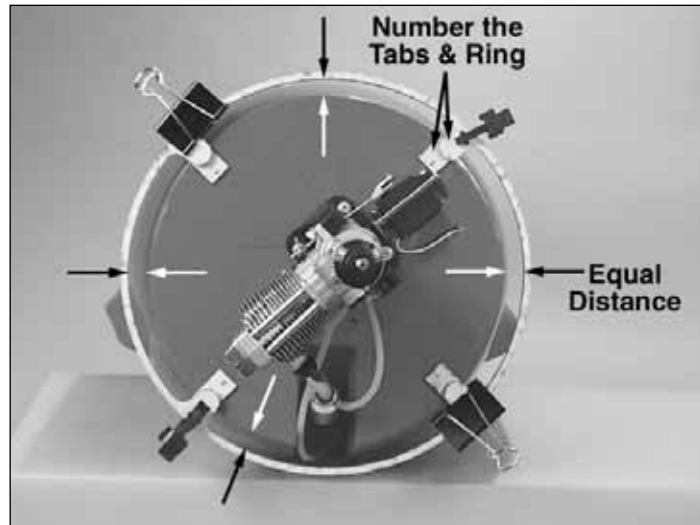

❑ 7. Use small clamps to hold the cowl ring in position on the tabs. Adjust the ring until the distance from the outer edge of the fuselage to the inside edge of the cowl ring is the same all the way around the cowl ring. Number each finger of the cowl ring and number the corresponding mounting tab. You will find this helpful later when matching the cowl ring and the tabs when installing the cowl.

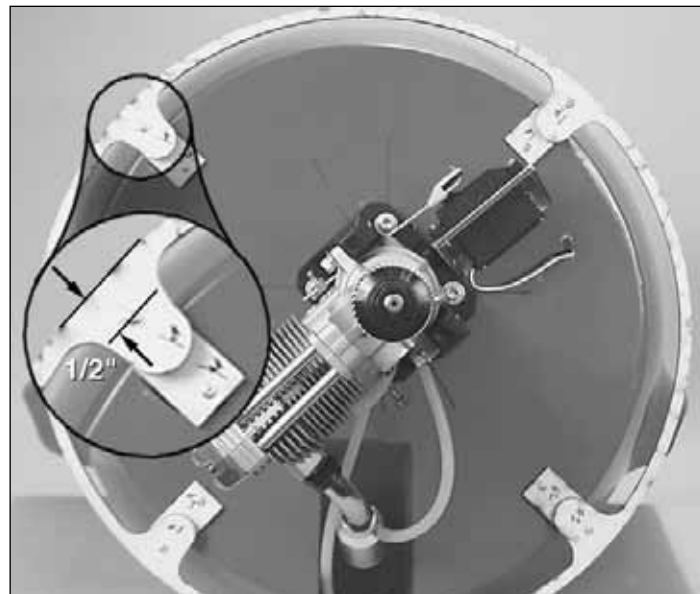

❑ 8. With the cowl ring still being held in place with the clamps, on one tab measure 1/2" [13mm] from the outer edge of the cowl ring towards the fuselage. Make this mark in the

center of the tab. On the mark, drill through the ring and the mounting tab with a 1/16" [1.6mm] drill bit. Remove the clamp and screw a #2 x 1/2" sheet metal screw through the cowl ring and into the mounting tab. Repeat this for all four tabs.

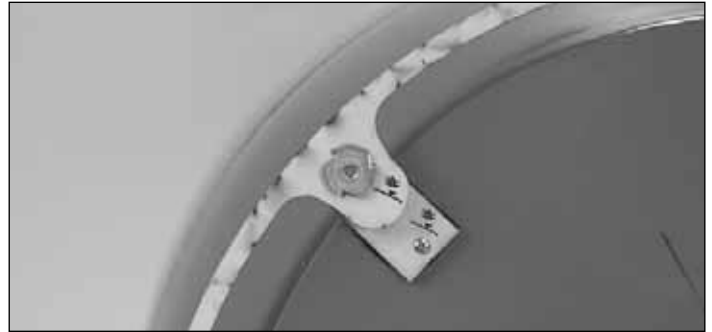

❑ 9. Remove one of the screws from one tab. Drill a 1/8" [3mm] hole through the hole the screw was in on both the cowl ring and the tab. Now drill a 5/32" [4mm] hole through the cowl ring and the tab (*drilling through the holes with a progressively larger bit prevents the plywood from splitting*). Insert a 6-32 blind nut into the cowl ring. Use a small amount of epoxy to glue the blind nut to the cowl ring.



❑ 10. Install a 6-32 x 1/2" [6-32 x 13mm] socket head cap screw and a #6 washer through the back side of the mounting tab and into the blind nut in the cowl ring. Tighten the screw to the blind nut.

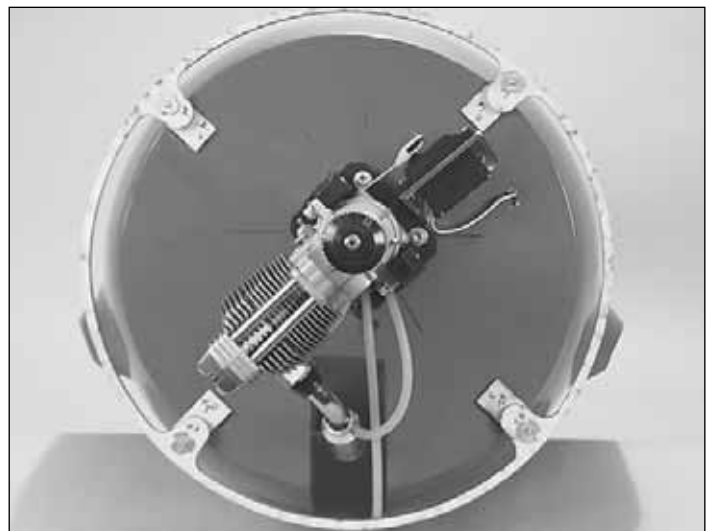

❑ 11. Remove a screw from another tab and repeat the same procedure of installing a bolt, washer and blind nut. Do this to all four mounting tabs, mounting the ring to the fuselage.

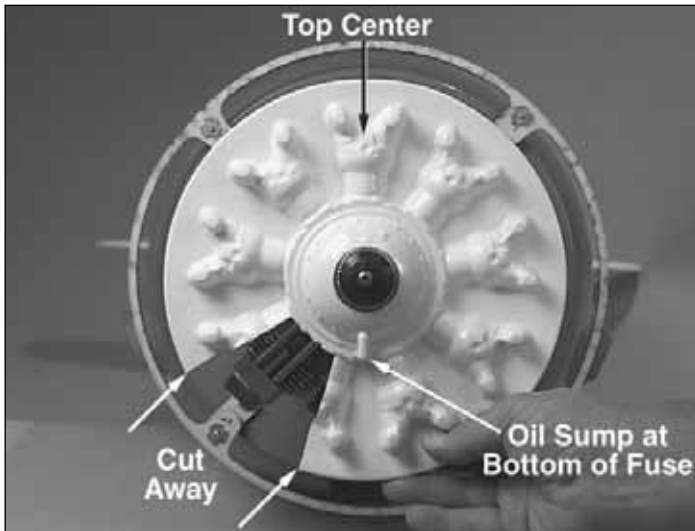

12. Cut a hole in the center of the **dummy engine** large enough to clear the thrust washer of the engine. Position the dummy engine over the engine. For proper positioning the oil sump should be at the bottom of the fuselage and the top cylinder should be at the top-center of the fuselage. Mark the area where the dummy engine covers the engine's cylinder head. Cut this part of the dummy engine away.

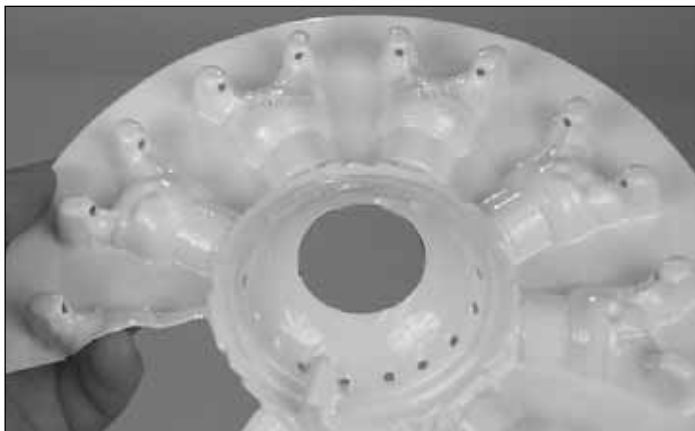

13. Drill 1/8" [3mm] holes into the bottom-center of each rocker cover and on the marks on the case of the dummy engine.

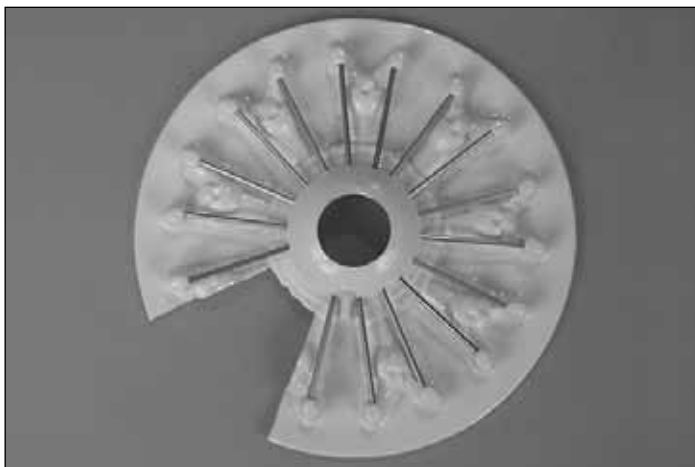

14. Insert a 1/8" x 3" [3mm x 76mm] **aluminum tube** in each of the holes you drilled. Make sure that each fits well, and then remove the tubes from the engine.

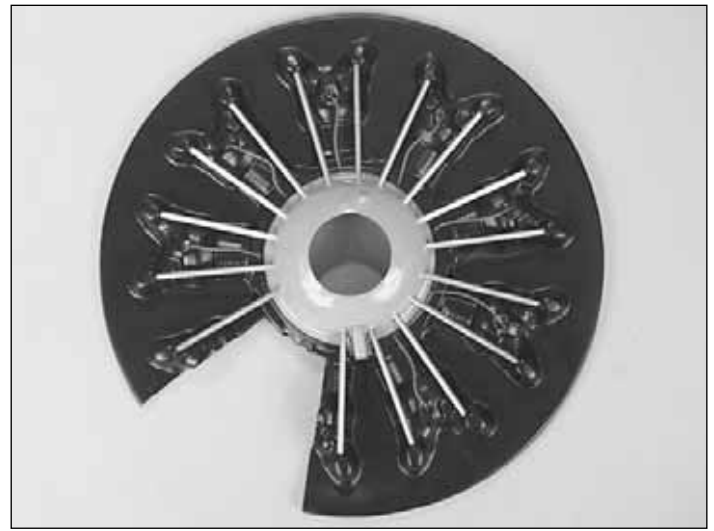

15. Paint the dummy engine with a fuel proof paint. Paint the cylinders and the area around them flat black and the engine case a light gray. After the paint is dry insert the aluminum tubes into the dummy engine. Hold them in place by applying a small amount of epoxy to each tube on the back side of the dummy engine. You can add additional detail to the dummy engine by drilling a small hole in each cylinder to accept the spark plug wires. Use small gauge wire (not included) for the spark plug wires.

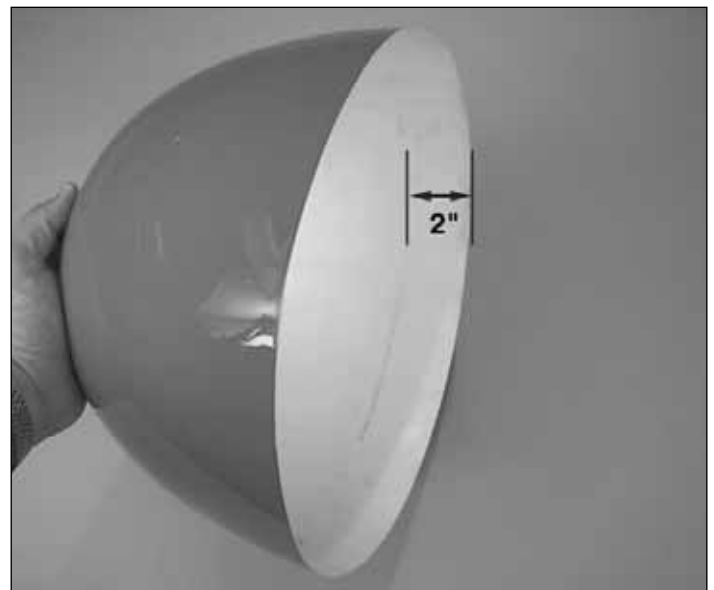

16. Measure into the cowl from the trailing edge of the cowling 2" [50mm] and make a few reference marks. Using 220-grit sandpaper, sand the entire inside of the cowl in the area that you have made the marks. This is the area the cowl ring will contact the cowl. Sand the front 1-1/2" [38mm] of the inside of the cowl to prepare it for the dummy engine. Wipe the areas you've sanded with rubbing alcohol to clean away the residue.

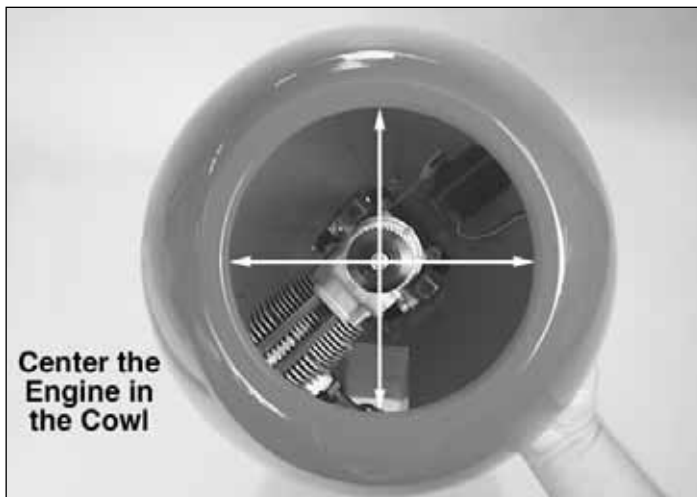

❑ 17. Place the cowl onto the ring, centering the cowl on the engine. Do not push the cowl onto the cowl mounting ring too hard as this could deform the shape of the cowl.

❑ 18. Reaching carefully into the inside of the cowl, tack glue the cowl to the cowl mounting ring with medium CA. Be sure you do not move the cowl while reaching inside. Spray the glue with accelerator to make sure the glue is fully cured.

❑ 19. Once the glue is fully cured, remove the cowl and the cowl mounting ring from the fuselage by removing the four socket head cap screws that hold the cowl to the fuselage. Apply a small bead of medium CA to firmly attach the cowl mounting ring to the cowl. Allow the CA to fully cure.



❑ 20. Mix 1/4 ounce of 6-minute epoxy with microballoon filler. Apply a fillet of the epoxy to the cowl mounting ring and the cowl. The fillet should be made on the front of the cowl mounting ring. Applying the epoxy to the back of the ring could interfere with the cowl mounting tabs.

❑ 21. Now is a good time to make any cut-outs in the cowl for things such as a needle valve extension, choke extension or a remote glow adapter. If you are using a long-necked Nicd glow driver there is no need for a remote glow plug adapter. For our installation we chose to use a Sullivan Head Lock Remote (MODP1221). Re-install the cowl onto the fuselage. This will allow you to look into the front of the cowl to determine exactly where any holes may have to be drilled. When you have finished, remove the cowl.

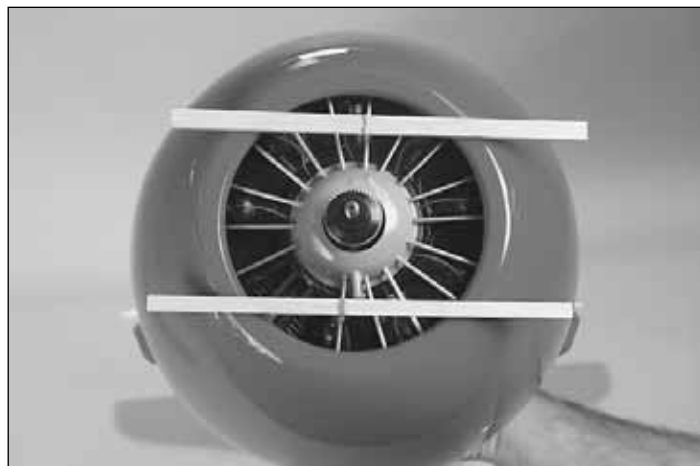

❑ 22. With the fuselage standing on its tail, place the dummy engine over the engine. Then place the cowl over the dummy engine. Attach the cowl to the fuselage with the four socket head cap screws. To position the dummy engine you will need two 9" [229mm] balsa sticks and two small rubber bands (not included). Loop a rubber band through a couple of the aluminum tubes on one side of engine crankshaft. Insert the stick through the rubber bands and place the stick onto the front of the cowl. This will pull the dummy engine into the front of the cowl. Repeat this with the second stick and rubber band on the other side of the engine crankshaft.



❑ 23. Position the dummy engine so that the cut out is over the engine cylinder and the hole you cut in the center of the dummy engine is centered on the engine thrust washer. Be sure the center cylinder on the dummy engine is centered at the top of the fuselage and the oil sump is centered on the bottom of the fuselage. When you are satisfied with the positioning of the dummy engine, carefully remove the cowl from the fuselage being careful not to disturb the dummy engine.

❑ 24. Tack-glue the dummy engine to the cowl from inside the cowl. Re-install the cowl to the fuselage to verify that the dummy engine is placed properly. When you are satisfied with the way it fits, remove the cowl from the fuselage and permanently glue the dummy engine to the cowl from inside the cowl with 6-minute epoxy mixed with microballoon filler.

Mount the Stab, Elevator, Rudder and Tailwheel

❑ 1. Temporarily install the wing onto the fuselage with two 1/4-20 nylon **wing bolts**.

❑ 2. Trial fit the **horizontal stabilizer** into the stabilizer saddle at the rear of the fuselage. You may find it necessary to sand inside the stabilizer saddle to remove any excess fiberglass resin that may have accumulated in the molding process.

❑ 3. Once you are satisfied with the fit of the stabilizer remove it from the fuselage. Using 220-grit sandpaper, lightly sand the inside of the stabilizer saddle and the immediate area inside the fuselage surrounding it. After you have sanded the area, wipe the area clean with rubbing alcohol.

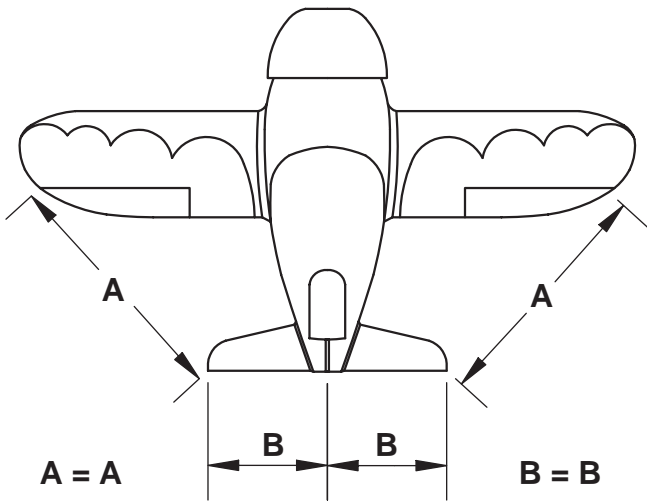

❑ 4. Re-install the stabilizer into the stabilizer saddle in the fuselage. Center the stabilizer in the fuselage as shown in the above sketch.



❑ 5. Once you have the stabilizer properly centered, use a fine line felt tip pen to mark where the stab contacts the fuselage. Mark both the top and bottom of the stabilizer.

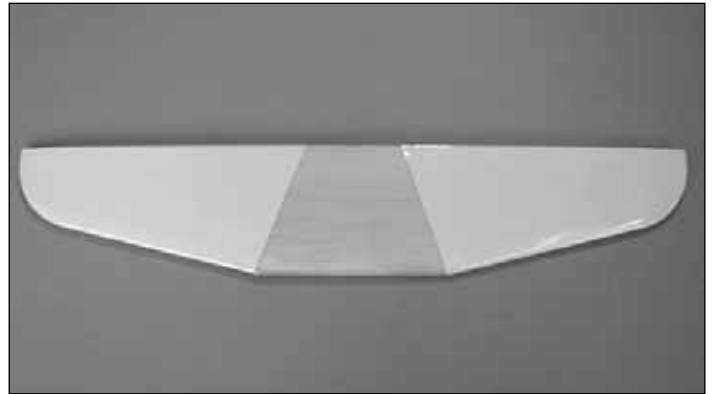

❑ 6. Remove the stab from the fuselage. Use the same technique used for cutting the covering from the wing to remove the covering from the top and bottom of the stab. Use care to cut **only into the covering** and **not** into the wood.

❑ 7. Using 6-minute epoxy, glue the stab to the stab saddle. Double check the alignment of the stab to the wing before the glue cures. You can clean any excess epoxy from the fuselage and stab with rubbing alcohol anytime before the glue cures. **Note:** Do not be too concerned about getting a large amount of epoxy between the stab and the stab saddle. Just get enough glue into the joint to hold it in place. In the next step you will remove the wing and a solid glue joint will be made inside of the fuselage.

❑ 8. Remove the wing from the fuselage. Mix a small amount of 6-minute epoxy. Using a small stick, reach into the fuselage and force the epoxy into the stab saddle and stab to create a solid bond of the stab to the fuselage. You may find it helpful to add a small amount of microballoon filler to the glue. This will thicken the glue slightly preventing it from running out of the joint too easily. Allow the glue to cure before starting the next step.

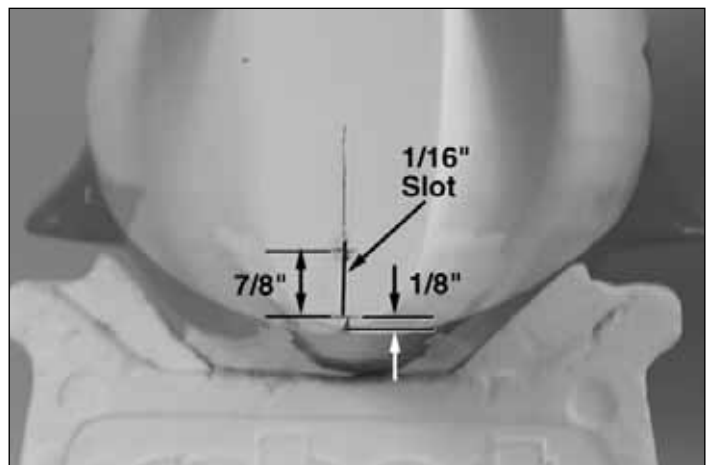

❑ 9. On the end of the fuselage at the tailpost, measure up from the bottom of the fuselage 1/8" [3mm] and make a line. Measure up from this mark 7/8" [22mm] and make another line. Between these two marks draw the centerline of the fuselage. On the centerline, between the two lines you have drawn, cut a 1/16" [1.6mm] slot. You will find that this is most easily accomplished with the use of a high speed rotary tool and a fiberglass cut-off wheel.

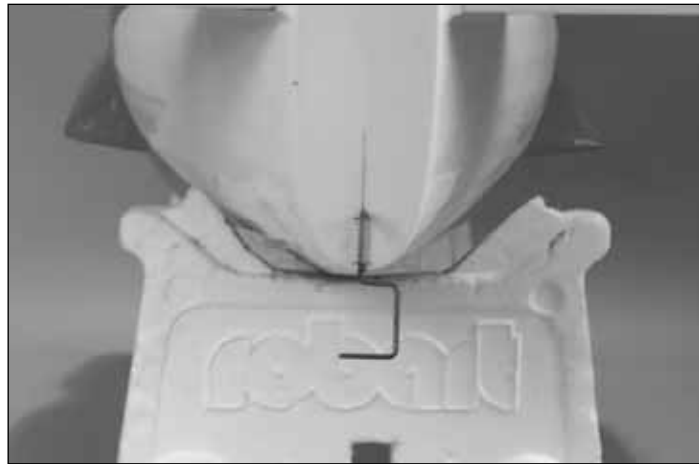
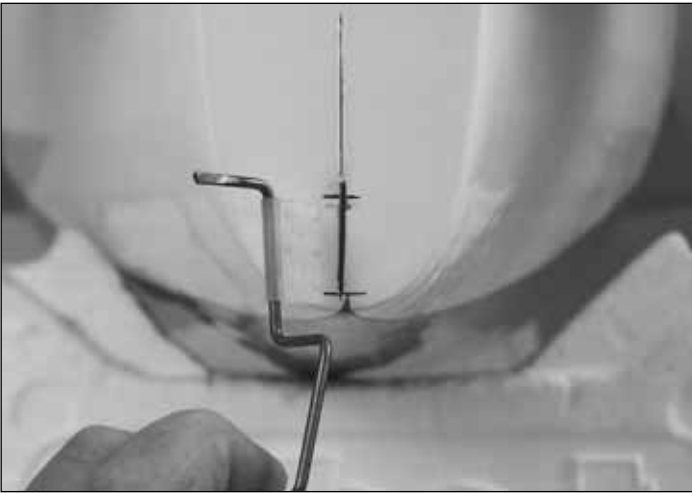

❑ 10. Locate the **tailwheel** assembly. Trial fit the nylon bearing into the slot you have cut. Adjust the slot as needed until the nylon bearing fits into the slot.

❑ 11. Apply a small amount of petroleum jelly to the ends of the nylon bearing to prevent glue from getting into the nylon bearing and the tailwheel wire. Glue the nylon bearing into the slot in the fuselage with 6-minute epoxy.

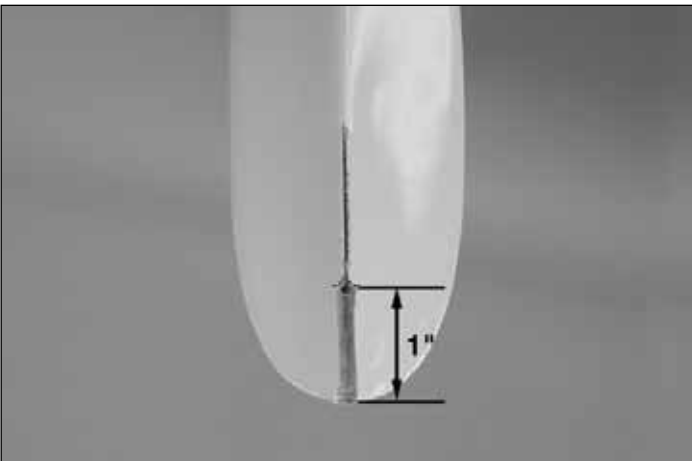

❑ 12. On the leading edge of the rudder measure up from the bottom of the rudder 1" [25mm] and make a mark. On this mark drill a 7/64" [2.8mm] hole into the leading edge of the rudder. Make a 1/8" [3mm] slot 1/8" [3mm] deep in the leading edge of the rudder from this hole to the bottom of the rudder.

❑ 13. Trial fit the rudder by sliding the rudder onto the tailwheel wire. The nylon bearing should fit into the slot you have cut in the rudder. Adjust the slot as needed until the leading edge of the rudder is in contact with the trailing edge of the fuselage. Remove the rudder and put a couple of drops of thin CA into the hole to harden the wood. After the glue has cured re-insert the rudder onto the tailwheel wire to be sure everything still fits well.

❑ 14. Install three CA hinges using the same method as used for the ailerons. Mix a small amount of 6-minute epoxy. Work some epoxy into the hole you drilled in the rudder. Slide the rudder onto the tailwheel wire and the hinges. When you are satisfied with the fit apply 6 drops of CA glue to each hinge. Be careful not to let the glue run onto the fuselage.



❑ 15. Install a 4-40 set screw into each of the two 1/8" [3mm] wheel collars. Slide a wheel collar onto the tailwheel wire, then the tailwheel followed by another wheel collar. Tighten the set screws in the wheel collars, centering the tailwheel between them. Filing flat spots on the wire where the wheel collars contact the wire will make a more secure installation for the wheel collars.

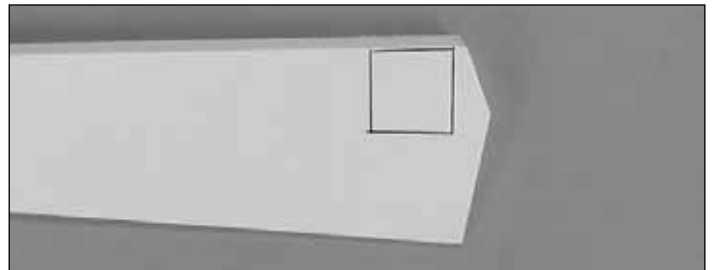

❑ 16. Locate the left and right **elevator** halves. On one side of each elevator you can see the outline of a hardwood plate

under the covering. Use a pin to determine that you have located the hardwood plate. **Important!** This is the bottom of the elevator. The control horns mount to these plates and when installed properly the plates are on the bottom of the elevator. Determine which elevator is for the right side and left side and then install them to the horizontal stab with three hinges on each elevator. Use the same installation procedure used for the ailerons and rudder.

Install the Elevator and Rudder Servos, Radio System and Pushrods

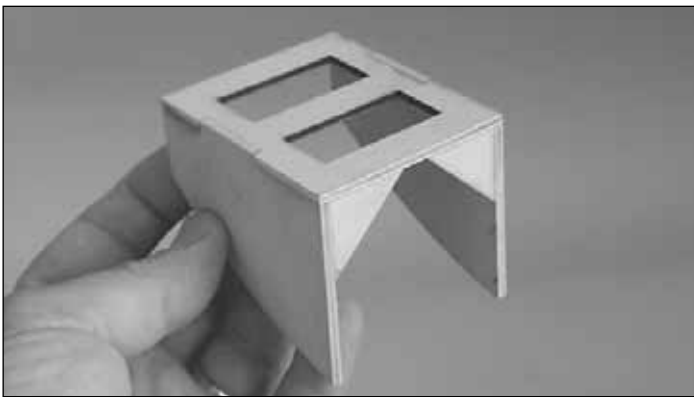
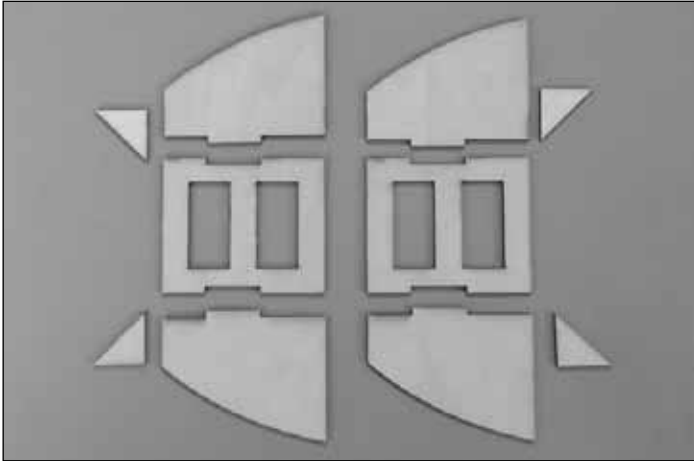

❑ 1. Locate the 1/8" [3mm] plywood servo tray components. Glue them together as shown to form two servo trays.

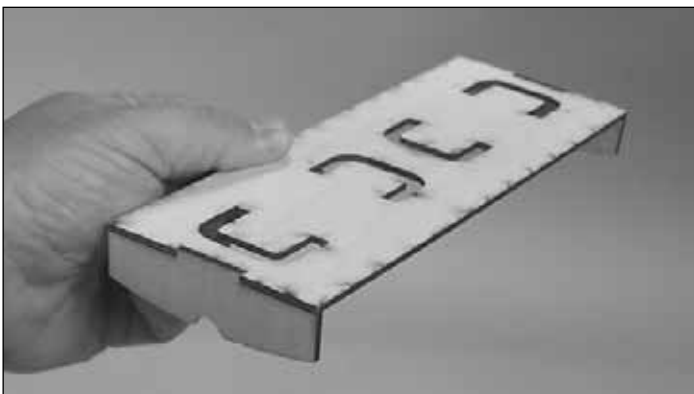

❑ 2. Locate the 1/8" [3mm] plywood battery/receiver tray and two formers. Glue the tray together as shown.

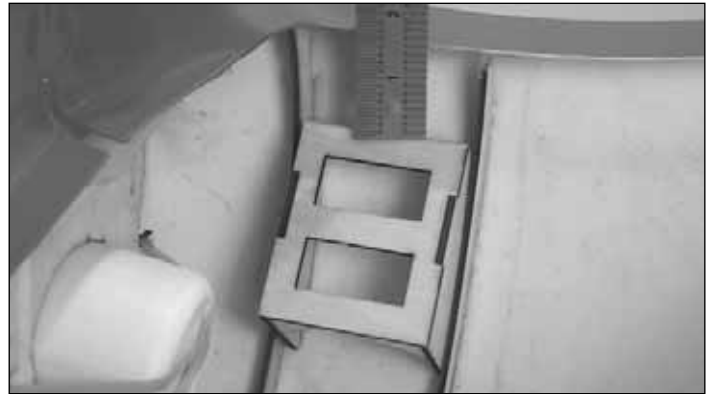

❑ 3. Place one servo tray between the plywood formers inside of the fuselage. Measure down from the wing saddle to the top of the box 1-1/2" [38mm]. Make a reference mark for positioning the servo tray when gluing it in place. Glue the servo tray to the plywood formers and the fuselage.

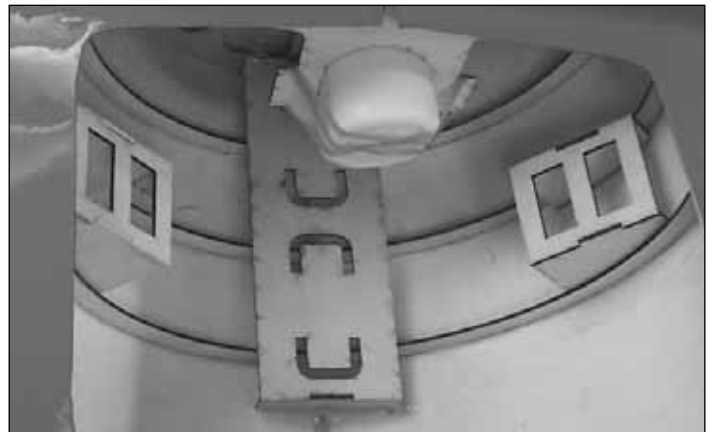

❑ 4. Position the battery/receiver tray inside the fuselage as shown. Make reference marks inside the fuselage identifying where the formers contact the fuselage. Sand the areas where the formers will contact the fuselage with 220-grit sandpaper. Then wipe the area clean with rubbing alcohol. Glue the tray to the fuselage with a mixture of 6-minute epoxy and microballoon filler. Use a liberal amount of the mixture creating a fillet of the mixture between the formers and the fuselage.

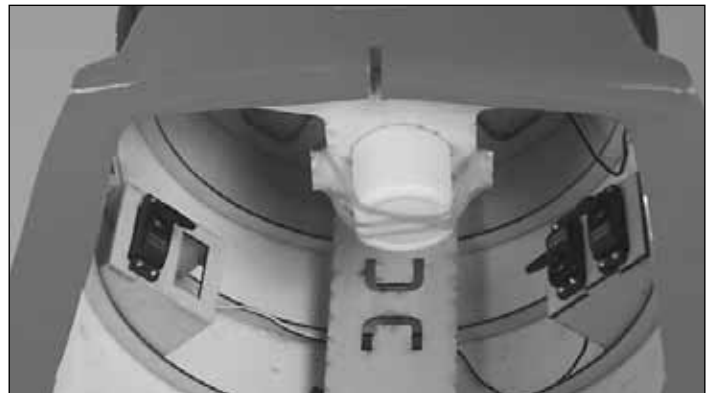

❑ 5. Install three servos, positioning them as shown. Drill 1/16" [1.6mm] holes for each servo screw. Install the screw into the servo tray and then remove the screw. Apply a couple of drops of thin CA to harden the wood. After the glue has cured, install the servos with the hardware provided.

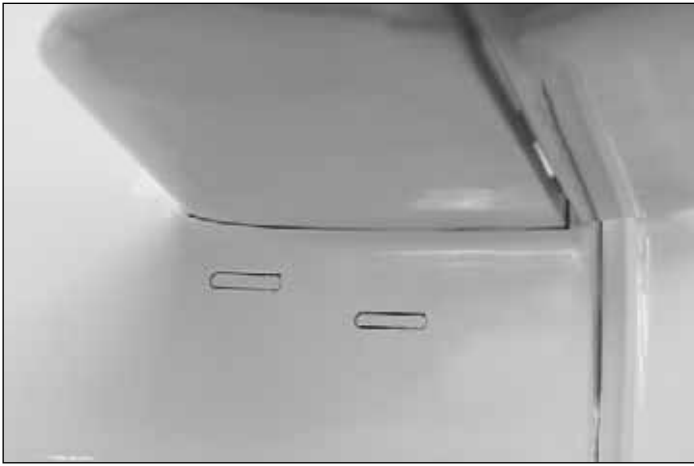

6. On the left side of the fuselage below the stab are located two molded pushrod exit locations. Cut them out. On the right side of the fuselage is located one molded pushrod exit. Cut it out as well.

7. Locate three .074 x 17-1/2" [444mm] wires threaded on one end. From one wire cut a 6-1/2" [165mm] rod with the threads at one end.

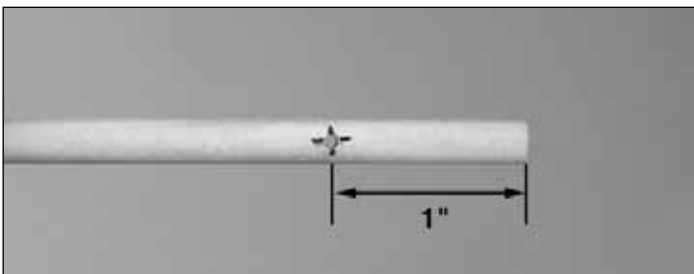

8. Locate three 1/4" x 16" [6mm x 406mm] **wood dowels**. On one dowel measure from one end 1" [25mm] and make a mark. On the mark, drill a 5/64" [2mm] hole through the dowel.

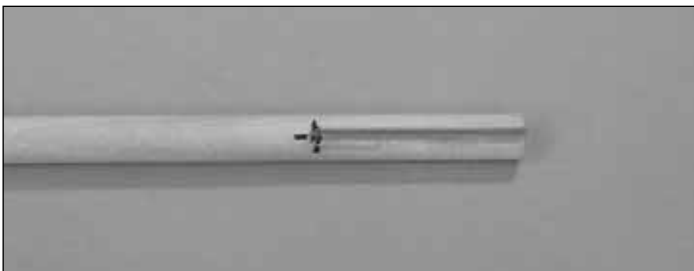

9. From the end of the dowel to the hole make a groove the same width as the pushrod wire.



10. On the non-threaded end of the 6-1/2" [165mm] wire make a 90 degree bend 1/4" [6mm] from the end of the wire.

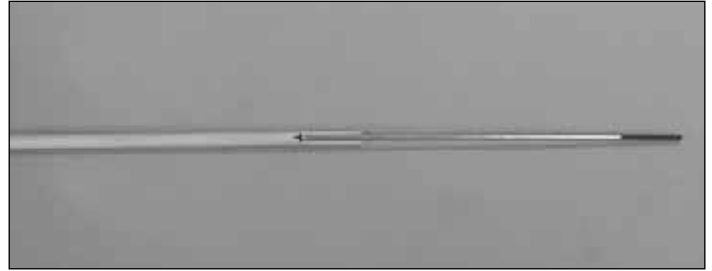
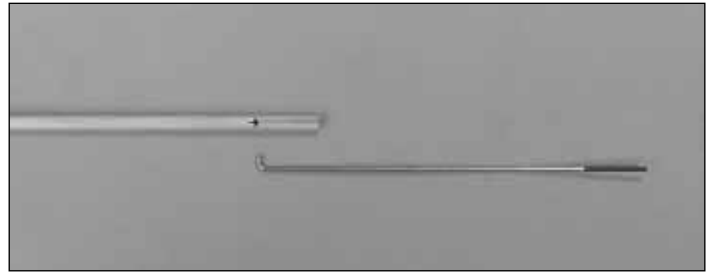

11. Insert the wire into the hole in the dowel. Glue the wire to the groove with a small amount of medium CA.

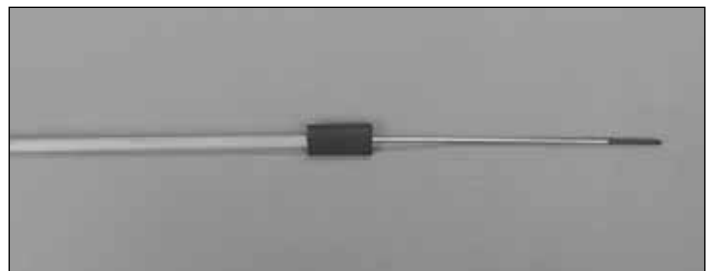

12. Locate one of the 2-3/8" [60mm] long pieces of **heat shrink tubing**. Cut it in half. Slide one piece over the wire and the dowel. Then shrink the tubing tightly to the dowel and wire. The tubing can be shrunk with either a modeling heat gun or a match.

13. From the leftover .074 x 17-1/2" [444mm] wire cut a 7-1/2" [190mm] long, non-threaded wire. Make a 90 degree bend 1/4" [6mm] from the end of the wire.

14. On the opposite end of the dowel measure in 1" [25mm] and make a mark. On the mark, drill a 5/64" [2mm] hole through the dowel.

15. From the end of the dowel to the hole make a groove.

16. Insert the wire into the hole in the dowel. Glue the wire to the groove with a small amount of medium CA.

17. Slide the remaining half of the heat shrink tubing over the wire and dowel. Shrink the tubing tightly to the dowel and wire.

❑ 18. Repeat steps 7 - 17 to make a second, matching pushrod.

❑ ❑ 19. Install a clevis and silicone clevis keeper to the threaded end of the wire the same as was done with the ailerons.

❑ ❑ 20. Insert the end of the pushrod wire with the clevis into the fuselage and out through the most forward of the two pushrod exit holes.

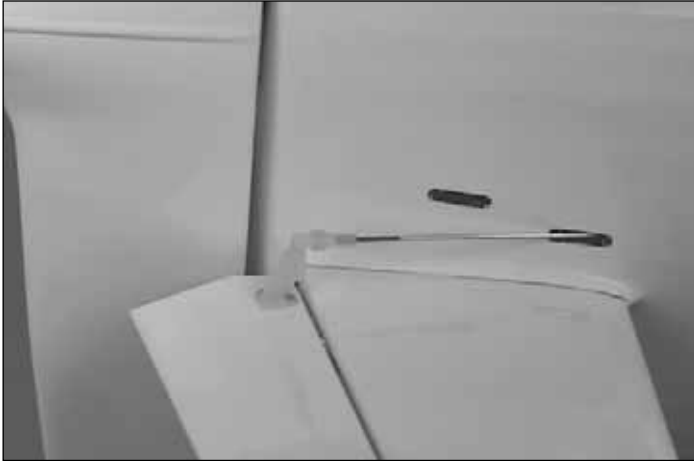

❑ ❑ 21. Install a control horn onto the bottom of the elevator with two #2 x 1/2" [13mm] sheet metal screws following the same procedure used for the ailerons. Be sure the control horn is aligned with the pushrod and is on the hardwood plate in the bottom of the elevator.

❑ 22. Repeat steps 19 - 21 for the opposite elevator.



❑ 23. Center both elevators and the elevator servos. The elevator servos are located in the lower servo bays on both sides of the fuselage. Attach the pushrods to the elevator servos using nylon Faslinks following the same procedure used for the ailerons.

❑ 24. From the remaining .074 x 17-1/2" [444mm] wire cut a 6-1/2" [165mm] long rod threaded on one end.

❑ 25. On the remaining dowel measure up 1" [25mm] at both ends of the dowel and make a mark. On the mark, drill a 5/64" [2mm] hole through the dowel on both ends.

❑ 26. From the ends of the dowel to the holes make grooves.

❑ 27. On the non-threaded end of the 6-1/2" [165mm] wire make a 90 degree bend 1/4" [6mm] from the end of the wire.

❑ 28. Insert the wire into the hole in the dowel. Glue the wire to the groove with a small amount of medium CA.

❑ 29. Locate the remaining 2-3/8" [60mm] long pieces of heat shrink tubing. Cut it in half. Slide one piece over the wire and the dowel and shrink the tubing tightly to the dowel and wire.

❑ 30. From the leftover .074 x 17-1/2" [444mm] wire cut an 8" [203mm] long wire. Make a 90 degree bend 1/4" [6mm] from the end of the wire. Insert the wire into the hole in the dowel. Glue the wire to the groove with a small amount of medium CA. After the glue has cured, insert and heat the final piece of heat shrink tubing to the end of the dowel.

❑ 31. Install a clevis and silicone clevis keeper to the threaded end of the wire the same as was done with the elevators.

❑ 32. Insert the end of the pushrod wire with the clevis into the fuselage and out through the remaining pushrod exit hole on the left side of the fuselage.



❑ 33. Install a control horn onto the left side of the rudder. When placing the control horn it must be aligned with the rudder pushrod wire and be aligned with the plywood plate located under the fiberglass skin of the rudder. If you press lightly on the fiberglass on the left side of the rudder you can feel where the plate is because the fiberglass will be noticeably stiffer in that area. When placing the control horn it will have to be set back from the leading edge of the rudder 1/8" [3mm]. When satisfied with the placement mark the mounting hole locations for the control horn. Drill a 1/16" [1.6mm] hole through both marks. Insert and then remove a #2 x 1/2" [13mm] sheet metal screw through each hole. Apply a couple of small drops of thin CA into the holes. After the glue has cured install a large nylon control horn to the rudder with the two #2 sheet metal screws.



□ 34. Center the rudder and the rudder servo. Attach the pushrod to the rudder servo using nylon Faslinks following the same procedure used for the elevator. The final servo installation should look as shown above.

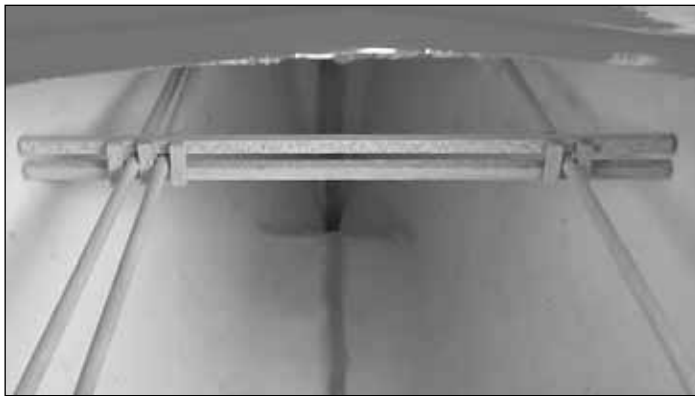

□ 35. Locate two 1/4" x 1/4" x 24" [6mm x 6mm x 610mm] wood sticks. Cut one stick into two 10-3/4" lengths. Roughen, then wipe the area of the fuselage where the stick will be glued with rubbing alcohol. Glue the sticks into the fuselage above and below the pushrods to support them. From the remaining stick cut small pieces and glue them to the wood sticks to support the sides of the pushrods. Be sure there is no binding of the pushrods when you have finished gluing the sticks in place.

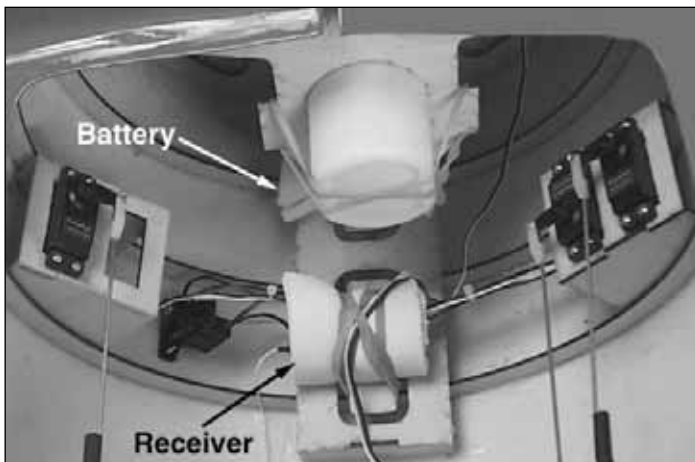

□ 36. Wrap the battery pack and receiver in at least 1/4" of R/C foam rubber and install them in the fuselage. On our model the battery and receiver were mounted where shown

in the photo to minimize the amount of nose weight required to balance the model at the correct C.G. Securely hold the battery pack and receiver in position with #64 rubber bands on the battery/receiver tray in the top of the fuselage.

□ 37. Connect a Y-harness to the aileron servo wires in the wing. Secure the connections with heat shrink tubing, tape or clips intended for that purpose. Install a 12" aileron extension to the receiver for the ailerons.

□ 38. Mount the receiver on/off switch. A Great Planes Switch & Charge Jack Mounting Set (GPMM1000, not included) was used on this model. Be certain it is in a location away from engine exhaust.

□ 39. Make certain all the servo arms are secured to the servos with the screws that came with them and that all the clevises have retainers on them.

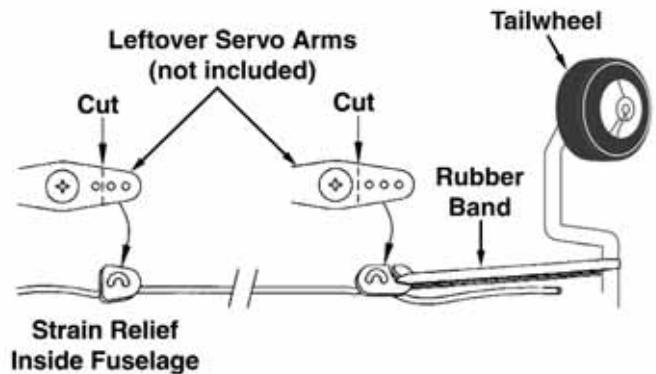

□ 40. Extend the receiver antenna, guiding it out of the fuselage and connecting it to the tailwheel. Be certain there is a strain relief inside the fuselage on the antenna to keep stress off the solder joint inside the receiver. On our prototype we drilled a 7/32" [5.6mm] hole through the bottom of the fuse, installed a 1" [25mm] length of fuel tubing into the hole and routed the antenna through the tubing. A strain relief as shown in the sketch was used inside the fuselage and the end of the antenna was connected to a small rubber band that wraps around the tailwheel.

Finishing Touches

1. Paint the pilot and install it in the cockpit area.
2. Trim, then glue the canopy in place. You can use either aliphatic glue or if done carefully you can use 6-minute epoxy as we did on our prototype.
3. Use scissors or a sharp hobby knife to cut the decals from the sheet.



4. These photos will help you in placing the decals. On the decal sheet there are sections of red and black material that can be used to fill the gap on the numbers between the

wing and the aileron. **Note:** The bottom of the wing has the same decals as the top but the N-number is on the left side and the number "7" is on the right.

5. Be certain the model is clean and free from oily fingerprints and dust. Prepare a dishpan or small bucket with a mixture of liquid dish soap and warm water—about one teaspoon of soap per gallon of water. Submerge the decal in the soap and water and peel off the paper backing. **Note:** Even though the decals have a "sticky-back" and are not the water transfer type, submersing them in soap & water allows accurate positioning and reduces air bubbles underneath.
6. Position decal on the model where desired. Holding the decal down, use a paper towel to wipe most of the water away.
7. Use a piece of soft balsa or something similar to squeegee remaining water from under the decal. Apply the rest of the decals the same way.

GET THE MODEL READY TO FLY

Check the Control Directions

1. Turn on the transmitter and receiver and center the trims. If necessary, remove the servo arms from the servos and reposition them so they are centered. Reinstall the screws that hold on the servo arms.
2. With the transmitter and receiver still on, check all the control surfaces to see if they are centered. If necessary, adjust the clevises on the pushrods to center the control surfaces.

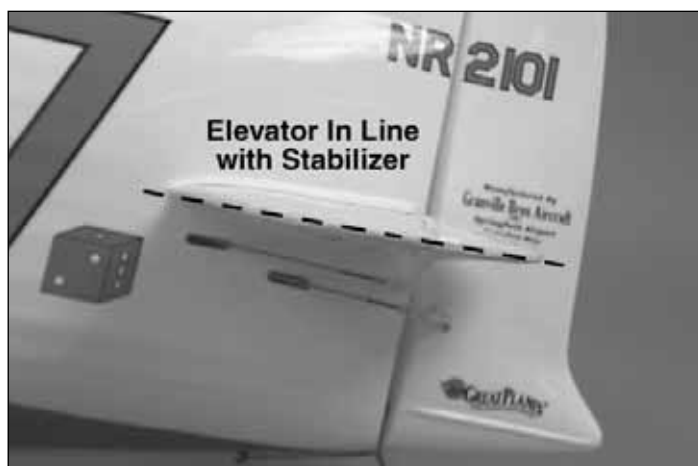

IMPORTANT NOTE ABOUT SETTING UP THE ELEVATOR.

In our testing we have designed all of this airplane's incidences so that when the elevator is neutral it should be in line with the horizontal stab. Be sure the elevator is positioned as shown. If your plane is properly balanced as explained later in this manual, the elevator should be fairly close to the neutral trim setting.

4-CHANNEL RADIO SETUP (STANDARD MODE 2)

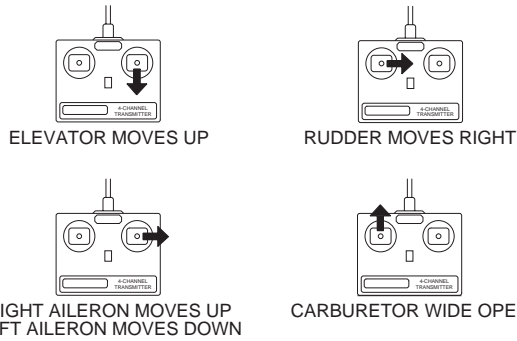

3. Make certain that the control surfaces and the carburetor respond in the correct direction as shown in the diagram. If any of the controls respond in the wrong direction, use the servo reversing in the transmitter to reverse the servos connected to those controls. Be certain the control surfaces have remained centered. Adjust if necessary.

Set the Control Throws



Use a Great Planes AccuThrow (or a ruler) to accurately measure and set the control throw of each control surface as indicated in the chart that follows. **NOTE:** The throws are measured at the widest part of the elevators, rudder and ailerons.

These are the recommended control surface throws:

ELEVATOR:	5/8" [15.9mm] up 5/8" [15.9mm] down
RUDDER:	1" [25mm] right 1" [25mm] left
AILERONS:	7/8" [22.2mm] up 7/8" [22.2mm] down

IMPORTANT: The Gee Bee has been **extensively** flown and tested to arrive at these throws. We have tested a range of control throws and have found that **you must** set them as listed above. With these throws the model performs very well and will not snap or roll violently. Coupled with these throws, your properly balanced model will perform very well.

Balance the Model (C.G.)

More than any other factor, the **C.G.** (balance point) can have the **greatest** effect on how a model flies and may determine whether or not your first flight will be successful. If you value this model and wish to enjoy it for many flights, **DO NOT OVERLOOK THIS IMPORTANT PROCEDURE.** A model that is not properly balanced will be unstable and possibly unflyable.

At this stage the model should be in ready-to-fly condition with all of the systems in place including the engine, landing gear, covering and paint and the radio system.

1. Use a felt-tip pen or 1/8"-wide tape to accurately mark the C.G. on the top of the wing on both sides of the fuselage. **The C.G. is located 2-3/4" [70mm] back from the leading edge of the wing.**

This is where your model should balance. For the Gee Bee **we do not recommend** that you move the C.G. forward or back from this point. In our testing we found that moving the C.G. too far aft causes the plane to snap with the recommended elevator control throw. Moving the C.G. forward did not add to the overall stability of the plane and only caused the plane difficulties while flaring for landing.

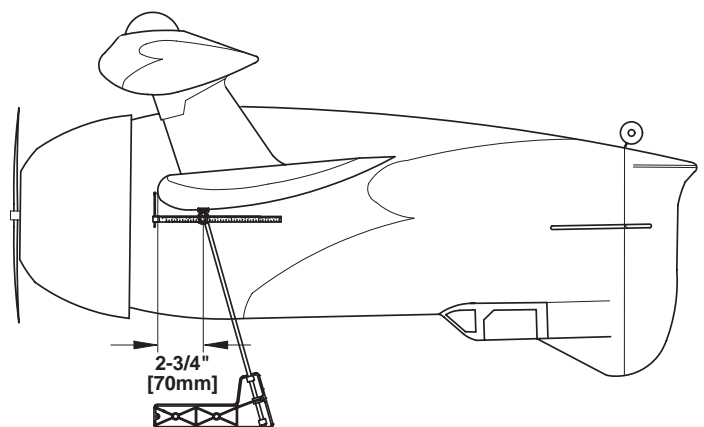

2. With the wing attached to the fuselage, all parts of the model installed (ready to fly) and an empty fuel tank, place the model upside-down on a Great Planes CG Machine. If you are using the C.G. Machine you will have to use longer rods for the base of the machine due to the width of the fuselage. If you do not wish to do this you can remove the balancing rods, place the pads on the C.G. location and lift the model while holding onto the rods.



If you do not have a C.G. machine we recommend that you balance the plane as shown here. Mark the location for the C.G. on the wing, close to the wing saddle. Remove the wing, and then wrap a lightweight cord or wire around the fuselage. Put the wing back onto the fuselage. Suspend the airplane from the cord, making sure the cord is on the marks you have made.

IMPORTANT! DO NOT BALANCE THE AIRPLANE WITH YOUR FINGERS!

The C.G. range is critical and there is not a lot of margin for moving the C.G. forward or aft of the recommended location. Balancing with your fingers is not accurate enough for balancing this model.

3. If the tail drops, the model is “tail heavy” and the battery pack and/or receiver must be shifted forward or weight must be added to the nose to balance. If the nose drops, the model is “nose heavy” and the battery pack and/or receiver must be shifted aft or weight must be added to the tail to balance. If possible, relocate the battery pack and receiver to minimize or eliminate any additional ballast required. If additional weight is required, nose weight may be easily added by using a “spinner weight” (GPMQ4645 for the 1 oz. weight, or GPMQ4646 for the 2 oz. weight). If spinner weight is not practical or is not enough, use Great Planes (GPMQ4485) “stick on” lead. A good place to add stick-on nose weight is to the firewall (don’t attach weight to the cowl—it is not intended to support weight). Begin by placing incrementally increasing amounts of weight on the fuse over the firewall until the model balances. Once you have determined the amount of weight required, it can be permanently attached.

Note: Do not rely upon the adhesive on the back of the lead weight to permanently hold it in place. Over time, fuel and exhaust residue may soften the adhesive and cause the weight to fall off. Use #2 sheet metal screws, RTV silicone or epoxy to permanently hold the weight in place.

4. **IMPORTANT:** If you found it necessary to add any weight, recheck the C.G. after the weight has been installed.

Balance the Model Laterally

1. With the wing level, have an assistant help you lift the model by the engine propeller shaft and the bottom of the fuse under the TE of the fin. Do this several times.

2. If one wing always drops when you lift the model, it means that side is heavy. Balance the airplane by adding weight to the other wing tip. **An airplane that has been laterally balanced will track better in loops and other maneuvers.**

PREFLIGHT

Identify Your Model

No matter if you fly at an AMA sanctioned R/C club site or if you fly somewhere on your own, you should always have your name, address, telephone number and AMA number on or inside your model. It is **required** at all AMA R/C club flying sites and AMA sanctioned flying events. Fill out the identification tag on the decal sheet and place it on or inside your model.

Charge the Batteries

Follow the battery charging instructions that came with your radio control system to charge the batteries. You should always charge your transmitter and receiver batteries the night before you go flying and at other times as recommended by the radio manufacturer.

NOTE: Checking the condition of your receiver battery pack is **highly recommended**. All battery packs, whether it's a trusty pack you've just taken out of another model, or a new battery pack you just purchased, should be cycled, noting the discharge capacity. Oftentimes, a weak battery pack can be identified (and a valuable model saved!) by comparing its actual capacity to its rated capacity. Refer to the instructions and recommendations that come with your cycler. If you don't own a battery cycler, perhaps you can have a friend cycle your pack and note the capacity for you.

Balance Propellers



Carefully balance your propeller and spare propellers before you fly. An unbalanced prop can be the single most significant cause of vibration that can damage your model. Not only will engine mounting screws and bolts loosen, possibly with disastrous effect, but vibration may also damage your radio receiver and battery. Vibration can also cause your fuel to foam, which will, in turn, cause your engine to run hot or quit.

We use a Top Flite Precision Magnetic Prop Balancer™ (TOPQ5700) in the workshop and keep a Great Planes Fingertip Prop Balancer (GPMQ5000) in our flight box.

Ground Check

If the engine is new, follow the engine manufacturer's instructions to break-in the engine. After break-in, confirm that the engine idles reliably, transitions smoothly and rapidly to full power and maintains full power indefinitely. After you run the engine on the model, inspect the model closely to make sure all screws remained tight, the hinges are secure, the prop is secure and all pushrods and connectors are secure.

Range Check

Ground check the operational range of your radio before the first flight of the day. With the transmitter antenna collapsed and the receiver and transmitter on, you should be able to walk at least 100 feet away from the model and still have control. Have an assistant stand by your model and, while you work the controls, tell you what the control surfaces are doing. Repeat this test **with the engine running** at various speeds with an assistant holding the model, using hand signals to show you what is happening. If the control surfaces do not respond correctly, **do not fly!** Find and correct the problem first. Look for loose servo connections or broken wires, corroded wires on old servo connectors, poor solder joints in your battery pack or a defective cell, or a damaged receiver crystal from a previous crash.

ENGINE SAFETY PRECAUTIONS

Failure to follow these safety precautions may result in severe injury to yourself and others.

Keep all engine fuel in a safe place, away from high heat, sparks or flames, as fuel is very flammable. Do not smoke near the engine or fuel; and remember that engine exhaust gives off a great deal of deadly carbon monoxide. Therefore **do not run the engine in a closed room or garage.**

Get help from an experienced pilot when learning to operate engines.

Use safety glasses when starting or running engines.

Do not run the engine in an area of loose gravel or sand; the propeller may throw such material in your face or eyes.

Keep your face and body as well as all spectators away from the plane of rotation of the propeller as you start and run the engine.

Keep these items away from the prop: loose clothing, shirt sleeves, ties, scarfs, long hair or loose objects such as pencils or screwdrivers that may fall out of shirt or jacket pockets into the prop.

Use a "chicken stick" or electric starter to start the engine. Do not use your fingers to flip the propeller. Make certain the glow plug clip or connector is secure so that it will not pop off or otherwise get into the running propeller.

Make all engine adjustments from behind the rotating propeller.

The engine gets hot! Do not touch it during or right after operation. Make sure fuel lines are in good condition so fuel will not leak onto a hot engine, causing a fire.

To stop a glow engine, cut off the fuel supply by closing off the fuel line or following the engine manufacturer's recommendations. Do not use hands, fingers or any other body part to try to stop the engine. Do not throw anything into the propeller of a running engine.

AMA SAFETY CODE (EXCERPT)

Read and abide by the following Academy of Model Aeronautics Official Safety Code:

General

1. I will not fly my model aircraft in sanctioned events, air shows, or model flying demonstrations until it has been proven to be airworthy by having been previously successfully flight tested.

2. I will not fly my model aircraft higher than approximately 400 feet within 3 miles of an airport without notifying the airport operator. I will give right of way to and avoid flying in the proximity of full scale aircraft. Where necessary an observer shall be used to supervise flying to avoid having models fly in the proximity of full scale aircraft.

3. Where established, I will abide by the safety rules for the flying site I use and I will not willfully and deliberately fly my models in a careless, reckless and/or dangerous manner.

7. I will not fly my model unless it is identified with my name and address or AMA number, on or in the model.

9. I will not operate models with pyrotechnics (any device that explodes, burns, or propels a projectile of any kind).

Radio Control

1. I will have completed a successful radio equipment ground check before the first flight of a new or repaired model.

2. I will not fly my model aircraft in the presence of spectators until I become a qualified flier, unless assisted by an experienced helper.

3. I will perform my initial turn after takeoff away from the pit or spectator areas and I will not thereafter fly over pit or spectator areas, unless beyond my control.

4. I will operate my model using only radio control frequencies currently allowed by the Federal Communications Commission.

End Excerpt

CHECK LIST

During the last few moments of preparation your mind may be elsewhere anticipating the excitement of the first flight. Because of this, you may be more likely to overlook certain checks and procedures that should be performed before the model is flown. To help avoid this, a checklist is provided to make sure these important areas are not overlooked. Many are covered in the instruction manual, so where appropriate, refer to the manual for complete instructions. Be sure to check the items off as they are completed (that's why it's called a *check list!*).

1. Fuelproof all areas exposed to fuel or exhaust residue such as the cowl ring, cowl mounting blocks, wing saddle area, etc.

2. Check the C.G. according to the measurements provided in the manual.

3. Be certain the battery and receiver are securely mounted in the fuse. Simply stuffing them into place with foam rubber is not sufficient.

4. Extend your receiver antenna and make sure it has a strain relief inside the fuselage to keep tension off the solder joint inside the receiver.

5. Balance your model laterally as explained in the instructions.

6. Use threadlocking compound to secure critical fasteners such as the set screws that hold the wheel axles to the struts, screws that hold the carburetor arm (if applicable), screw-lock pushrod connectors, etc.

7. Add a drop of oil to the axles so the wheels will turn freely.

8. Make sure all hinges are **securely** glued in place.

9. Reinforce holes for wood screws with thin CA where appropriate (servo mounting screws, cowl mounting screws, etc.).

10. Confirm that all controls operate in the correct direction and the throws are set up according to the manual.

11. Make sure there are silicone retainers on all the clevises and that all servo arms are secured to the servos with the screws included with your radio.

12. Secure connections between servo wires and Y-connectors or servo extensions and the connection between your battery pack and the on/off switch with vinyl tape, heat shrink tubing or special clips suitable for that purpose.

13. Make sure any servo extension cords you may have used do not interfere with other systems (servo arms, pushrods, etc.).

14. Secure the pressure tap (if used) to the muffler with high temp RTV silicone, thread locking compound or J.B. Weld.

15. Make sure the fuel lines are connected and are not kinked.

16. Balance your propeller (and spare propellers).

17. Tighten the propeller nut and spinner.

18. Place your name, address, AMA number and telephone number on or inside your model.

19. Cycle your receiver battery pack (if necessary) and make sure it is fully charged.

20. If you wish to photograph your model, do so before your first flight.

21. Range check your radio when you get to the flying field.

FLYING

The Gee Bee is a great-flying model that flies smoothly and predictably. The Gee Bee does not, however, possess the self-recovery characteristics of a primary R/C trainer and should be flown only by experienced R/C pilots.

Fuel Mixture Adjustments

A fully cowled engine may run at a higher temperature than an un-cowled engine. For this reason, the fuel mixture should be richened so the engine runs at about 200 rpm below peak speed. By running the engine slightly rich, you will help prevent dead-stick landings caused by overheating.

CAUTION: (THIS APPLIES TO ALL R/C AIRPLANES): If, while flying, you notice any unusual sounds, such as a low-pitched “buzz,” this may indicate control surface *flutter*. Because flutter can quickly destroy components of your airplane, any time you detect flutter you must **immediately** cut the throttle and land the airplane! Check all servo grommets for deterioration (this may indicate which surface fluttered) and make sure all pushrod linkages are secure and free of play. If the control surface fluttered once, it probably will flutter again under similar circumstances unless you can eliminate the free-play or flexing in the linkages. Here are some things which can cause flutter: Excessive hinge gap; Not mounting control horns solidly; Poor fit of clevis pin in horn; Side-play of pushrod in guide tube caused by tight bends; Poor fit of Z-bend in servo arm; Insufficient glue used when gluing in the elevator joiner wire; Excessive *play* or *backlash* in servo gears; and insecure servo mounting.

Takeoff

This is a Gee Bee and the Gee Bee has had a reputation for being a difficult airplane to fly but we have designed many of the bad flight characteristics out of the model. By no means is it a trainer but it is also not extremely difficult to fly. Before you get ready to take off, see how the model handles on the ground by doing a few practice runs at **low speeds** on the runway. Hold “up” elevator to keep the tailwheel on the ground. If necessary, adjust the tailwheel so the model will roll straight down the runway. If you are a little apprehensive before the maiden flight, shut the engine down and bring the model back into the pits. Top off the fuel, then check all fasteners and control linkages for peace of mind.

Remember to take off into the wind. In fact, we **do not** recommend that you try to take off or land in a crosswind. The large fuselage and short coupling of the Gee Bee is not well suited to crosswind conditions. We have flown our prototypes in crosswind conditions and found that a wide, long runway is needed for success. If you have a crosswind for your first few flights you may want to consider waiting for better conditions before flying. When you're ready, point the model straight down the runway, into the wind, hold a bit of up elevator to keep the tail on the ground to maintain tailwheel steering, and then gradually advance the throttle. Gradually advancing the throttle is important because with the short fuselage, if you advance it too quickly, torque from the motor can become strong. As the model gains speed decrease up elevator, allowing the tail to come off the ground. One of the most important things to remember with a tail dragger is to always be ready to apply **right** rudder to counteract engine torque. Gain as much speed as your runway and flying site will practically allow before gently applying up elevator, lifting the model into the air. At this moment it is likely that you will need to apply more right rudder to counteract engine torque. Be smooth on the elevator stick, allowing the model to establish a **gentle** climb to a safe altitude before turning into the traffic pattern.

Flight

For reassurance and to keep an eye on other traffic, it is a good idea to have an assistant on the flight line with you. Tell him to remind you to throttle back once the plane gets to a comfortable altitude. While full throttle is usually desirable for takeoff, most models fly more smoothly at reduced speeds.

Take it easy with the Gee Bee for the first few flights, gradually getting acquainted with it as you gain confidence. Adjust the trims to maintain straight and level flight. After flying around for a while and while still at a safe altitude with plenty of fuel, practice slow flight and execute practice landing approaches by reducing the throttle to see how the model handles at slower speeds. Add power to see how she climbs as well. Continue to fly around, executing various maneuvers and making mental notes (or having your assistant write them down) of what trim or C.G. changes may be required to fine tune the model so it flies the way you like. Mind your fuel level, but use this first flight to become familiar with your model before landing.

Aerobatics

Once you have a feel for how the Gee Bee flies you are probably going to want to try some aerobatics and the Gee Bee does them quite well. With the O.S.®1.20 we were able to do large vertical loops, hammerheads and the split ess. The plane flies very well inverted, does nice rolls and point rolls but the most impressive maneuver is the knife edge! With a bit of rudder input this plane will knife-edge across the sky all day long. As you know the Gee Bee was a racer and true to racing form, the Gee Bee is great for straight flight into pylon turns. You should be very happy with the aerobatic capabilities the Gee Bee has to offer!

Engine Out Situation

It was mentioned earlier that you should install a reliable running engine. No matter how good your engine is, the inevitable “dead stick landing” will probably occur. When flying without power the Gee Bee will handle just fine as long as you keep the speed up. Do not get too slow with the power off! We have found that without power the plane slows very quickly due to the large frontal area of the plane. When the plane slows too much a stall follows. Without altitude you may not have recovery room. Don't try to stretch your landings. Should the engine quit, keep the nose down, maintain airspeed and land immediately.

Landing

Landing the Gee Bee is probably a bit more difficult than the take-off or the flying. Concentration on the landings for the first few flights will help you learn the best way for you to land the Gee Bee. To initiate a landing approach, lower the throttle

while on the downwind leg. Allow the nose of the model to pitch downward to gradually bleed off altitude. Continue to lose altitude, but maintain airspeed by keeping the nose down as you turn onto the crosswind leg. Make your final turn toward the runway (into the wind, just like you did for your takeoff) keeping the nose down to maintain airspeed and control. Level the attitude when the model reaches the runway threshold, modulating the throttle as necessary to maintain your glide path and airspeed. If you are going to overshoot, smoothly advance the throttle (always ready on the right rudder to counteract torque) and climb out to make another attempt. When you're ready to make your landing, flare when the model is a foot or so off the deck; smoothly increase up elevator until it gently touches down. Once the model is on the runway and has lost flying speed, hold up elevator to place the tail on the ground, regaining tailwheel control. You can also land the Gee Bee on the main wheels and execute a slightly longer roll out with the tail off of the ground. From our experience we have found it takes a bit more practice to achieve a nicely flared, three-point landing than it does to land the Gee Bee on its wheels.

One final note about flying your model. Have a goal or flight plan in mind for **every** flight. This can be learning a new maneuver(s), improving a maneuver(s) you already know, or learning how the model behaves in certain conditions (such as on high or low rates). This is not necessarily to improve your skills (*though it is never a bad idea!*), but more importantly so you do not surprise yourself by impulsively attempting a maneuver and suddenly finding that you've run out of time, altitude or airspeed. Every maneuver should be deliberate, not impulsive. For example, if you're going to do a loop, check your altitude, mind the wind direction (anticipating rudder corrections that will be required to maintain heading), remember to throttle back at the top and make certain you are on the desired rates (high/low rates). A flight plan greatly reduces the chances of crashing your model just because of poor planning and impulsive moves. **Remember to think.**

Have a ball!

But always stay in control and fly in a safe manner.

GOOD LUCK AND GREAT FLYING!

OTHER ITEMS AVAILABLE FROM GREAT PLANES

O.S.® Engines .91 FX Ringed Engine w/Muffler



Displacement: 0.912 cu in (14.95cc)
 Bore: 1.090 in (27.7mm)
 Stroke: 0.976 in (24.8mm)
 Practical RPM: 2,000-16,000
 Output: 2.8 bhp @ 15,000 rpm
 Weight: 19.3 oz (550g)
 Includes: Muffler, glow plug & safety propeller locknut assembly
 Requires: fuel, mount & prop

Features dual ball bearings for durability and smooth operation. Its low crankcase profile allows for a taller, semi-squared head with increased cooling fin area. The remote needle valve offers protection and has coarse threads that hold settings securely. Comes with 2-year warranty and muffler with built-in pressure tap. OSMG0591

O.S.® Engines FS-120S-E Surpass™ Engine w/o Pump



Bore: 1.22 in (30.4mm)
 Stroke: 1.08 in (27.5mm)
 Power Output: 1.9 bhp @ 11,000 rpm
 Weight (w/o muffler): 30.5 oz (865g)
 Weight (w/muffler): 31.17 oz (884g)
 Practical rpm range: 2,000-11,000
 Suggested Props: 13x11, 13x12, 14x10, 14x11,
 15x8, 16x6, 16x7, 17x6

Enjoy the greater realism, torque and fuel economy of 4-stroke power with the FS-120S-E from O.S. This ringed piston engine features a ball bearing-supported camshaft and crankshaft and rear-mounted updraft carburetor with built-in pressure regulator. Includes #F glow plug, exhaust header and muffler, and 2-year warranty protection. OSMG0930

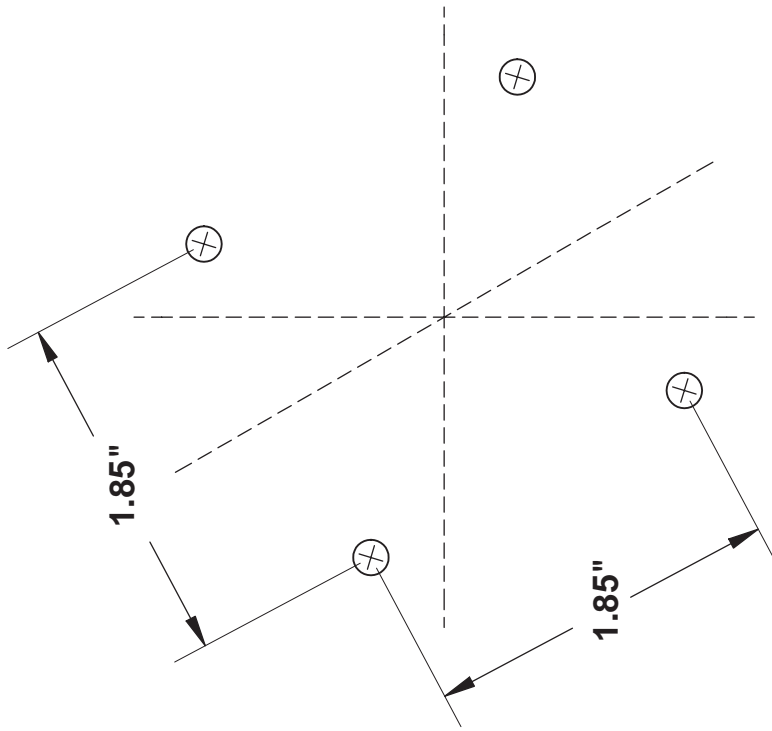

**EM6012 BOLT TEMPLATE FOR THE
O.S. .91 2-STROKE ENGINE**
IT WILL USE 8-32 BOLTS AND BLIND NUTS
IN A TYPICAL INSTALLATION

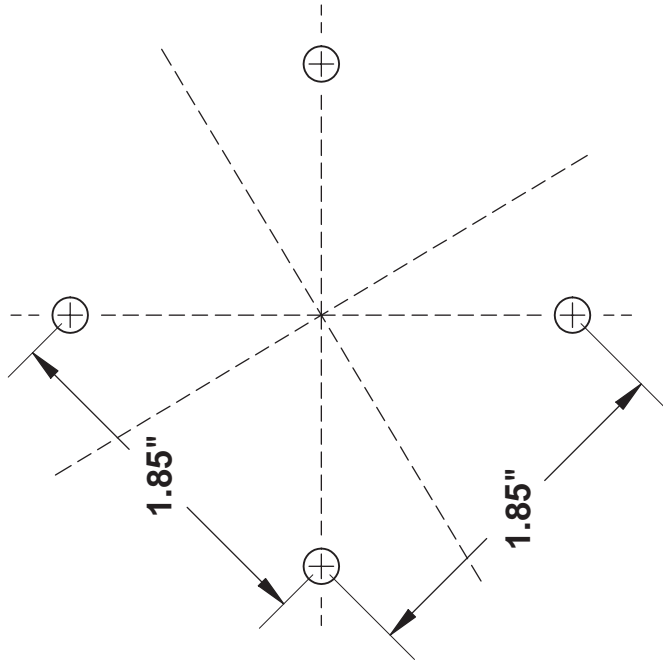

**EM6012 BOLT TEMPLATE FOR THE
O.S. 1.20 4-STROKE ENGINE**
IT WILL USE 8-32 BOLTS AND BLIND NUTS
IN A TYPICAL INSTALLATION