

MATT CHAPMAN CAP 580

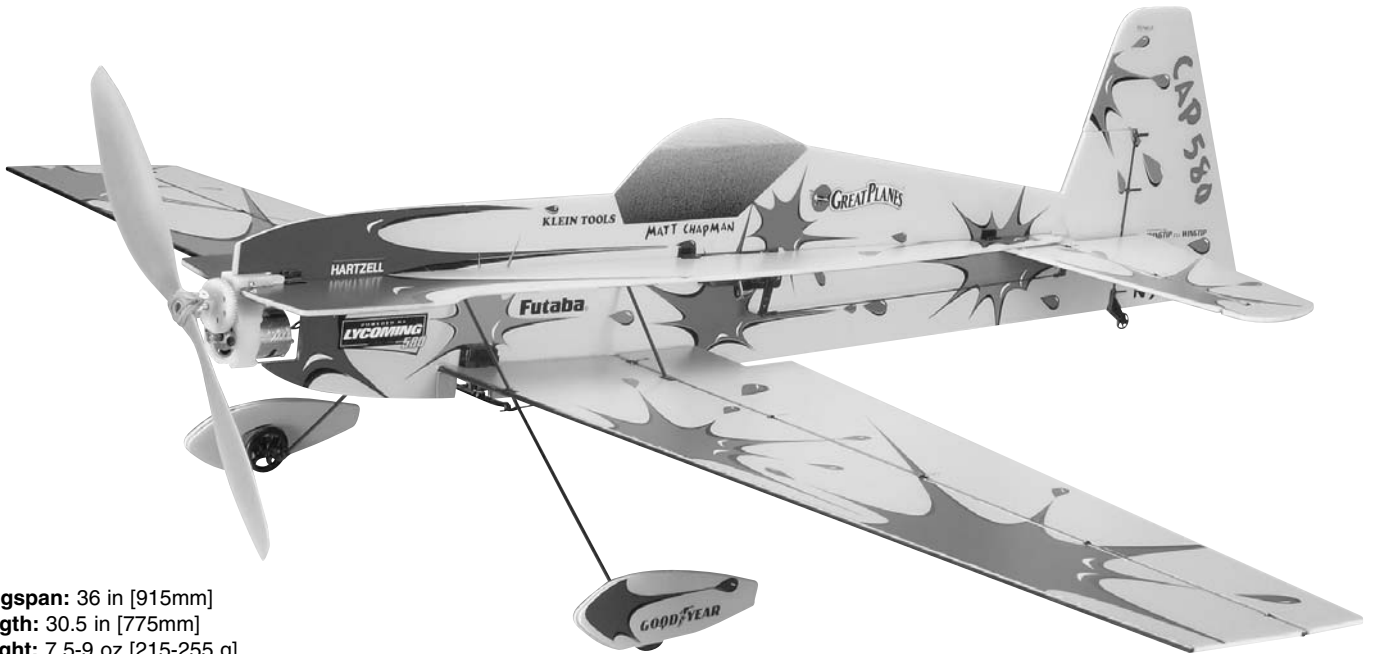

INSTRUCTION MANUAL



Wingspan: 36 in [915mm]

Length: 30.5 in [775mm]

Weight: 7.5-9 oz [215-255 g]

Wing Area: 222 sq in [14.4 dm²]

Wing Loading: 5-6 oz/sq ft [15-18 g/dm²]

Radio: 4-channel w/3 micro servos and 10-Amp ESC

Power System: Included ElectrifiFly T-370 ferrite motor with gearbox, or optional direct-drive RimFire Brushless motor.

WARRANTY

Great Planes® Model Manufacturing Co. guarantees this kit to be free from defects in both material and workmanship at the date of purchase. This warranty does not cover any component parts damaged by use or modification. **In no case shall Great Planes' liability exceed the original cost of the purchased kit.** Further, Great Planes reserves the right to change or modify this warranty without notice.

In that Great Planes has no control over the final assembly or material used for final assembly, no liability shall be assumed nor accepted for any damage resulting from the use by the user of the final user-assembled product. By the act of using the user-assembled product, the user accepts all resulting liability.

If the buyer is not prepared to accept the liability associated with the use of this product, the buyer is advised to return this kit immediately in new and unused condition to the place of purchase.

To make a warranty claim send the defective part or item to Hobby Services at the address below:

Hobby Services
3002 N. Apollo Dr. Suite 1
Champaign IL 61822 USA

Include a letter stating your name, return shipping address, as much contact information as possible (daytime telephone number, fax number, e-mail address), a detailed description of the problem and a photocopy of the purchase receipt. Upon receipt of the package the problem will be evaluated as quickly as possible.

READ THROUGH THIS MANUAL BEFORE STARTING CONSTRUCTION. IT CONTAINS IMPORTANT WARNINGS AND INSTRUCTIONS CONCERNING THE ASSEMBLY AND USE OF THIS MODEL.



Champaign, Illinois
(217) 398-8970, Ext 5
airsupport@greatplanes.com

TABLE OF CONTENTS

INTRODUCTION	2
SAFETY PRECAUTIONS	2
DECISIONS YOU MUST MAKE	3
Transmitter	3
Servos	3
Receiver	3
Battery	4
Speed Control	4
Charger	4
Battery Charger Leads	4
Optional: Brushless Motor Upgrade	4
Propeller Selection	4
Glue	4
ADDITIONAL ITEMS REQUIRED	4
KIT CONTENTS	5
KIT INSPECTION	6
ORDERING REPLACEMENT PARTS	6
BUILD THE AIRPLANE	7
Assemble the Horizontal Tail	7
Assemble the Fuselage	9
Assemble the Wing	11
Final Airframe Assembly	11
Finish the Landing Gear	12
Radio Setup	13
Mount the Motor and Gearbox	15
Firewall Mounted System	17
GET THE MODEL READY TO FLY	18
Check the Control Directions	18
Set the Control Throws	18
Balance the Model (C.G.)	19
Balance the Model Laterally	19
PREFLIGHT	19
Identify Your Model	19
Charge the Batteries	19
Range Check	20
MOTOR SAFETY PRECAUTIONS	20
AMA SAFETY CODE (EXCERPTS)	20
General	20
Radio Control	20
CHECK LIST	21
FLYING	21
Hand Launch	21
Rise-Off-Ground Takeoffs	21
Flight	21
Landing	21
CONTROL THROW TEMPLATES	Back Cover

INTRODUCTION

The FlatOut CAP 580 is an excellent way to enjoy 3-D aerobatics without the cost and headaches of giant-scale gasoline-powered models. A couple of hours on the workbench, and your CAP will be ready to tackle torque rolls, walls, harriers, high-alpha rolling circles and more! An excellent indoor or calm-day outdoor performer, this airplane is a virtually unlimited 3-D aerobat, but flying it involves only connecting the battery, throttling up, and letting go!

Take care to build straight and true. Misaligned parts will hurt the airplane's ability to perform the extreme aerobatics it is designed for.

For the latest technical updates or manual corrections to the FlatOut CAP 580, visit the Great Planes web site at www.greatplanes.com. Open the "Airplanes" link, then select the FlatOut CAP 580 ARF. If there is new technical information or changes to this model, a "tech notice" box will appear in the upper left corner of the page.

CAUTION: Be aware that the FlatOut CAP 580 is operated on the same frequency band as larger, "regular" R/C models. If flying your CAP within five miles of an R/C site, there is a real possibility that you could be operating your model on the same frequency (channel) as another R/C pilot. If this happens a crash will result-with the person flying the more expensive model suffering the greater loss (and having greater potential for property damage or injury). The best thing to do is to join an R/C club and fly at the site where frequency control measures will be in effect. If you insist on flying elsewhere **always be aware of your proximity to R/C flying sites.**

A NOTE ABOUT METRIC DIMENSIONS

Since the parts of this airplane have been designed with metric dimensions, the metric size (in millimeters) of the parts is listed first in the text. For convenience, we have listed close approximations of these sizes in the English system (inches), but be aware that these conversions are only approximate.

PROTECT YOUR MODEL, YOURSELF & OTHERS...FOLLOW THESE IMPORTANT SAFETY PRECAUTIONS



Attention: The product you have purchased is powered by a rechargeable battery. At the end of its useful life, under various state and local laws, it may be illegal to dispose of this battery into the municipal waste system. Check with your local solid waste officials for details in your area for recycling options or proper disposal.

This product contains a chemical known to the state of California to cause cancer and birth defects or other reproductive harm.

1. Even though the FlatOut CAP 580 is small, lightweight and flies slowly, if it is not assembled and operated correctly it could possibly cause injury to yourself or spectators and damage property.

2. Build the plane according to the instructions. Do not alter or modify the model, as doing so may result in an unsafe or unflyable model.

3. Use an R/C radio system and components that are in first-class condition. The FlatOut CAP requires specialized radio gear. Refer to **DECISIONS YOU MUST MAKE** to get an accurate description of the specialized gear required.

4. You must properly install all R/C and other components so that the model operates correctly on the ground and in the air.

5. You **must** test the operation of the model before every flight to insure that all equipment is operating, and that the model has remained structurally sound. Be sure to check connectors often and replace them if they show signs of wear or fatigue.

Note: We, as the kit manufacturer, provide you with a top quality kit and great instructions, but ultimately the quality and flyability of your finished model depends on how you build it; therefore, we cannot in any way guarantee the performance of your completed model, and no representations are expressed or implied as to the performance or safety of your completed model.

Remember: Take your time and follow directions to end up with a well-built model that is straight and true.

If you're not already an **AMA** (Academy of Model Aeronautics) member, we highly recommend that you join. In addition to providing liability protection while operating under the AMA Safety Code, the AMA is the governing body of model aeronautics in the United States and fights for your rights as member of the modeling community. You must also be an AMA member to fly at R/C clubs chartered by the AMA-most of which are. Contact the AMA at the address or toll-free phone number below.



Academy of Model Aeronautics
5151 East Memorial Drive
Muncie, IN 47302-9252
Tele. (800) 435-9262
Fax (765) 741-0057

Or via the Internet at: <http://www.modelaircraft.org>

DECISIONS YOU MUST MAKE

In the hands of a capable pilot the FlatOut CAP 580 is an impressive 3-D performer. But for the CAP to perform to its full potential, it must be properly equipped with all the right gear (servos, batteries, receiver, speed control). There may be more than one type and brand of radio equipment that can be used, but based on extensive testing, following is the equipment we recommend so you can get the most performance out of your CAP and assemble it as shown in this instruction manual.

Transmitter

With a standard, four-channel radio, the FlatOut CAP 580 is capable of all the basic 3-D maneuvers. However, some advanced pilots who are already familiar with handling "flat foamies" may prefer to fly the CAP 580 with a computer radio capable of endpoint adjustments (for fine-tuning control throws), exponentials (for "softening" the throws near the center of the travel), and various mixing functions (such as rudder-to-elevator mixing for extended knife-edge flight).

Servos

The FlatOut CAP 580 requires three *sub-micro* servos with a maximum weight of .3 oz [9g] each and a minimum torque rating of 15 oz-in. Futaba® S-3108M (micro connector) servos (FUTM0700) are ideal because they meet the torque and weight requirements and have a micro connector that is compatible with the Futaba *Ultra Micro* receiver. Although there may be other servos that will physically fit in the model, those outside the recommended weight and torque specifications will adversely affect flight performance and are not recommended. **Note:** During assembly when it's time to mount the servos, you will be instructed to glue them in. Do not be alarmed as this is a common practice with this type of lightweight, high-performance model. Should servo removal ever be necessary for repair, replacement or transfer to another model, this can be done by prying them out with a hobby knife or a small screwdriver.

Receiver

The lightest four-channel receiver is recommended and must be compatible with whatever servos will be used (not all servos are compatible with all receivers-even servos and receivers within the same brand). The Futaba R-124F *Ultra Micro* receiver is recommended and is compatible with the 3108M servos recommended. **Note:** Futaba receivers are sold on high and low bands and come without crystals. Following are the order numbers for the R-124F receiver and compatible crystals:

	Low Band (Channels 11-35)	High Band (Channels 36-60)
R124F Receiver Crystal	FUTL0438 FUTL62**	FUTL0439 FUTL63**

Replace the “” in the order number for the crystals with the preferred channel number. For example, if you want to fly on channel 33, order a low band receiver and crystal number FUTL6233.

Battery

The FlatOut CAP 580 requires a 3-cell (11.1V), 350-700mAh lithium-polymer (LiPo) battery capable of providing 7A continuous discharge current. For long flight times and good performance, we recommend the Electrifiy 3-cell, *3-Series* 640mAh battery pack (GPMP0805). For minimum weight, at the expense of some flight time, the Electrifiy 3-cell, *3-Series* 350mAh battery pack (GPMP0801) works well. **Note:** The Electrifiy 700mAh battery is not recommended for this model as it is not capable of delivering the current required by this system. For optimum performance battery weight should not exceed 2.3 oz. [65g].

Speed Control

An electronic speed control capable of handling a minimum of 7A continuous current is required. Additionally, the speed control should be as light as possible. The Electrifiy C-10 Micro High-Frequency ESC w/BEC (GPMM2010) is suitable. If upgrading to the optional brushless motor system recommended (below), a speed control intended for brushless motors (a brushless speed control) capable of at least 8A continuous current such as the Electrifiy BL-8 (GPMM2070) must be used. **NEVER use speed controllers intended for brushed motors on brushless motors (and vice-versa).**

Charger

A charger capable of charging 3-cell (11.1V) LiPo batteries such as the Electrifiy PolyCharge 1-3-cell LiPo charger (GPMM3010) must be used. If using another charger, it **must** be a LiPo charger or have a LiPo charge mode. Never charge LiPo batteries with chargers not intended for LiPo batteries or chargers on NiMH or NiCd settings. Overcharging or explosion may result. In addition to the PolyCharge, the Electrifiy Triton™ (GPMM3150) or Accu-Cycle Elite™ (HCAP0280) are also suitable chargers.

Battery Charging Leads

Many chargers (including the Triton and Accu-Cycle Elite) do not include charging leads, but rather have banana jacks to plug the leads into. If this is the case with your charger, you will need to purchase a charge lead to match your battery. For the recommended 350 mAh pack, the correct lead is GPMM3105.

Optional: Brushless Motor Upgrade

Rest assured, the FlatOut CAP 580 is capable of 3-D flight with the included Electrifiy “stick-mount” motor and gearbox combination. But for pilots who always insist on upgrading and don’t mind spending a little extra money, the Electrifiy Rimfire 22M-1000 brushless motor (GPMG4500) will provide increased power and flight time while simultaneously reducing weight. Don’t forget, if upgrading to a brushless motor, a “brushless” speed controller such as the Electrifiy BL-8 8-Amp ESC (GPMM2070) must be used. This kit also includes the firewall and instructions for mounting a brushless motor.

Propeller Selection

A 10 x 3.8 propeller is included in this kit, and this propeller offers the best performance with the included motor system. If you are upgrading to the RimFire brushless motor, a 9 x 3.8 propeller is recommended.

Glue

Though there may be a few different types of adhesives that the FlatOut CAP could be assembled with, we have had the best success with, and exclusively recommend foam-safe CA.

- 1 oz. Great Planes Foam Safe CA Medium (GPMR6069)
- 2 oz. Great Planes Foam Safe CA Medium (GPMR6070)
- 1 oz. Great Planes Foam Safe CA Thick (GPMR6072)
- 2 oz. Great Planes Foam Safe CA Thick (GPMR6073)

Regular CA is not recommended as it will aggressively attack the foam used in this model. In addition to being foam-compatible, foam-safe CA is also suitable for gluing together all of the rest of the materials (balsa, carbon) included in this kit. No other adhesive is required to build the FlatOut CAP 580.

ADDITIONAL ITEMS REQUIRED

In addition to common household tools and hobby tools, this is the “short list” of the most important items required to build the FlatOut CAP 580.

- Great Planes Aerosol Activator (GPMR6034)
- Hobbico® CA Applicator tips (HCAR3780)
- Hobby knife with #11 blade (HCAR0100)
- #11 blades (HCAR0211)
- Metric ruler (for identifying tubes and rods)
- 5.5" Easy Touch™ sanding block (GPMR6169) with 220-grit sandpaper (GPMR6185)
- 2.5mm or 3/32" drill bit
- 1.5mm drill bit or 1/16" drill bit
- Double-sided foam tape (GPMQ4400)
- Clear tape
- Great Planes Plan Protector (GPMR6167)

KIT CONTENTS

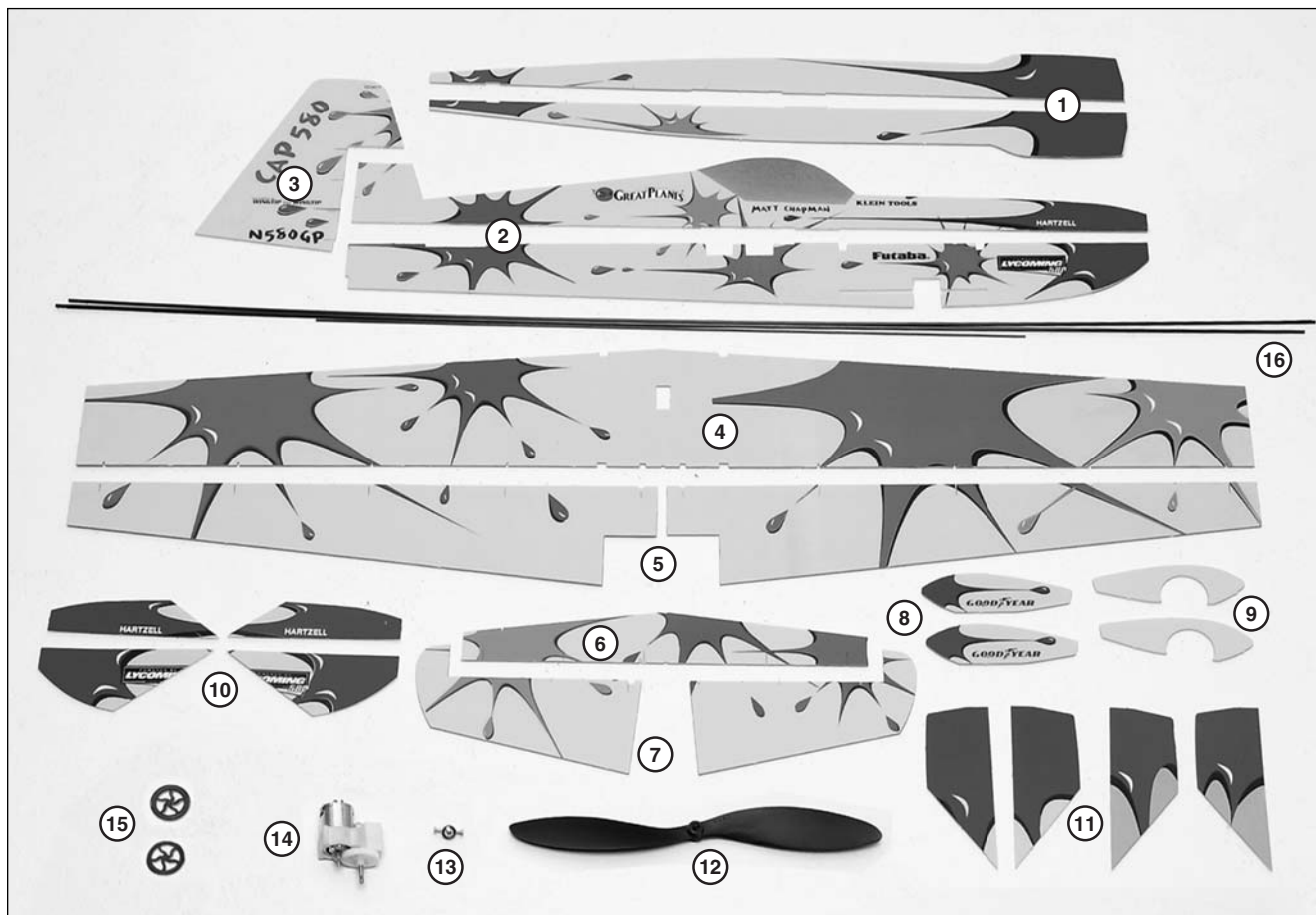

Kit Contents (Photographed)

- | | |
|--|--|
| <ul style="list-style-type: none"> 1 Horizontal Fuselage Halves (2) 2 Vertical Fuselage Halves (2) 3 Rudder 4 Wing 5 Ailerons (2) 6 Horizontal Stabilizer 7 Elevator Halves (2) 8 Outer Wheel Pants (2) 9 Inner Wheel Pants (2) 10 (Brushless Only) Vertical Fuselage Doublers (4) 11 (Brushless Only) Horizontal Fuselage Doublers (4) 12 Propeller 13 Prop Saver 14 Motor/Gearbox Assembly | <ul style="list-style-type: none"> 15 Main Wheels (2) 16 Carbon Rods and Tubes: <ul style="list-style-type: none"> Fuse Doubler Tube 5.5x250mm [7/32" x 9-7/8"] Elevator Joiner Tube 3x305mm [1/8" x 12"] Rudder Post Tube 3x108mm [1/8" x 4-1/4"] Fuselage Tube 3x649mm [1/8" x 25-1/2"] Leading Edge Tube 3x458mm [1/8" x 18"] (2) Trailing Edge Tube 3x914mm [1/8" x 36"] Landing Gear Legs 2x190mm [5/64" x 7-1/2"] (2) Rear Wing Braces 2x71mm [5/64" x 2-3/4"] (2) Wheel Axles 2x17mm [5/64" x 5/8"] (2) Rudder Pushrod 1x325mm [.040" x 12-3/4"] Elevator Pushrod 1x290mm [.040" x 11-1/2"] Aileron Pushrods 1x80mm [.040" x 3-1/8"] (2) |
|--|--|

Kit Contents (Not Photographed)

- | | | |
|---|---|--|
| <ul style="list-style-type: none"> 3mm Plywood Firewall Hook & Loop Mounting Material O-Rings (2) Gearbox Motor Block | <p>Plastic Tree Parts:</p> <ul style="list-style-type: none"> A1 Z-Bend Clevis (10) A2 Offset Z-Bend Clevis (4) B1 Stand-Alone Control Horn (5) B2 Stand-Alone Control Horn Retainer (5) C1 Clip Hinge Control Horn (5) C2 Clip Hinge (26) | <ul style="list-style-type: none"> C3 Hinge Retainer Ring (10) C4 Aileron Link Horn (4) D1 Axle Support (2) D2 Rod Support (12) D4 Tailwheel Bracket (1) D5 Tailwheel (1) D6 Wheel Collar (2) E1 Control Surface Brace (4) E2 Fuselage Joiner (3) E3 Pushrod Guides (4) F1 Wire Clip (4) F2 Wing Servo Mount (1) |
|---|---|--|

KIT INSPECTION

Before starting to build, take an inventory of this kit to make sure it is complete, and inspect the parts to make sure they are of acceptable quality. If any parts are missing or are not of acceptable quality, or if you need assistance with assembly, contact **Product Support**. When reporting defective or missing parts, use the part names exactly as they are written in the Kit Contents list.

Great Planes Product Support:
3002 N Apollo Drive, Suite 1
Champaign, IL 61822
Telephone: (217) 398-8970, ext. 5
Fax: (217) 398-7721
E-mail: airsupport@greatplanes.com

ORDERING REPLACEMENT PARTS

Replacement parts for the Great Planes FlatOut CAP 580 ARF are available using the order numbers in the **Replacement Parts List** that follows. The fastest, most economical service can be provided by your hobby dealer or mail-order company.

To locate a hobby dealer, visit the Hobbico web site at **www.hobbico.com**. Choose "Where to Buy" at the bottom of the menu on the left side of the page. Follow the instructions provided on the page to locate a U.S., Canadian or International dealer. If a hobby shop is not available, replacement parts may also be ordered from Tower Hobbies® at www.towerhobbies.com, or by calling toll free (800) 637-6050.

Parts may also be ordered directly from Hobby Services by calling (217) 398-0007, or via facsimile at (217) 398-7721, but full retail prices and shipping and handling charges will

apply. Illinois and Nevada residents will also be charged sales tax. If ordering via fax, include a Visa® or MasterCard® number and expiration date for payment.

Mail parts orders and payments by personal check to:

Hobby Services
 3002 N Apollo Drive, Suite 1
 Champaign IL 61822

Be certain to specify the order number exactly as listed in the Replacement Parts List. Payment by credit card or personal check only; no C.O.D.

If additional assistance is required, contact Product Support by e-mail at **productsupport@greatplanes.com**, or by telephone at (217) 398-8970.

Replacement Parts List

<u>Order Number</u>	<u>Description</u>	<u>How to Purchase</u>
	Missing pieces	Contact Product Support
	Instruction manual.....	Contact Product Support
	Full-size plans	Not available
	Kit parts listed below.....	Hobby Supplier
GPMP0217	Gear Drive Body	
GPMG0860	Prop Shaft and Spur Gear	
GPMG0239	Pinion Gear	
GPMG0312	Replacement Motor	
APCQ5016	10 x 3.8" Propeller	
GPMQ4620	Prop Saver	
GPMA2794.....	Hardware Set	
GPMG0215	Motor/Gear Drive Assembly	
GPMQ4618	Prop Saver O-Ring	

BUILD THE AIRPLANE

Assemble the Horizontal Tail

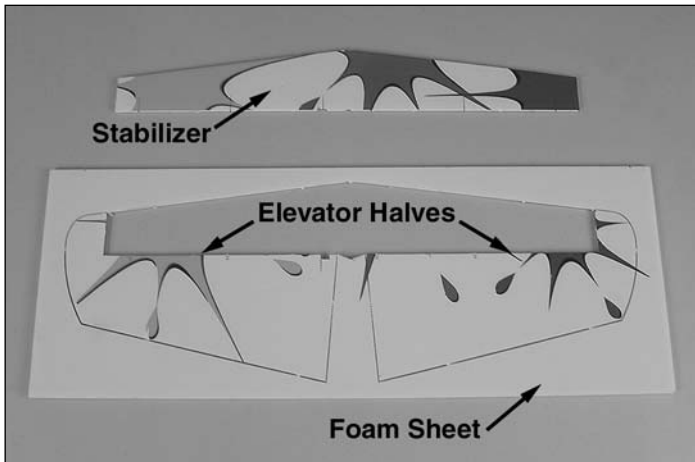

❑ 1. Cut the **stabilizer** free from the foam sheet with a *sharp* #11 hobby knife. **DO NOT** cut the **elevator halves** free at this time.



❑ 2. Following the Expert Tip below, use foam-safe CA and accelerator to glue six C2 **clip hinges** into the stabilizer, using the 3 x 305mm [1/8" x 12"] **elevator joiner tube** as a guide.



HOW TO INSTALL CLIP HINGES

The clip-hinge system provides a precise, free-moving hinge. Install all of the clip hinges on this model following the instructions below.

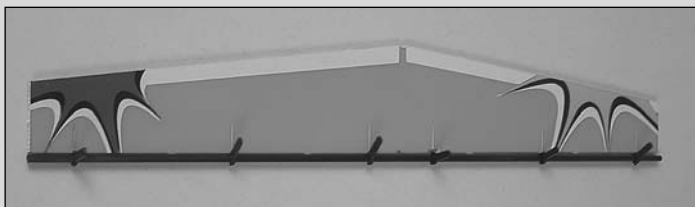

A. Snap all of the hinges onto the carbon rod. Align the hinges with the slots.

B. Coat both sides of one hinge with foam-safe CA where it contacts the sides of the hinge slot. Rotate the hinge down into

the slot. Be certain the top and bottom of the hinge remains flush with the top and bottom of the control surface you are hinging. **IMPORTANT:** Avoid getting any CA on the tube or the arms of the clips. The clips must rotate freely on the tube.

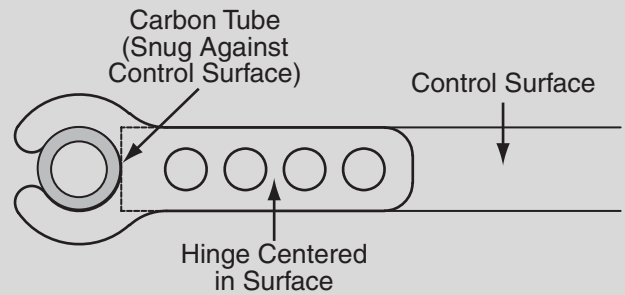

C. One at a time, coat the sides of each hinge and glue them into the slots.



❑ 3. Remove the elevator joiner tube from the hinges.

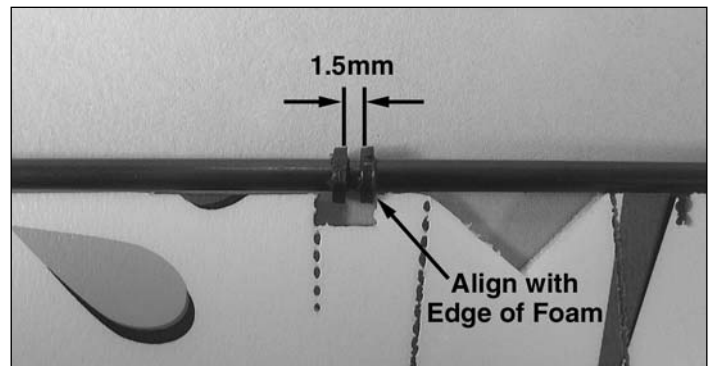

❑ 4. Without removing the elevator halves from the foam sheet, slide two C3 **hinge retainer rings** onto the **elevator joiner tube**. Align the rings with the cutout in the left elevator half. There should be a 1.5mm gap between the two rings. Secure each ring with a drop of glue on the outside of the gap. Avoid getting glue between the rings.

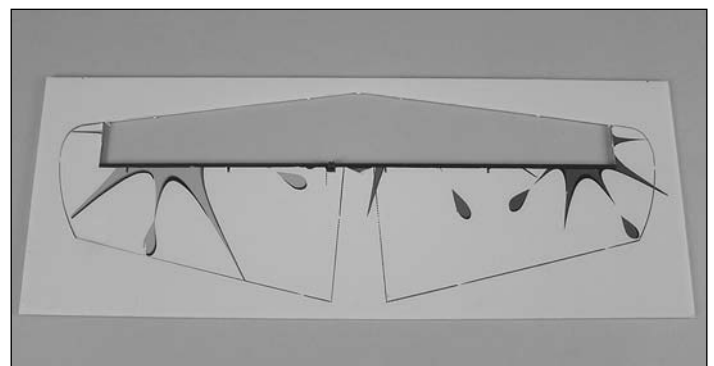

❑ 5. Following the **Expert Tip** below, permanently join the elevator halves by gluing in the elevator joiner tube.



HOW TO GLUE THE TUBES TO THE CONTROL SURFACES

NOTE: You may want to protect your work surface from excess glue. We recommend Great Planes Plan Protector (GPMR6167) for this purpose.

A. Cut several 1-1/2" pieces of tape. Fold the last 1/4" over to make a tab for easy removal.

B. Coat the edge of the foam with foam-safe CA—do not use an excessive amount of glue. **Hint:** A CA applicator tip is recommended to accurately control the bead of glue.

C. Use the tape pieces to hold the tube against the foam edge. Weigh the parts down on a flat surface to prevent warping and allow the glue to cure without accelerator.

D. Once the glue has cured, remove the tape.

6. Cut the elevator halves free of the sheet.



7. Join the elevators to the stab by snapping the clip hinges to the joiner tube.

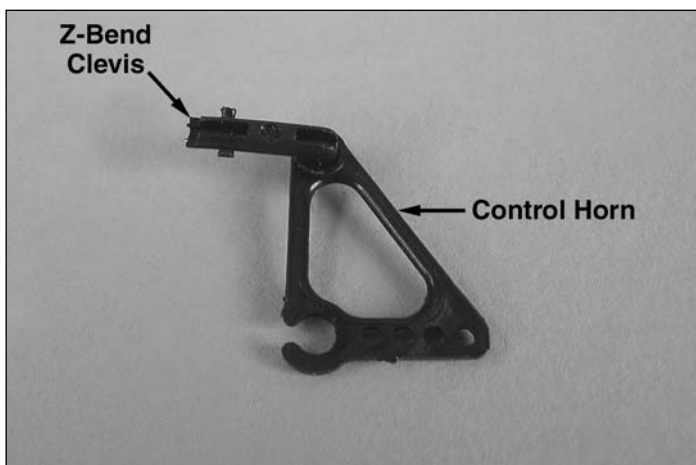

8. Insert an A1 Z-bend clevis into a C1 clip-hinge control horn.



HOW TO MAKE INSTALLING Z-BEND CLEVISES EASIER



A. Using a sharp #11 hobby knife, remove any flashing from the inside of the hole you are installing the Z-bend into. Do this by rotating the blade in the hole while applying gentle pressure. Be careful not to remove too much material—your goal here is to remove small ridges of flashing, not to make the hole bigger.

B. Snap the Z-bend clevis into place.



9. Clip the control horn onto the joiner tube aligned with the precut slot.



10. Coat the gluing area on the control horn with glue and rotate it down into the precut slot.

Assemble the Fuselage

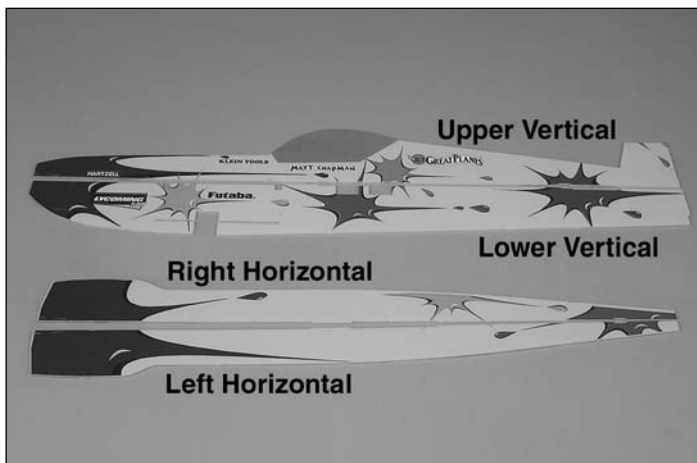

1. Cut the **upper** and **lower vertical fuselage parts** and the **right** and **left horizontal fuselage parts** free from their foam sheets. If using the gearbox included with this kit, or any other type of “stick-mount” gearbox, cut out all four sections from the fuselage parts. If using a firewall-mounted, brushless outrunner motor, cut out only the section from the lower vertical fuselage.

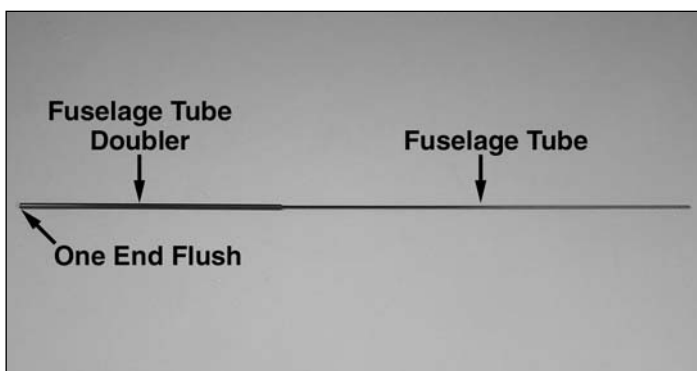

2. Glue the 5.5 x 250mm [7/32" x 9-7/8"] **fuselage tube doubler** over the 3 x 649mm [1/8" x 25-1/2"] **fuselage tube**. One end should be flush. From now on, this assembly will be referred to as the fuselage tube.

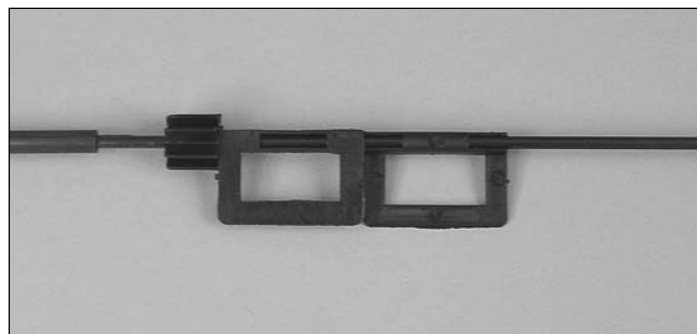
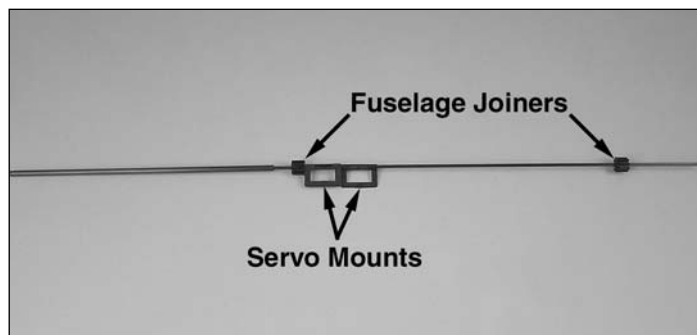

3. Slide an **E2 fuselage joiner**, two **F3 fuselage servo mounts**, and another fuselage joiner onto the fuselage tube. With the tube doubler forward, and the servo mounts hanging down, the front servo mount should have its flat face on the left, and the rear servo mount should have its flat face on the right.

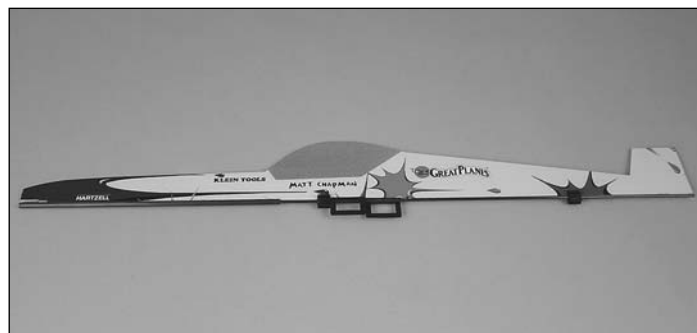

4. Position the servo mounts and fuse joiners so that they align with the precut slots in the upper vertical fuselage.

5. Use glue to attach the fuselage tube to the top half of the vertical fuselage.

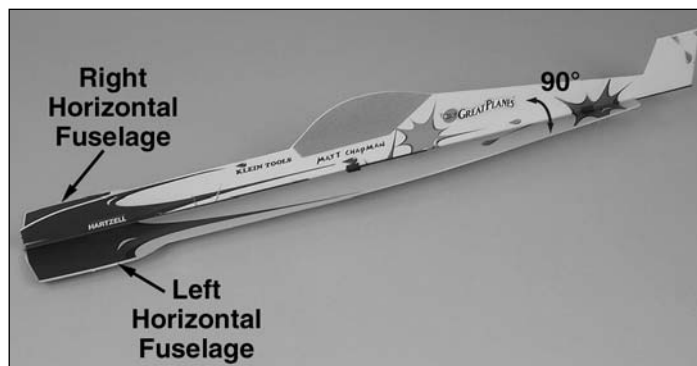

6. Glue the left and right horizontal fuselage halves to the fuselage tube. Make sure they are perpendicular to the vertical fuselage.

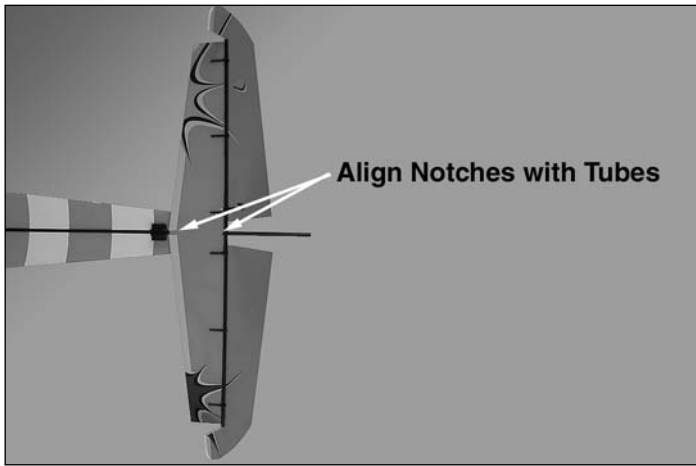

7. Glue the stabilizer into position on the bottom of the horizontal fuselage halves. Use the notches in the LE and TE of the stab to align it with the fuselage tube.

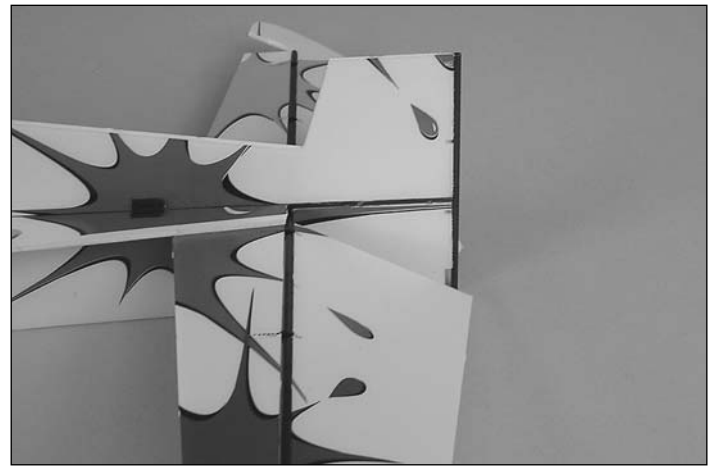

10. Remove the rudder post tube from the rudder. Glue the rudder post tube to the TE of the vertical fin and vertical fuselage halves.

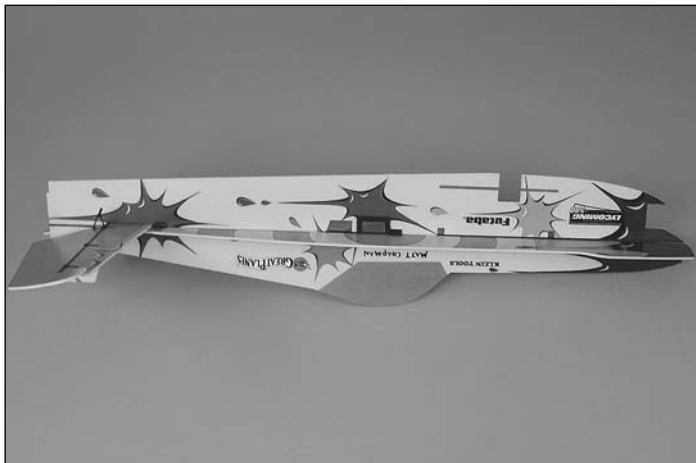

8. Glue the **bottom vertical fuselage half** to the fuselage tube. Make sure to keep it parallel with the top half and perpendicular to the horizontal fuselage. Glue the backs of the servo mounts to the bottom vertical fuselage half.

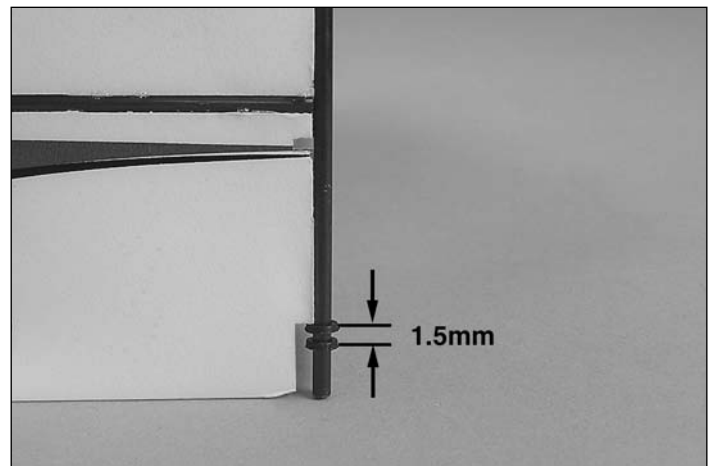

11. Slide two C3 hinge retainer rings onto the bottom of the rudder post. Align the top ring with the point where the foam meets the rudder post tube. Position the bottom ring 1.5mm below the top one. Secure each ring with a drop of glue on the outside of the gap. Avoid getting glue between the rings.



9. Using the technique described in the previous expert tip, glue three C2 clip hinges and a C1 clip hinge control horn to the **rudder**, using the 3 x 108mm [1/8" x 4-1/4"] **rudder post tube** as a guide.

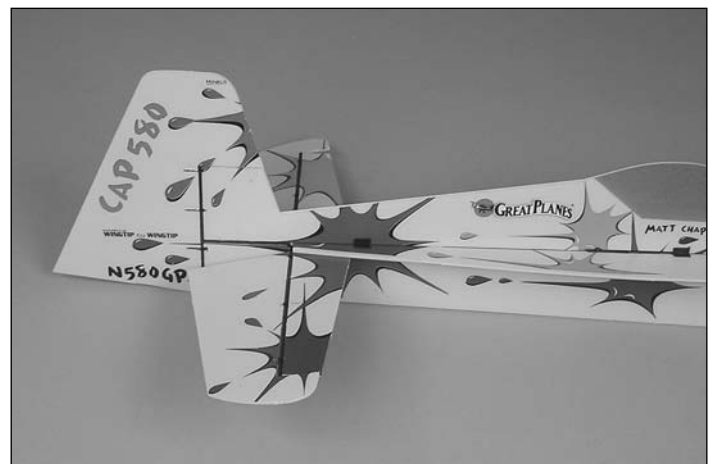

12. Snap the rudder onto the rudder post.

Assemble the Wing

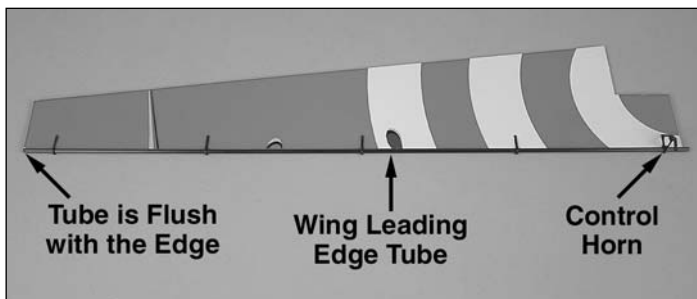

1. Insert A1 Z-bend clevises into opposite sides of two C1 clip-hinge control horns. Using the Expert Tip previously described, glue four hinges and a control horn into each of the ailerons, using a 3 x 458mm [1/8" x 18"] **wing leading edge tube** as a guide. The control horns should protrude from the bottom of the ailerons (red and white side), and the A1 Z-bend clevises should be on the inboard side of the horns. Remove the tube once the glue has set.

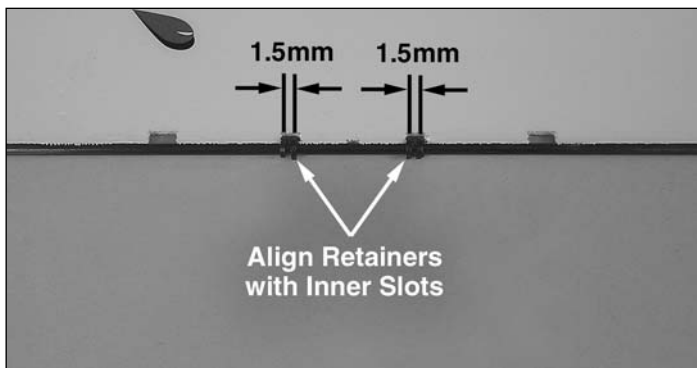
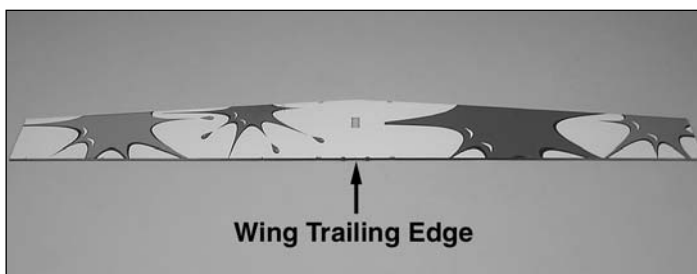

2. Slide four C3 hinge retainer rings onto the 3 x 914mm [1/8" x 36"] **wing trailing edge tube**. Position the rings so that they align with the inner slots in the TE of the foam wing. Secure the retainers with a drop of glue each on the outside of the gap. Glue the trailing edge tube to the TE of the wing.

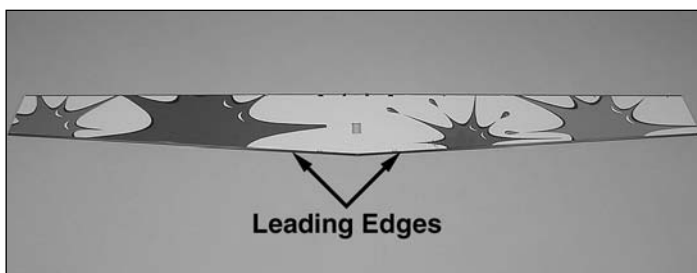

3. Glue the two 3 x 458mm [1/8" x 18"] **wing leading edge tubes** to the LE of the wing.

Final Airframe Assembly

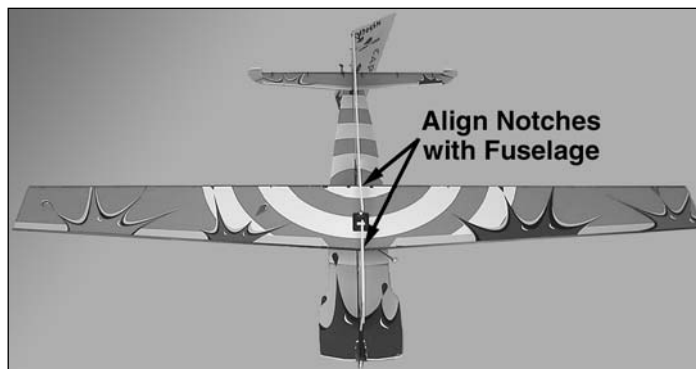

1. Glue the aileron servo into the F2 **wing servo mount**, and glue the servo mount into the precut opening in the wing. Slide the wing into the slot in the bottom of the vertical fuselage. Center the wing using the notches in the LE and TE as a guide. Once centered, glue the wing in place with a bead of glue on both sides of the joint.

2. Locate eight D2 **rod supports**. In the following steps note that four of the *supports* will be used for the main landing gear and four of the supports will be used for the wing struts at the trailing edge of the wing, but all of the supports are exactly the same.

IMPORTANT!!! Before gluing in any of the supports, be certain to read the steps all the way through so you will understand how the supports go in.

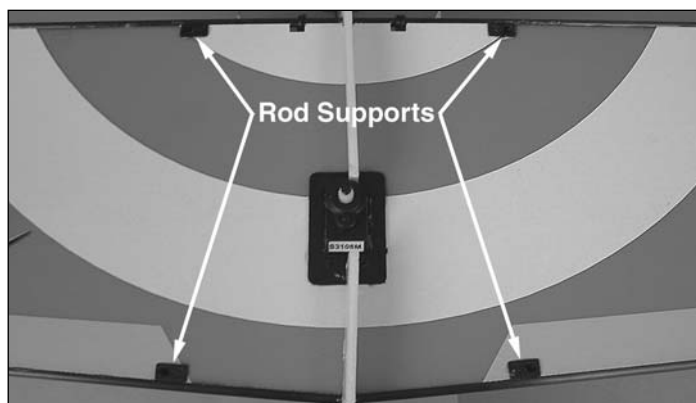
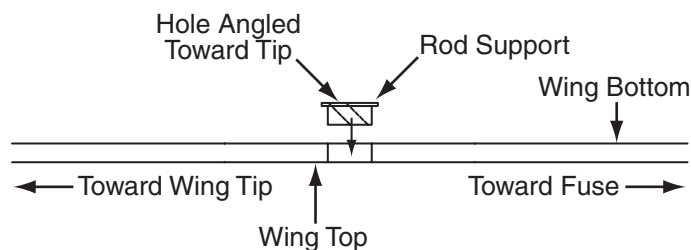

3. Installing them up through the bottom, glue four supports into the slots in both sides of the wing. Two of the supports are at the leading edge (for the landing gear) and two are at the trailing edge (for the wing struts). **IMPORTANT:** The holes in the supports must be angled **downward** and **outward** (matching the angle of the landing gear and the wing struts).



4. Installing them from the **left** side, glue two more supports into the slots in the fuselage. Note that these first two supports should be positioned **forward** in the slots, and that the holes in the supports should be angled downward and outward (again, to accommodate the angles of the landing gear and the struts).



5. Glue the remaining two supports into the right side of the fuselage. Be certain that the holes are angled correctly.

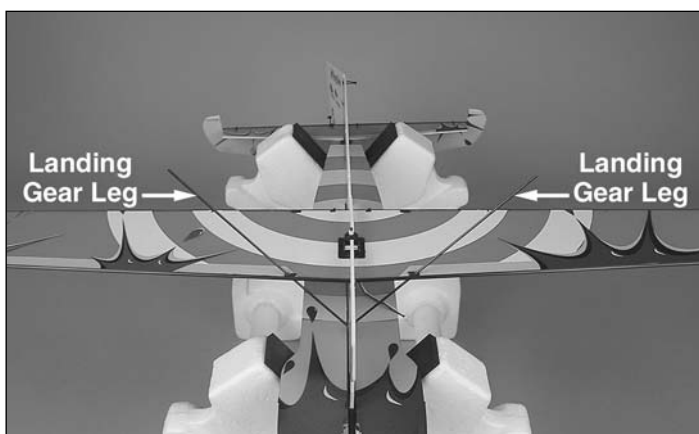

6. Slide the 2 x 190mm [5/64" x 7-1/2"] **landing gear legs** through the landing gear supports in the front of the wing and fuselage. Ensure that the wing is parallel with the stab and horizontal fuselage and perpendicular to the vertical fuselage. Once you are satisfied with alignment, secure the landing gear legs with a drop of glue on both sides of each joint.

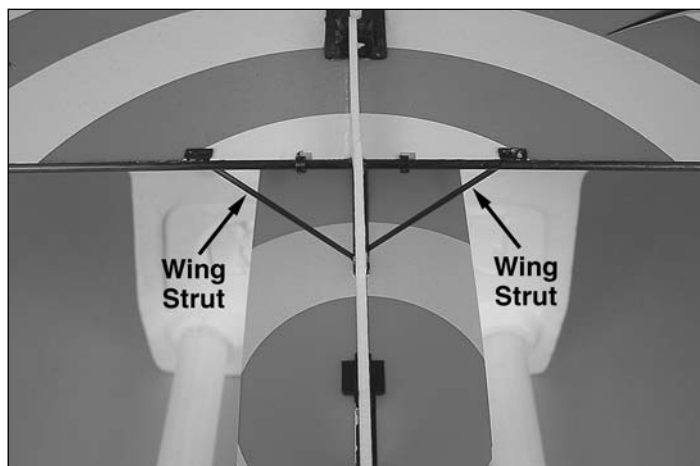

7. Slide the 2 x 71mm [5/64" x 2-3/4"] wing struts through both sets of supports on the back of the wing and fuselage. Make sure that the TE of the wing is aligned with the LE, and secure the struts with a drop of glue on both sides of each joint.

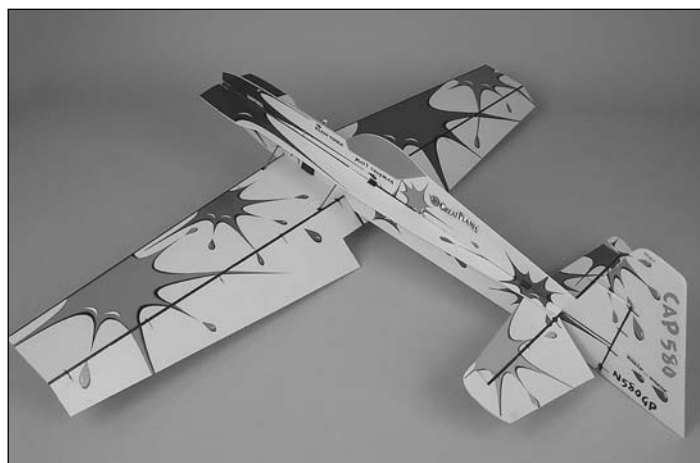

8. Snap the ailerons onto the wing trailing edge tube.

Finish the Landing Gear

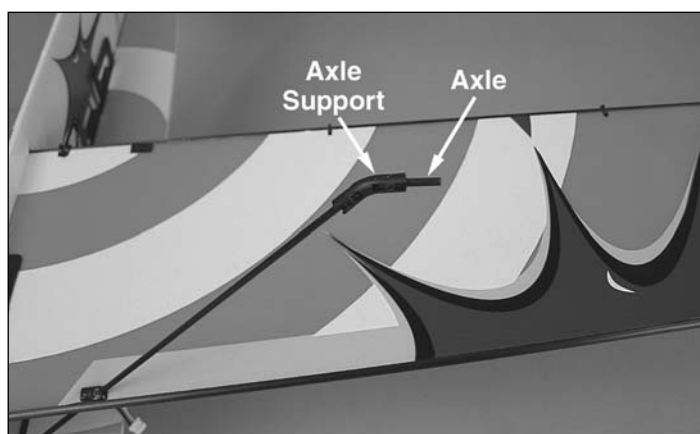

1. Install a 2 x 17mm [5/64" x 5/8"] **axle** and D1 **axle support** onto each landing gear leg. Position the axles so that they are perpendicular to the centerline. Secure the axles and supports with a drop of glue through the holes in both sides of the axle supports.

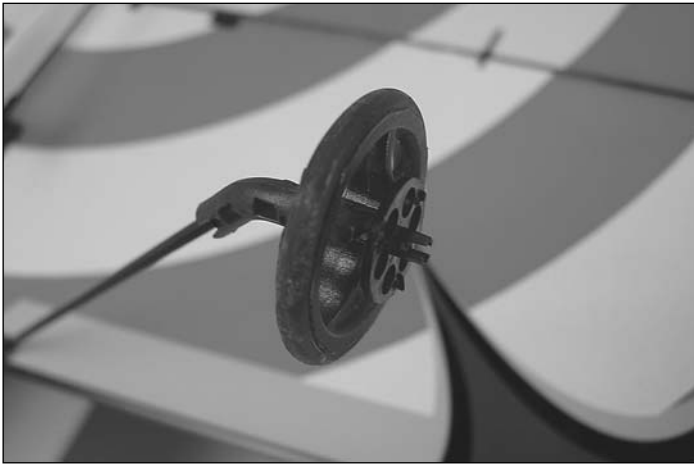

❑ 2. Slide the **wheels** onto the axles, and secure them with a D6 **wheel collar**. The flat side of the wheel collar should be toward the wheel. Secure the wheel collar with a drop of glue in the *teeth* opposite the wheels.



❑ 3. Make two wheel pants by gluing the **inner** and **outer wheel pant parts** together. Be sure to make a **right** and a **left**. Glue the inside of both wheel pants to the wheel collars.

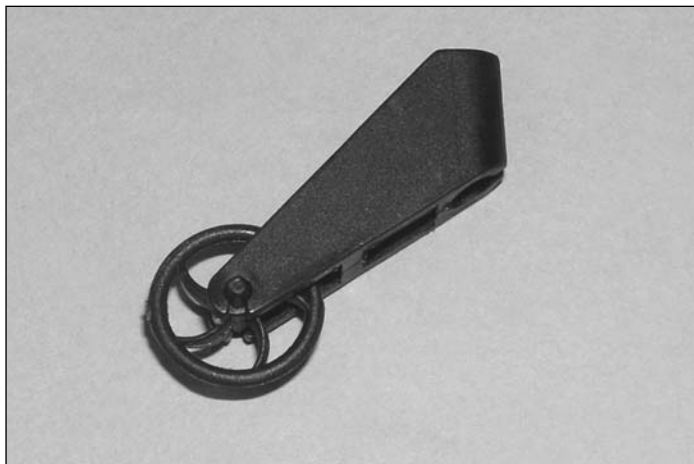

❑ 4. Snap the D5 **tailwheel** into the D4 **tailwheel bracket**.



❑ 5. Slide the tailwheel bracket over the rudder and rudder post. Glue the bracket to the rudder **only**. **Do not** glue the bracket to the rudder post.

Radio Setup

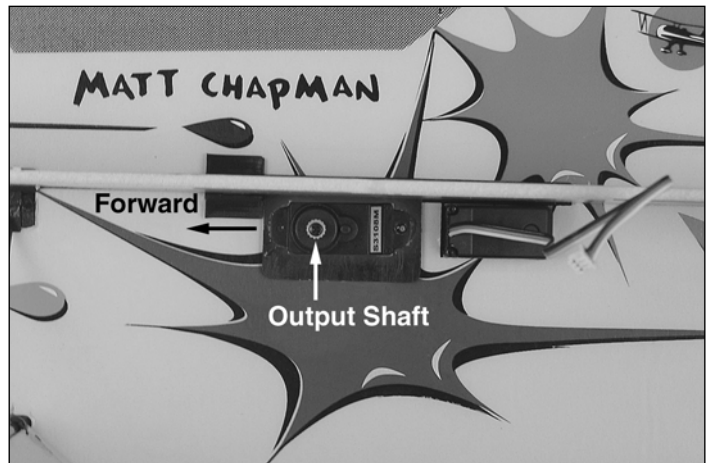

❑ 1. Glue the elevator servo into the **front** servo mount in the left side of the fuselage. The output shaft should be forward.

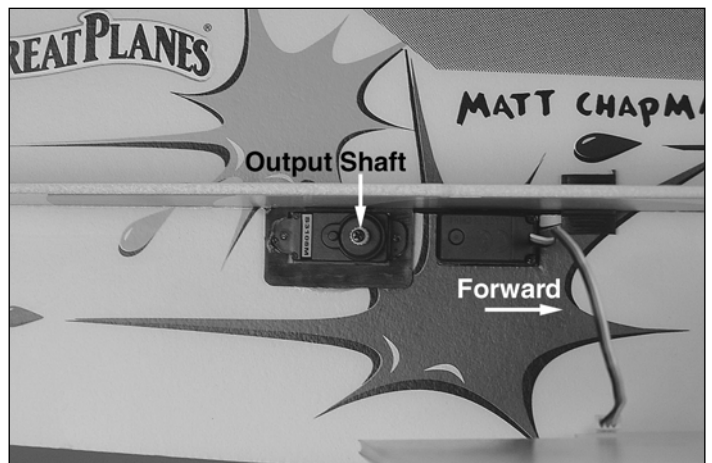

❑ 2. Glue the rudder servo into the **rear** servo mount in the right side of the fuselage. The output shaft should be forward.

❑ 3. Refer to the parts list in the front of the manual and select the correct **double-sided servo arm** for the aileron servo you will be using. There are three arms to choose from:

- Servo arm A Hitec HS-55, Hitec HS-50, Futaba 3108M
- Servo arm B Futaba S3103, Airtronics 94091
- Servo arm C JR 241



❑ 4. Connect two A1 Z-bend clevises to the outer holes of the servo arm you have selected.



❑ 5. Use your radio to center the aileron servo. Mount the double-sided servo arm to the aileron servo.



❑ 6. Select two single-sided servo arms to fit the elevator and rudder servos you are using. Insert an A1 Z-bend clevis into the outer hole of each arm. Use your radio to center the servos, and mount the servo arms so that they point straight down with the servos centered.

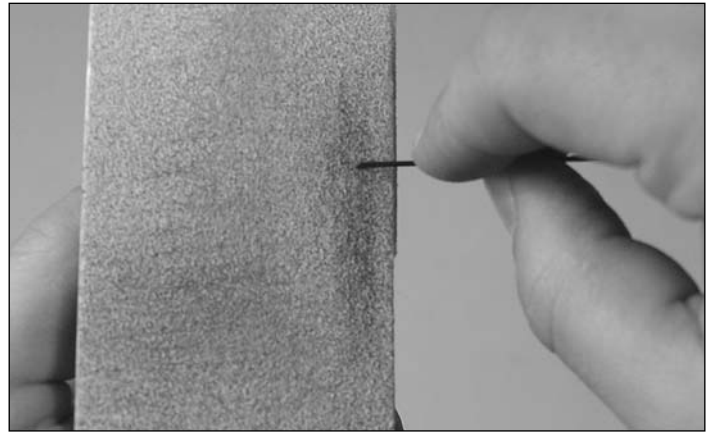

❑ 7. Using a 220-grit sanding block, sharpen the ends of all the 1mm carbon **pushrods**. This will make it much easier to install them through the Z-bend clevises.

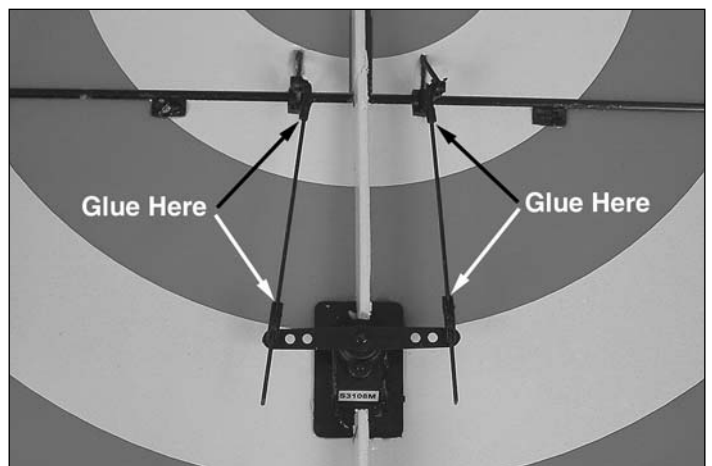

❑ 8. Slide a 1 x 80mm [.040" x 3-1/8"] **aileron pushrod** through the clevises in the aileron horns and servo arms. Adjust the clevises until the ailerons are centered with the servo centered. When you have the alignment correct, secure the pushrod with a drop of glue where the pushrod enters the clevis. Keep glue away from the end of the clevis where it pivots in the arm or horn.

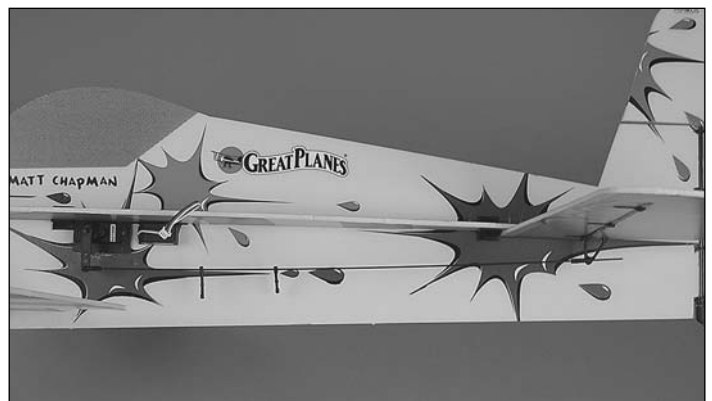

❑ 9. Slide two E3 **pushrod guides** onto the 1 x 290mm [.040" x 11-1/2"] **elevator pushrod** and slide the pushrod through the clevises on the elevator servo arm and control horn. Adjust the clevises until the elevator is centered with the servo centered. Secure the clevises with a drop of glue on each clevis where the pushrod enters it.

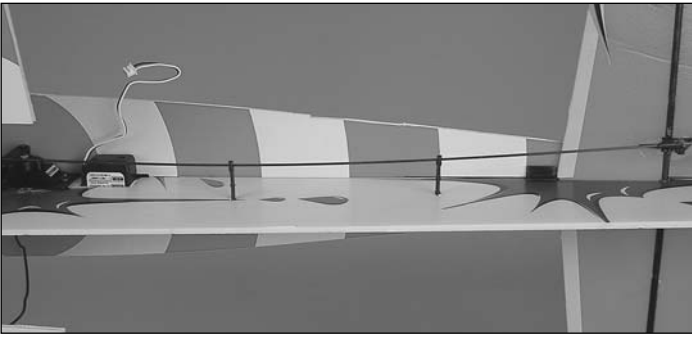

❑ 10. Using the pushrod as a guide, drill two evenly spaced, 2.5mm [3/32"] holes in the fuselage. Glue the bases of the pushrod guides into these holes.

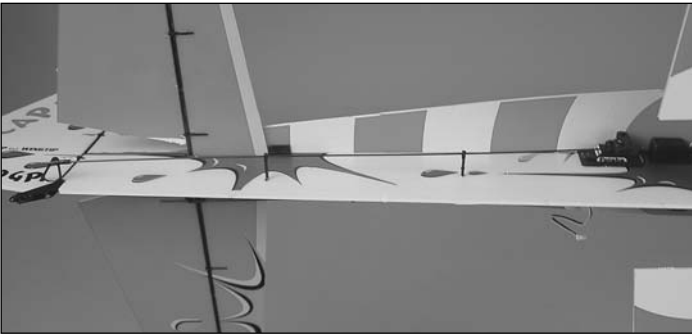

❑ 11. Install the 1 x 325mm [.040" x 12-3/4"] rudder pushrod the same way.

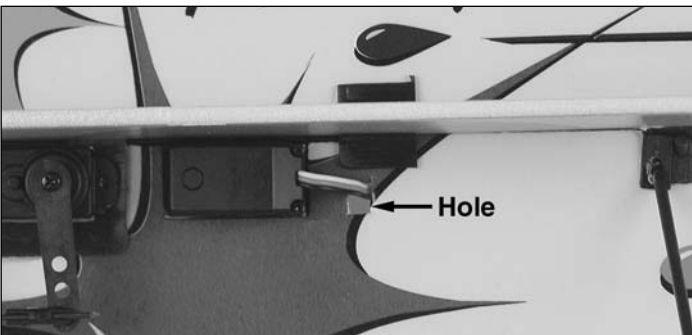

❑ 12. Cut a small hole to allow the elevator servo wire to pass through to the left side of the fuselage.



❑ 13. Connect all three servos to the receiver. Mount the receiver to the bottom of the left horizontal fuselage with double-sided foam tape. Make sure the receiver is far enough forward so that it does not interfere with aileron motion.

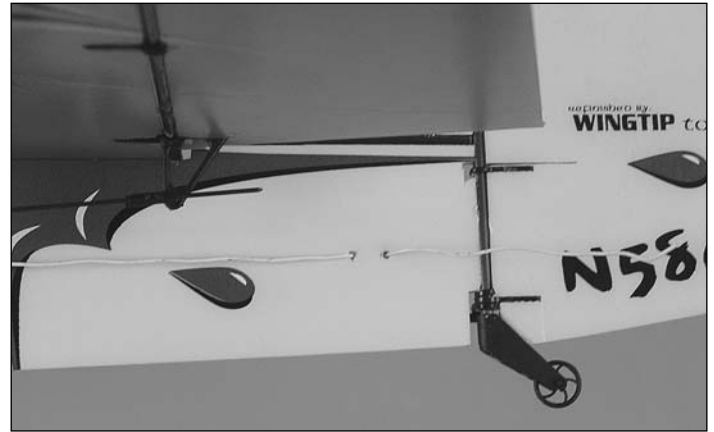

❑ 14. Drill two 1.5mm [1/16"] holes in the tail of the airplane. "Stitch" the receiver antenna through these holes.

Mount the Motor and Gearbox

If mounting the included stick-mounted propulsion system or an aftermarket geared brushless system, then follow the instructions in this section. If you are installing a firewall-mounted system, proceed to "**Firewall-Mounted Systems**" on page 17.

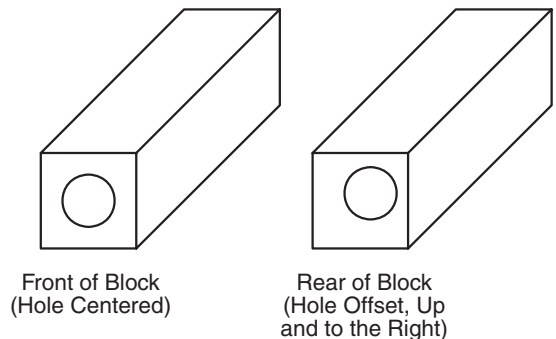

❑ 1. The 10 x 10 x 22mm hardwood **motor mount block** must be mounted in the correct orientation to insure the proper right thrust. Identify the top, aft end of the block as shown in the sketch so you will know how it is to be installed.

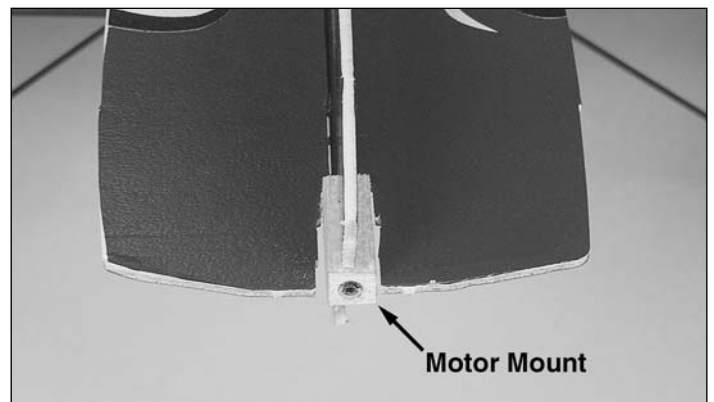

❑ 2. **Without using any glue**, slide the motor mount block over the fuselage tube. Be certain the block is in the correct position so there will be up and right thrust. **Do not** glue the motor mount block onto the fuselage tube.

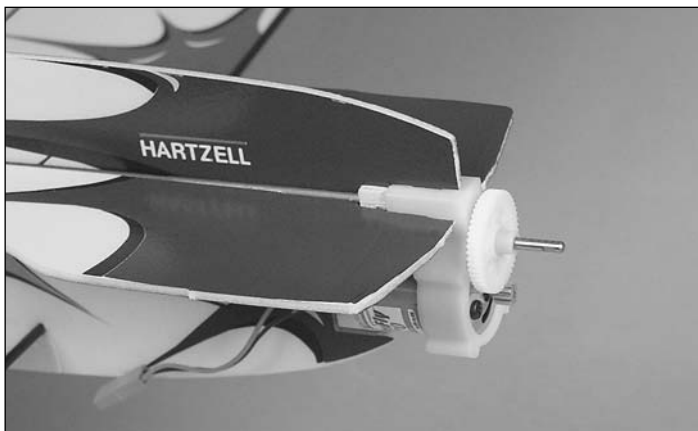

❑ 3. Slide the **motor/gearbox assembly** over the motor mount block.

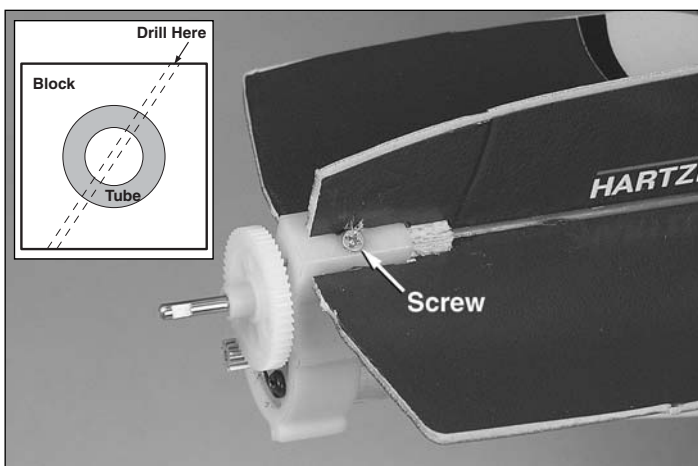

❑ 4. Drill a 1.5mm [1/16"] pilot hole at an angle from the top of the gearbox through the balsa block and carbon tubes. Make sure the motor mount block does not rotate while drilling. Secure the gearbox and block with a 2mm wood screw.

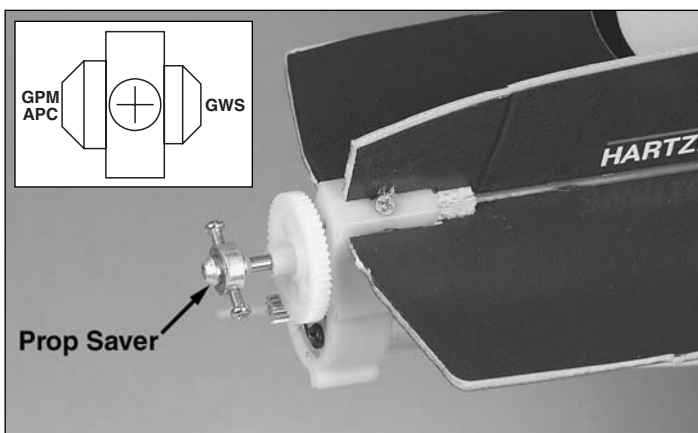

❑ 5. If using the included propeller, install the **prop saver** onto the gearbox shaft with the large-diameter cone forward. If using a GWS prop, install the prop saver with the small-diameter cone forward. Tighten the screws, making sure they engage the flat spots on the shaft.

❑ 6. If using an APC prop, insert the larger of the two **adapter rings** (included in the propeller packaging) into the rear of the propeller hub.

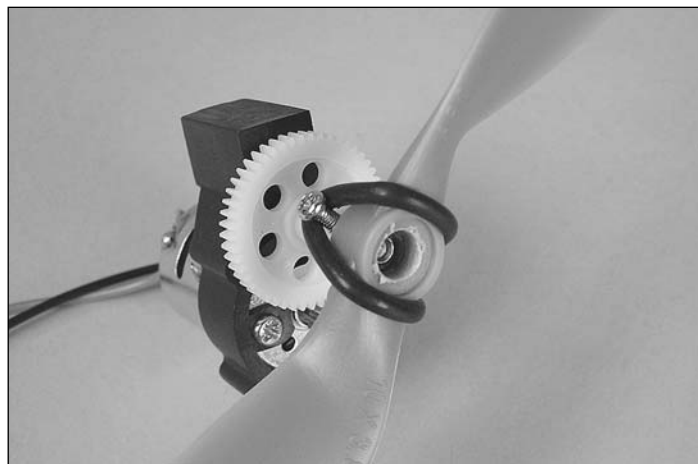

❑ 7. Secure the prop to the prop saver with one of the included O-rings.

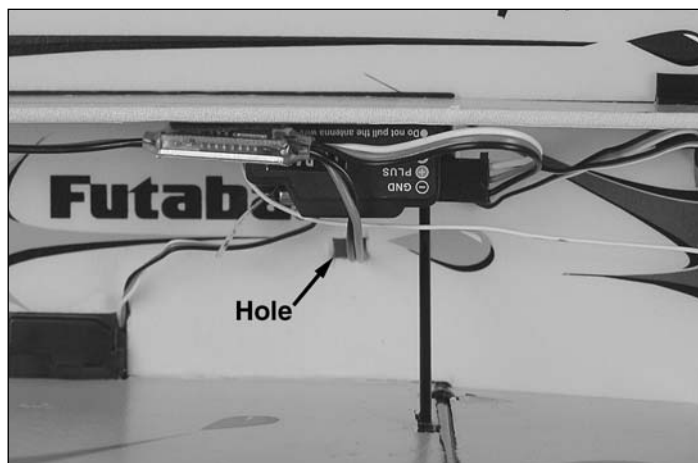

❑ 8. Connect your speed control to the motor and receiver. Mount the speed control to the bottom of the left horizontal fuselage with double-sided foam tape. Cut a small hole for the ESC's battery wire to cross to the right side of the fuselage.



❑ 9. Install the "hook" side of the included hook-and-loop material to the right side of the fuselage where shown. This is where you will mount your battery.

Firewall Mounted System

Use the following instructions if you are installing a firewall-mounted motor system (usually brushless motors).

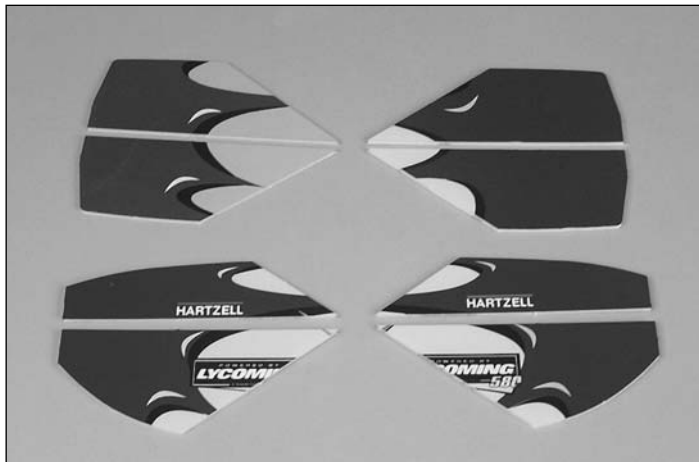

- ❑ 1. Cut the **nose doublers** free from their foam sheets

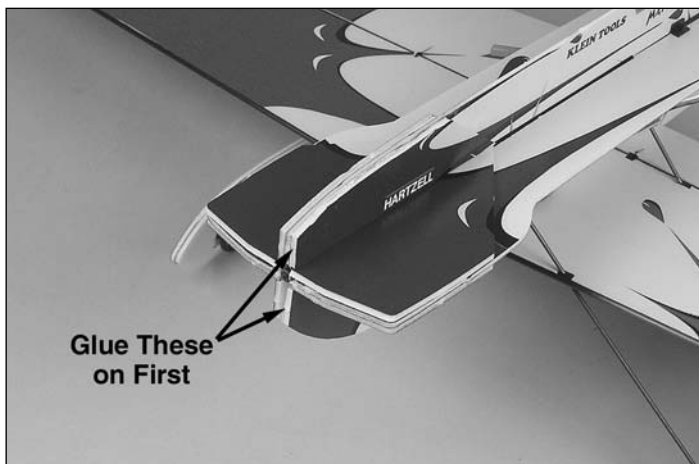

- ❑ 2. Glue the doublers for the vertical fuselage into position first, then glue the doublers for the horizontal fuselage into position.

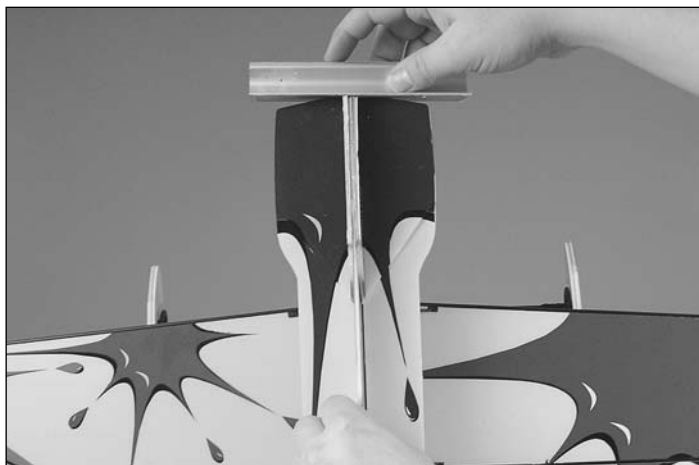

- ❑ 3. Use a 220-grit sanding block to sand the front of the fuselage smooth. Be careful not to change the built-in thrust angles.



- ❑ 4. If installing an Electrify RimFire motor, glue the included 3mm plywood firewall to the nose so that the two pilot holes on the sides of the firewall are centered on the horizontal fuselage, and the top hole is centered on the fuselage tube.

NOTE: If installing another brand of outrunner motor, you may need to cut your own firewall to match its mount pattern. The motor and firewall should be mounted so that the thrustline is offset 9mm below the center of the fuselage tube.



- ❑ 5. Mount the motor to the firewall using the hardware supplied with your motor.



- ❑ 6. Mount a propeller to the motor according to the instructions that came with your motor.

- ❑ 7. Install your ESC in the same manner as outlined in steps 7-8 of the stick-mount installation section above.

GET THE MODEL READY TO FLY

Check the Control Directions



- ❑ 1. Attach the “loop” side of the hook-and-loop material to the battery. Mount the battery to the fuselage.
- ❑ 2. Remove the propeller for safety while performing bench setup. Once you have finished setting up your airplane, you can reinstall it.
- ❑ 3. Set the throttle stick at its minimum position and turn on the transmitter. Connect your battery to the ESC. If the ESC has a BEC switch, turn it on.
- ❑ 4. Check all the control surfaces to see if they are centered. Since you set the center points as you set up the linkages, they should already be very close. Use your radio's trims on the transmitter to center the controls.

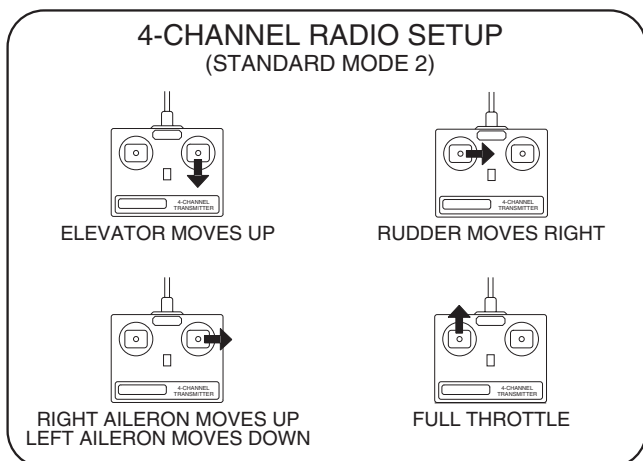

- ❑ 5. Make certain that the control surfaces and the motor respond in the correct direction as shown in the diagram. To operate the motor, you may have to “arm” your ESC. Follow the instructions that came with your ESC to do this. If any of the controls respond in the wrong direction, use the servo reversing in the transmitter to reverse the servos connected to those controls. Be certain the control surfaces have remained centered. Adjust if necessary.

Set the Control Throws

To simplify setup, the high-rate (3-D) control throws for this model are automatically set by the geometry of the included hardware. We do recommend, however, that you perform a quick check as described below to make sure the throws are set up correctly.

Note: If your radio has the capability, low rates will make it easier to perform precision aerobatics. We recommend 40% endpoints for all low rate throws. If your radio does not have low rates, set up the plane using only the high-rate throws.

Additionally, you may want to use the exponential function to soften the control response around center. This is largely a matter of personal taste, but helps many pilots balance the extreme throws needed for 3-D flying with the need to make small corrections when in normal flight.

We recommend setting up your airplane according to the following table *as a starting point*. However, setting up models of this type is largely a matter of personal taste. We encourage you to tune the throws to your taste as you get more familiar with the aircraft. Many expert 3-D fliers choose to increase their high rate travel by using higher endpoints.

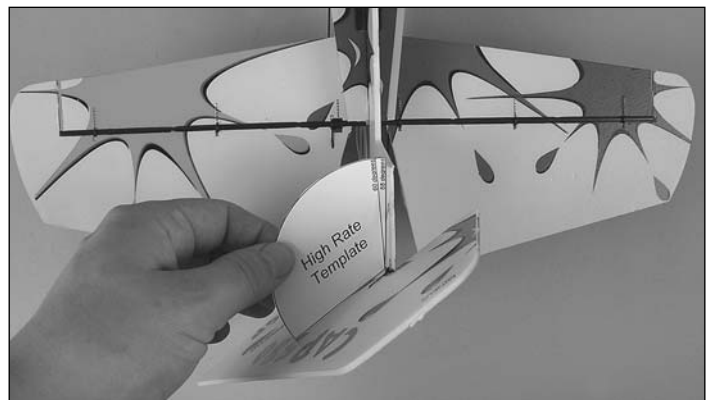

To set the throws, use the angle templates on the back cover of this manual to verify that you are in the ballpark.

Function	High Rate Endpoints	High Rate Travel	High Rate Exponential
Aileron	+/- 100%	+/- 55-60°	40%
Elevator	+/- 100%	+/- 55-60°	40%
Rudder	+/- 100%	+/- 55-60°	40%
Function	Low Rate Endpoints	Low Rate Travel	Low Rate Exponential
Aileron	+/- 40%	+/- 15-25°	0%
Elevator	+/- 40%	+/- 15-25°	0%
Rudder	+/- 40%	+/- 15-25°	0%

If you are not able to achieve these control throws, double-check your pushrod hookup and make sure any control surfaces in question are operating smoothly. If you have a computer radio also make sure your endpoint adjustments are properly set.

Balance the Model (C.G.)

More than any other factor, the **C.G.** (balance point) can have the **greatest** effect on how a model flies, and may determine whether or not your first flight will be successful. If you value this model and wish to enjoy it for many flights, **DO NOT OVERLOOK THIS IMPORTANT PROCEDURE.** A model that is not properly balanced will be unstable and possibly unflyable.

At this stage the model should be in ready-to-fly condition with all of the systems in place including the motor, the propeller, the battery, and the radio system.

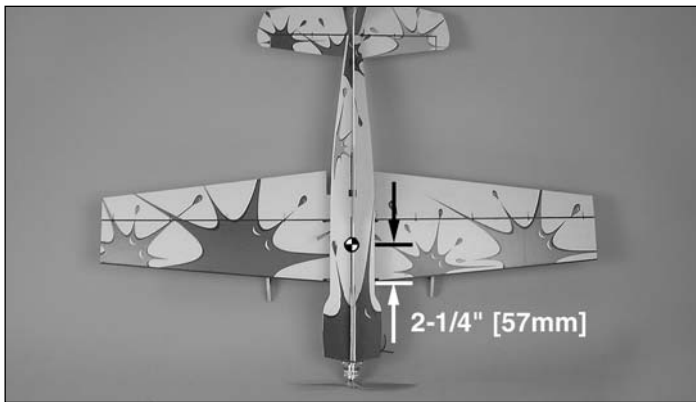

1. Use a felt-tip pen or 1/8" [3mm]-wide tape to accurately mark the C.G. on the top of the wing on both sides of the fuselage. **The C.G. is located 2-1/4" [57mm] back from the leading edge of the wing at the fuselage.**

This is where your model should balance for the first flights. Later, you may wish to experiment by shifting the C.G. up to 1/2" [13mm] forward or 1/2" [13mm] back to change the flying characteristics. Moving the C.G. forward may improve the smoothness and stability, but the model may then require more speed for takeoff and make it more difficult to slow for landing or 3-D aerobatics. Moving the C.G. aft makes the model more maneuverable, but could also cause it to become too difficult to control. In any case, **start at the recommended balance point.** As with the throws, though, we encourage you to experiment with the CG until the model flies to your taste.

2. With all parts of the model installed, including the battery (ready to fly), lift it upside-down on your fingertips at the balance point you marked.

3. If the tail drops, the model is "tail heavy" and the battery pack and/or receiver must be shifted forward. If the nose drops, the model is "nose heavy" and the battery pack and/or receiver must be shifted aft. Relocate the battery pack on the hook-and-loop strip to minimize or eliminate any additional ballast required.

4. **IMPORTANT:** If you moved any components, recheck the C.G.

Balance the Model Laterally

1. With the wing level, lift the model by the engine propeller shaft and the bottom of the fuse under the TE of the fin. Do this several times.

2. If one wing always drops when you lift the model, it means that side is heavy. Balance the airplane by adding weight to the other wing tip. **An airplane that has been laterally balanced will track better in loops and other maneuvers.**

PREFLIGHT

Identify Your Model

No matter if you fly at an AMA sanctioned R/C club site or if you fly somewhere on your own, you should always have your name, address, telephone number and AMA number on your model. It is **required** at all AMA R/C club flying sites and AMA sanctioned flying events. Write this information on the bottom of the wing with a fine felt-tip pen.

Charge the Batteries

Follow the battery charging instructions that came with your radio control system to charge the batteries. You should always charge your transmitter batteries the night before you go flying, and at other times as recommended by the radio manufacturer.

Charge the flight battery using a charger designed for Lithium Polymer batteries. Charging with any other type of charger is very dangerous, and may cause the batteries to combust violently.

CAUTION: Unless the instructions that came with your radio system state differently, the **initial** charge on **new** transmitter batteries should be done for 15 hours **using the slow-charger that came with the radio system.** This will "condition" the batteries so that the next charge may be done using the fast-charger of your choice. If the initial charge is done with a fast-charger the batteries may not reach their full capacity and you may be flying with batteries that are only partially charged.

Range Check

Ground check the operational range of your radio before the first flight of the day. With the transmitter antenna collapsed and the receiver and transmitter on, you should be able to walk at least 50 feet away from the model and still have control. Have an assistant stand by your model and, while you work the controls, tell you what the control surfaces are doing. Repeat this test **with the motor running** at various speeds with an assistant holding the model, using hand signals to show you what is happening. If the control surfaces do not respond correctly, **do not fly!** Find and correct the problem first. Look for loose servo connections or broken wires, corroded wires on old servo connectors, poor solder joints in your battery pack or a defective cell, or a damaged receiver crystal from a previous crash.

MOTOR SAFETY PRECAUTIONS

Failure to follow these safety precautions may result in severe injury to yourself and others.

Keep your face and body as well as all spectators away from the plane of rotation of the propeller whenever the battery is connected.

Keep these items away from the prop: loose clothing, shirt sleeves, ties, scarfs, long hair or loose objects such as pencils or screwdrivers that may fall out of shirt or jacket pockets into the prop.

AMA SAFETY CODE (EXCERPTS)

Read and abide by the following excerpts from the Academy of Model Aeronautics Safety Code. For the complete Safety Code refer to *Model Aviation* magazine, the AMA web site or the Code that came with your AMA license.

General

1. I will not fly my model aircraft in sanctioned events, air shows, or model flying demonstrations until it has been proven to be airworthy by having been previously, successfully flight tested.

2. I will not fly my model aircraft higher than approximately 400 feet within 3 miles of an airport without notifying the airport operator. I will give right-of-way and avoid flying in the proximity of full-scale aircraft. Where necessary, an observer shall be utilized to supervise flying to avoid having models fly in the proximity of full-scale aircraft.

3. Where established, I will abide by the safety rules for the flying site I use, and I will not willfully and deliberately fly my models in a careless, reckless and/or dangerous manner.

5. I will not fly my model unless it is identified with my name and address or AMA number, on or in the model. Note: This does not apply to models while being flown indoors.

7) I will not operate models with pyrotechnics (any device that explodes, burns, or propels a projectile of any kind).

Radio Control

1) I will have completed a successful radio equipment ground check before the first flight of a new or repaired model.

2) I will not fly my model aircraft in the presence of spectators until I become a qualified flier, unless assisted by an experienced helper.

3) At all flying sites a straight or curved line(s) must be established in front of which all flying takes place with the other side for spectators. Only personnel involved with flying the aircraft are allowed at or in the front of the flight line. Intentional flying behind the flight line is prohibited.

4) I will operate my model using only radio control frequencies currently allowed by the Federal Communications Commission.

5) **I will not knowingly operate my model within three miles of any pre-existing flying site except in accordance with the frequency sharing agreement listed** [in the complete AMA Safety Code].

9) Under no circumstances may a pilot or other person touch a powered model in flight; **nor should any part of the model, other than the landing gear, intentionally touch the ground except while landing.**

CHECK LIST

During the last few moments of preparation your mind may be elsewhere anticipating the excitement of the first flight. Because of this, you may be more likely to overlook certain checks and procedures that should be performed before the model is flown. To help avoid this, a check list is provided to make sure these important areas are not overlooked. Many are covered in the instruction manual, so where appropriate, refer to the manual for complete instructions. Be sure to check the items off as they are completed.

- 1. Check the C.G. according to the measurements provided in the manual.
- 2. Be certain the battery and receiver are securely mounted on the fuse.
- 3. Extend your receiver antenna and make sure it cannot get tangled in the prop.
- 4. Balance your model *laterally* as previously explained in the instructions.
- 5. Make sure all hinges are **securely** glued in place.
- 6. Confirm that all controls operate in the correct direction and the throws are set up according to the manual.
- 7. Make sure any servo wiring does not interfere with other systems (servo arms, pushrods, etc.).
- 8. Place your name, address, AMA number and telephone number on your model.
- 9. If you wish to photograph your model, do so before your first flight.
- 10. Range check your radio when you get to the flying site.

FLYING

The FlatOut CAP 580 is a great-flying model that flies smoothly and predictably. The FlatOut CAP 580 does not, however, possess the self-recovery characteristics of a primary R/C trainer and should be flown only by experienced R/C pilots.

Hand Launch

For the first flight, it is a good idea to have an assistant launch the airplane for you. This allows you to keep your hands on the controls and correct any trim problems that are present.

Have your friend hold the FlatOut CAP 580 by the canopy. Throttle up to full power, and have your friend give the plane a gentle underhanded toss at about a 30-degree angle upward. Since the CAP 580 has a very high thrust-to-weight ratio, the plane will accelerate to flying speed almost instantly. Climb to a comfortable height and throttle back to a lower power setting. This plane flies great at about half-throttle when in standard forward flight.

Rise-Off-Ground (ROG) Takeoffs

Once you have the model trimmed out, the FlatOut CAP 580 is very capable of ROG (rise-off-ground) takeoffs from a smooth surface (parking lot, runway, gym floor, etc.). To take off, start by advancing the throttle to about two-thirds, making sure to correct any torque reactions with rudder. The plane will build flying speed almost instantly due to its high thrust-to-weight ratio. Once the tail comes up, gently apply up elevator to break ground and climb out. Full throttle takeoffs are necessary only for extremely short runways.

Flight

When flying a 3-D aerobat like the CAP 580, there are several things you should always keep in mind. First is throttle management—this airplane has enough power to climb straight up at full throttle, so level flight is more comfortably achieved at about half-throttle. Avoid extremely high-speed flight with the FlatOut CAP 580 – it is designed for slow 3-D aerobatics, and extended full-throttle dives can result in wing flutter. While flutter won't destroy the airplane, it's best to avoid it. Second, take it easy on the control sticks—with 3-D throws, even a small stick deflection can result in a big response, so be gentle (unless of course you're performing an aggressive maneuver).

Landing

Because this model is extremely lightweight, it does not retain energy well, and performing classic gliding landings can be difficult. Instead, land the model under power, with a rolling 3-point landing as the goal. To achieve this, perform your landing approach with the model in the 3-point attitude (nose up at such an angle that all three wheels are level). Modulate your descent with the throttle, and use a quick "blip" of power just before touchdown to slow the descent for a gentle landing.

Have a ball!

But always stay in control and fly in a safe manner.

GOOD LUCK AND GREAT FLYING!

ElectriFly™ by Great Planes® Triton Peak Charger (GPMM3150)

Computer-controlled for the ultimate in charging versatility and precision.

Imagine a charger so versatile it can be used with lithium-ion and lead-acid batteries as effectively as NiCd and NiMH cells. A unit that can peak charge tiny park flyer packs and 24V car batteries alike. A charger that can discharge as well as charge, cycle packs from 1 to 10 times automatically, memorize peak and average battery voltages for each cycle - and constantly display battery capacity, voltage, current and time as each cycle progresses. Then, imagine that the charger, which can do all this, is about the size of a thick paperback book, and weighs just over a pound. The advanced computer technology in the Triton Peak Charger makes it possible to accomplish all this and more, through controls and menus so simple that programming is a breeze. For more information, log on at www.electrifly.com - and be amazed. 1-year warranty.



Hobbico® 12V Power Supply (HCAP0250)

The 12V Power Supply transforms 110V AC current into constant 13.8V, 11.5A DC power for peak chargers, motor break-in and more. It includes fuse protection, 5V tap, a lighted on/off switch and one-year warranty protection.

Other Items Available from Great Planes

ElectriFly™ BL-8 Brushless Electronic Speed Control (GPMM2070)

ElectriFly's BL-8 is a fully proportional forward/reverse ESC with brake. Compatible with NiCd, NiMH, and Li-Po batteries, it has custom BEC that handles up to 1.5A—perfect for models that use up to three high-powered servos. Programmable features include brake control, safe start, and switching frequency.



ElectriFly™ RimFire™ 22M-1000 Brushless Motor (GPMG4500)

Perfect for small, high performance planes such as FlatOuts and smaller 3D aerobats, the RimFire has an exceptionally high power-to-weight ratio and an efficiency rating of 77%! Its "outrunner" design eliminates the need for an external gear drive, for easier installation and less weight. Simply attach the prop to the motor with a rubber band (no prop adapter required)...the prop will simply "pop" off in a crash.

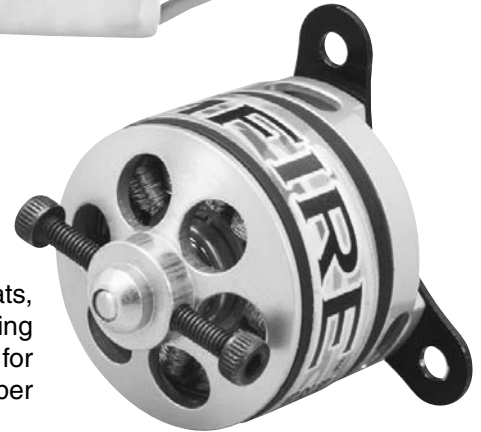

Hobbico® Pro Series™ Quick Field Charger MkII (HCAP0290)

The MkII is two completely independent chargers in a single case! Current on both sides adjusts from 0.2-2A, to fast charge 1-3 cell Li-Ion or Li-Po park flyer batteries or peak charge 1-8 cell NiCd or NiMH radio packs. Auto-trickle for NiCds and NiMH packs is automatically set, based on the fast-charge rate. Hook up the pack, press the start button - and twin LEDs signal the cell type and charge method to be used by color: red for NiCd, yellow for NiMH and green for Li-Ion or Li-Po cells. Jacks make it easy to hook up your pack - and a voltmeter - to either side.

Control Throw Templates

