



## *Assembly manual for the Easy Sport 40 and 60*

### WARRANTY

Great Planes Model Manufacturing Co guarantees this kit to be free from defects in both material and workmanship at the date of purchase. This warranty does not cover any component parts damaged by use or modification. **In no case shall Great Planes' liability exceed the original cost of the purchased kit.** Further, Great Planes reserves the right to change or modify this warranty without notice.

In that Great Planes has no control over the final assembly or material used for final assembly, no liability shall be assumed nor accepted for any damage resulting from the use by the user of the final user-assembled product. By the act of using the user-assembled product, the user accepts all resulting liability.

**If the buyers are not prepared to accept the liability associated with the use of this product, they are advised to return this kit immediately in new and unused condition to the place of purchase.**

**READ THROUGH THIS INSTRUCTION BOOK FIRST. IT CONTAINS IMPORTANT INSTRUCTIONS AND WARNINGS CONCERNING THE ASSEMBLY AND USE OF THIS MODEL.**



PO Box 788

Urbana Illinois 61801

(217)3988970

# Table of Contents

Introduction .....	3	Finish the fuselage.....	33
Precautions.....	3	Final assembly.....	35
Abbreviations .....	4	Cut center fairing from fuselage.....	35
Types of wood.....	4	Mount wing to fuselage.....	36
Metric conversion chart.....	4	Engine installation.....	40
<b>Decisions you must make.....</b>	<b>4</b>	Fuelproof the fuselage.....	40
Engine selection .....	4	Install horizontal <b>stab</b> .....	<b>41</b>
Landing gear configuration .....	4	Install vertical fin .....	41
Die-cut patterns.....	5, 6	Mount landing gear.....	42
Required items.....	7	Final fit of the engine .....	44
Tools and supplies .....	7	Install radio and pushrods.....	44
Preparing the work surface.....	7	<b>Finishing.....</b>	<b>46</b>
Get ready to build.....	8	Additional fuelproofing .....	46
<b>Tail feathers.....</b>	<b>8</b>	Balance the airplane laterally.....	46
Build the rudder .....	8	Remove the engine and radio.....	47
Build the fin.....	9	Final sanding .....	47
Build the <b>stabilizer</b> .....	<b>9</b>	Covering .....	47
Build the elevators .....	10	Recommended covering sequence.....	47
Join the elevators.....	10	Applying trim and decals.....	47
Install the hinges.....	10	Glue the hinges.....	48
<b>Wing assembly.....</b>	<b>12</b>	Install the pilot.....	48
Prepare wing parts.....	12	Install canopy.....	49
Spars.....	12	Wing seating.....	49
Ribs.....	12	Reinstall engine & <b>radio</b> .....	<b>50</b>
Leading and trailing edges.....	13	Install wheels.....	50
Leading edge joiner .....	13	Balance your model .....	50
Build the wing panels.....	13	Final hookups and checks .....	51
Join the wing panels .....	15	Preflight.....	51
Install the center ribs and sheeting.....	17	Balance the propeller.....	51
Install the wing tips .....	21	Find a safe place to fly.....	51
Install the ailerons.....	21	Ground check the model.....	52
Install the wing bolt plate .....	22	Range check the radio.....	52
<b>Fuselage assembly.....</b>	<b>23</b>	Engine safety precautions .....	52
Fuselage sides.....	23	<b>AMA safety code .....</b>	<b>53</b>
Firewall assembly .....	24	General.....	53
Former preparation.....	26	Radio control.....	53
Assemble the fuselage .....	26	<b>Flying .....</b>	<b>53</b>
Install landing gear mounts.....	28	Takeoff.....	53
Install the firewall .....	29	Flying.....	53
Install the landing gear blocks .....	30	Landing.....	54
Install the pushrod guide tubes.....	32	<b>Two-view drawing.....</b>	<b>Back Cover</b>

**Protect your model, yourself & others...  
follow this important safety precaution**

Your Easy Sport is not a toy, but rather a sophisticated, working model that functions very much like an actual airplane.

Because of its realistic performance, the Easy Sport, if not assembled and operated correctly, could possibly cause injury to yourself or spectators and damage property

**To make your R/C modeling experience totally enjoyable, we recommend that you get experienced, knowledgeable help with assembly and during your first flights.** You'll learn faster and avoid risking your model before you're truly ready to solo. Your local hobby shop has information about flying clubs in your area whose membership includes qualified instructors

You can also contact the national Academy of Model Aeronautics (AMA), which has more than 2,300 chartered clubs across the country. Through any one of them, instructor training programs and insured newcomer training are available

Contact the AMA at the address or toll-free phone number below.

**Academy of Model Aeronautics  
5151 East Memorial Drive  
Muncie, IN 47302-9252  
Tel: (800) 435-9262  
Fax:(317)741-0057**

## **Introduction**

Thank you for choosing the Great Planes Easy Sport as your new project. Now that you have mastered the basics of flight with your primary trainer, you are now ready to advance to the next higher level - a level that will open the doors to aerobatics. With the experience you've acquired with your trainer along with the Great Planes Easy Sport, you will be able to experiment with, and master, the maneuvers that your club pros perform.

The Easy Sport, with its shoulder mounted wing, rugged construction and heavy-duty landing gear, will allow you to practice and perfect any maneuver you desire. But don't let its aerobatic qualities put you off. The Easy Sport is also an extremely docile flier. Thanks to its thick semi-symmetrical airfoil, generous moments and light wing loading, you'll be able to "grease her in" every time.

If you've mastered your trainer and are ready to progress to advanced flight maneuvers, the Great Planes Easy Sport is just the ticket for easy-flying, smooth aerobatics. Welcome to the world of sport flying.

The Easy Sport is not a beginner's airplane! It is relatively fast, highly maneuverable, and lacks the self-recovery characteristics of a good basic trainer such as the Great Planes PT-40 MkII. If you have already learned the basics of R/C flying and can safely handle a basic trainer, the Easy Sport is an excellent choice to sharpen your skills and learn more advanced maneuvers.

We think you will agree that the Great Planes Easy Sport is the highest quality, best flying model of its type on the market today!

**Please inspect all parts carefully before starting to build! If any parts are missing, broken or defective, or if you have any questions about building or flying this model, please call us at (217) 398-8970 and we'll be glad to help. If you are calling for replacement parts, please look up the part numbers and the kit identification number (stamped on the end of the carton) and have them ready when calling.**

**NOTE: We, as the kit manufacturer, can provide you with a top quality kit and great instructions, but ultimately the quality and flyability of your finished model depends on how you build it; therefore, we cannot in any way guarantee the performance of your completed model, and no representations are expressed or implied as to the performance or safety of your completed model.**

**Remember: Take your time and follow directions to end up with a well-built model that is straight and true.**

## **Precautions**

1. You must assemble the plane according to the instructions. Do not alter or modify the model, as doing so may result in an unsafe or unflyable model. In a few cases the instructions may differ slightly from the photos. In those instances you should assume the written instructions are correct.

2. You must take time to build straight, true and strong.

3. You must properly install all R/C components and other items so that the model operates properly on the ground and in the air.

4. You must test the operation of the model before the first and each successive flight to insure that all equipment is operating, and you must make certain that the model has remained structurally sound.

## Important note about this manual

Both the Easy Sport 40 and 60 are built from this manual. Nearly all the parts in the Easy Sport series are identical, so most of the differences are only in the size and thicknesses of the pieces - you can't even tell from most of the photos. When important differences do arise between the 40 and 60, they are clearly indicated so you'll have all the information you need to build your model.

## Commonly used abbreviations

deg = Degrees	Ply = Plywood
Elev = Elevator	Rt = Right
Fuse = Fuselage	Stab = Stabilizer
LE = Leading Edge (front)	TE = Trailing Edge (rear)
LG = Landing Gear	" = Inches
Lt = Left	

## Types of wood

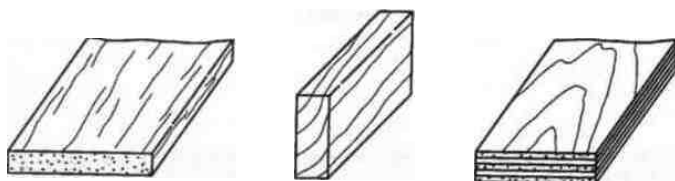

Balsa

Basswood

Plywood

## Metric Conversion Chart

Inches x 25.4		mm (conversion factor)					
1/64"	.4mm	3/16" =	4.8 mm	1"	25.4 mm	21"	533.4 mm
1/32"	.8 mm	1/4" =	6.4 mm	2"	50.8 mm	24"	609.6 mm
1/16"	1.6 mm	3/8" =	9.5 mm	3"	76.2 mm	30"	762.0 mm
3/32"	2.4 mm	1/2" =	12.7mm	6"	152.4 mm	36"	914.4 mm
1/8"	3.2mm	5/8" =	15.9mm	12"	304.8 mm		
5/32"	4.0mm	3/4" =	19.0mm	18"	457.2 mm		

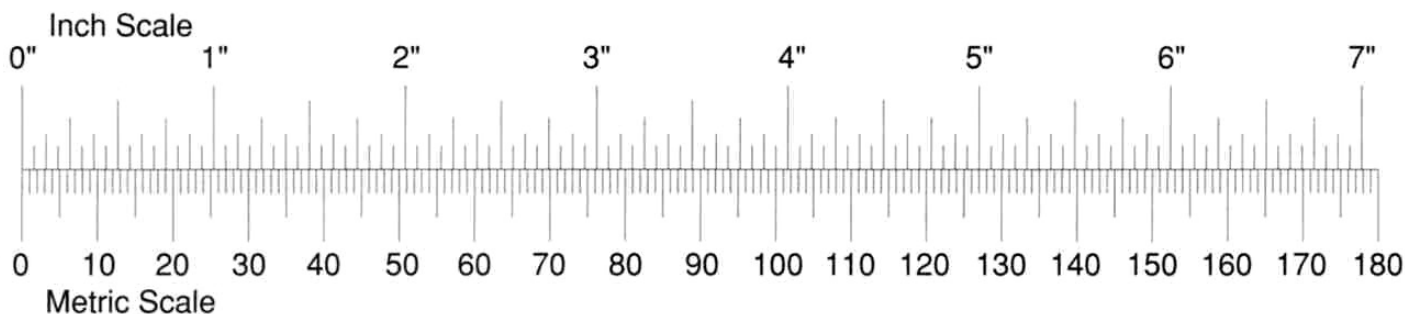

## Decisions You Must Make

### Engine selection

The recommended engine size range is as follows:

<b>Easy Sport 40</b>	<b>Easy Sport 60</b>
40 to 50 cu in 2-stroke	.60 to 90 cu in 2-stroke
.60 to .80 cu. in. 4-stroke	.70 to 1.20 cu. in 4-stroke

The **Easy Sport 40** will fly well with any of the recommended engine sizes. For "Hot Dogging" and speedy performance we suggest either an O.S. 46FX or a SuperTigre" GS-45, both 2-stroke engines. An O.S. FS-70 Surpass is a good choice for those who prefer 4-stroke engines.

For the **Easy Sport 60**, an O.S. 61 SF or a SuperTigre S-61K will have you burning holes in the sky with power to spare. If a 4-stroke engine is what you desire, the O.S. FS-91 is the perfect choice.

### Landing gear configuration

The Great Planes Easy Sport can be set up with tricycle gear (nose wheel) or built to be a taildragger. Many pilots prefer taildraggers as they are more sporty looking and offer less drag than the traditional landing gear configuration. But they can present minor ground handling problems. Tricycle gear, on the other hand, provides stable tracking during takeoff and landing, but is heavier and creates more drag than a tail wheel.

If you choose to build your **Easy Sport 40** as a taildragger, you will need to purchase a wire tail gear assembly (GPMQ1900), a 1" tail wheel (GPMQ4241) and two 3/32" wheel collars (GPMQ4302). For the **Easy Sport 60** you will need to purchase a wire tail gear assembly (GPMQ1900), a 1-1/2" tail wheel (GPMQ4243) and two 3/32" wheel collars (GPMQ4302).

# DIE-CUT DRAWINGS

Use This Diagram To Locate Die-Cut Parts For The Easy Sport 40.

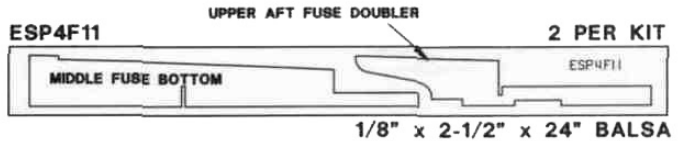
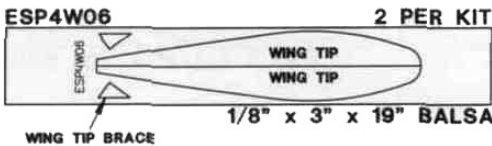
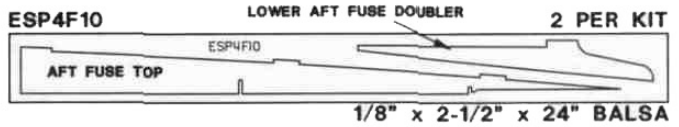
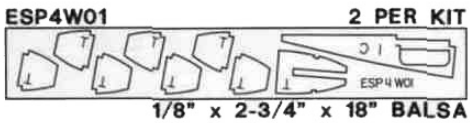
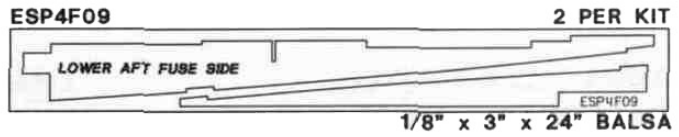
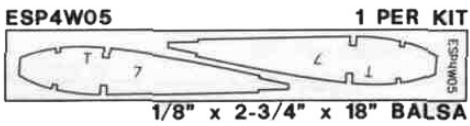
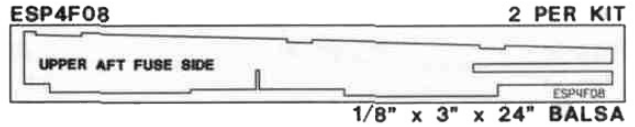
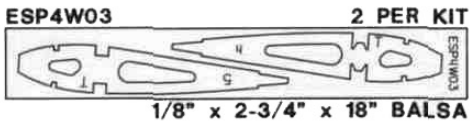
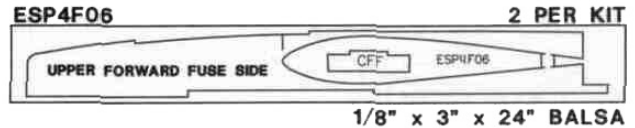
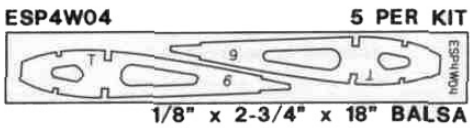
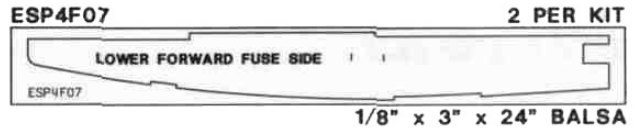
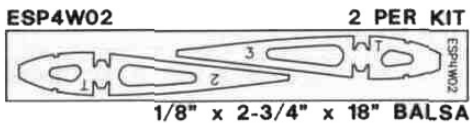
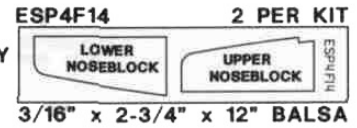
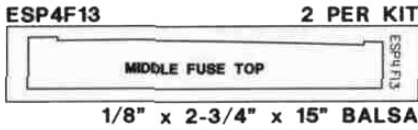
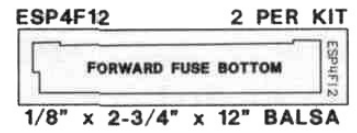
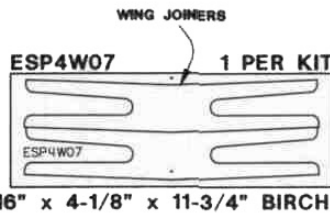
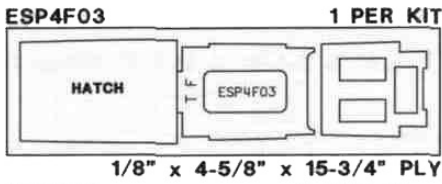
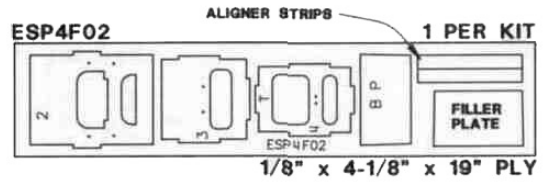
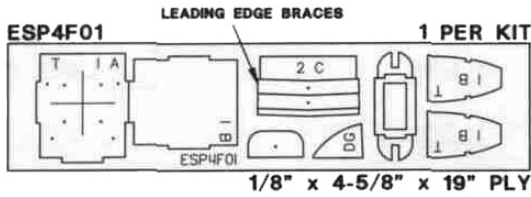
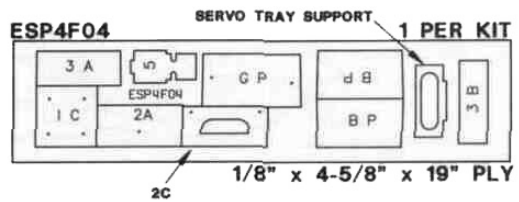
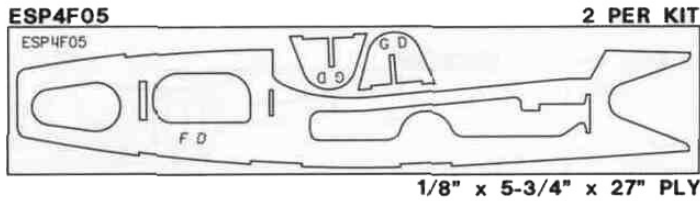

# DIE-CUT DRAWINGS

Use This Diagram To Locate Die-Cut Parts For The Easy Sport 60.

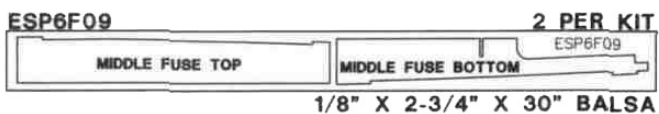
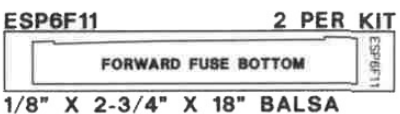
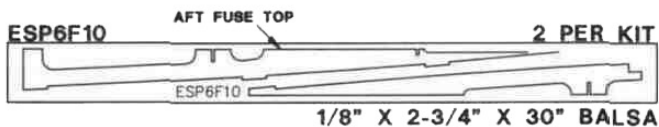
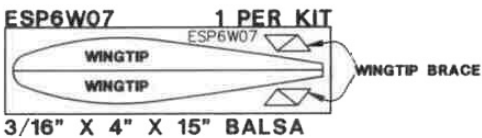
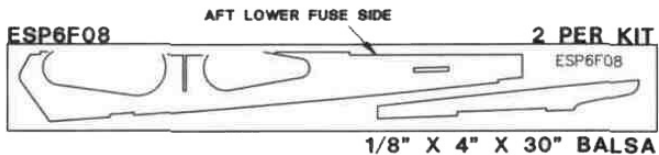
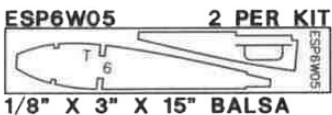
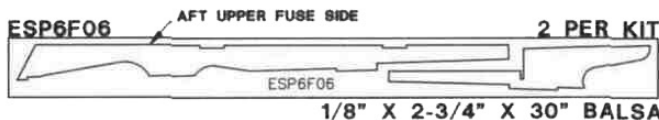
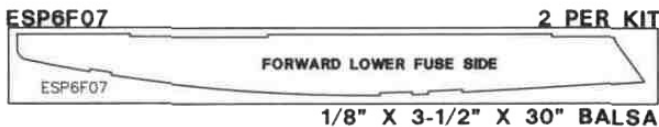
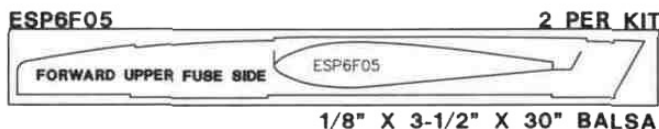
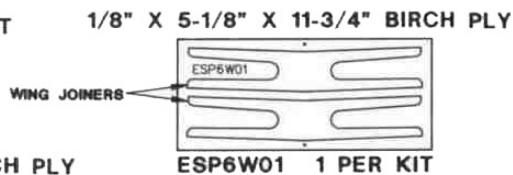
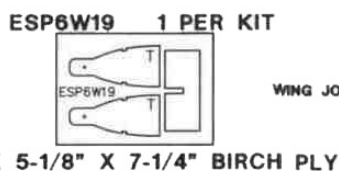
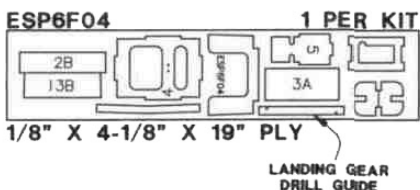
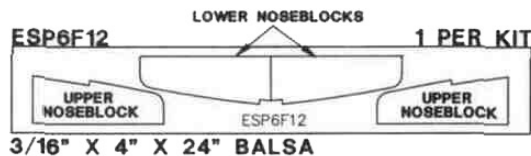
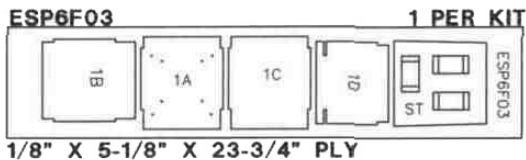
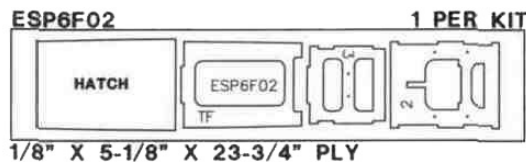
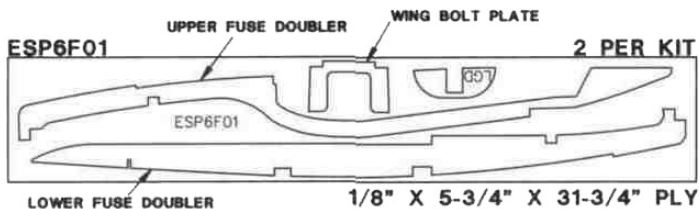

## Other items required

- D Four-channel Radio With 4 Servos
- D Engine (see page 4)
- D Glow Plug (see engine instructions)
- D Propeller (see engine instructions for sizes)
- D 1/4" Thick Foam Rubber (HCAQ1000)
- D 12" Silicone Fuel Tubing (GPMQ4131)
- Accessories Required to Complete Your Easy Sport 40
- D 2-1/2" Spinner (GPMQ4520)
- D 10oz. Fuel Tank (GPMQ4104)
- D (3) 2-1/2" Wheels (GPMQ4223)
- D Wheel Collars (2ea) 5/32" (GPMQ4306)  
(4ea)3/16"(GPMQ4308)
- D (2 rolls) Covering Top Flite MonoKote
- D Optional: Wire Tail Gear Assembly (GPMQ1900)
- D 1" Tail Wheel (GPMQ4241)
- D (2) 3/32" Wheel Collar (GPMQ4302)
- D Pilot 1-1/2" Scale
- D Great Planes Easy Sport Trim Graphics (GPMQ0405)

- Accessories Required to Complete Your Easy Sport 60
- D 2-3/4" Spinner (GPMQ4525)
- D 14oz Fuel Tank (GPMQ4106)
- D (3) 3" Wheels (GPMQ4224)
- D 3/16" Wheel Collars (6 ea) (GPMQ4308)
- D (3 rolls) Covering Top Flite MonoKote recommended
- D Optional: Wire Tail Gear Assembly (GPMQ1900)
- D 1-1/2" Tail Wheel (GPMQ4243)
- D (2) 3/32" Wheel Collar (GPMQ4302)
- D Pilot 1-1/2" Scale

## Supplies and tools needed

We recommend Great Planes Pro CA and Epoxy adhesives

- D 2oz. CA (Thin) (GPMR6003)
- D 2oz. CA+ (Medium) (GPMR6009)
- D 1oz. CA- (Thick) (GPMR6014)
- D 6-Minute Epoxy (GPMR6045)
- D 30-Minute Epoxy (GPMR6047)
- D Hand or Electric Drill

- |                    |         |          |
|--------------------|---------|----------|
| <b>Drill Bits.</b> | D 1/16" | D 5/32"  |
|                    | D 5/64" | D 3/16"  |
|                    | D 1/8"  | D 1/4"   |
|                    | D 7/64" | D 15/64" |
|                    | D 9/64" | D 19/64" |

- D Sealing Iron (TOPR2100)
- D Heat Gun (TOPR2000)
- D Hobby Saw (XACR1435)
- D #1 Hobby Knife (XACR4305)
- D #11 Blades (HCAR0311, 100qty.)
- D Razor Plane (MASR1510)
- D Pliers
- D Screwdrivers (Phillips and Flat Blade)
- D T-Pins: short (HCAR5100) and long (HCAR5200)

- D String
- D Building Square: (XACR7726)
- D Building Triangle: (XACR7725)
- D Straightedge With Scale
- D Masking Tape
- D Waxed Paper or Plastic Kitchen Wrap
- D HobbyLite" Balsa Filler (HCAR3401)
- D Petroleum Jelly
- D Easy-Touch" Bar Sander and Sandpaper see the following *Expert Tip*
- D Dremel MultiPro" or similar (Optional)
- D 1/8" x 2" Brass Tube (Optional)



In our busy workshop we use the Great Planes **Easy-Touch Bar Sanders** equipped with Great Planes #80, #150 and #220-grit **Easy-Touch Adhesive-Backed Sandpaper**. Great Planes Easy-Touch Bar Sanders are made from lightweight, rigid, extruded aluminum and can be found at most hobby shops. They are available in three sizes - 5-1/2" (GPMR6169), 11" (GPMR6170) for most general purpose sanding and 22" (GPMR6172) for long surfaces such as wing leading edges. The Easy-Touch Adhesive-Backed Sandpaper comes in 2" x 12' rolls of 80-grit (GPMR6180), 150-grit (GPMR6183) and 220-grit (GPMR6185) and an assortment to 5-1/2" long strips (GPMR6189) for the short bar sander. The adhesive-backed sandpaper is easy to apply and remove from your sanding bar when it's time for replacement.

This setup is all that is required for almost any sanding task. Custom sanding blocks can be made from balsa or hardwood blocks and sticks for sanding difficult to reach spots. We also keep some #320-grit wet-or-dry sandpaper for finish sanding just before covering.

## Preparing the work surface

To build the Easy Sport, you will need a 15" x 48" (minimum size) flat surface. Because your model will be no straighter than this surface, it is critical that it is truly flat.

The surface of the work area should be of a material that you can push pins into, such as a piece of

ceiling tile Before beginning to build, use a straight edge to check fore and aft, side to side and diagonally for warps Shim your board until it is exactly flat.

## Get ready to build

D 1 Unroll the plan sheet Reroll the plan inside out to make it lie flat.

D 2 Remove all parts from the box As you do, determine the name of each part by comparing it with the plans and the parts list included with this kit Using a felt tip or ball point pen, write the part **name** or **size** on each piece to avoid confusion later Use the die-cut patterns shown on pages 5 and 6 to identify the die-cut parts and mark them **before** removing them from the sheet Save all scraps If any of the die-cut parts are difficult to punch out, do not force them! Instead, cut around the parts with a hobby knife After punching out the die-cut parts use your bar sander to **lightly** sand the edges to remove any die-cutting irregularities

D 3 As you identify and mark the parts, separate them into groups, such as **fuse** (fuselage), **wing**, **fin**, **stab** (stabilizer) and **hardware**.

## Tail Feathers

### Build the rudder

D 1 Tape the **fuselage plan** down to your flat work surface Tape a piece of waxed paper over the fin and rudder portion of the plan

### EXPERT TIP

If you are unfamiliar with "built-up" construction, we have found that the following method is very easy and accurate.

- Position an **uncut** stick directly over the plan and pin it in place.
- Mark each side of the stick where it ends or butts with another part.
- Remove the stick from the building surface and **flip it over**. Draw a line between the marks you made previously using a straightedge.
- Using a razor saw, cut as close to the line as possible. Then, with your sanding block, true-up the ends to the line. **Flip** the part over and pin back in place over the plan.

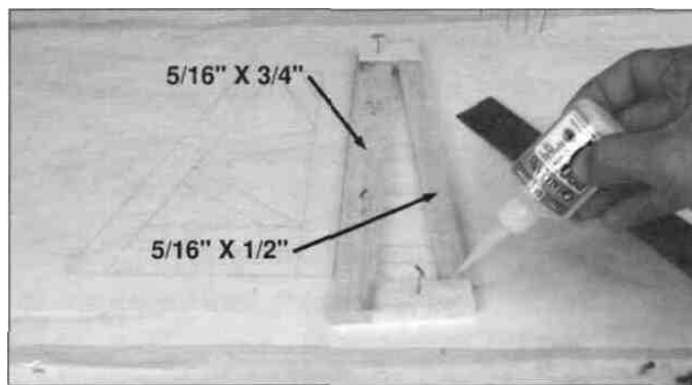

D 2 Using a razor saw, cut pieces of 5/16" x 3/4" and 5/16" x 1/2" balsa (from the 30" sticks) to make the **rudder framework**. Working right on the plan, pin these parts in place and glue them together using thin CA glue

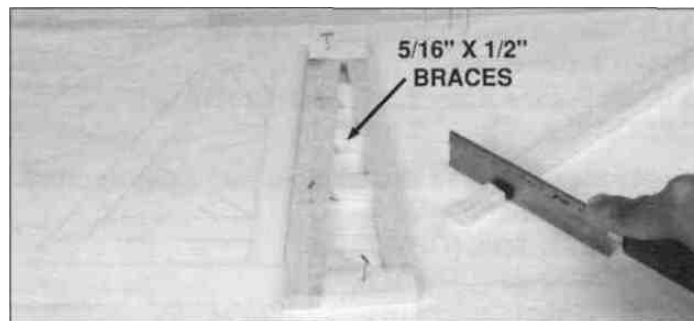

D 3 From the 5/16" x 1/2" x 30" sticks, cut braces to fit between the rudder framework and glue them in place **Note:** It is **not** necessary to get these braces in the **exact** position shown on the plan If you re building the **Easy Sport 40**, cut a 1" piece from the 5/16" x 3/4" balsa stick If you are building the **Easy Sport 60**, cut a 1-1/4" piece from the 5/16" x 3/4" balsa stick From this small piece cut the triangular **gusset** for the front bottom corner of the rudder.

D 4 Remove the rudder from your building surface Examine and add thick CA glue to any open joints Then use your sanding block with medium (150-grit) sandpaper to sand both sides of the rudder framework smooth

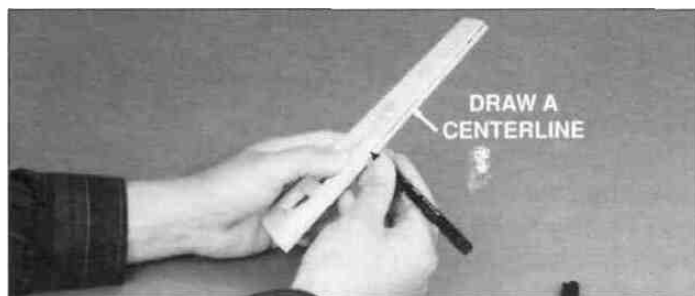

D 5 Carefully draw a **centerline** all around the edges of the rudder (this will help to maintain symmetry when sanding).



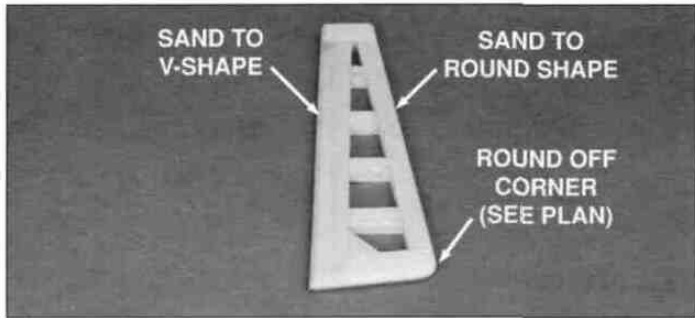

D 6 Using a sanding block and medium (150-grit) sandpaper, sand the leading edge to a "**V-shape**" as shown on the plan. Sand the bottom of the rudder to the shape as shown on the plans. Sand the trailing edges, bottom edges and top to a rounded shape.

At this point, you should have given some thought to the landing gear configuration you would like to use. If you have decided to build your Easy Sport as a taildragger, follow the simple instructions outlined in the box below. On the other hand, if you would prefer your Easy Sport with a conventional tricycle landing gear, skip the box and continue construction at Build The Fin.

Perform the following step if you are building your Easy Sport as a taildragger.

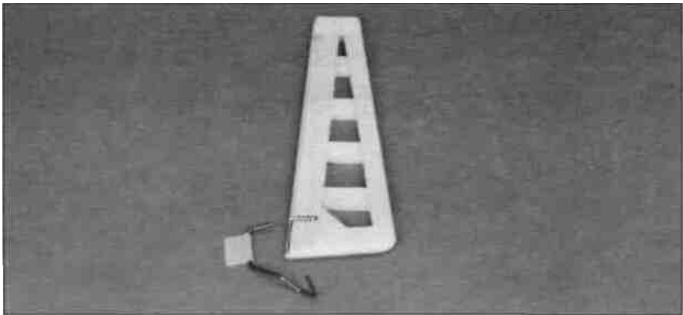
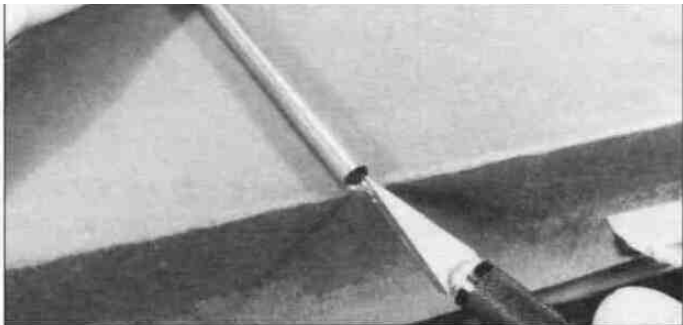

D 1 Check the plans and mark the location of the optional tailgear on the rudder. Drill a 7/64" hole in the rudder (the hole is drilled slightly oversize to allow for positioning, and to create a hard epoxy "sleeve" around the wire). Then groove the rudder leading edge to accept the tailgear wire. **HINT:** Using a hobby knife, sharpen the inside of one end of a 1/8" diameter brass tube, and use it to cut the groove in the leading edge of the rudder.

**Build the fin**

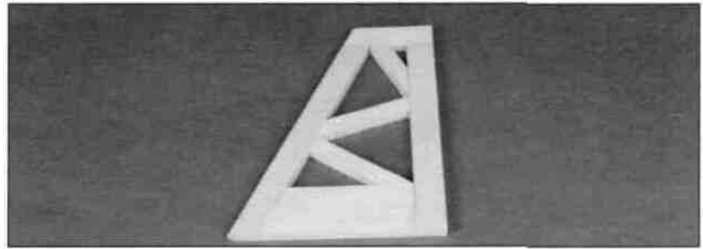

D 1 In the same manner as the rudder, build the **fin** using the 5/16" x 3/4" and 5/16" x 1/2" balsa sticks.

D 2 Carefully draw a **centerline** on the leading and trailing edges of the fin.

D 3 Sand (only) the leading edge to a round shape.

**NOTE:** The trailing edge and bottom edge must **not** be rounded or V-shaped. Instead, just sand these edges flat and square. **Do not** sand the top edge at this time.

**Build the stabilizer**

D 1 Tape waxed paper over the separate **stabilizer** drawing on the fuse plan. Pin the shaped balsa stab joiner in place directly over the plans. Then, in the same manner as the rudder, cut balsa pieces and build the stab framework.

D 2 Shape the stab tips to the shape as shown on the plan.

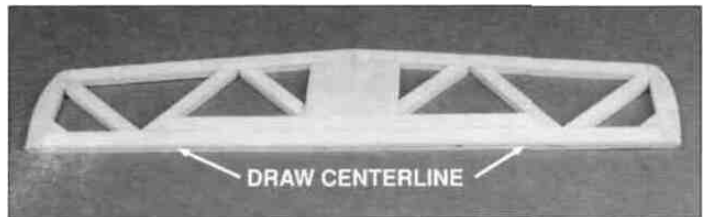

D 3 Carefully draw a centerline all around the edges of the stabilizer.

D 4 Sand the leading edge and tip to a round shape. **NOTE:** The trailing edge must not be rounded or V-shaped. Instead, just sand this edge **flat** and **square**.

## Build the elevators

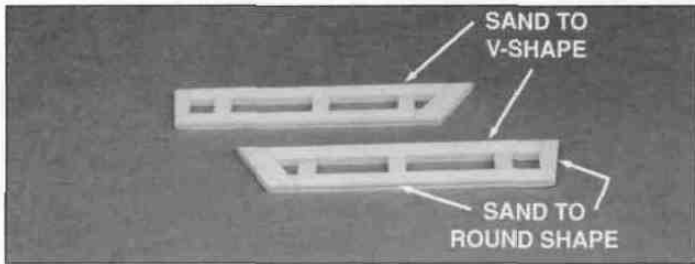

D 1 In the same manner **as** the rudder, build each **elevator** using the 5/16" x 3/4" and 5/16" x 1/2" balsa sticks

D 2. Shape the elevator tips to the shape as shown on the plan.

D 3. Carefully draw a **centerline** all around the edges of the elevators.

D 4. Sand the leading edge to a "V-shape. Sand the trailing edge and the outside edge of the tip to a round shape as shown on the plans.

## Join the elevators

D 1 Temporarily pin the elevators and stab over their respective drawings on the plan

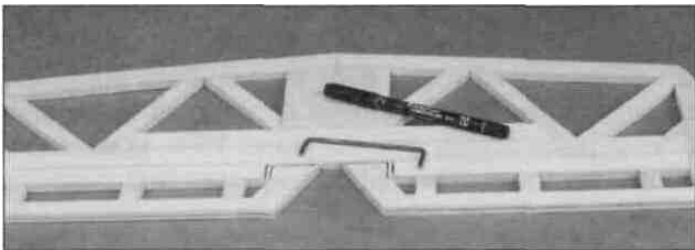

D 2. Lay the 1/8" wire **elevator joiner** in place on the elevators and mark its outline using a fine point felt-tip pen

D 3 Accurately drill holes in the elevators for the 1/8" wire joiner. Begin by drilling a 1/16" or 5/64" pilot hole. Then drill the final hole to a depth of 7/8" with a **9/64"** drill bit. (The hole is drilled slightly oversize to allow for positioning, and to create a hard epoxy "sleeve" around the wire)

D 4 Use the sharpened 1/8" diameter brass tube or a drill bit to cut a groove in the leading edge of the elevators to accept the joiner wire.

D 5 Roughen the joiner wire with coarse sandpaper, then clean the wire thoroughly with alcohol to remove any oily residue.

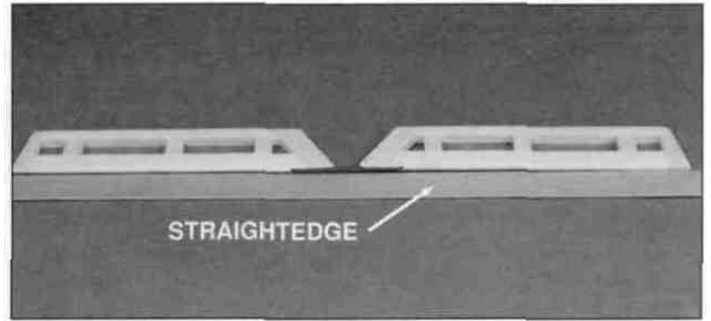

D 6 **Trial fit** the joiner wire into the elevators. Then glue it in using 6-minute or 30-minute epoxy. When gluing, lay the elevators on a flat surface, with the leading edges along a straightedge to insure perfect alignment. Cover the top of the joined elevators with a sheet of waxed paper. Then lay a flat, heavy object on top. A telephone book works well. This will insure a true, flat elevator assembly when the epoxy cures.

## Install the hinges

(Do not glue)

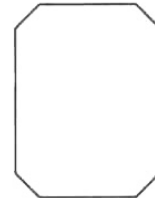

D 1. Cut 18 hinges (3/4" x 1") from the 2" x 9" CA hinge strip. Trim the corners at a 45 degree angle to make insertion easier.

D 2 Lay the rudder and elevators on the plan and mark the **hinge locations**. Place the rudder against the fin TE and transfer the marks to the fin. Place the elevators against the stab TE and transfer the marks to the stab.

**CAUTION: You must use extreme care when cutting hinge slots with a hobby knife, to avoid cutting yourself! If the balsa part breaks while you are pushing on the knife, the blade could go into your hand before you know it! A good precaution is to wear leather gloves while performing the following steps, and always cut away from yourself.**

D 3. Cut the hinge slots **on the accurate centerlines which you previously drew**, using a hobby knife or a slotting fork and slotting hook. (The recommended hinge slotting technique is explained on the next page.)



## INSTALLING CA HINGES

The hinge material supplied in this kit consists of a 3-layer lamination of mylar and polyester. It is specially made for the purpose of hinging model airplane control surfaces. Properly installed, this type of hinge provides the best combination of strength, durability and ease of installation. We trust even our best show models to these hinges, but **it is essential to install them correctly**. Please read the following instructions and follow them carefully to obtain the best results. These instructions may be used to effectively install **any** of the various brands of CA hinges.

The most common mistake made by modelers when installing this type of hinge is not applying a sufficient amount of glue to fully secure the hinge over its entire surface area, or, the hinge slots are very tight, restricting the flow of CA to the back of the hinges. This results in hinges that are only "tack glued" approximately 1/8" to 1/4" into the hinge slots. The following technique has been developed to help ensure thorough and secure gluing.

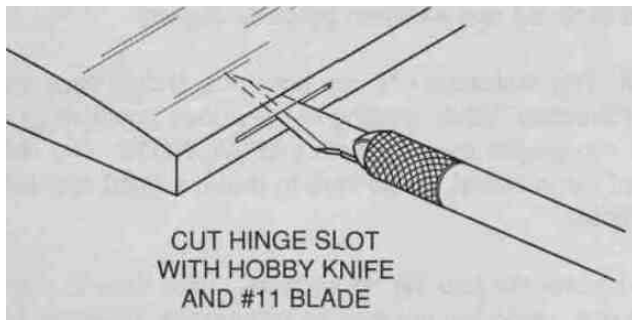

A. Cut the hinge slot using a #11 blade in a standard #1 knife handle. The CA hinges provided have a thickness that fits this type of slot very well. Trial fit the hinge into the slot. If the hinge does not slide in easily, work the knife blade back and forth in the slot a few times to provide more clearance (it is really the **back edge** of the blade that does the work here in widening the slot).



B. **Drill a 3/32" hole, 1/2" deep, in the center of the hinge slot.** If you use a Dremel MultiPro for this task, it will result in a cleaner hole than if you use a slower speed

power or hand drill. Drilling the hole will twist some of the wood fibers into the slot, making it difficult to insert the hinge, so you should reinsert the knife blade, working it back and forth a few times to clean out the slot.

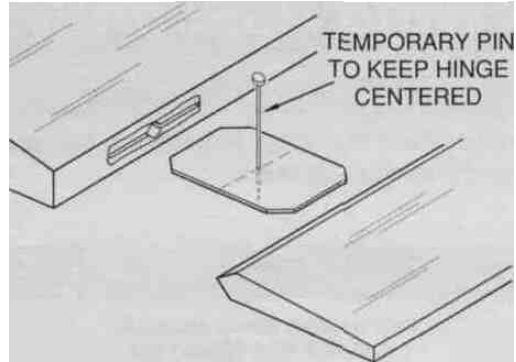

**Note:** When hinging the rudder and elevator which use torque rods, use a toothpick to force epoxy down the hole drilled for the torque rod. In the case of the rudder, be sure not to let glue get into the bearing tube.

C. Insert the hinges and install the control surface. Verify the left-right positioning of the control surface and close up the hinge gap to 1/32" or less. It is best to leave a very slight hinge gap, rather than closing it up tight, to help prevent the CA from wicking along the hinge line. Make sure the control surface will deflect to the recommended throws without binding. If you have cut your hinge slots too deep, the hinges may slide in too far, leaving only a small portion of the hinge in the control surface. To avoid this, you may **insert a small pin** through the center of each hinge before installing. This pin will keep the hinge centered while installing the control surface. Remove the pins before proceeding.

ASSEMBLE THEN APPLY 6 DROPS OF THIN CA TO CENTER OF HINGE, ON BOTH SIDES

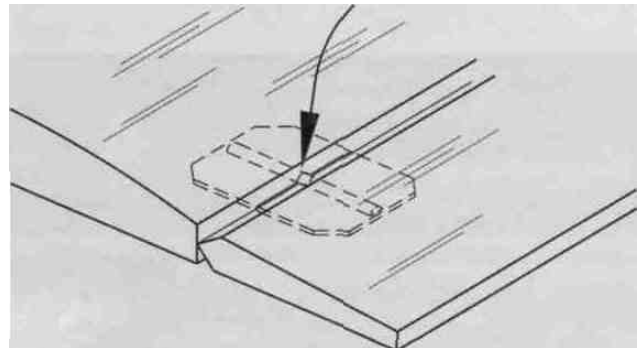

D 4 Apply **6 drops** of thin CA adhesive to **both sides of each hinge on the elevators and rudder only - not the ailerons yet.** Allow a few seconds between drops for the CA to wick into the slot. Note that the small "tunnels" you created by drilling the 3/32" holes allow the CA to freely travel in to the entire surface of the hinge, producing an extremely secure bond.

D 4 Insert the hinges into the slots and trial fit the rudder and elevators in place on the fin and stab **Do not glue the hinges until after you have covered the model.**

# Wing Assembly

## Prepare wing parts

Before assembling the wing there are a few preliminary assemblies that must be made.

## Spars

TWO WARPED SPARS INSTALLED THIS WAY WILL RESULT IN A STRAIGHT WING



TWO WARPED SPARS INSTALLED THIS WAY WILL RESULT IN A WARPED WING



D 1 Before using the basswood spars examine them carefully for possible imperfections. Look for knots, soft spots, diagonal grain and any other imperfections. If possible, position each spar so the imperfections (if any) are on the outer half of the wing panel (towards the tip) where they will be less affected by high stress. If the spars are warped slightly, try to "balance them out" by installing the warped spars in opposite directions (see sketch) **NOTICE:** If you feel that any of the wing parts are unusable due to severe warps or other defects, give us a call and we'll replace the parts.

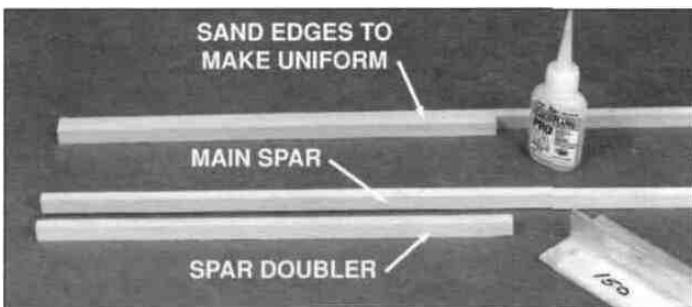

D 2 Glue a 1/4" x 3/8" x 9-78" (1/4" x 1/2" x 10" for the Easy Sport 60) basswood **spar doubler** to a 1/4" x 3/8" x 30" (1/4" x 1/2" x 32" for the Easy Sport 60) basswood **main spar** with medium CA as shown. Sand the edges of the spars to remove any excess glue and to make the edges uniform. Make **four** spar assemblies. Refer to the cross-section for orientation.

## Ribs

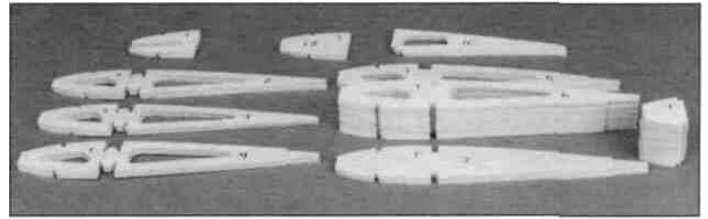

D 1 Carefully punch out all the die-cut balsa **wing ribs**. Sand the edges **slightly** to remove any die cutting irregularities and arrange them into stacks of the same kind of ribs.

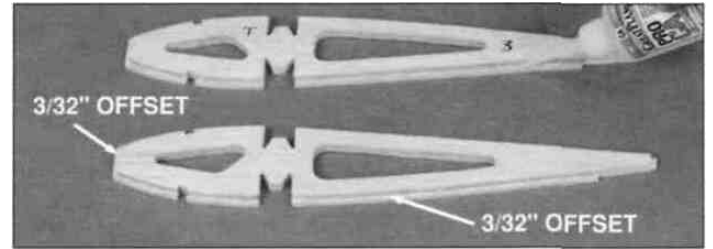

D 2 Locate the two #3 and #4 ribs. Center one #3 rib on one #4 rib using the lightening holes as a reference. There will be a 3/32" offset between the edges of rib #3 and #4 when properly aligned.

**NOTE:** The embossed "T" on both ribs should face the same direction. While holding in the above position, glue these two pieces together with thin CA. **NOTE:** The ribs are not symmetrical, so be sure to **make a right and left** assembly.

D 3 Locate the two 1A rib sections. Take care to align these ribs using the notches as references. Glue the 1A ribs together with thin CA for the **Easy Sport 40**. Glue the 1A ribs together with **6-minute epoxy** for the **Easy Sport 60**.



D 4 Locate and align the two 1C ribs as described above and glue them together with thin CA.

## Leading & trailing edges

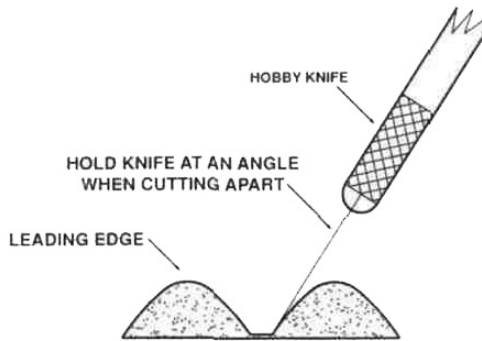

D D 2. Lay one of the 3/32" x 1-3/4" x 30" (3/32" x 2" x 32" for the Easy Sport 60) balsa **TE sheets** on the wing plan, lining it up with the outside edge of the tip rib. Pin in place. Any excess balsa will extend beyond the wing centerline.

D D 3. Place a basswood **main spar** on the plan, lining up the outboard end of the spar doubler with the plan. The main spar will extend beyond the root and tip. This will be trimmed off later. **Do not** pin this spar down to the plan - just use pieces of masking tape on the ends, to prevent it from moving.

### THIS STEP FOR EASY SPORT 40 ONLY

D Locate both die-cut 1/8" ply leading edge joiners (if necessary, refer to the die-cut patterns on page 6). Drill a 1/8" hole at the punch mark. Then, follow through again with a 1/4" drill.

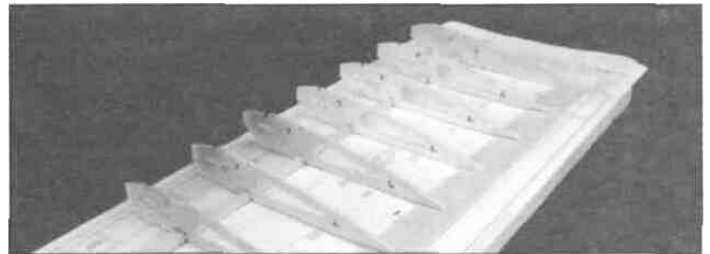

D D 4. Place the #5, #6 and #7 ribs (#4, #5 and #6 ribs for the Easy Sport 60) onto the main spar. Remember: The stamped "T" denotes the top of the rib.

## Build the wing panels

**READ THIS BEFORE YOU BEGIN BUILDING THE WING PANELS:** It is very important that you build a straight wing with no warps or twists or you will get some flying characteristics you didn't expect' Be very careful when you align the ribs, spars, leading edges, trailing edges and sheeting in the following steps. All of these parts should be in their correct positions before you glue them in place. Hold or pin the parts in place, then glue. The following instructions will guide you through the building of a straight, warp-free wing.

**NOTE:** You will build the right wing panel first (steps 1 through 17). Then follow steps 2 through 16 again to build the left wing panel.

**VERY IMPORTANT:** The ribs are stamped with a "T" which always denotes the top of the rib.

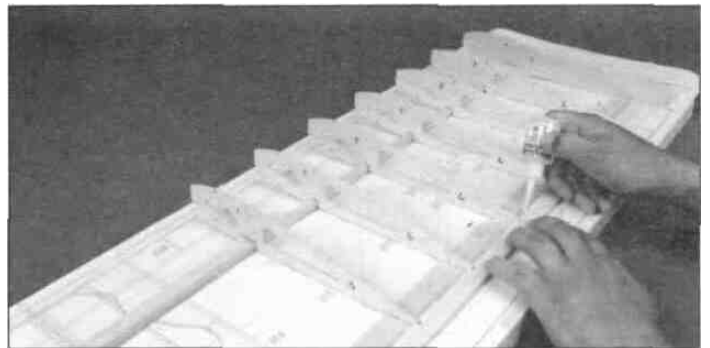

D D 5. Now, place one of the **shaped and notched balsa TE'S** on the TE sheet (the end with the closely spaced notches must be at the wing root). **Note:** The TE is not symmetrical - refer to the cross-section for proper orientation. Work the TE onto the back of the ribs starting at rib #7 and working towards rib #5 (start at rib #6 and work toward rib # 4 on the Easy Sport 60). The TE sheet may overhang the shaped and notched TE slightly. This is not a major concern because any excess will be sanded off later. Make sure that ribs are inserted all the way into the TE notches and touching the TE sheet. Glue the shaped TE and ribs to the TE sheet with thin CA.

D 1. Tape the wing plan to your flat building surface so that the **Right Wing Panel** is facing you. Tape a sheet of waxed paper or plastic kitchen wrap over the right wing panel drawing.

**NOTE:** Do not be too concerned if the ribs do not line up exactly with the plan. Sometimes the humidity will cause the plan to expand or contract. Just remember to line up the leading edge, trailing edge and ribs with the outside edge of rib #7 (rib #6 on the Easy Sport 60). Let the pre-cut notches take care of the spacing.

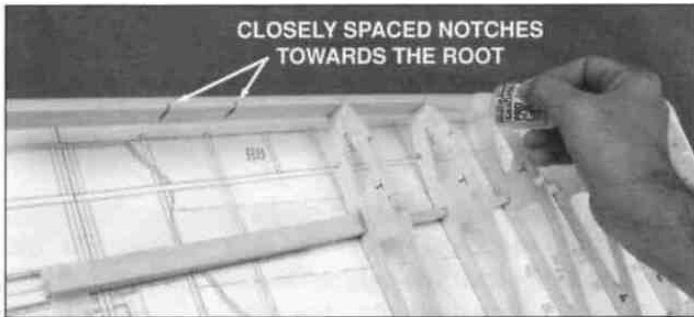

D D 6. Place the **shaped and notched LE** on the front of the ribs. Once again, the end with the closely spaced notches must face the wing root. Center the LE vertically on the ribs, so the top and bottom edges of the ribs are flush with the shaped LE. When certain that the shaped LE is centered and in position, glue it to the ribs with thin CA.

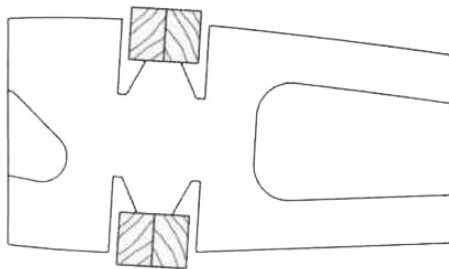
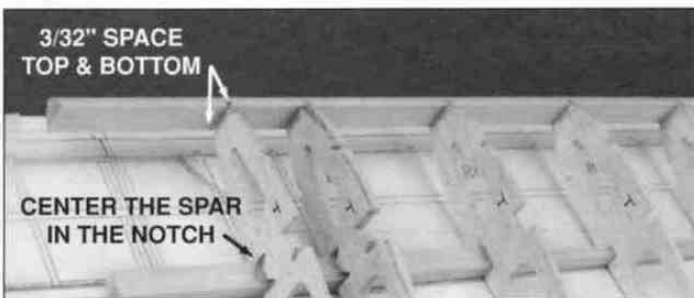

D D 7. Put ribs #2, #3 and #4 in place on the main spar. Note that the spar notches are cut extra wide to allow for the wing joiners. Refer to the sketch and note that it is most important to center the rib fore and aft, providing equal space in front of and behind the spar. Insert the ribs into their notches in the shaped LE and TE. Center the ribs vertically on the LE (rib #2 will have a 3/32" space on top and bottom when properly centered). Glue both ribs to the shaped LE, TE sheet and shaped TE with thin CA.



D D 8. Insert the upper main spar and a **3/16" x 3/16" x 30" balsa front spar** (3/16" x 3/16" x 32" basswood front spar on the Easy Sport 60) into the notches in the tops of the ribs. The upper main spar should be aligned directly over the lower main spar. The upper front spar should be flush with the outer edge of rib #7 (rib #6 on the Easy Sport 60). Do not trim off any excess material from the main or front spars yet.

D D 9. Make sure all ribs are vertical (90 degrees to the work surface), that the spars are lined up and that all parts are properly aligned. Glue the ribs to the upper, lower and front spars with thin CA.



D D 10. With medium CA, glue the pre-cut 1/16" x 1-3/4" x 3-3/8" (3/32" x 2" x 3" on the Easy Sport 60) balsa **shear webs** to the back of the main spars from rib #5 thru #7 (rib #4 thru #6 on the Easy Sport 60) as shown on the plans. It is not necessary for the webs to be glued to the ribs.

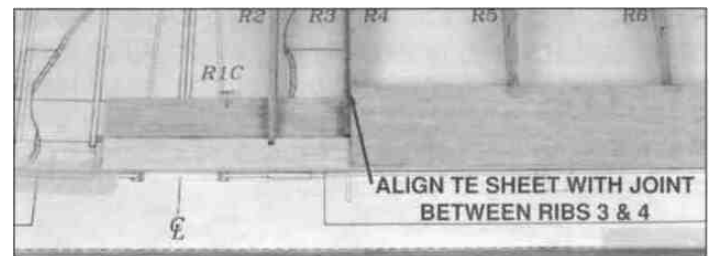

D D 11. Position one of the **TE sheets** on top of the shaped TE so one end is even with the joint between ribs #3-4 and glue it in place. **NOTE:** To get a good glue joint you should properly position the TE sheeting and apply thin CA where it joins each rib. Second, apply thin CA along the rear edge where the sheeting meets the small edge of the shaped TE. Finally, unpin and remove the wing from the building surface. Stand the wing up so the LE is up and the TE is down and drip a couple of drops of thin CA into the joint where the sheeting meets the wide edge of the tapered TE.

## STEPS 12 & 13 FOR EASY SPORT 40 ONLY

D D 12. Turn the wing panel upside down and install a **front spar** on the bottom of the wing. Glue in place with thin **CA**.



D D 13. Turn the wing right side up and glue the **#8 ribs** in place with medium **CA**. Use the plan as a guide for positioning the ribs.

D D 14. Now, go over the entire wing panel making sure **all** joints are securely glued. Add thin and/or thick **CA** glue where necessary. Make sure that you double glue the shear webs with medium **CA**.

D D 15. Using a razor saw, carefully cut off all excess sheeting, spars, LE and TE even with the outboard edge of rib #7 (rib #6 on the Easy Sport 60). Now, sand the ends flush with the face of the rib.

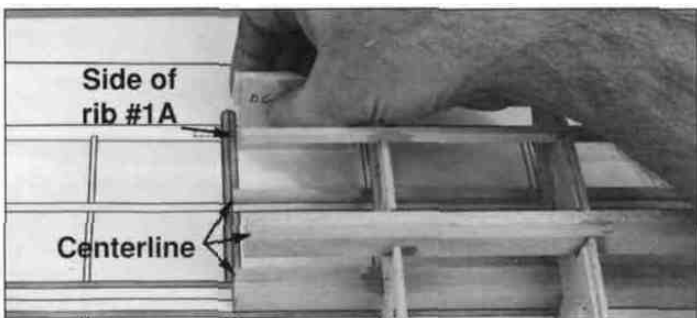
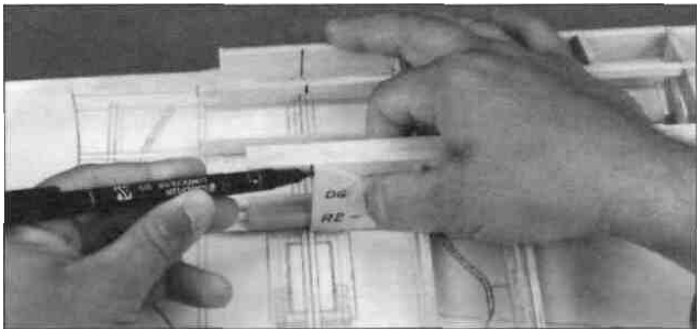

D D 16. Temporarily pin the wing half back over the plan. On the **Easy Sport 40**, place the dihedral gauge (**DG**) on the centerline as shown and mark the LE, front spars, main spars, TE sheeting and TE. On the **Easy Sport 60**, place the dihedral gauge on the centerline as shown and mark the front spars, main spars, TE sheeting and TE. Mark the LE at the side of **rib #1A**.

**NOTE:** Make sure that the **DG** is facing the proper direction. Remove the wing from the building surface and using a razor saw, carefully cut off all excess sheeting, spars, LE and TE even with the lines you just drew. Now, sand the ends of the parts you just trimmed until they are smooth and flush with the lines.

D 17. Turn the wing plan around so the **Left Wing Panel** is facing you. Cover it with waxed paper and build the left wing panel in the same manner as the right panel, following steps 2-16.

## Join the wing panels

D 1. Locate the two 1/16" (1/8" on the Easy Sport 60) birch ply **wing joiners**. **Before** you remove them from the die-cut sheet, draw a line connecting the two punch marks using a pencil and straightedge. Be sure to mark **both** sides.

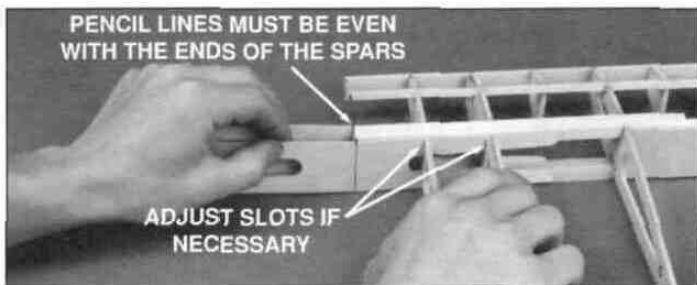

D 2. Starting with the **right** wing panel, test fit the wing joiners to the front and rear of the main spar. The wing joiners must slide far enough so that the pencil marks line up with the ends of the spar.

**NOTE:** You may need to adjust the pre-cut slots **to** provide enough clearance for the wing joiner to slide.

## STEPS 3 & 4 FOR EASY SPORT 60 ONLY

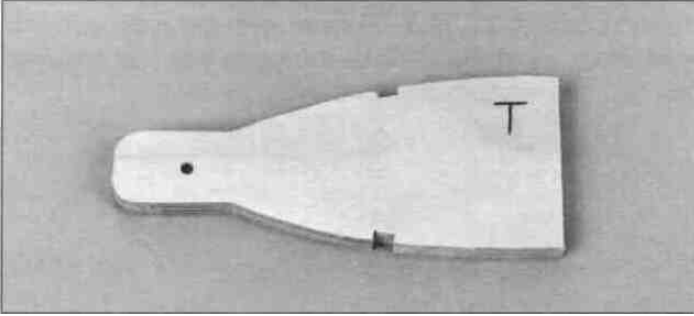

D 3. Drill a 1/8" hole at the punch mark on rib #1A.

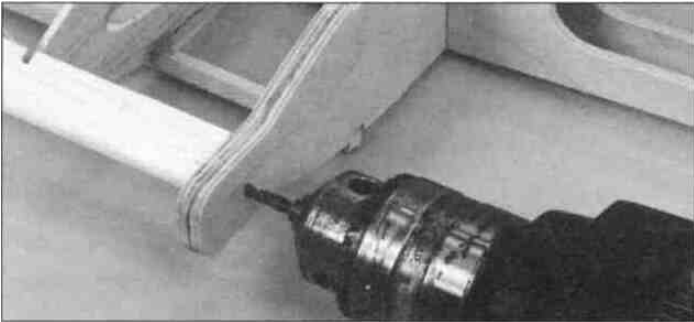

D 4. Center rib #1A against the LE and on the line drawn on the 1/8" ply wing joiner. Make sure that rib #1A is centered between the edges of the ply wing joiner. Using the hole through rib #1A as a guide, drill a 1/8" hole, perpendicular to rib #1A, 5/8" deep into the LE.

D 5. Starting at step 2, repeat for the left wing panel.

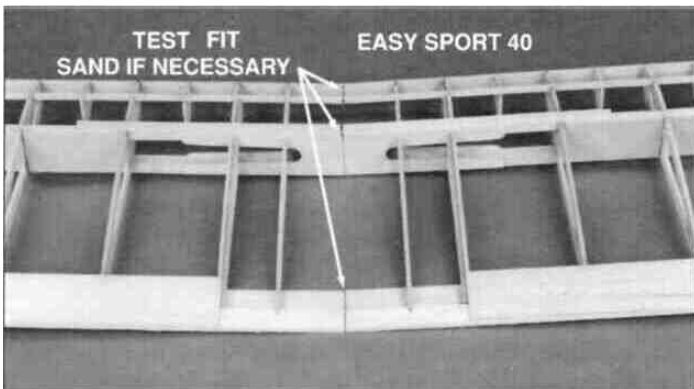

D 6. On the **Easy Sport 60**, align rib #1A on the right wing panel and insert the 1/8" x 1" alignment dowel through rib #1A and into the LE. At this point test fit the left and right wing panels together "dry" (NO GLUE) on the Easy Sport 40 and 60. With the center of the wing resting on the work surface, block up both wing tips 1" (1-7/64" on the Easy Sport 60) as measured from the work surface to the bottom of rib #7 (rib #6 on the Easy Sport 60). Check the fit of the LE, spars and TE to make sure they meet up nicely without any gaps or sweep in the wing.

**NOTE:** Take your time to make sure that this procedure is done accurately. A little extra work and attention to detail here will insure a strong, straight wing.

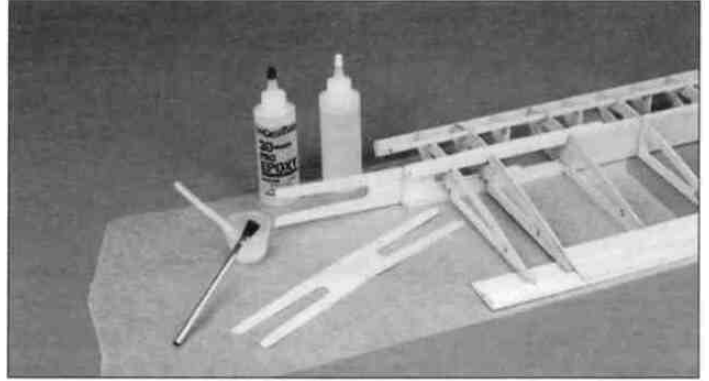

D 7. **IMPORTANT: Do not use epoxy with a working time of less than 30 minutes for this step!** Place waxed paper on the work surface and mix up some epoxy. On the **Easy Sport 40**, apply it to the spar joiners, spar ends and the ends of both leading and trailing edges. On the **Easy Sport 60**, apply epoxy to the spar joiners, spar ends, the ends of both leading and trailing edges, the 1/8" hole in the leading edges and the aft edge of rib #1 A where it contacts the ply wing joiner.

On both the Easy Sport 40 and 60, slide the spar joiners into the right wing panel first. Slide the left wing panel into place and wipe off any excess epoxy. **Immediately proceed to the next step.**

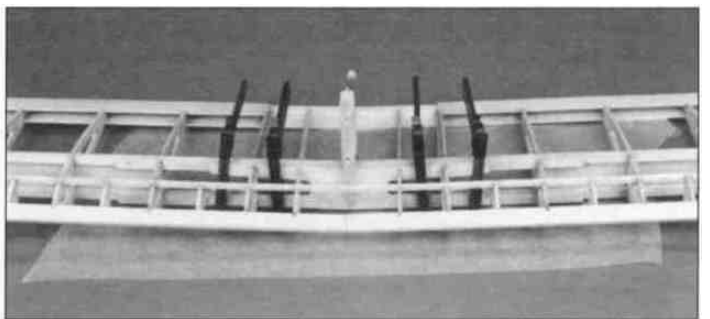

D 8. Block up the tips of both wing panels 1" on the Easy Sport 40 (1-7/64" on the Easy Sport 60) as measured from the work surface to the bottom of rib #7 (rib #6 on the Easy Sport 60). Carefully align the spars, LE and TE of both wing panels. Clamp the spar joiners to the spars and wipe off any excess epoxy with a paper towel. **Allow the epoxy to fully cure before disturbing the wing and removing the clamps.**



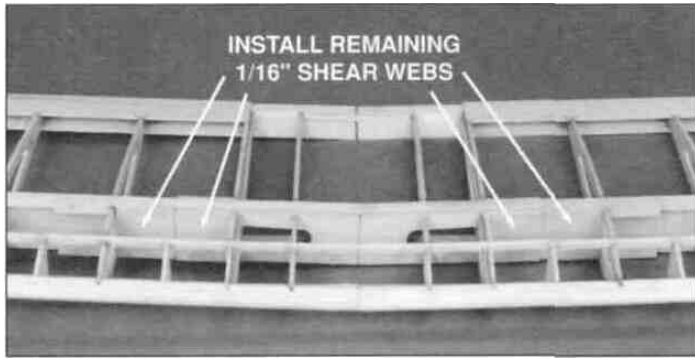

D 9. Securely glue the remaining balsa shear webs to the front and back sides of the spar joiners between ribs #4 and #5 (ribs #2 and #3 for Easy Sport 60). Trim the shear webs so that they do not protrude above or below the spar joiner where they will interfere with the center sheeting applied in a later step.

D 10. Glue the die-cut 1/8" ply **TE Brace** in place between the #2 ribs as shown on the plan.

If you are building the **Easy Sport 60**, skip to step 6 under **Install the center ribs and sheeting**.

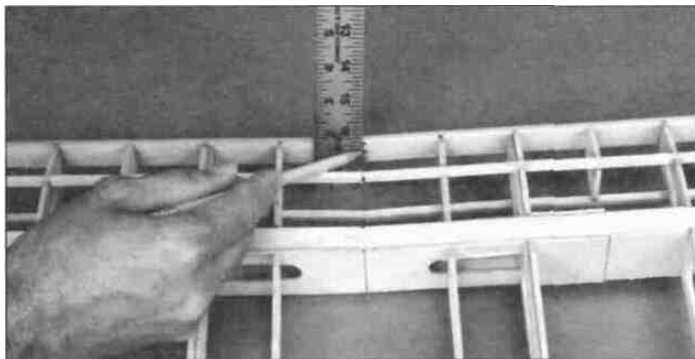

D 11. With a pencil, mark the **back** of the LE center joint: 3/32" and 3/8" down from the top of the LE. Also, 3/32" up from the bottom of the LE. See photo.

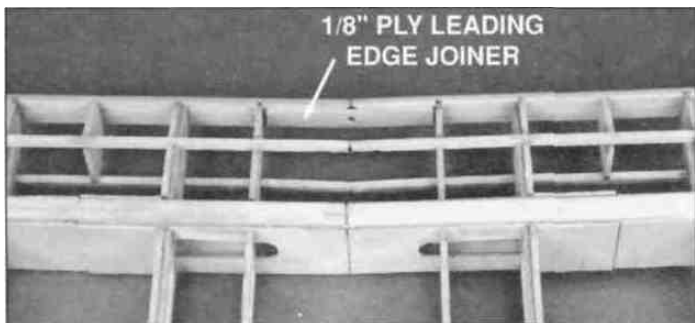

D 12. Center a die-cut 1/8" ply **leading** edge joiner on the back of the LE center joint. Use the marks drawn in the previous step to aid in alignment. Glue in place with thin CA.

## Install the center ribs and sheeting

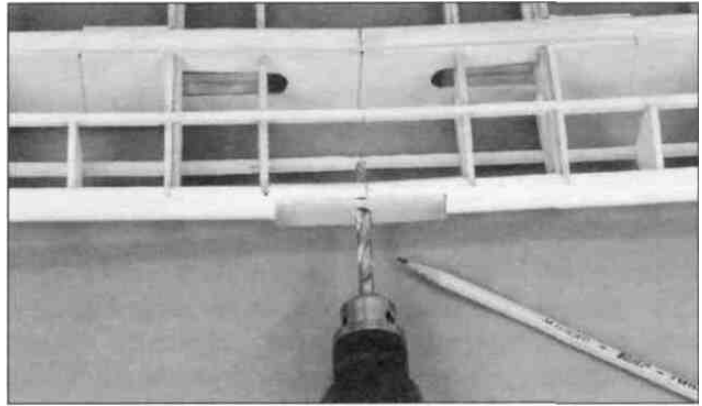

D 1. Mark the center of the front LE joint with a pencil. Vertically center the remaining LE joiner on the mark and **tack-glue** in place. Then, using both LE joiners as guides, drill through the front LE joiner, shaped LE and back LE joiner with a 1/4" drill. **Remove only the LE joiner that is tack-glued to the front of the LE.**

D 2. Round both ends of the pre-cut, 3" long **wing dowel** with medium (150-grit) sandpaper.

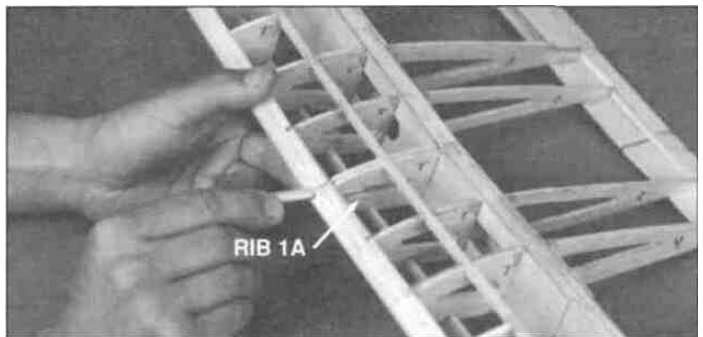

D 3. Install the previously laminated **1A ribs** as shown on the plans (**do not glue yet.**) Slide the wing dowel through the LE and all the way into the slot in rib 1A.

D 4. Align the 1A ribs and the wing dowel so that the wing dowel is flush with the outside edges of the slot in 1A. Glue 1A to the LE and forward spar joiner with medium CA. Be careful not to glue in the wing dowel.

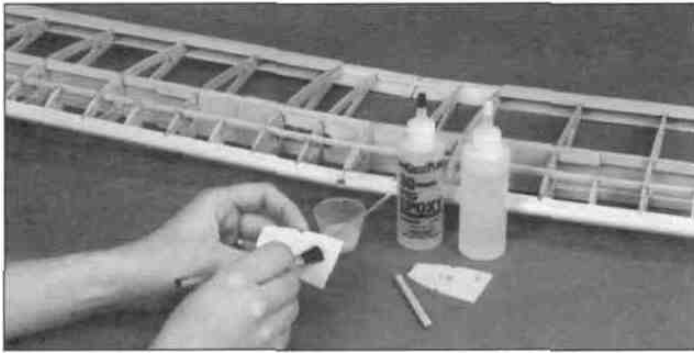

D 5. Remove the wing dowel from the wing. Mix up a batch of 30-minute epoxy. Apply the epoxy to the inboard side of both die-cut 1/8" ply **1B ribs**. Install the 1B ribs as shown on the plans, lining them up with the 1A ribs (Remember: the embossed "T" identifies the top of the rib). Quickly pack some epoxy into the wing dowel hole in the LE and insert the wing dowel all the way into the wing dowel hole. Clamp the 1A and 1B ribs together. Do not disturb the wing until the epoxy has fully cured.

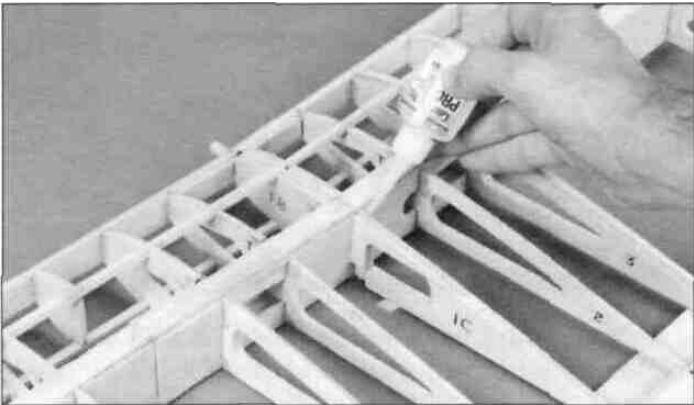
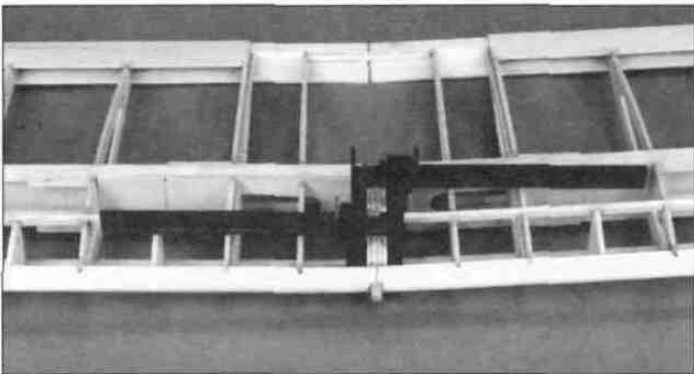

D 6. Locate the previously laminated **1C ribs**. Slide 1C into position between the aft spar joiner and the TE brace as shown. You may have to trim 1C to length for it to properly slide into place. Maintain a 3/32" gap between the bottom edge of the rib and the work surface to allow for the center sheeting which will be installed later. Use a leftover piece of 3/32" balsa to hold the rib up off the work surface during this step. Hold in this position and glue in place with thin CA.

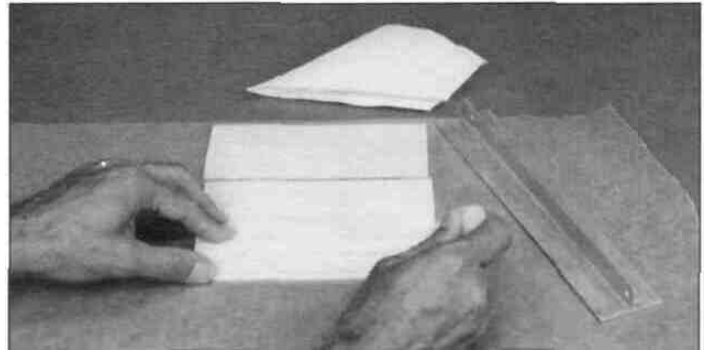

D 7 If you are building the **Easy Sport 40**, edge glue (procedure described below) two of the 3/32"x 3" x 7-1/4" and the 3/32" x 1-3/4" x 7-1/4" balsa center sheeting pieces together using thin CA. This assembly is now the **top center sheet**. Glue the remaining two 3/32" x 3" x 7-1/4" balsa sheets together in the same manner. This assembly is now the **bottom center sheet**.

If you are building the **Easy Sport 60**, locate the five 3/32" x 3" x 24" balsa sheets. From these sheets, cut **ten** pieces 10-7/8" long. Cut one of these pieces 2-3/4" wide and another one 5/8" wide. Edge glue (procedure described below) two of the 3/32" x 3" x 10-7/8" and the 3/32" x 2-3/4" x 10-7/8" balsa sheeting pieces together using thin CA. This assembly is the **top center sheet**. Edge glue the remaining two 3/32"x 3" x 10-7/8" and the 3/32" x 5/8" x 10-7/8" balsa sheeting pieces together using thin CA. This assembly is the **bottom center sheet**.

**EXPERT TIP**

**Joining Sheeting:**  
 When joining sheets of balsa together, you must work over a piece of waxed paper or plastic kitchen wrap. Also, it often helps to have a piece of **paper towel** handy on the workbench. Hold the pieces of wood together to check the fit. If there are any gaps between the sheets, lightly sand the edges of the sheets with medium (150 grit) sandpaper until they fit together well. Hold the sheets together in position and sparingly apply a straight line of thin CA to the joint. Immediately wipe the excess glue off the joint with the paper towel. Sand both sides of the joined sheeting with a sanding block using fine (220 grit) sandpaper to smooth out the glue joints.

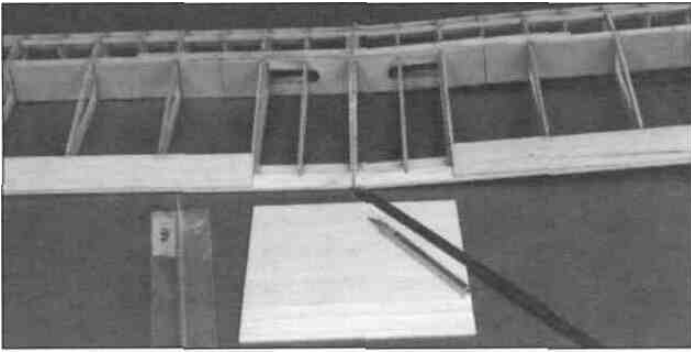

Lt 8. Fit the top center sheet in place on the top of the wing. Its position is aft of the main spar. Trim or sand, if required, for a good fit. The sheet should fit into the rails created at the joint of ribs #3 and #4. **Do not glue.** Repeat this step to fit the bottom center sheet.



D 9. Place the top center sheet into position. Turn the wing over so that the bottom is facing up. With moderate finger pressure, squeeze the sheet so that it contacts the top of rib #1C. Holding it in this position, glue the center sheet to rib #1C with thin CA. Work the pressure evenly along 1C so that there are no gaps while gluing. In the same manner, glue the center sheeting to the #2 and #3 ribs. Now, examine all center section joints and apply medium or thick CA to any questionable areas.

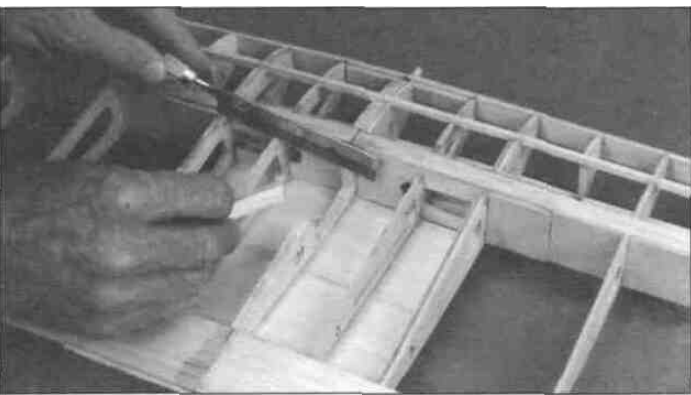

D 10. Using a hobby saw or knife, remove the partially cut brace from rib #1C. At this point test fit one of your servos into the pocket just created. If it fits, great! If not, now is the time to enlarge the cutout. This is most easily accomplished with either a hobby saw or a Dremel MultiPro.

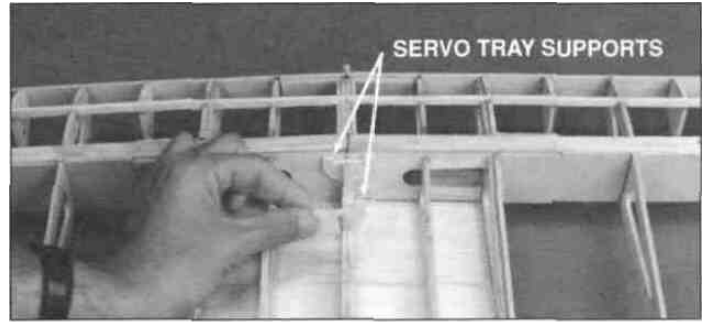

D 11. Slide the two die-cut ply **aileron servo tray supports** in place. **Do not glue** them in yet.



D 12. Install the die-cut ply **aileron servo tray** in place on top of the aileron servo tray supports. When everything is in position, glue the servo tray supports and servo tray in place with thin CA.



D 13. Test fit the bottom center sheet one last time. The bottom sheeting will be installed directly over the servo tray. Remove the sheet and apply thick CA to the ribs and servo tray. Press the sheeting down and hold it in place until the glue sets.

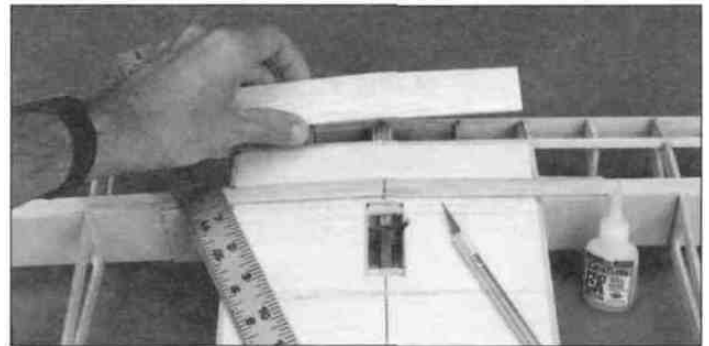
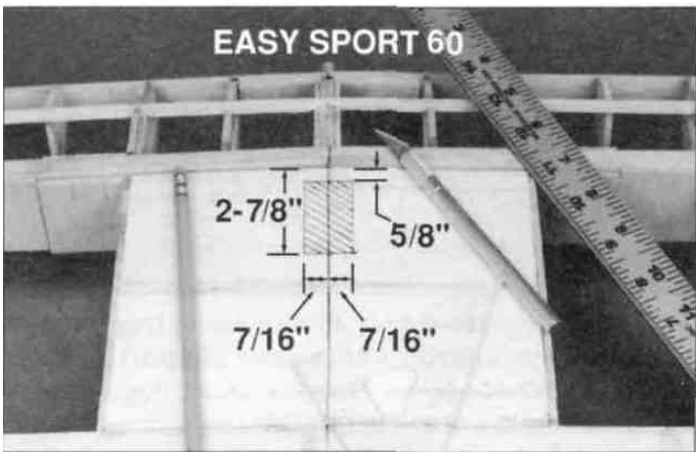
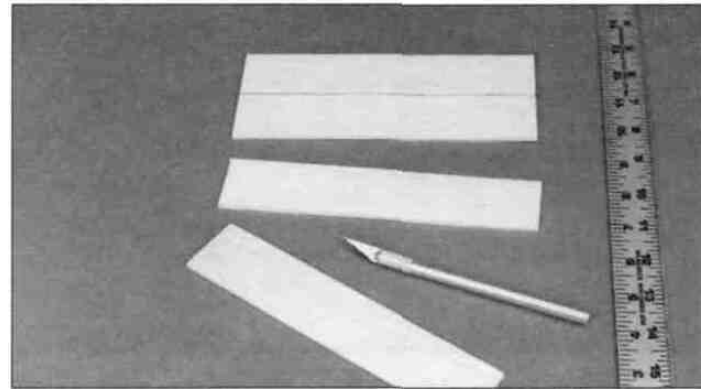
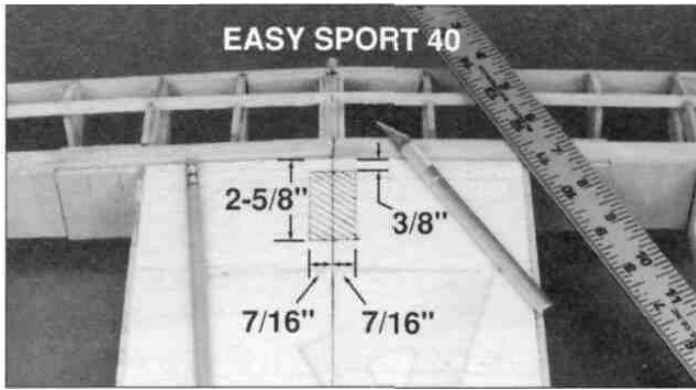

D 15 On the **Easy Sport 40**, cut the remaining  $3/32" \times 3" \times 7-1/4"$  balsa center sheet pieces in half as shown. Custom fit each piece to fit in the four remaining upper and lower forward center sections as shown. Glue these pieces securely in place. On the **Easy Sport 60**, custom fit the remaining four  $10-7/8"$  pieces to fit in the four remaining upper and lower forward center sections as shown. Glue these pieces securely in place.



D 14. With a pencil, draw a line from the joint of the bottom spars to the joint of the bottom TE sheeting. This is the centerline of the wing. Measure back from the aft edge of the bottom spar and make a mark  $3/8"$  and  $2-5/8"$  ( $5/8"$  and  $2-7/8"$  on the Easy Sport 60). Now, make a mark  $7/16"$  on each side of the centerline. This is the basic cutout for the aileron servo tray. Using your servo, adjust the size of the hole appropriately for proper fit and clearance.

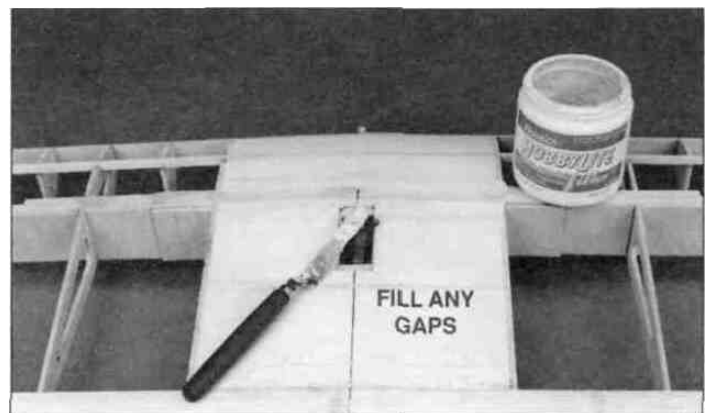

D 16. Using medium (150-grit) sandpaper, sand the top and bottom center sections to smooth out the seams and even up the center sheeting. You may wish to use a lightweight hobby filler such as Hobbico Hobblyte™ to fill in any slight gaps.

## Install the wing tips

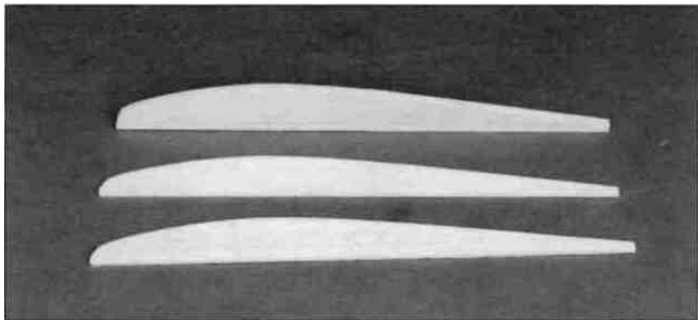

D 1. On the **Easy Sport 40** locate the four die-cut 1/8" balsa **wing tips**. Using medium CA as shown, laminate two of the wing tip pieces together. Perform this step twice. You will end up with two 1/4" thick wing tips. The **Easy Sport 60** uses two die-cut 3/16" balsa wing tips that are not glued together.

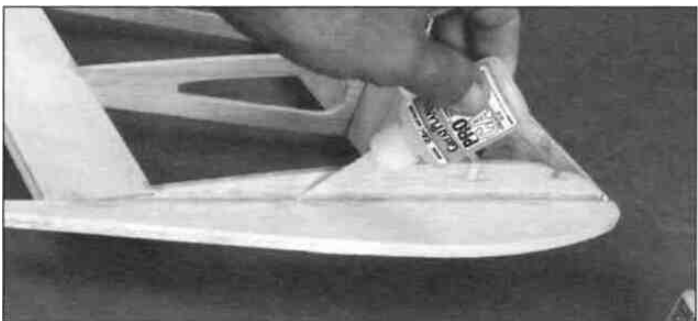

D 2. Sand the TE of the wing so that it is straight and square. Glue the balsa wing tip, perpendicular to and centered on rib #7 (rib #6 on the Easy Sport 60), with medium CA as shown. Repeat for the other wing.

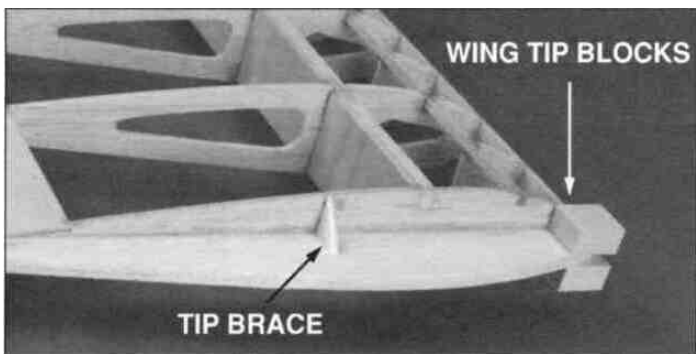

D 3. Locate the die-cut 1/8" (3/16" on the Easy Sport 60) balsa triangle **tip braces** and glue in place as shown on the plan. Also, locate the 1/2" x 7/8" x 4" balsa block from which the **tip blocks** will be cut. Cut the balsa block into four equal lengths. The **Easy Sport 60** comes with pre-cut 3/4" x 1" x 1" **tip blocks**. Glue the tip blocks in place at the front of the wing tips, top and bottom.

D 4. Sand the tip braces, tip blocks and tips to a rounded and pleasing shape (see the **Tip Cross Sections** on the plan). Also sand the front and rear corners of the tips to a radius as shown on the plan.

## Install the ailerons

### EASY-SPORT .40 AILERON

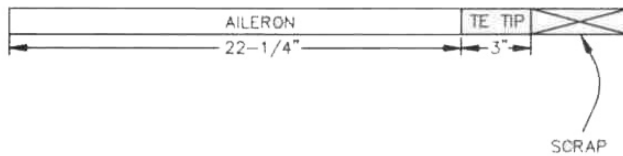

### EASY-SPORT .60 AILERON

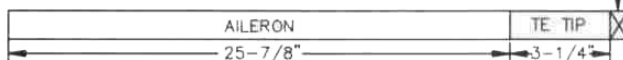

D 1. Locate the two 1/4" x 1-1/4" x 30" (5/16" x 1-3/8" x 30" on the Easy Sport 60) balsa aileron strips. Carefully measure and cut one aileron and TE tip from each of the aileron strips as shown above.

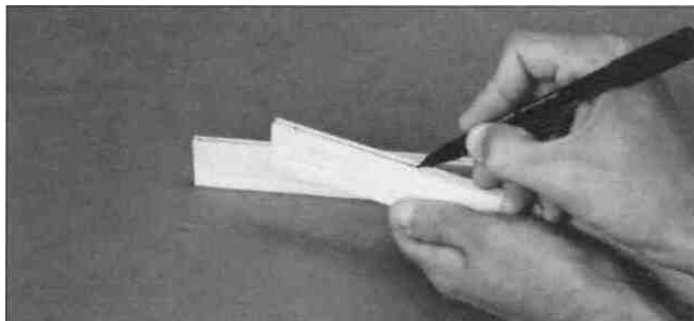

D 2. Carefully mark a centerline on the LE of each aileron.

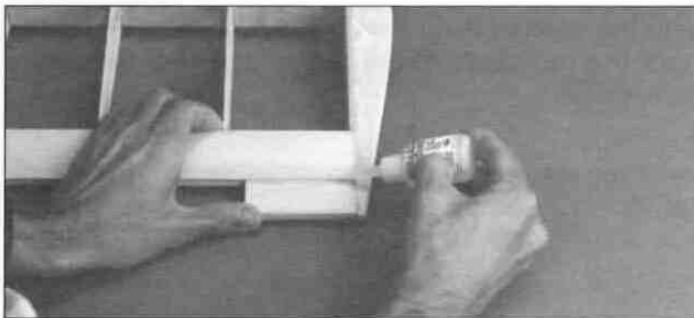

D 3. Center a TE tip on the outboard TE and the protruding portion of the wing tip as shown. Hold in this position and glue in place with thin **CA**. Repeat this **step** for the other wing tip.

D 4. Using the plan as a guide, mark the **hinge locations** on both ailerons and cut the hinge slots.

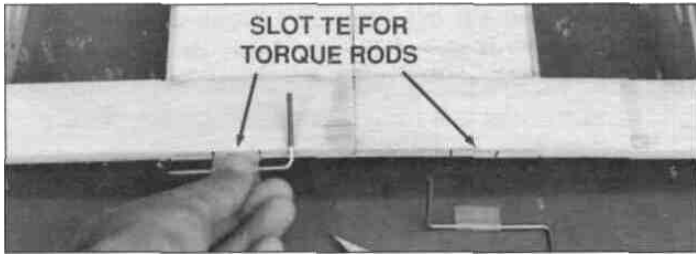

D 5. Align each wing half over its respective view on the plans and mark the locations of the aileron torque rod bearings and hinges. Using the same technique as slotting for hinges, carefully slot the TE to accept the **aileron torque rod** bearing in both wings. It helps to have the torque rod handy for reference.

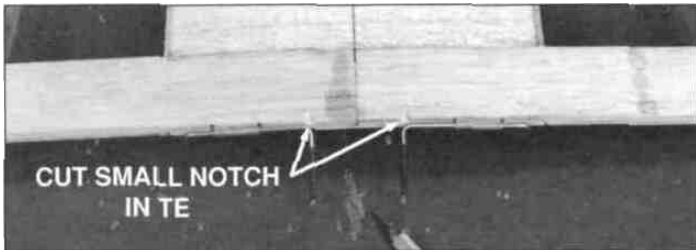

D 6. Cut small notches in the bottom of the TE to allow the torque rod arms to swing forward.

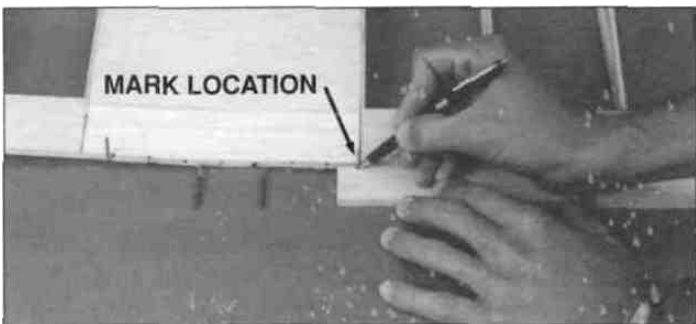

D 7. While holding the ailerons in place against the TE (with the ends of the ailerons lined up with the TE tip), mark the locations where the torque rods will enter the ailerons.

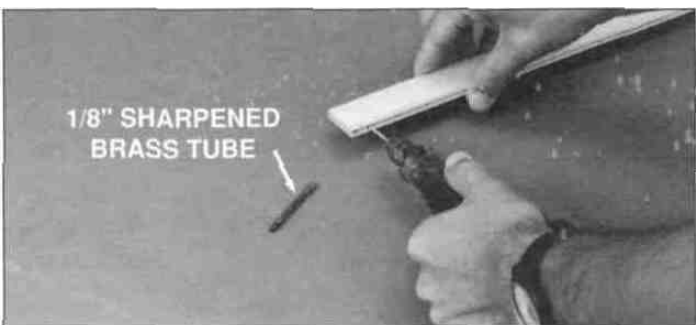

D 8. Drill a  $7/64$ " hole in each aileron to accept the torque rod. Start at the leading edge centerline and drill straight in to the proper depth.

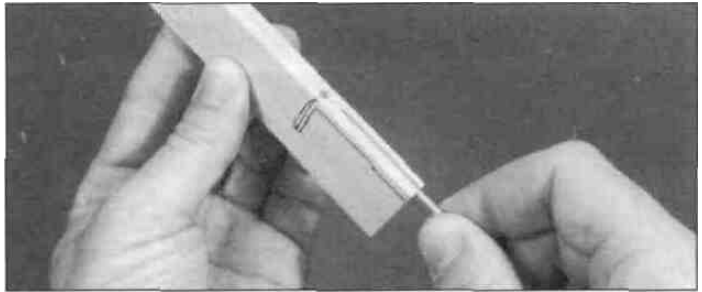

D 9. Use the sharpened  $1/8$ " diameter brass tube to cut a groove in the leading edge of the ailerons to accept the torque rods. Test fit the ailerons onto the torque rods and cut as necessary until they fit.

D 10. Sand the LE of the ailerons to a "V" shape and the TE of the ailerons to a rounded shape, as shown on the plans.

D 11. Test fit the ailerons on the wing. Check for free movement in both directions. There should be no binding. Now is the time to locate any problems and rectify them before the wing is covered and the ailerons are permanently attached. After the ailerons are checked, round the TE tips to match the ailerons.

D 12. Remove the ailerons, hinges and torque rods for now. They'll be reinstalled later.

**Install the wing bolt plate**

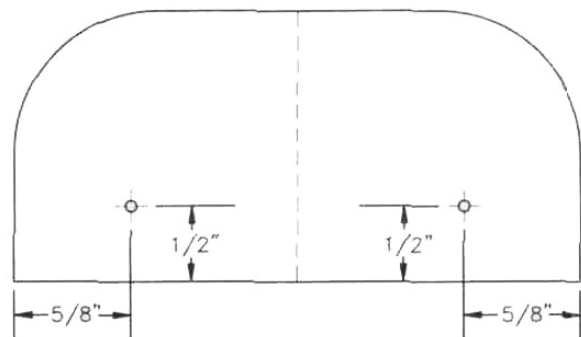

Locate the die-cut  $1/8$ " ply **wing bolt plate (WB)** and, with medium CA, glue it to the top center TE of the wing as shown on the plans. Make sure that (WB) is centered on the TE and securely glued in place. On the **Easy Sport 40**, the punch mark must face up so that you can use it later. On the **Easy Sport 60**, place two marks at the locations shown on the drawing above.

# Fuselage Assembly

## Fuselage sides

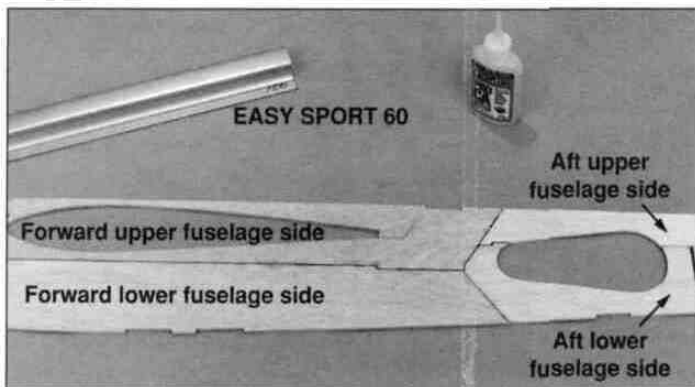
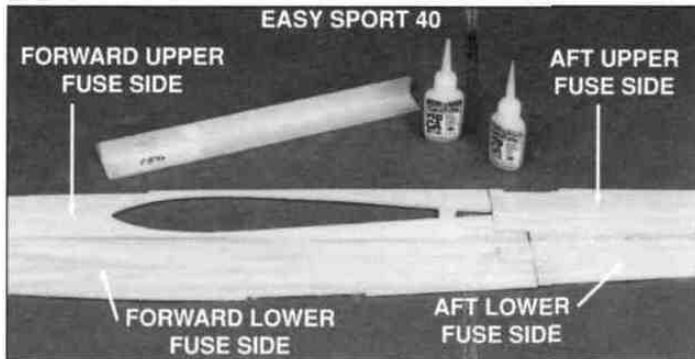

D D 1. Pin or tape the fuse plan to a **flat** surface and cover it with waxed paper. Test fit the die-cut 1/8" balsa **forward upper fuse side, forward lower fuse side, aft upper fuse side** and **aft lower fuse side** together as shown in the photo. Sand them as necessary to achieve a good fit, align them carefully with the plan and glue them together with thin CA.

**NOTE:** On the Easy Sport 40, you can also check the alignment of these parts using a straightedge along the centerline of the assembly.

D D 2. Remove the fuse side from the plans and inspect the glue joints for gaps, adding thick CA glue if necessary. Sand the glue joints smooth on both sides using a T-bar and medium (150-grit) sandpaper. Then repeat the above steps to make the other fuse side.

D D 3. Pin the two assembled fuse sides together. Sand the edges as necessary to make the two sides **identical**.

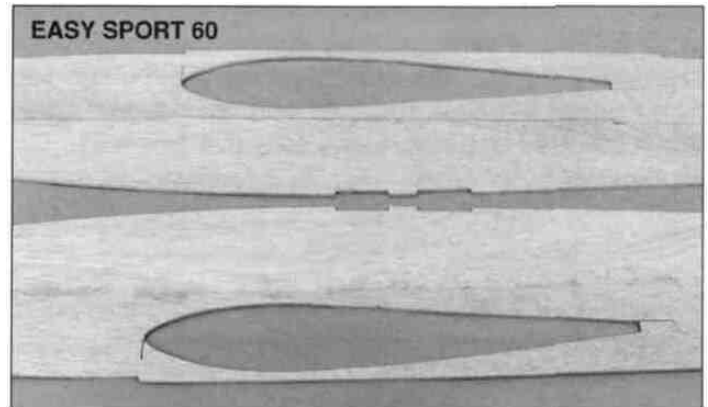
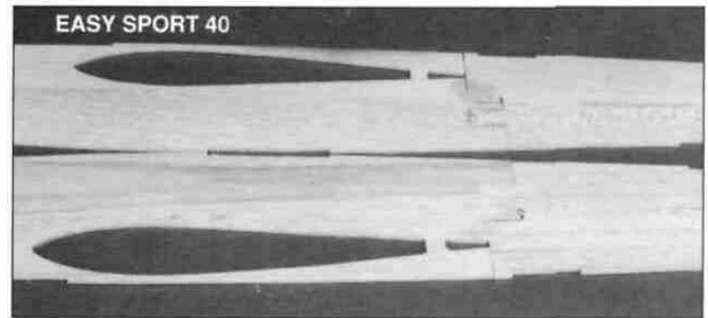

D D 4. Position the two fuse sides as shown and mark one with the words "Right inside" and the other "Left inside." Doing so will assist you in building and identifying the fuse sides.

**DO NOT MAKE TWO RIGHT SIDES!**

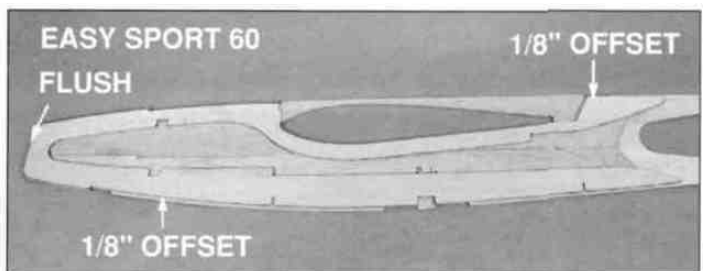
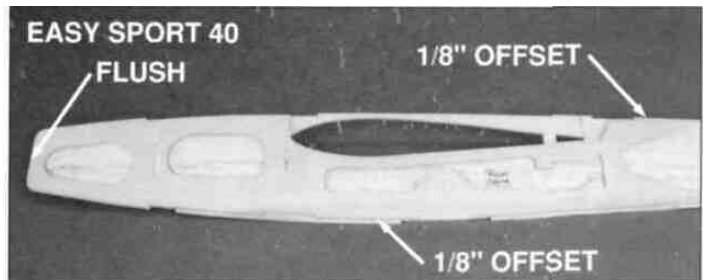

D D 5. Glue the die-cut 1/8" ply **fuse doublers** to the inside of the fuse sides, making a **RIGHT** and a **LEFT** side. The front and the wing saddle of the doublers should be flush with the front and wing saddle of the fuse sides. The bottom of the doubler will be offset 1/8" from the bottom of the fuse side.

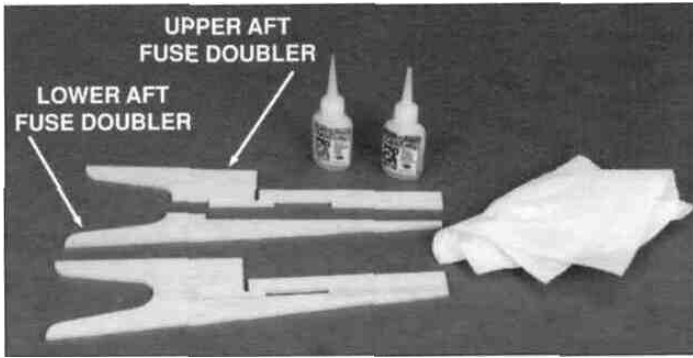

D D 6. In the same manner that you assembled the fuse sides, locate and glue together the die-cut 1/8" balsa **upper aft fuse doubler** and die-cut 1/8" balsa **lower aft fuse doubler**. Make sure that you make two **aft doubler** assemblies.

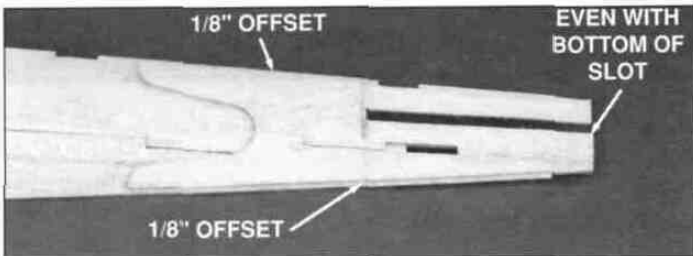

D D 7. Glue the balsa **aft doublers** in place. The doubler should line up with the lower edge of the stab slot and be **offset 1/8" from the top and bottom of the fuse side**.

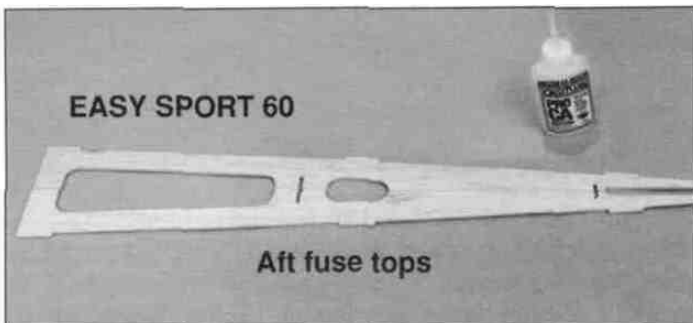

D 8. Test fit and glue the two die-cut 1/8" balsa **aft fuse tops** together as shown in the photo. Sand smooth.

**THIS STEP FOR EASY SPORT 40 ONLY**

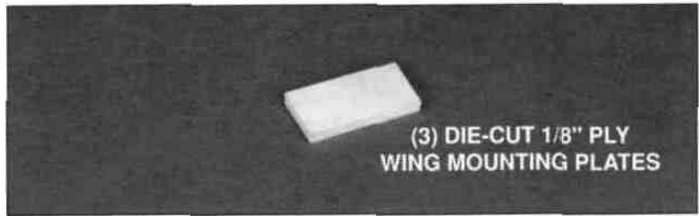

D 9. Using medium CA, glue the three die-cut 1/8" ply wing bolt plates (BP) together, aligning the edges carefully. After the glue hardens, sand the edges to make them uniform.

**THIS STEP FOR EASY SPORT 60 ONLY**

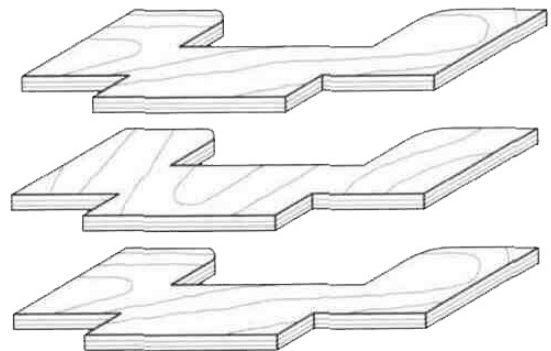

D 9. Notice that two pieces of the wing bolt plate assembly have grain running in one direction while the third piece has the grain running opposite to the first two. The odd one is "sandwiched" between the other two. Use 30-minute epoxy to glue the three wing bolt plates together. Clamp the assembly together while the epoxy cures. After the epoxy cures, sand the edges to make them uniform.

**STEPS 1-5 FOR EASY SPORT 40 ONLY**

**Firewall assembly**



D 1. Locate the die-cut 1/8" ply **Former F1A** and the die-cut 1/8" ply **Former F1B**. Using 6-minute epoxy, securely glue F1B to F1A so they are aligned with each other and the punch marks on F1A are visible.



Q 2. If you are going to use the engine mount supplied with the kit, drill a 5/32" hole through the firewall at each of the four punch marks. If you are going to use a different mount, center it on the embossed lines and mark and drill the mounting holes.

Q 3. Locate the die-cut firewall tripler **F1 C** and drill a 5/32" hole through the tripler at each of the four engine mount punch marks.

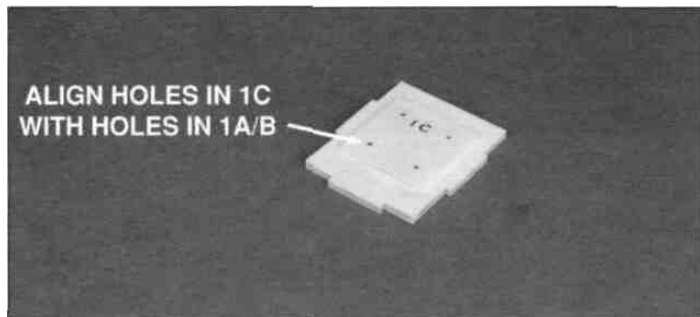

D 4. Using medium CA, securely glue F1 C to the **back** of the previously laminated F1A and F1B. Align F1 C by lining up the holes in the formers. Once attached, redrill the holes to clean out any hardened CA.

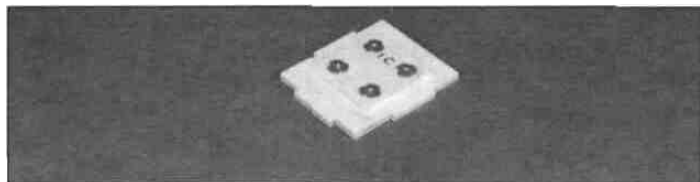

D 5. Insert the #6-32 **Blind Nuts** into the engine mounting holes in F1 C. Tap the blind nuts in place with a hammer. Apply epoxy or thick CA to the blind nut flanges and F1 C to hold them in place.

**NOTE:** Do not allow the glue to enter the threaded portion of the blind nuts.

Clamping the assembly to a table or flat board will eliminate any warp in the formers. **Caution:** Check that the formers do not move out of alignment when they are clamped to the table. After the epoxy cures, sand the edges to make them uniform.

D 2. If you are going to use the engine mount supplied with the kit, drill a 7/32" hole through the firewall at each of the four punch marks. If you are going to use a different mount, center it on the embossed lines, mark and drill the mounting holes.

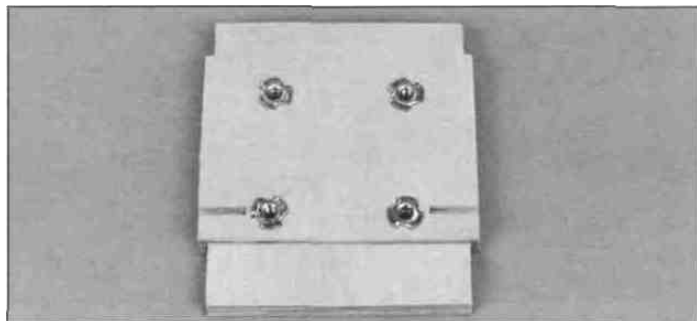

D 3. Insert the **#8-32 Blind Nuts** into the engine mounting holes in F1 D. Tap the blind nuts in place with a hammer. Apply epoxy or thick CA to the blind nut flanges and F1 D to hold them in place.

**Note:** Do not allow the glue to enter the threaded portion of the blind nuts.

#### FIREWALL OPTIONS

Use This Diagram To Drill The Firewall Holes

2-Stroke  
Tricycle

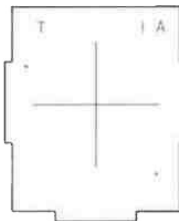

2-stroke  
Taildragger

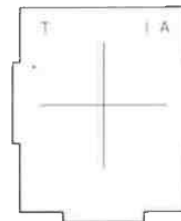

4-Stroke  
Tricycle

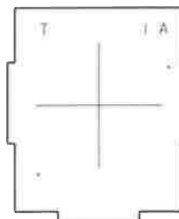

4-stroke  
Taildragger

#### STEPS 1-3 FOR EASY SPORT 60 ONLY

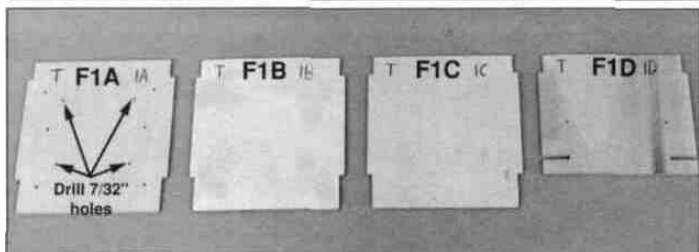

D 1. Locate the die-cut 1/8" ply Formers **F1A**, **F1B**, **F1C** and **F1D**. Using 6-minute epoxy, securely glue F1A, F1B, F1C and F1D together. Make sure that F1A is on top of the stack with the punch marks facing outward and that F1D is on the bottom of the stack. Check that the locking tabs are aligned and the top of the formers are flush. Weight or clamp the assembly over waxed paper to a flat table or board while the epoxy cures.

Carefully study the "Firewall Options" sketch, and, depending on which version of the Easy Sport you are building, drill at the appropriate punch marks with a 3/16" drill.

## Former preparation

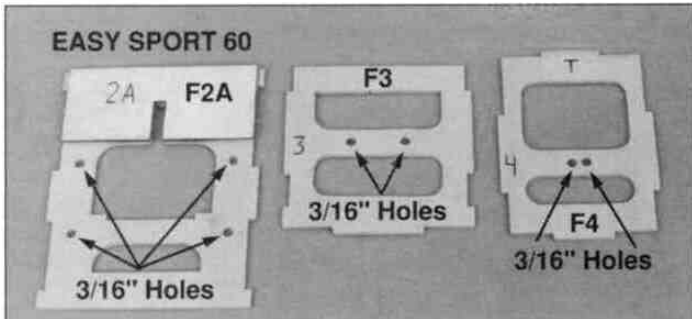
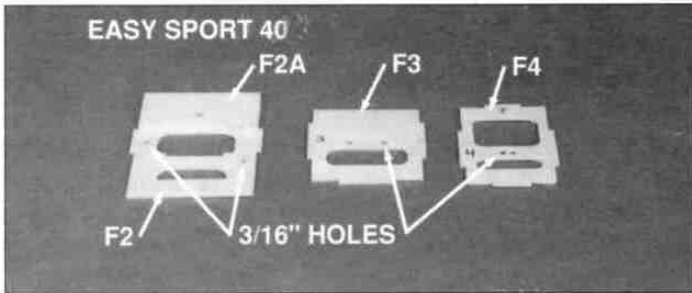

D 1. Glue the die cut 1/8" ply **F2A** to the die-cut 1/8" ply **F2** as shown. To insure proper pushrod routing later, **F2A** must be glued to the side of **F2** that has the embossed "2". Drill a **3/16"** hole at each of the four punch marks on **F2**, **F3** and **F4**.

Drill a **1/4"** hole at the punch mark on **F2A** (drill all the way through **F2**)

➔ Perform step #2 only for the Easy Sport 40 taildragger version

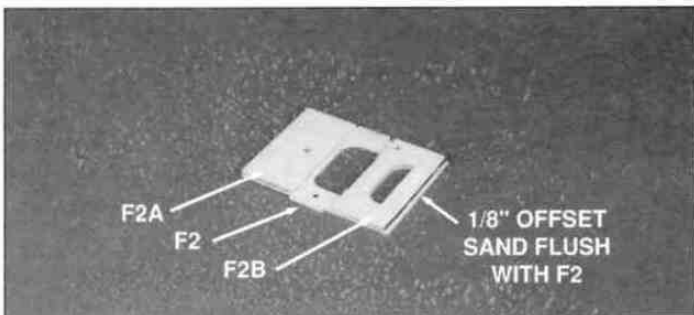

D 2. For a taildragger version, glue **F2B** to the front of **F2**. Line up the large hole in each as shown. There will be a 1/8" offset between the bottoms of **F2** and **F2B** when properly aligned. Using coarse (80-grit) sandpaper, sand **F2** flush with the bottom of **F2A**. Drill a **3/16"** hole at each of the two punch marks on **F2B** (drill all the way through **F2**).

## Assemble the fuselage

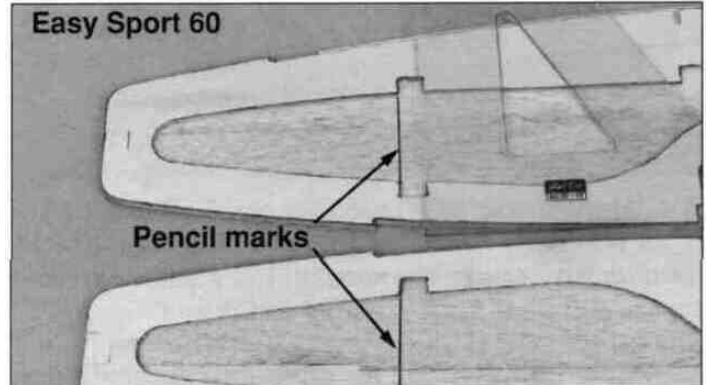
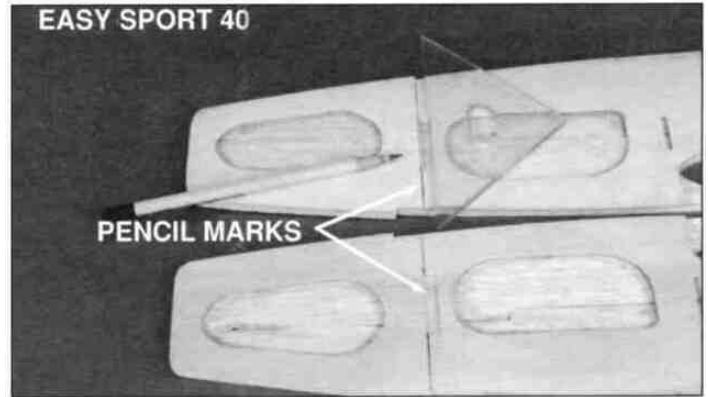

D 1. With a pencil and a straightedge, draw a line from top to bottom of each fuse doubler at the forward edge of the slot for **F1** as shown.

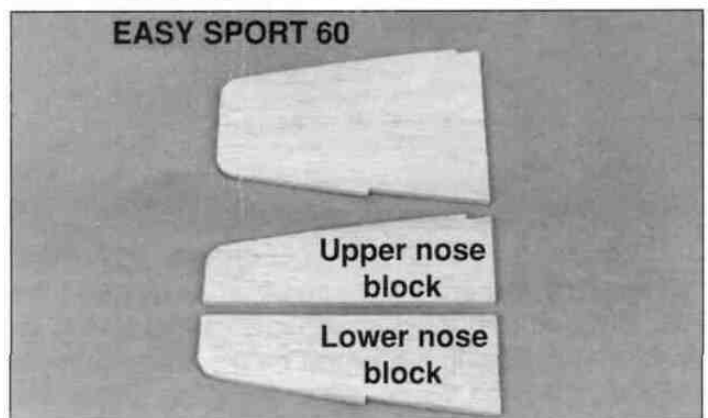
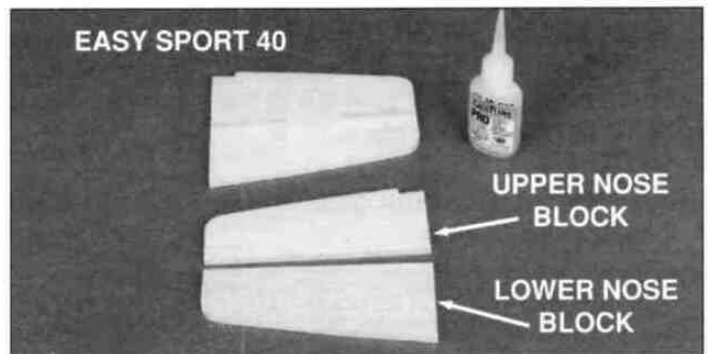

D 2. Locate a die-cut 3/16" balsa **upper nose block** and a die-cut 3/16" balsa **lower nose block**. True-up the

edges with a sanding block and glue them together as shown using medium CA. Sand the glue joints smooth. Make two assemblies.

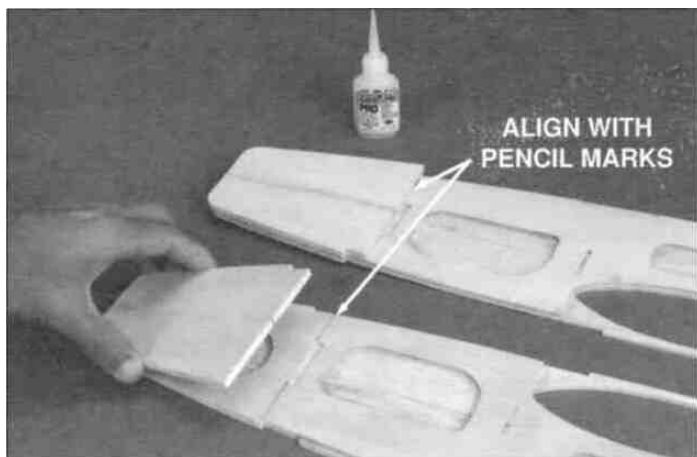

D 3. Align the aft edge of the nose blocks with the line drawn on each fuse doubler. The notch in the nose blocks will align with the notch in the doubler. The nose blocks are approximately 3/16" oversized around their perimeter. This is to allow extra for alignment. The nose blocks will be sanded to final shape later. Glue the nose blocks in place with medium CA.

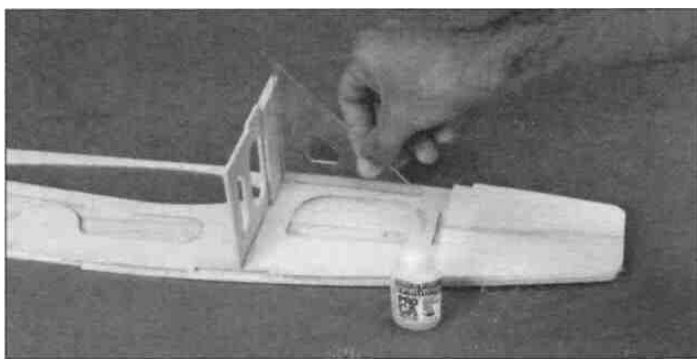

D 4. Test fit **Former F2** in place on the **left** fuse side so that F2A is in **front** of F2. Press it down into its slot and use a 90 degree triangle to keep it perpendicular to the fuse side. Make sure that F2 is flush with the front of the wing saddle. Glue it in place with thin CA.

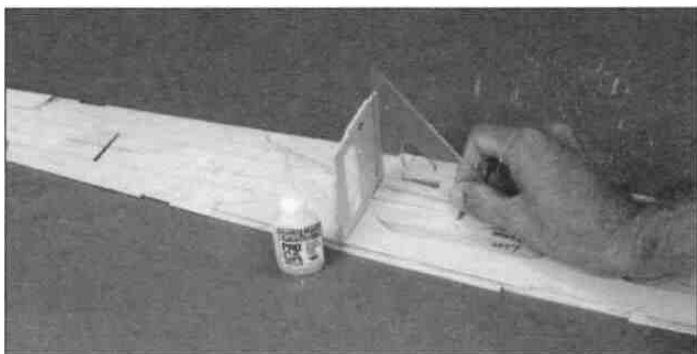

D 5. Test fit the die-cut 1/8" ply **former F3** in place on the left fuse side. Press it down into its slot and use a 90

degree triangle to keep it perpendicular to the fuse side. Glue it in place with thin CA .

D 6. Position the die-cut 1/8" ply **formers F4** and F5 in their respective slots on the left fuse side. Press them down into their slots and **just tack-glue** in place with a drop of thin CA .

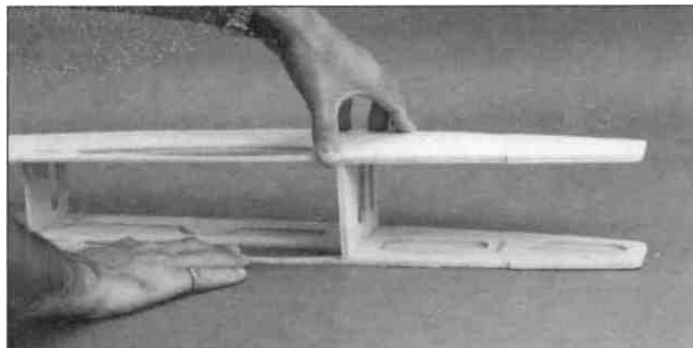

D 7. Position the **right** fuse side in place so that the F2 and F3 formers key into their slots. Glue the fuselage side to the F2 and F3 only.



D 8. Working directly over the plan, position the 1/8" balsa **aft fuse top** (that you assembled earlier) into place and position the formers to key into their notches. Pull the aft end of the fuselage together, making sure the fuselage is symmetrically lined up with the top, and glue the top to the fuse sides and the formers.

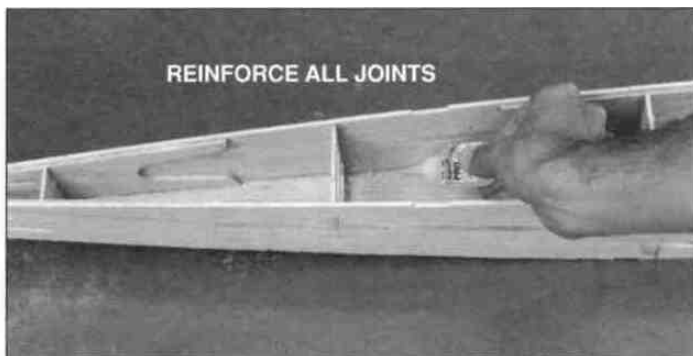

D 9. Examine all of the internal seams and joints from former F3 **aft**. Use medium or thick CA to reinforce all glue joints.

If you are building the **Easy Sport 60**, skip to page 29 and continue the building process at **Install the Firewall**.

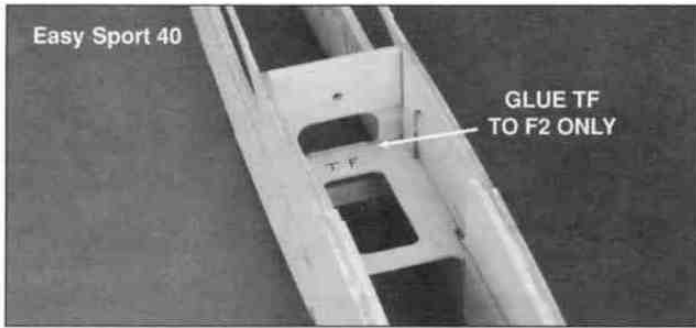

D 10 Place the die-cut 1/8" ply **tank floor** into the notch in former F2. The tabs on the side of the tank floor will rest in the cut-outs in the fuse doublers as shown. Glue the tank floor where it meets F2 only.

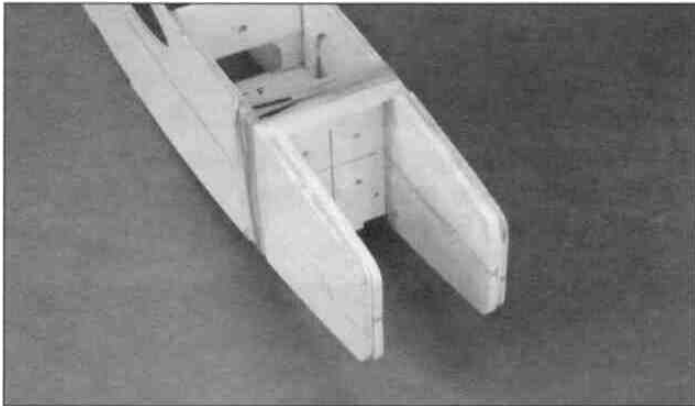

D 11. Test fit the firewall in place between the fuse sides. You may need to sand the edges so that the firewall properly keys into its notches and fits snugly behind the nose blocks. When satisfied with the fit, remove the firewall. Then use 30-minute epoxy to glue it to the edges of the firewall and the three unglued edges of the tank floor. Put the firewall in place and use rubber bands and/or masking tape to pull the two fuse sides in tight against the firewall and tank floor. Wipe off any excess epoxy with a paper towel dampened with alcohol before it cures.

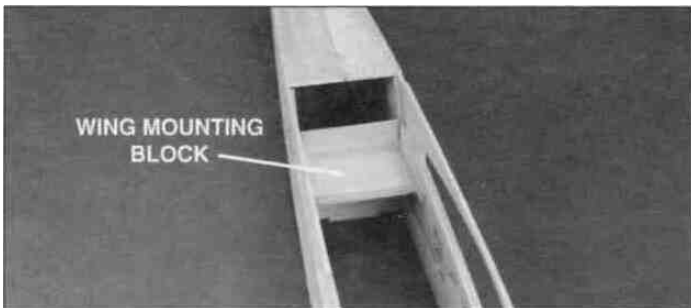

D 12 Test fit the laminated **wing mounting block** into the notches in the fuselage doublers. Sand if necessary to achieve a good fit. Mix up some 30-minute epoxy and apply it to the sides and aft edge. Slide the wing mounting block into the notches in the fuselage doublers and position securely against the front of former F3.

## Install landing gear mounts

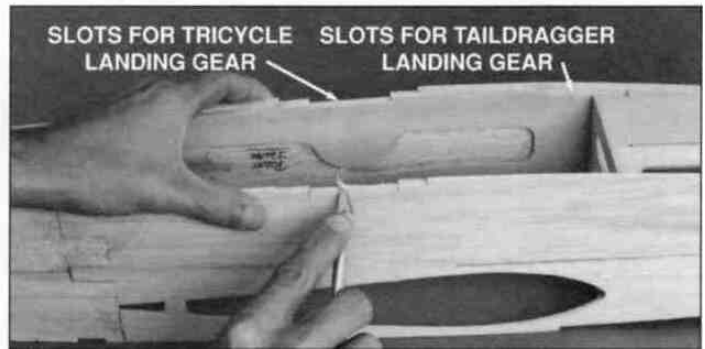

D 1 Depending on the landing gear configuration, trim out the appropriate slots in the balsa fuselage sides for the landing gear plate using a hobby knife. The aft slot is for a tricycle landing gear. The forward slot is for a taildragger.

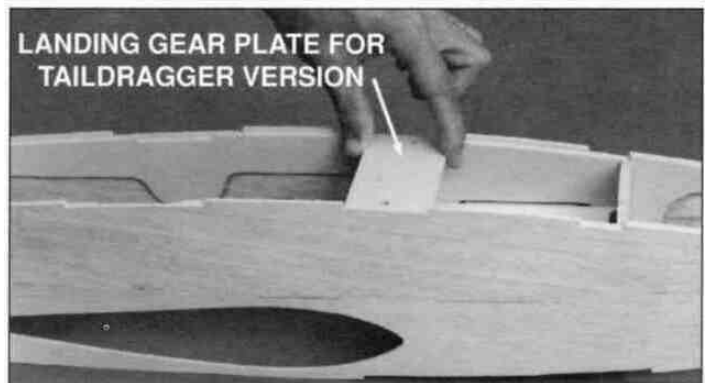
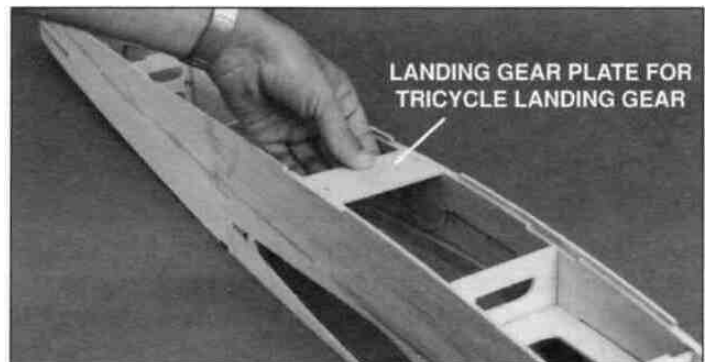

D 2 Drill a **3/16"** hole at each of the punch marks on the **landing gear plate**. Glue the landing gear plate to both fuselage sides, in the proper slot, using medium CA.



D 3. Locate the four **landing gear doublers (GD)** and glue together in pairs using medium CA as shown. Make sure that the slots in the landing gear doublers align.

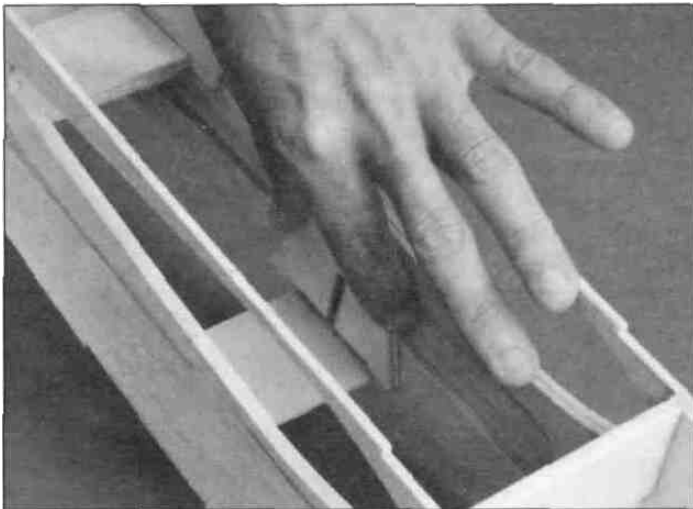

D 4. Test fit the landing gear doublers over the landing gear plate, aligning the slots in the landing gear doublers with the holes in the landing gear plate. Glue the landing gear doublers to the landing gear plate and fuse doubler with 6-minute epoxy. Make sure no glue obstructs the holes in the landing gear plate or the slots in the landing gear doublers.

➡ Perform steps #5, 6 and 7 only for the taildragger version

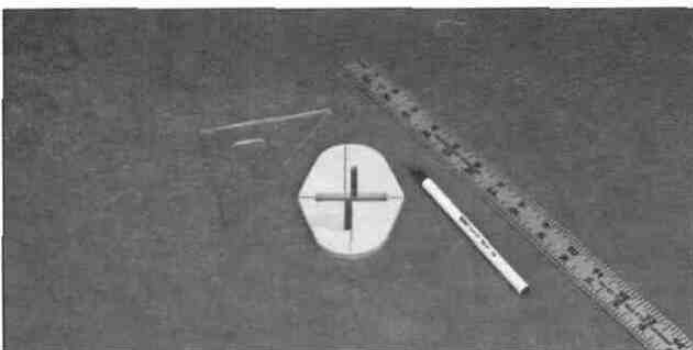

D 5. Arrange the laminated landing gear doublers as shown and draw extended lines from one to the other.

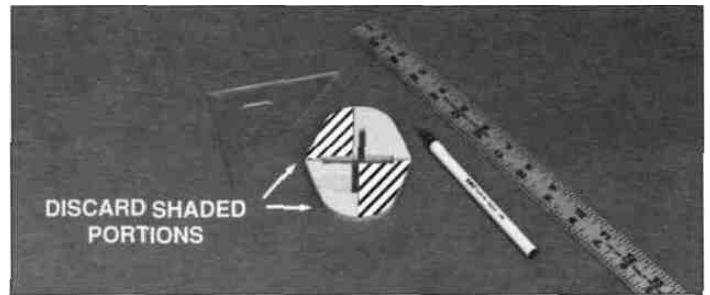

D 6. Carefully cut the landing gear doublers on the lines and discard the shaded portions as shown.

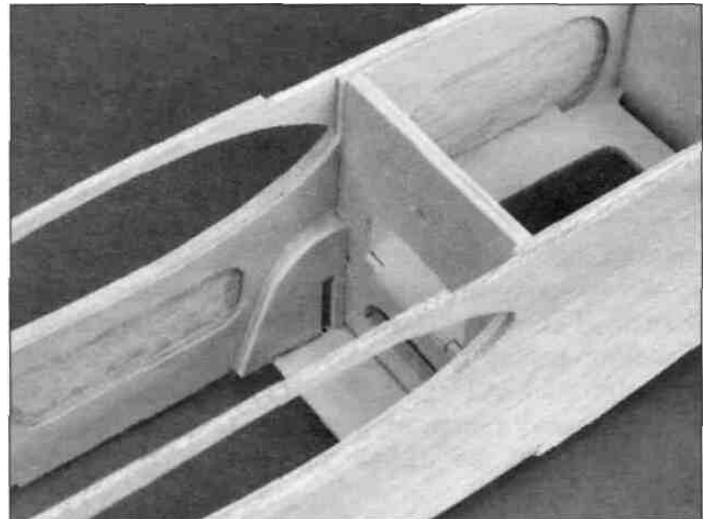

D 7. Test fit the landing gear doublers over the landing gear plate, aligning the slots in the landing gear doublers with the holes in the landing gear plate. Glue the landing gear doublers to the landing gear plate, fuse doubler and F2 with 6-minute epoxy. Make sure no glue obstructs the holes in the landing gear plate or the slots in the landing gear doublers.

### Install the firewall

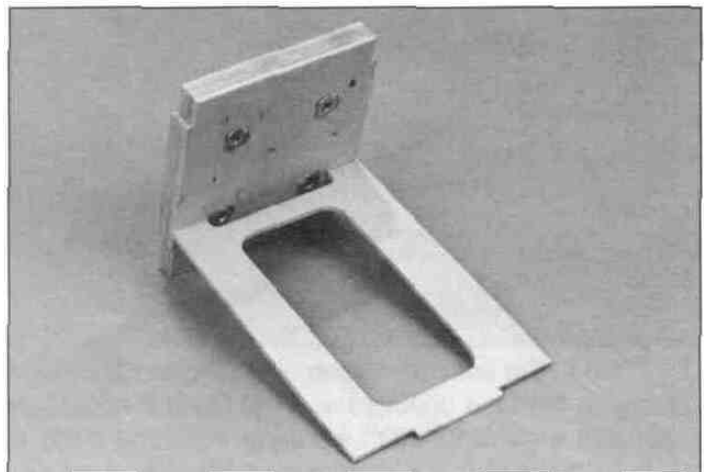

D 1. Trial fit the die-cut 1/8" ply **tank floor** into the slots in former **F1 D**. Do not glue.

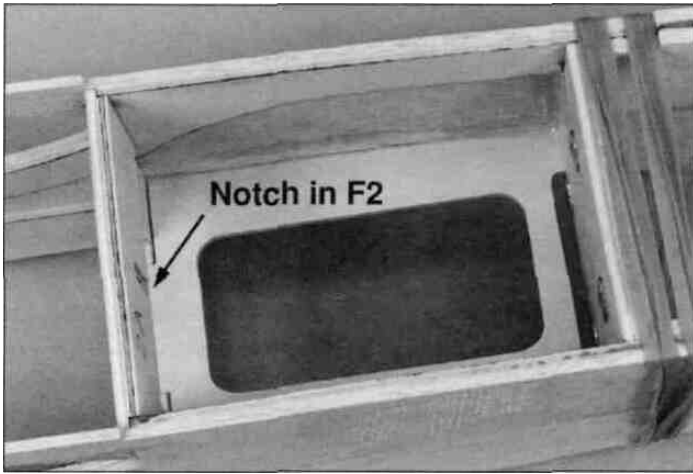

D 2 Test fit, but do not glue, the firewall/tank floor assembly between the fuse sides. The rear tab of the tank floor should fit into the notch in F2 and set on the ledge created by the fuse doublers. The firewall should fit in the notches in the fuse doublers. After you have checked the fit, glue the firewall to the fuse sides with 30-minute epoxy. **Important:** Make sure the tank floor is positioned correctly. Once the firewall is glued in, the tank floor cannot be removed. Clamp the fuse sides against the firewall with rubber bands or masking tape until the epoxy cures. After the epoxy cures, glue the tank floor to F2, the firewall and the fuse doublers with medium **CA**.

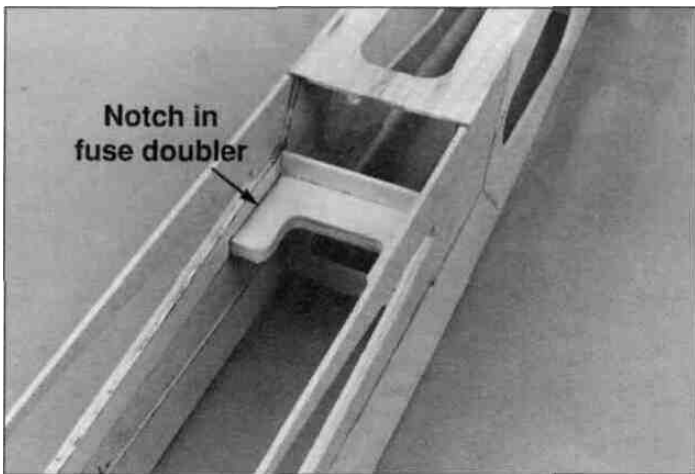

D 3 Trial fit the laminated wing mounting block into the notches in the fuse doublers and F3. Sand if necessary to achieve a good fit. Glue the wing mounting block to the fuse sides, fuse doublers and F3 with 6-minute epoxy. Make sure the wing mounting block is tight against the fuse doublers and F3.

## Install landing gear blocks

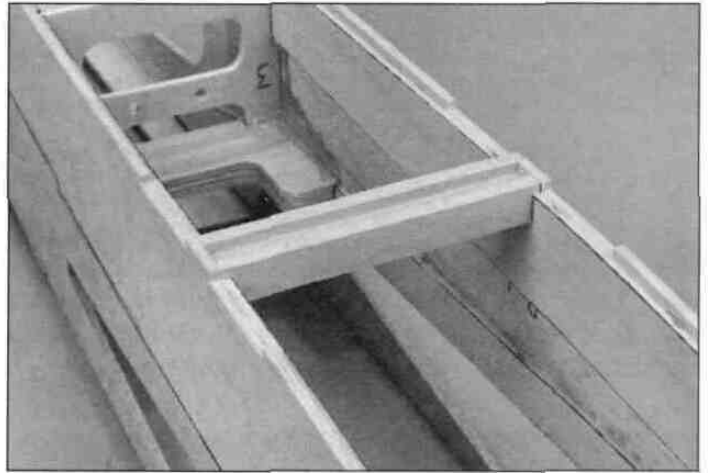

D 1. Depending on the landing gear configuration, test fit, but **do not glue**, the grooved hardwood **landing gear (LG) rail** in the notches in the bottom fuse doubler. The aft notches are for the tricycle landing gear. The forward notches are for a taildragger. The landing gear rail should fit snugly in the notches and between the fuse sides.

Perform steps #2,3 and 4 for the **taildragger version**.

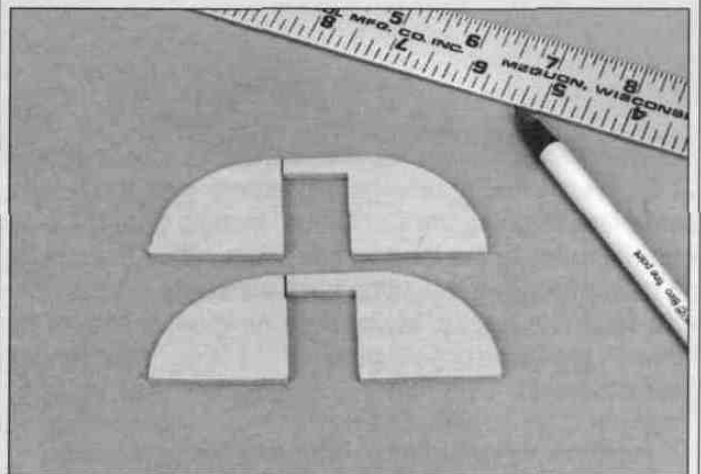

□ 2. Draw an extended line as shown on both **landing gear doublers (LGD)**.

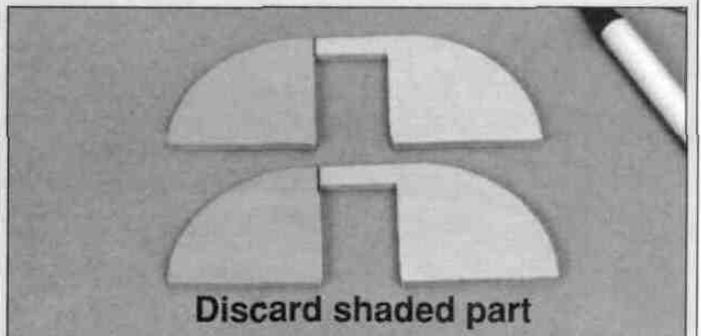

**Discard shaded part**

□ 3. Carefully cut the landing gear doublers on the lines and discard the shaded portions as shown.

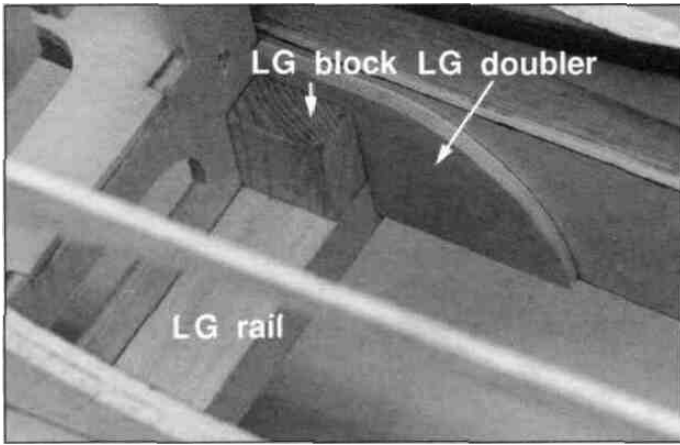

D 4. Glue the LG rail and LG blocks to the fuse sides and fuse doubler with 30-minute epoxy. Then immediately glue the LG doublers in position with medium CA. To hold the LG blocks in position while the epoxy cures, wedge a leftover balsa stick between the blocks. Turn the fuse over and place weight on the LG rail to hold it down.

**Continue with assembly at step #7.**

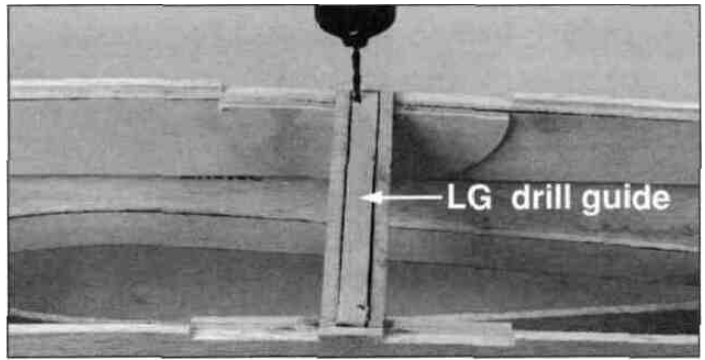

D 7. After the epoxy has fully cured, fit the die-cut 1/8" ply **landing gear drill guide** into the groove in the landing gear rail (it does not matter which way it goes in). Drill a **3/32"** pilot hole through the rail and landing gear blocks at each punch mark on the guide. Use care to drill the holes perpendicular to the rail. Look inside the fuse to make sure you drilled the holes straight into the landing gear blocks.

D 8. Remove the drill guide, then redrill the holes with a **3/16"** bit. **Hint:** If you have a numbered drill set, you may drill the holes with a #12 drill bit for easier installation of the landing gear.

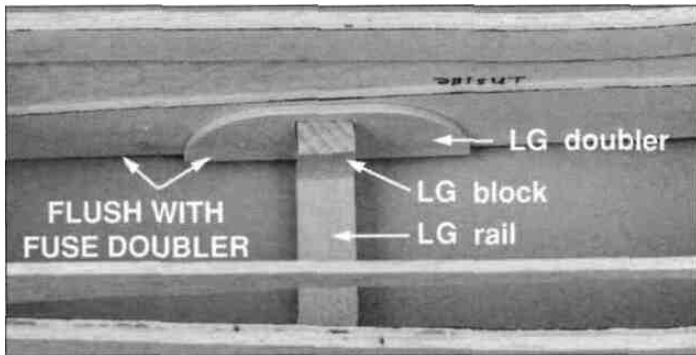

D 5. While the landing gear rail is in position, test fit the hardwood **landing gear blocks** and the two die-cut 1/8" ply **landing gear doublers (LGD)** on top of the rail. **Note:** The grain direction of the LG blocks is vertical (as shown on the plans). Check that the LGD is flush with the edge of the fuse doubler.

D 6. Glue the LG rail and LG blocks to the fuse sides and fuse doubler with 30-minute epoxy. Then immediately glue the LG doublers in position with medium CA. To hold the LG blocks in position while the epoxy cures, wedge a leftover balsa stick between the blocks. Turn the fuse over and place weight on the LG rail to hold it down.

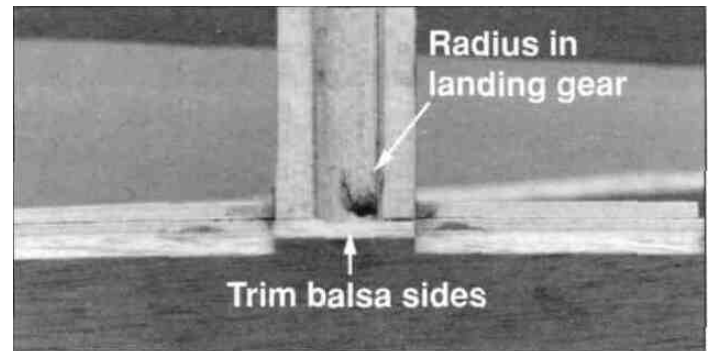

D 9. Carve a **radius** in each LG rail hole toward the center of the fuse to allow the **main landing gear** to fully seat in the holes. Also trim the balsa fuse sides at the end of the groove in the landing gear rail. Test fit the main landing gear in the LG rail. A file can be used to remove any burrs or sharp edges from the ends of the main landing gear. Remove the main landing gear and set it aside until final assembly.

## Install the pushrod guide tubes

PUSHROD LAYOUT  
As Viewed From The Top

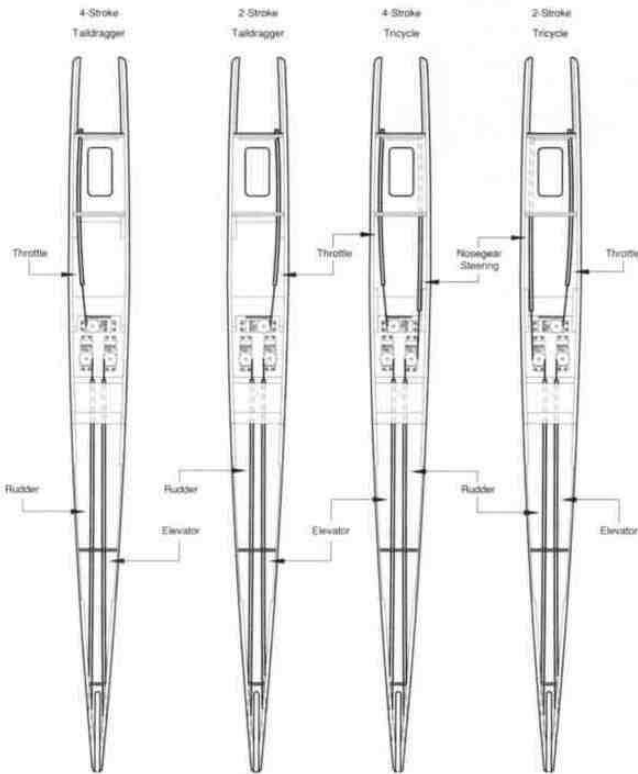

**NOTE:** You must refer to the proper version in these sketches as you install the pushrod tubes.

The following instruction photos apply to the installation of a 2-stroke engine with a tricycle landing gear.

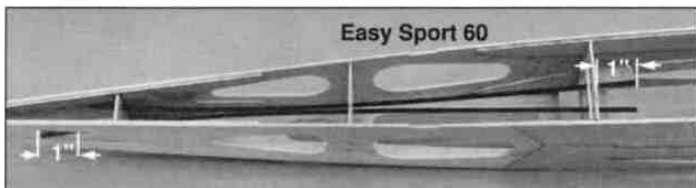
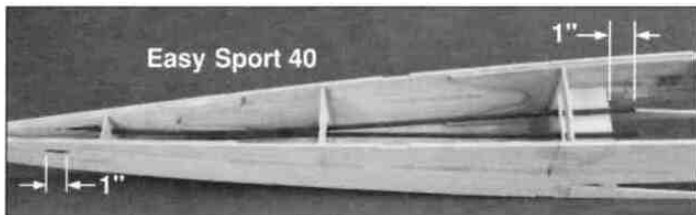

D 1. Locate the two 36" **outer pushrod guide tubes** and scuff the outsides with fine (220 grit) sandpaper. Working from the open fuse bottom, route the tubes through the F5, F4 and F3 formers as shown. Make sure that both pushrod guides extend 1" as shown. The tubes must also protrude at least 1" from the fuse side exits. Securely glue both pushrod guides to each former and fuse side with medium CA. Finish the tubes at the fuse side exits (procedure described below). Save the excess lengths of outer tube.

**EXPERT TIP**

A clean and well executed pushrod exit is surprisingly easy to do and for those who notice, the sign of a true craftsman. In two simple steps, you can be rewarded with simple, durable and aerodynamically clean pushrod exits.

A. Fill any gaps around the outer pushrod guide tubes with a lightweight hobby filler such as Hobbico Hobblyte. Make sure that the filler material completely fills any and all voids at the pushrod exit. Allow the filler material to fully harden.

B. Trim the protruding pushrod guide tube to within 1/8" from the fuse side. Then, with a sanding block and 150-grit sandpaper, sand the pushrod guide tube and filler material flush with the fuse side.

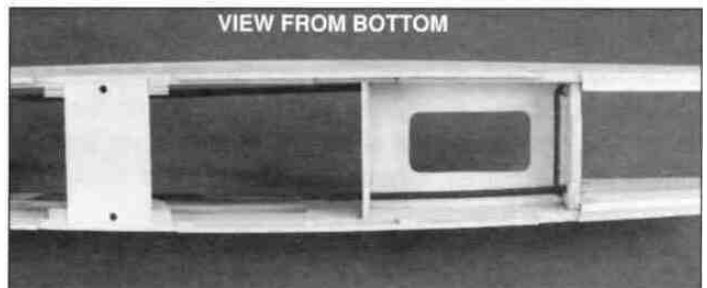
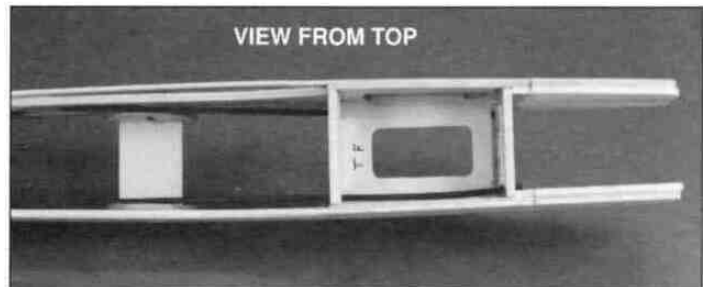

D 2. Using the excess outer pushrod guide tube material from the previous step, install the throttle and nosewheel steering guide tubes as shown. The nosewheel guide should be **flush** with the firewall and the throttle guide should protrude **1/8"** to **1/4"** from the firewall. Refer to the pushrod layout diagram for the version you are building.





Bevel top and bottom of F3A as shown. Not shown to scale.

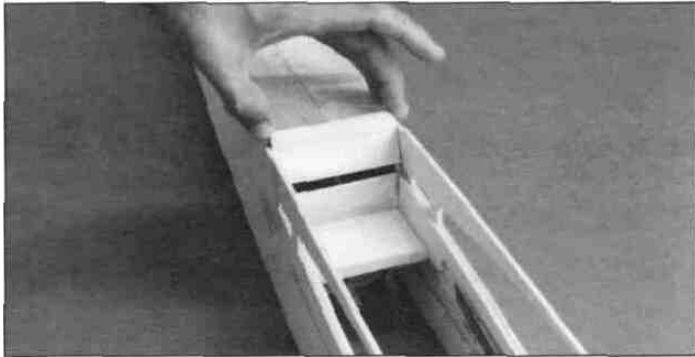

D 3. Locate former **F3A** and bevel the top and bottom to the profile shown in the sketch. Then, glue in place with medium CA as shown.

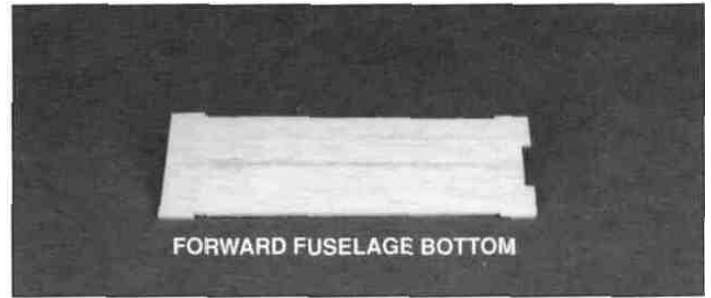

D 2. Locate the two die-cut 1/8" balsa **forward fuse bottom** halves and glue together in the same manner as step #1.

D 3. Locate the two die-cut 1/8" balsa **middle fuse top** halves and glue together in the same manner as step #1.

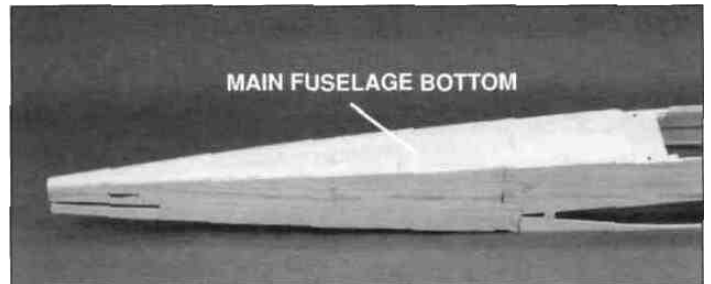

D 4. Test-fit the **main fuse bottom** into place between the fuse sides. Sand the edges, if necessary, for a good fit. Apply thick CA to the edges of the main fuse bottom and the bottom of formers F3 and F4. Press the main fuse bottom in place, making sure that F3 and F4 key into their slots.

### Finish the fuselage

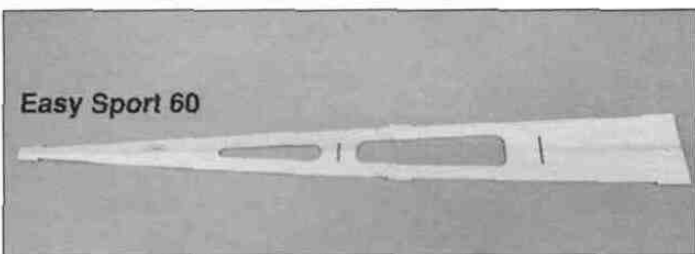
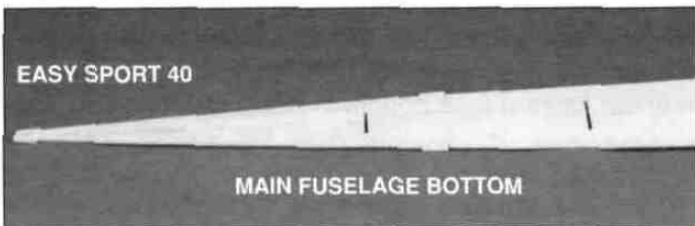

D 1. Locate the two die-cut 1/8" balsa **aft fuse bottom** halves and the two die-cut 1/8" balsa **middle fuse bottom** halves. Sand the edges slightly until they fit together properly. Working directly over the plan top view (covered with waxed paper), glue the four parts together with thin CA to form the **main fuse bottom**. Remove the main fuse bottom from the plans and inspect the glue joints for gaps, adding thick CA glue if necessary. Sand the glue joints smooth on both sides with an Easy-Touch bar sander and 150-grit sandpaper.

Skip steps 5-11 if you are building a tricycle gear.

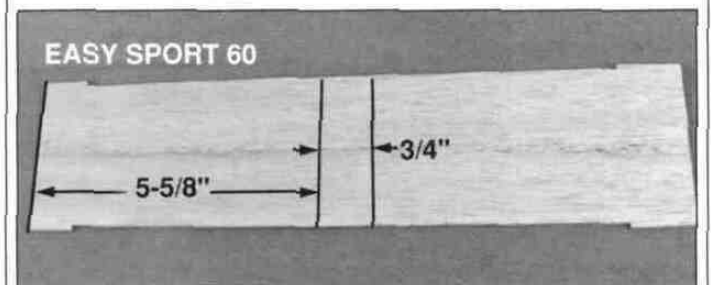
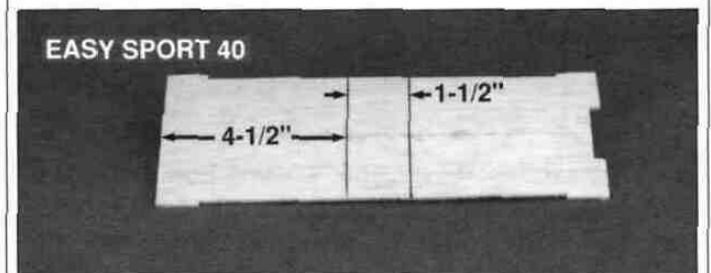

D 5. Carefully measure and cut the forward fuse bottom as shown. **Keep** the small center portion from the Easy Sport 60 forward fuse bottom to use as filler in step 10.

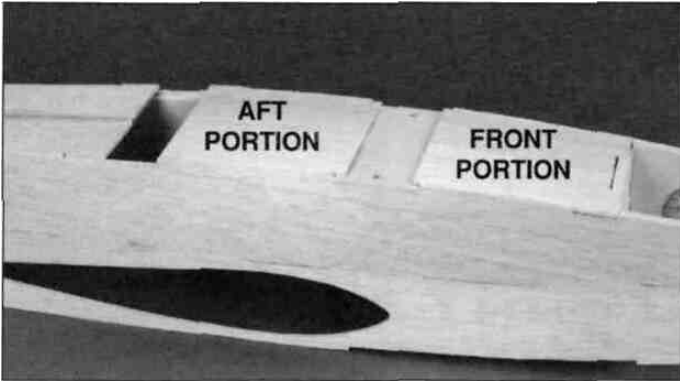

D 6. Test fit the front portion of the forward fuse bottom between the fuse sides. Sand the edges of the front forward fuse bottom if necessary for a good fit. Apply thick CA to the edges and press into place. On the **Easy Sport 40 only**, make sure that the tab on the bottom of the firewall fully engages the slot. On the Easy Sport 60, the tabs on the forward fuse bottom will lock into the fuse sides when in position.

D 7. Test fit the aft portion of the forward fuse bottom between the fuse sides. The tabs on the aft fuse bottom will lock into the fuse sides when in position. Sand the edges of the aft forward fuse bottom if necessary for a good fit. Apply thick CA to the edges and press into place.

### STEPS 8 & 9 FOR EASY SPORT 40 ONLY

D 8. Turn the fuse over and, working from the inside, press the front forward fuse bottom and aft forward fuse bottom so that they contact the ply landing gear plate. Glue the front forward fuse bottom and aft forward fuse bottom to the landing gear plate with medium **CA**.

D 9. From the inside, test fit and center the die-cut 1/8" ply filler plate over the gap between the main fuse bottom and the aft forward fuse bottom. Sand, if necessary, so it will fit between the fuse doublers. Glue the filler plate to the fuse doublers, main fuse bottom and aft fuse bottom with medium CA.

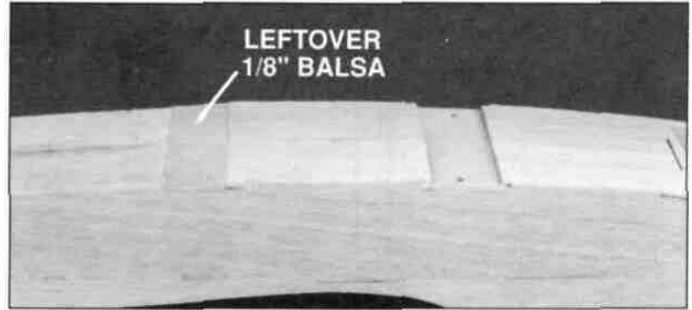

D 10. From the bottom of the fuse, fill the area above the filler plate on the **Easy Sport 40** with a piece of leftover 1/8" balsa. On the **Easy Sport 60**, use the center portion cut in step 5 to fill the gap between the forward fuse bottom and the main fuse bottom. Glue in place with medium CA and sand smooth with medium (150-grit) sandpaper.

D 11. **Skip step #12 if you are building a taildragger.**

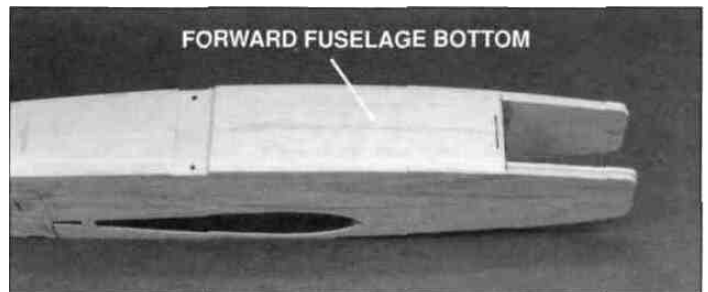

D 12. Press the forward fuse bottom into place between the fuse sides. On the **Easy Sport 40**, make sure that the tab on the bottom of the firewall fully engages the forward fuse bottom. On the **Easy Sport 60** the tabs lock into the notches in the fuse sides when in position. Glue the forward fuse bottom in place with thin CA. Turn the fuse over and, working from the inside, press the forward fuse bottom and main fuse bottom so that they contact the landing gear plate (rail) and glue with medium **CA**.

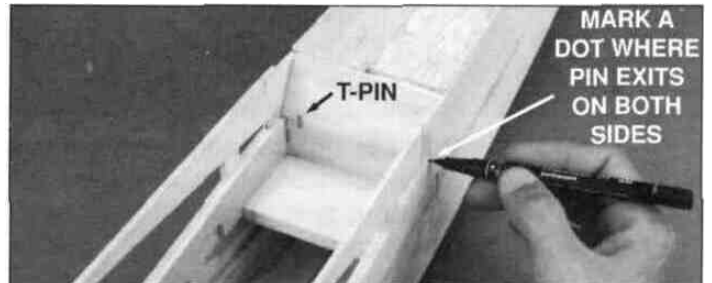

D 13. Push a **T-pin** through the fuse side (from the inside) at both joints where the bottom of F3A and the 1/8" ply fuse doublers meet. Remove the pins and, with a felt-tip marker, mark a dot where the pins came through the fuse sides.

D 14. Press the **middle fuse top** into place between the fuse sides. Glue the middle fuse top to only the fuse sides. **NOTE: make sure that no glue gets into the joint between the middle fuse top and the aft fuse top.**

### EASY SPORT .40 HATCH

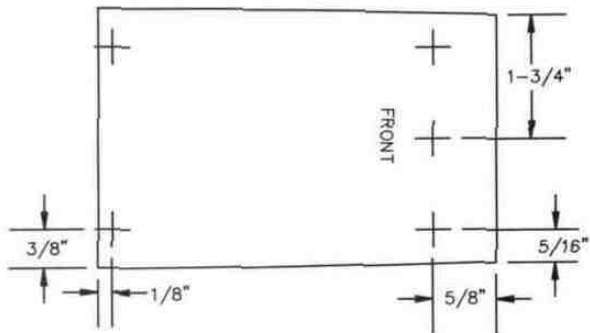

### EASY SPORT .60 HATCH

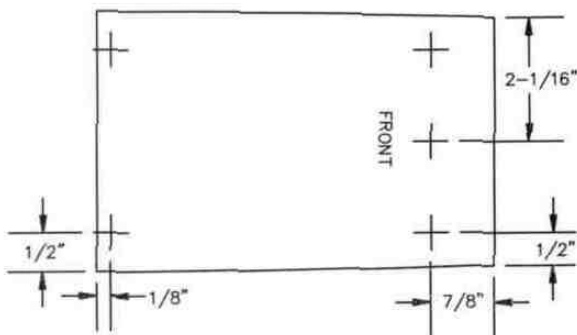

D 15. Center the **fuel tank hatch** in its opening and **tape** in place. Drill a 1/16" hole at each of the five locations shown in the sketch. Remove the hatch and enlarge the holes in only the hatch to 3/32". Secure the hatch with five #2 x 3/8" sheet metal screws, but do not overtighten the screws.

**EXPERT TIP**

Now remove the hatch and apply one drop of thin CA to the "threads" created in the fuselage by the sheet metal screws. Also apply a drop or two of thin CA to each of the holes in the hatch. Any glue that does not soak into the wood must be immediately removed with a tissue. This will harden the wood to prevent crushing when the screws are tightened.

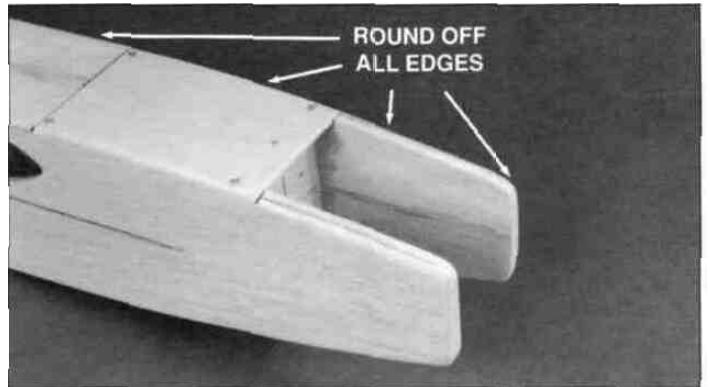

D 16. Starting with coarse (80-grit) sandpaper and finishing with fine (220-grit), round off all corners and edges of the fuselage. Remember to blend the excess nose block material flush with the fuse sides.

**NOTE:** Do not sand off the marks made with the felt-tip marker in step #13.

**Final Assembly**

**Cut center fairing from fuselage**

D 1. Using a felt-tip pen, draw a line from the seam between the middle fuse top and the aft fuse top to the marked pin exit on the fuse side. Draw a line from the marked pin exit to the bottom trailing edge of the wing cutout. Finally, draw a line from the seam between the middle fuse top and the hatch to the front edge of the wing opening.

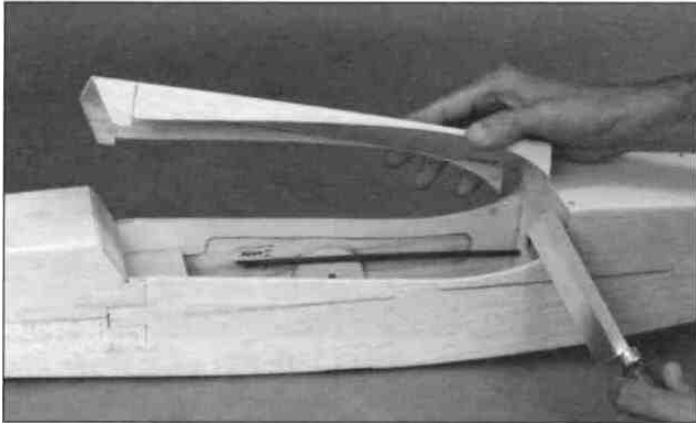
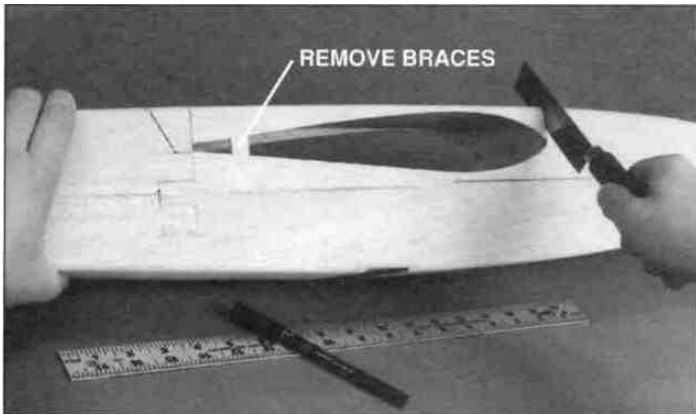

D 2. Using a hobby saw and a hobby knife, cut the two die-cut braces from the wing opening on the Easy Sport 40 only. Then, on the Easy Sport 40 and 60, cut the center fairing free from the fuselage following the lines you drew in the previous step. Use fine (220-grit) sandpaper to clean up the edges of the center fairing and the fuselage. The center fairing should fit the fuselage with approximately 1/32"-1/16" clearance at all of the fuse Joints.

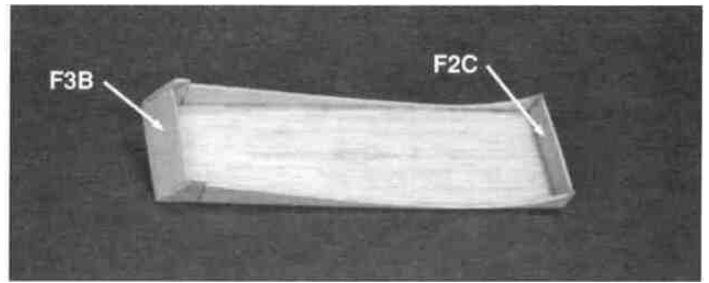
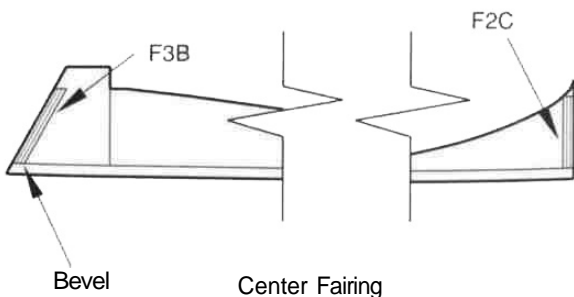

D 3. Test fit the die-cut 1/8" ply **F3B** to the **inside aft** opening of the center fairing. The bottom of F3B is slightly wider than the top and is designated with an arrow. The top fits against the middle fuse top. You will need to bevel the top and bottom edges of F3B to the angle of the middle fuse top with coarse (80-grit) sandpaper to allow it to fit the center fairing properly. Glue in place with medium CA.

D 4. In the same manner that you installed F3B, install **F2C** to the **inside forward** opening of the center fairing with medium CA.

### Mount wing to fuselage

D 1. Test fit the wing in the wing saddle on the fuse. Sand the saddle lightly so that the wing contacts the saddle evenly on both sides.

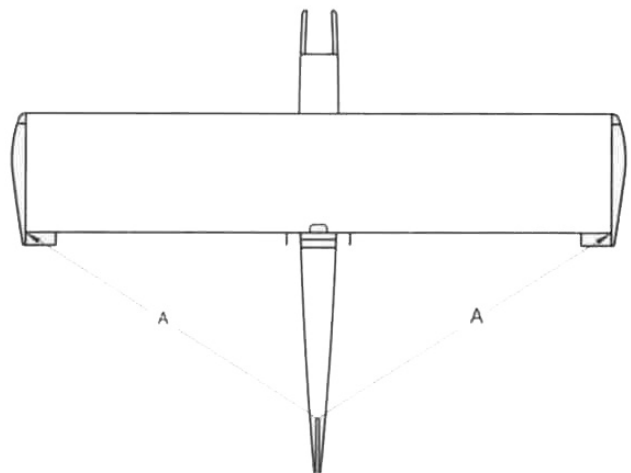

D 2. With the fuse resting on a flat surface, measure down from the bottom of both tip ribs to the flat surface. If the measurements are not equal (within 1/16"), sand the saddle slightly until the wing sits level in the saddle. Hold a string (with one end attached to a pin centered at

the tail) out to a wing tip. Put a piece of tape on the string to mark the intersection of the string and the wing tip. Swing the string over to the other wing tip and check to see if the distances are the same (see diagram). Make slight adjustments to the angle of the wing until the distances from the tail to the tips are equal.

If you are building the **Easy Sport 60** skip steps 3 through 9.

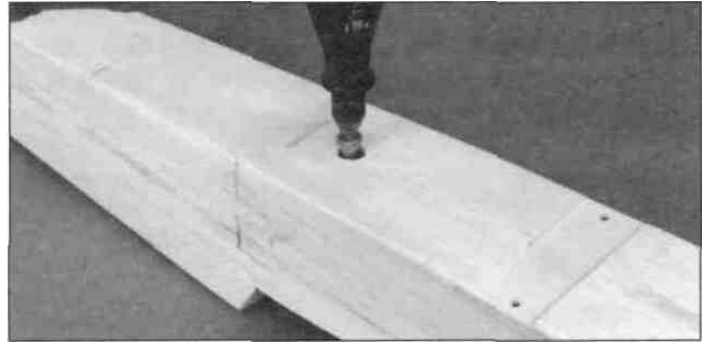

D 5. Enlarge the 1/4" hole in the main fuse bottom to 1/2" to permit the paper tube **wing bolt guide** to pass through. This is best accomplished with a Dremel MultiPro and a cylindrical cutter bit, but may also be done with a round file or a piece of sandpaper wrapped around a small dowel.

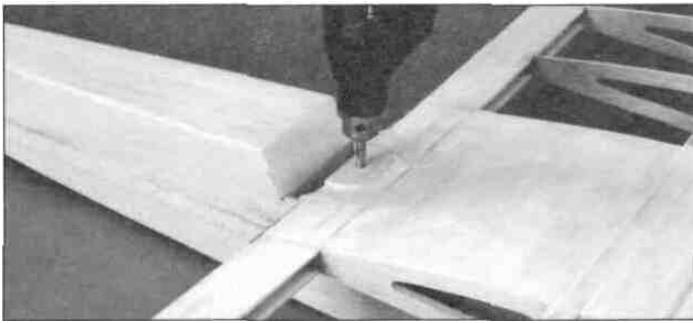

D 3. When you are certain that the wing is aligned and level, securely **tape** the wing to the fuselage so that it doesn't shift. With a 1/4" drill and the drill **perpendicular to the work surface**, drill through the wing bolt plate, wing TE and wing mounting block at the punch mark. Remove the wing from the fuse and redrill through the **wing only** with a **19/64"** drill.

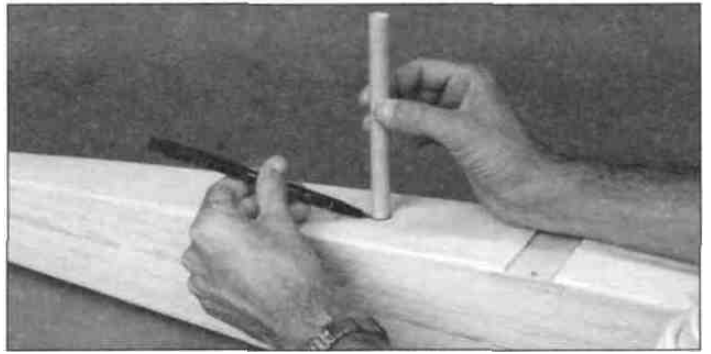

D 6. Insert the wing bolt guide (paper tube) through the fuse bottom far enough so it rests on the underside of the wing mount block. With a felt-tip pen, draw a line around the wing bolt guide as shown. Remove the wing bolt guide and with a hobby saw, cut the guide to length on the line.

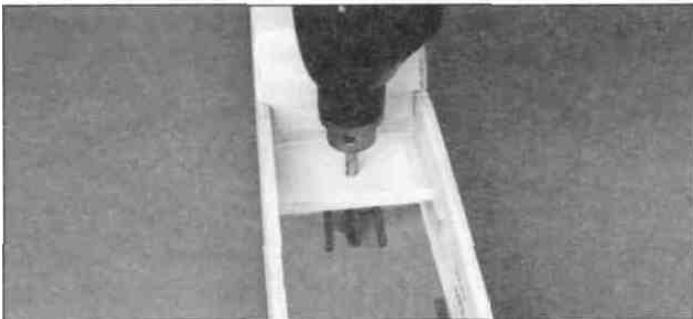

D 4. Reinstall the **1/4"** drill bit into the electric drill and drill **straight** down through the wing mount block and through the fuse bottom. Use a block of wood under the fuse to prevent damage to your work surface.

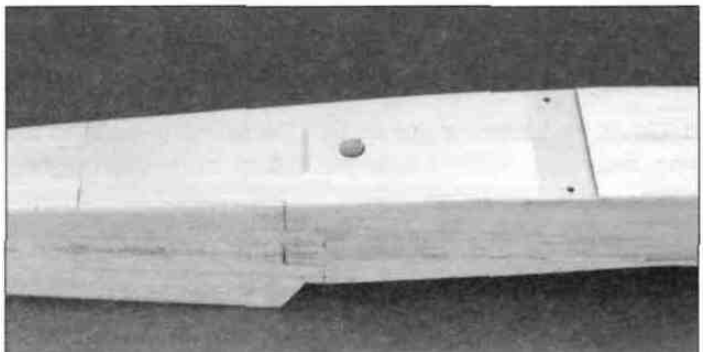

D 7. Insert the 1/4-20 nylon wing bolt through the bottom of the fuse until the bolt head rests on the underside of the wing mount block. Insert the wing **bolt** guide through the bottom of the fuse and seat it around the wing bolt head. Glue the wing bolt guide to the fuse bottom only with medium **CA**.

D 8 Remove the wing bolt. From the inside of the fuse, apply medium CA to the union between the fuse bottom and the wing bolt guide. Sand the wing bolt guide flush with the bottom of the fuse.

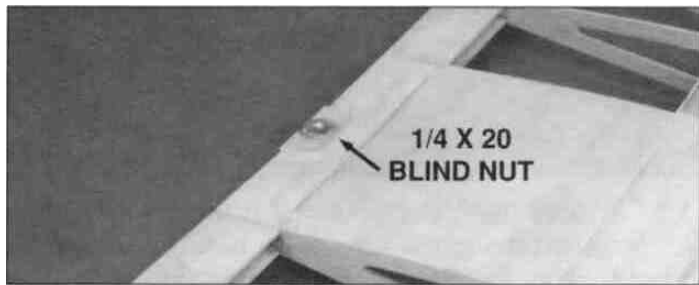

D 9 Install the 1/4-20 blind nut into the top of the wing. With the TE of the wing resting on the work surface, lightly tap the blind nut into place with a hammer. **NOTE:** Due to the angle of the hole, the blind nut flange will not seat fully down onto the wing bolt plate. See the fuse plan side view. Apply epoxy or thick CA under and around the blind nut flange to hold it in place.

**NOTE:** Do not allow the glue to enter the threaded portion of the blind nut.

### STEPS 10 - 13 FOR EASY SPORT 60 ONLY

D 10 While holding the wing securely in position, use a #10 or a 13/64" drill bit to drill through the wing bolt plate, the wing and the wing mounting block in the fuselage. Keep the drill perpendicular to the wing so that the head of the wing bolt will be flush with the wing when tightened down. **Important: Do not allow the wing to shift during this procedure.**

D 11 Remove the wing and tap the holes in the wing mounting block with a 1/4-20 tap.

D 12 Apply several drops of thin CA to the threads in the wing mounting block. **Allow the CA to cure thoroughly**, then re-tap the threads.

D 13 Enlarge the holes through the wing only with a 1/4" drill.

D 14. With a toothpick, apply a little petroleum jelly to the torque rods, where they enter the bearings, to prevent glue from locking them up. Glue the aileron torque rod assemblies into the wing's TE.

**EXPERT TIP**

When gluing in the nylon bearing, do not just smear glue on the bearing and push it into the slot, as most of the glue will be wiped off as it is being pushed in. You must also work some glue into the slot. A good way to do this is to scoop up some epoxy with a plastic soda straw, then pinch the end of the straw, insert it into the slot, and squeeze the straw to force glue into the slot. We recommend 30-minute epoxy for this process. After pushing in the bearing, **wipe away all excess glue with a paper towel dampened with rubbing alcohol.**

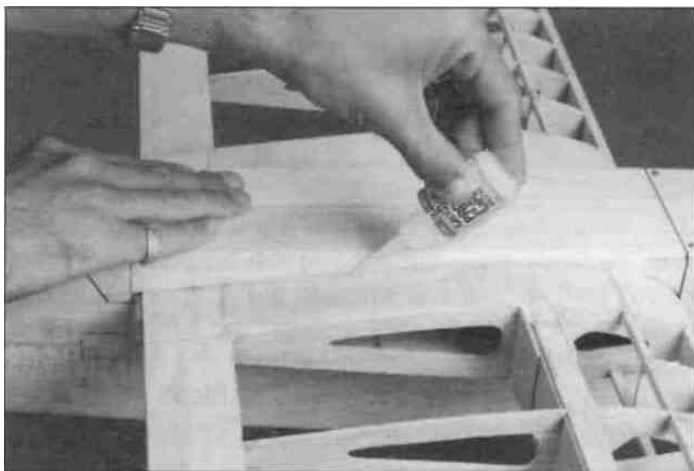

D 15 Attach the wing to the fuse. Test fit the center fairing to the wing as shown. Sand the wing saddle on the center fairing as required for a nice fit between the wing and the center fairing. Carefully align the center fairing on the wing. On the **Easy Sport 40**, tack-glue the fairing to the wing with a few drops of thin CA. Then, **remove** the wing from the fuse and securely glue with thin CA, followed by medium or thick CA where any gaps exist.

On the **Easy Sport 60**, mark the position of the fairing on the wing. Remove the fairing and the wing bolts from the wing. Align the fairing on the wing with the lines. **Tack-glue** the fairing to the wing with a few drops of thin CA. Then **remove** the wing from the fuse and securely glue with thin CA, followed by medium or thick CA where any gaps exist.

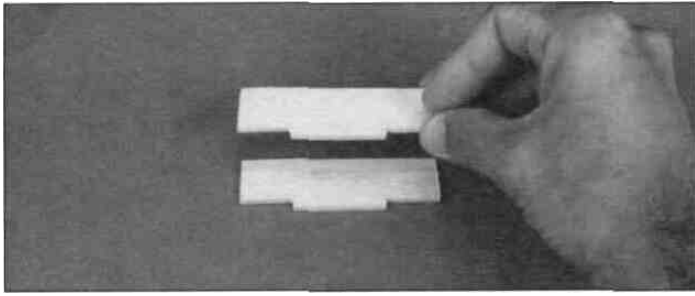

D 16. On the **Easy Sport 40**, locate the two die-cut 1/8" balsa **center fairing filler** (CFF) pieces. Laminate together as shown with medium CA.

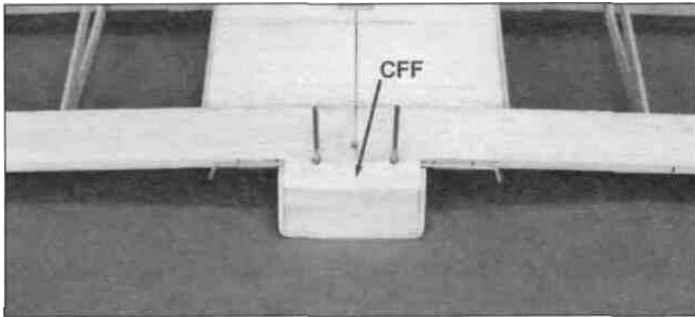

D 17. On the **Easy Sport 40**, trial fit CFF to the underside TE of the wing and sand if necessary. After fitting, glue in place with thin CA.

On the **Easy Sport 60**, cut and fit a center fairing filler (CFF) from a 5/16" x 3/4" x 30" balsa stick.

Skip steps 18 through 22 if you are building the **Easy Sport 40**.

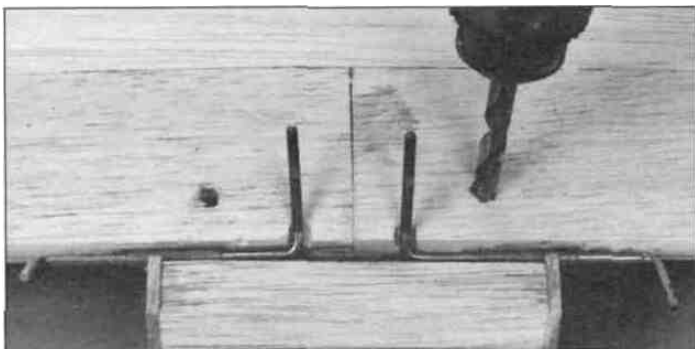

D 18. Using the holes previously drilled in the wing as a guide, drill a 1/4" hole through the wing center fairing. Place a piece of leftover wood under the aft end of the center fairing to prevent damage to your work surface.



D 19. Enlarge the 1/4" holes in the center fairing only to 1/2" to permit the paper tube **wing bolt guide** to pass through. This is best accomplished with a Dremel MultiPro Tool and a cylindrical cutter bit, but may also be done with a round file or a piece of sandpaper wrapped around a small dowel.

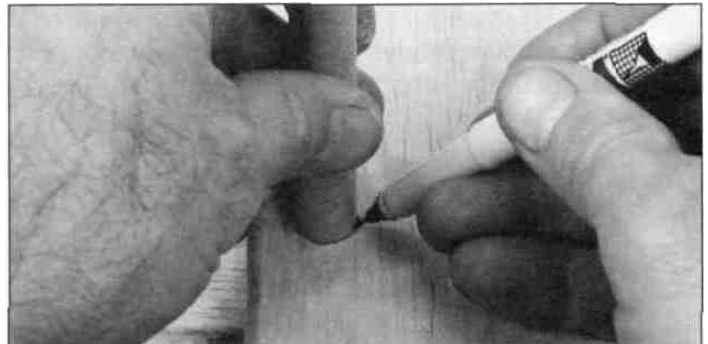

D 20. Insert the wing bolt guide (paper tube) through the center fairing far enough so it rests on the wing bolt plate. With a felt-tip pen, draw a line around the wing bolt guide as shown. Remove the wing bolt guide **and** with a hobby saw, cut the guide to length on the line.

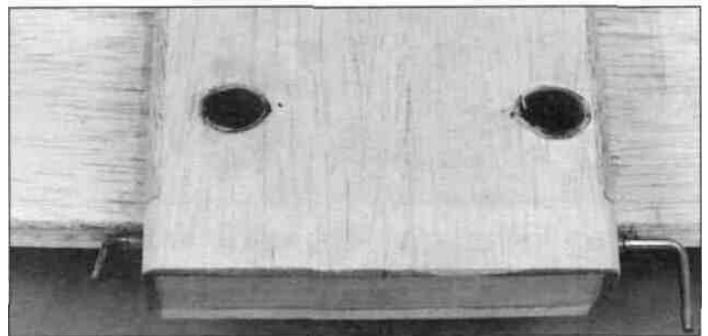

D 21. Insert the 1/4-20 nylon wing bolt through the center fairing until the bolt head rests on the wing bolt plate. Insert the wing bolt guide through the center fairing and seat it around the wing bolt head. Glue the wing bolt guide to the center fairing only with medium CA.

D 22. Remove the wing bolt. Apply medium CA to the joint between the wing bolt plate and the wing bolt guide. Sand the wing bolt guide flush with the center fairing.

## Engine installation

D 1. Cut off the spacer bar from each half of the engine mount, and trim away any remaining bumps to permit the mount halves to slide together

D 2. Fit the two halves of the mount together. Remove the muffler and carburetor from the engine and install your spinner's backplate. Test fit the engine to the mount. Adjust the width of the mounting rails to accommodate the engine without binding or being too loose (a couple of drops of thin CA may be used to tack the two engine mount halves together). Remove the engine. Use four #6 flat washers and four 6-32 x 3/4" Phillips head screws (four #8 flat washers and four 8-32 x 1-1/4" socket head machine screws on the Easy Sport 60) to attach the engine mount to the firewall (do not tighten completely). Center the engine mount on the firewall using the embossed vertical line as a reference.

D 3. Tighten the mount screws so that you can mark the engine screw holes without allowing the rails to move.

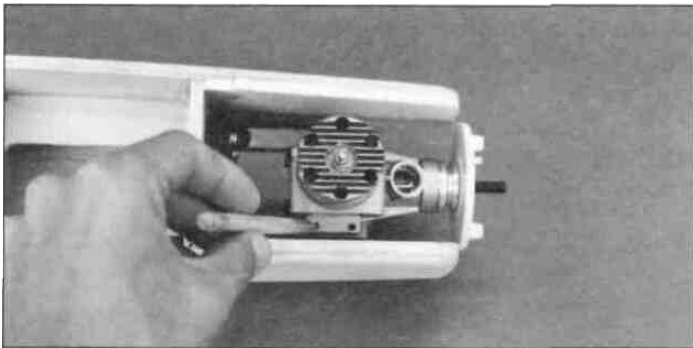

D 4. Place a length of masking tape on each rail of the engine mount (the tape will allow you to see the pencil marks). Position the engine forward or aft on the rails so there is 4-7/8" between the firewall and the back of the spinner backplate (6-1/4" on the Easy Sport 60). Use a sharpened pencil to mark the four engine mounting holes onto the tape. Use a 7/64" drill bit (1/8" on the Easy Sport 60) to drill pilot holes (see tip below) through the rails for the #6 sheet metal screws (#8 sheet metal screws on the Easy Sport 60). Note: You must drill these holes accurately, not allowing the drill bit to wander off the mark. The holes must also be perpendicular to the rails. The best way to achieve this is to use a drill press. If you do not have one, try to borrow a friend's.

**EXPERT TIP**

Before drilling, expert modelers will often make a "dimple" at the location of each hole with a center punch. This dimple prevents the drill bit from "wandering" from its intended location, insuring perfectly spaced holes. If you have access to a center punch tool, we highly recommend using it. If not, a simple substitute may be used, such as a nail. After marking the location of each engine mount hole, remove the engine and engine mount from the model. You may find it easier to clamp the engine mount in a vise for this process, although it's not necessary. Center the point of a nail over one of the marks on the tape. Then, with a hammer, lightly tap the nail. Do this for each of the four marks on the tape. Now, when you drill the holes in the engine mount for the mounting screws, you can rest assured that the holes will be exactly where you wanted them. Simple!

D 5. Remove the tape from the engine mount rails and attach the engine to the rails using four #6 x 3/4" sheet metal screws ( #8 x 1" sheet metal screws on the Easy Sport 60). A drop of household oil on each screw may help when initially installing the engine to the engine mount. Remove the engine from the mount for now.

## Fit fuel tank and fuelproof the fuselage

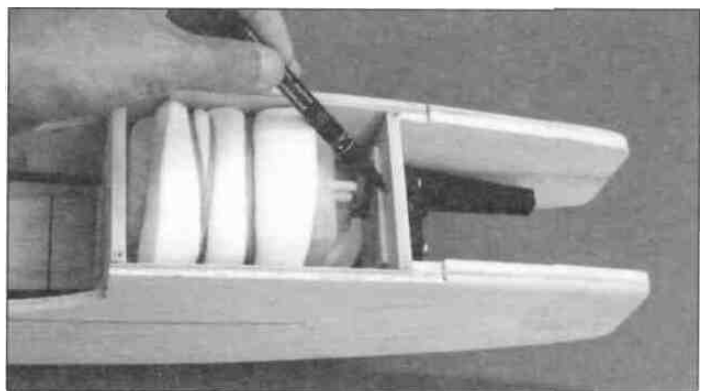

D 1. Assemble your fuel tank according to the manufacturer's instructions. Wrap the fuel tank in latex foam rubber and secure with #64 rubber bands (the foam rubber shields the tank from engine vibration, which can cause the fuel to foam). Fit the assembled tank into the fuel tank compartment and mark the location for the fuel and vent lines on the firewall. Remove the fuel tank and drill through the firewall at the marks with a 15/64" drill.



D 2 Now is the time to fuelproof the front of the model Use fuelproof paint or 30-minute epoxy thinned with alcohol Remove the engine mount and paint the tank floor, fuel tank compartment sides, the bottom of the hatch, the top edges of the fuselage on which the hatch rests, the front and back of the firewall and the engine compartment NOTE Avoid getting the fuelproofer in the threads of the blind nuts on the firewall

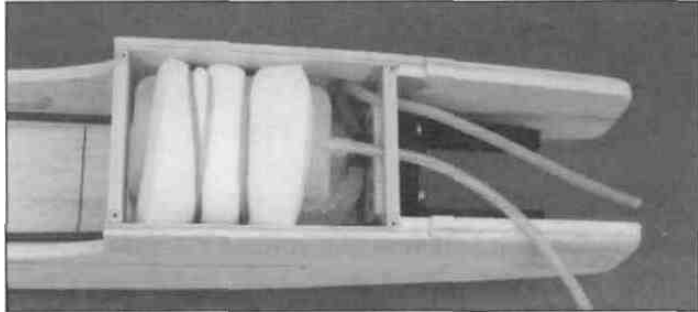

D 3 Once the fuelproofing is dry, reinstall the fuel tank and feed the fuel and vent lines through the firewall into the engine compartment Reinstall the hatch and engine mount.

### Install horizontal stab

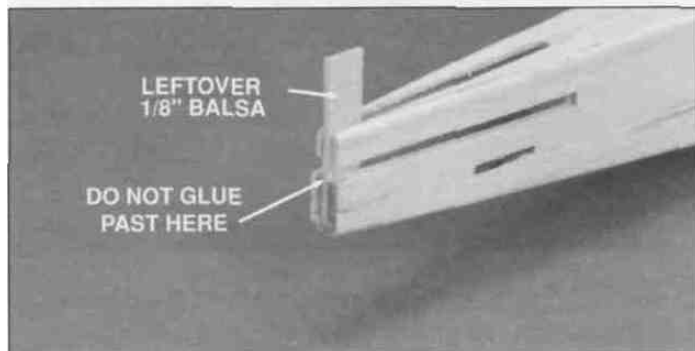

D 1 Glue a leftover piece of 1/8" x 3/4" x 1-1/2" balsa (3/16" x 3/4" x 1-1/2" balsa on the **Easy Sport 60**) in the slot at the tail of the fuse below the horizontal stab slot Cut and sand the filler balsa flush with the lower edge of the horizontal stab slot.

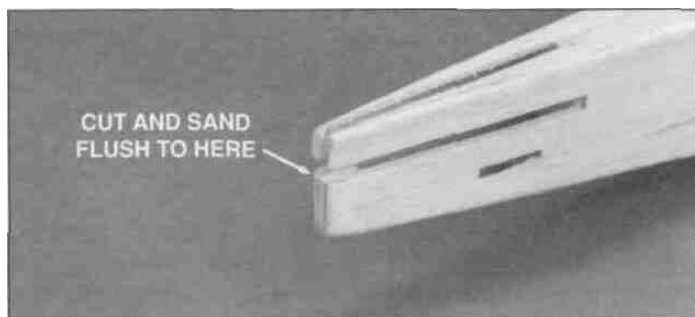

D 2 Sand the aft end of the fuse to a rounded shape as shown.

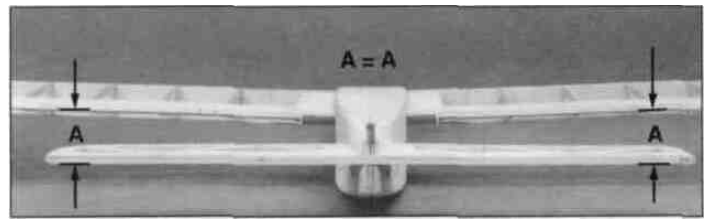

D 3 Attach the wing to the fuse (for reference) and slide the horizontal stab into its slot Center and align the horizontal stab using the same technique that you used to align the wing Stand back 8 to 10 feet and view the model from the rear The stab tips should be equally spaced below the level of the wing If not lightly sand one side of the stab slot to correct the problem Work slowly and check the alignment often Also, the trailing edge must be flush with the aft edge of the fuse.

D 4. When the alignment looks good, use **plenty of 30-minute epoxy** to securely glue the stab in position. Hold the stab in position with pins through the sides of the fuse while the epoxy cures Before the epoxy cures, use a stick to remove any excess epoxy from the center of the stab where the fin will attach (this will insure a smooth, flat mounting surface for the fin) Remove any excess epoxy on the outside with a paper towel dampened with rubbing alcohol, before the epoxy cures.

### Install vertical fin

D 1 Test fit the fin and check the alignment with the centerline of the fuse A straightedge against one side of the fin can be used to check alignment The fin must be perpendicular to the stabilizer Make adjustments to the slot if necessary Also, the trailing edge must be flush with the aft edge of the fuse.

D 2 Use **30-minute epoxy** to glue the fin in position. **Apply epoxy to both inside edges of the fuse as well as the bottom edge of the fin.** Insert the fin until it touches the stab Check the alignment of the fin to the stab with a triangle Then secure it in position with masking tape until the epoxy has cured Remove any excess epoxy before it cures with a paper towel dampened with rubbing alcohol



D 3 Glue the 5/16" shaped balsa **dorsal fin** to the aft fuse top and fin as shown Sand the LE of the dorsal fin to match the LE of the fin Fill any gaps between the dorsal fin and the fin with hobby filler and sand smooth.

## Mount landing gear

**NOTE:** Steps 1, 2 and 3 below pertain to **both the tricycle and taildragger versions**.

Skip to step 3 if you are building the **Easy Sport 60**.

D 1. Test fit the main landing gear wire into the holes in the fuse bottom. In order for the landing gear to lie flat on the bottom of the fuse, it is necessary to remove a little material from the inside edge of the 3/16" holes to allow for the bends in the wire. A round file or knife works well.



D 2. On the Easy Sport 40, fit the two 3/16" main landing gear wires in place on the fuse bottom. Slide the two die-cut 1/8" ply LG aligner strips in place fore and aft of the main landing gear. Sand the edges of the strips if necessary for a good fit. Remove the LG wires and glue the strips in place with thick CA. Sand the aligner strips to blend with the fuse.

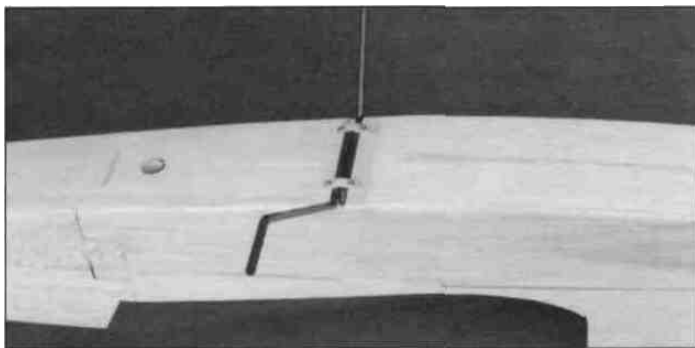

D 3. Position two nylon landing gear straps over the wire LG as shown in the photo. Mark, then drill four 1/16" pilot holes. Use four #2 x 3/8" sheet metal screws to hold down the LG straps. You may "harden" the holes in the same way you did with the hatch.

➔ Perform steps 4 and 5 **only** for the taildragger version

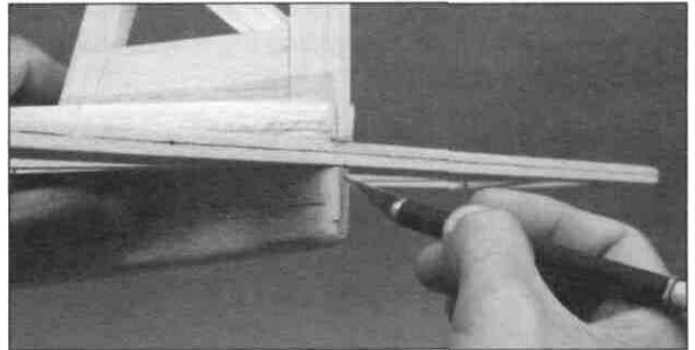

D 4. In the same manner that you cut the slots for the aileron torque rods, cut a vertical slot in the tail of the fuse to accept the tailgear wire nylon bearing (**not** included).

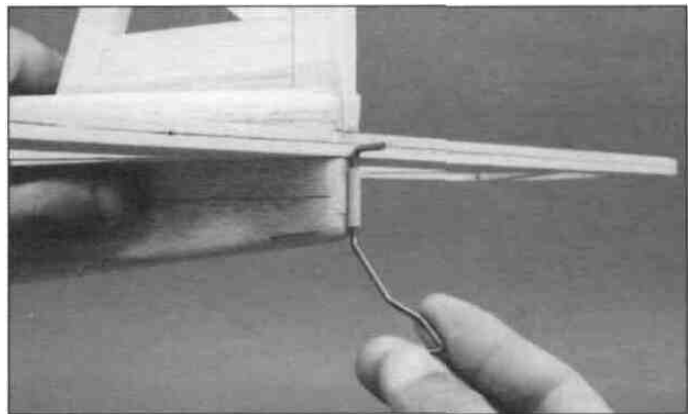

D 5. Test fit the tail gear wire in place, then remove and set aside until the model is covered and ready for final assembly.

**Skip steps 6 -10 if you are building a taildragger.**

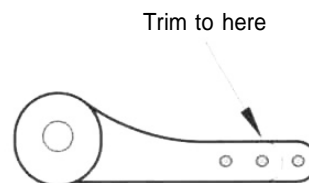

D 6. On the **Easy Sport 40**, refer to the steering arm drawing and cut off approximately 3/16" of the steering arm so it will clear the nose blocks. On both the Easy Sport 40 and 60, drill out the end hole to 5/64" diameter for the pushrod wire clearance.

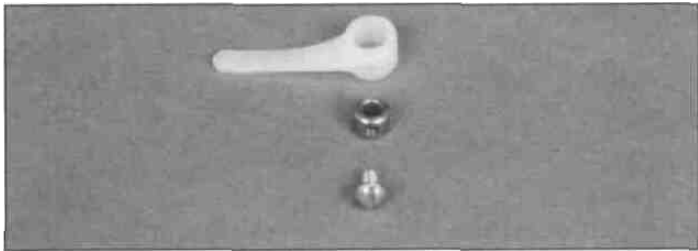

D 7. On the **Easy Sport 40**, align the threaded hole in one 5/32" wheel collar with the small hole in the side of the nylon steering arm. Keeping this alignment, press the wheel collar into the nylon steering arm. On both the Easy Sport 40 and 60, thread the 6-32 x 3/16" machine screw into the steering arm assembly.

### THIS STEP FOR EASY SPORT 60 ONLY

D 8. On the **Easy Sport 60**, remove the fuel tank hatch and insert a 3/16" drill bit through the holes for the nose gear. Twist the drill bit a couple of times to mark the hole location on the bottom sheeting. Use a hobby knife to cut a small hole at the mark. Then, enlarge the hole to 3/8" in the bottom sheeting.

### THIS STEP FOR EASY SPORT 40 ONLY

D 9. On the **Easy Sport 40**, slide the steering arm onto the nosegear wire above the coil. Slide the nose gear wire through the bottom hole in the engine mount. The other 5/32" wheel collar and the 6-32 hex head set screw are used in the center opening of the engine mount (above the steering arm) to retain the nose gear as shown in step 13.

### THIS STEP FOR EASY SPORT 60 ONLY

D 10. On the **Easy Sport 60**, slide the nosegear wire through the bottom sheeting. Then, slide the steering arm on the nosegear wire between the bottom sheeting and the engine mount. The 3/16" wheel collar and the 6-32 hex head set screw are used in the center opening of the engine mount (above the steering arm) to retain the nose gear as shown in step 13.

D 11. On both the **Easy Sport 40** and **60**, position the model upright on its landing gear and adjust the nosegear wire (by sliding the steering arm and wheel collar up or down) until the model sits level or slightly nose down. **Note:** The steering arm needs to be rotated away (approximately 1/2") from the firewall when the axle is aligned for straight ahead steering. This allows the steering pushrod to pull the steering arm far enough for effective steering. For reference, also see the photo at step 13.

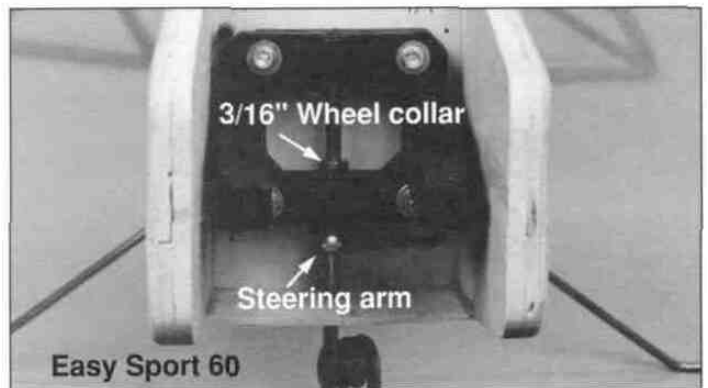

D 12. When everything is aligned and the model is sitting correctly, tighten the 6-32 x 3/16" machine screw on the steering arm tight enough to leave a mark on the nosegear wire. Remove the nosegear from the engine mount and remove the steering arm assembly.

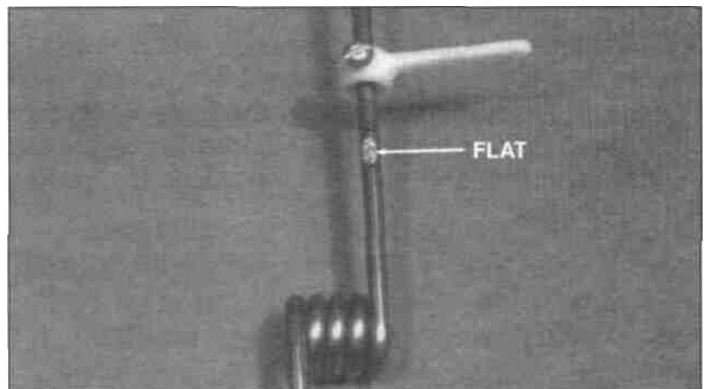

D 13. The reason for marking the nosegear wire in the previous step is so you can locate the spot for a "flat" that will need to be filed into the wire. The procedure for making the flat is described in the next column.

## EXPERT TIP

As mentioned, a flat spot or "flat" is required on the nosegear wire. This flat allows the steering arm set screw to positively lock onto the nosegear wire providing a "no-slip" steering linkage. This step is very important for positive steering control on the ground, and must not be omitted.

A. Remove the steering arm from the nosegear wire and locate the mark left by the 6-32 x 3/16" machine screw. Now, with the mark facing up, clamp the nosegear in a vise and use the side of a flat file or a Dremel MultiPro Tool with a narrow grinding wheel, to make a flat spot at the mark.

B. Reassemble the nosegear and install it into the engine mount. Make sure that the steering arm screw is directly over the flat and tighten. Now your nosegear steering will always remain positive, even on the roughest surface.

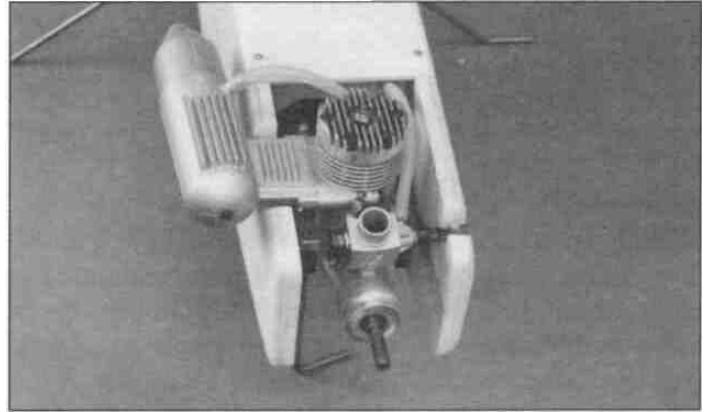

D 2 Cut out any clearance holes or notches you marked in the previous step. Be sure to provide sufficient clearance to allow easy fingertip adjustments of the needle valve. Remount the components removed from the engine. Mount the engine to the engine mount and cut the fuel supply and muffler pressure lines to length.

## Final fit of the engine

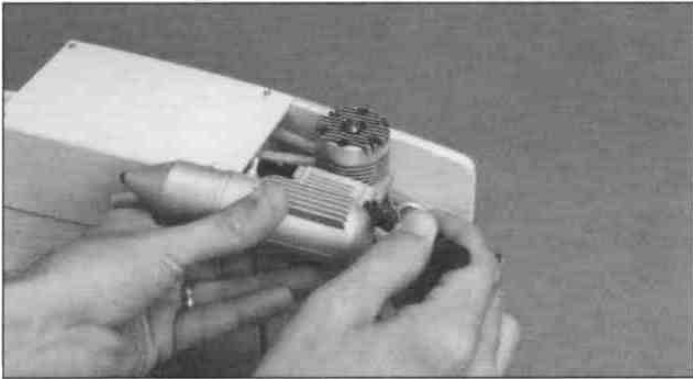

D 1. Temporarily mount the engine to the engine mount with two #6 x 3/4" sheet metal screws for the Easy Sport 40 (#8 x 1" sheet metal screw on the **Easy Sport 60**). Determine if any cutouts are required for clearance around the muffler and needle valve. Mark any cutouts that are required.

**NOTE:** It is best to remove the engine before cutting out the clearance holes, but at least plug the carburetor intake and exhaust port before making dust.

## Install radio and pushrods

The following instructions and photos show a radio installation for a 2-stroke engine and tricycle landing gear configuration.

Carefully study the pushrod layout drawing on page 32 for the version you are building.

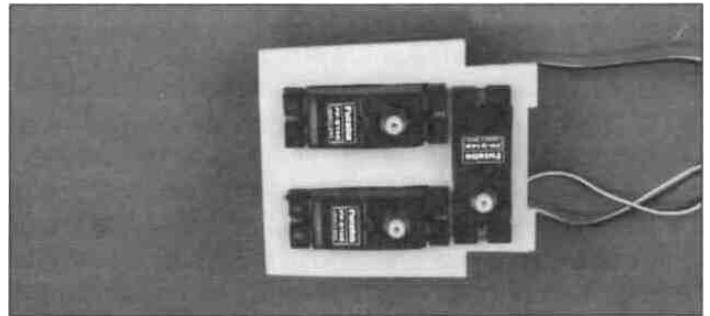

D 1 Place your servos in the die-cut 1/8" ply **servo tray (ST)**. Enlarge the servo openings, if necessary, to accommodate your particular servos.

**NOTE:** If you are installing a 4-stroke engine, the throttle servo output wheel needs to face the **left** side of the fuselage.

D 2 With the servos in position, mark the locations of the servo mounting screws. From a piece of 1/8" scrap ply, cut six 1/4"x1" pieces. Glue one strip on the bottom of the thread. Remove the servos and drill 1/16" holes at the locations for the mounting screws.

D 3 On the **Easy Sport 40**, glue the servo tray and the die-cut 1/8" ply servo tray support (STS) securely in place with medium or thick CA. Add thick CA along the joints to lock the tray in place.

On the **Easy Sport 60**, do not glue the servo tray in place at this time. After the plane is covered and the accessories are installed, the servo tray can be moved forward or aft to adjust the balance point.

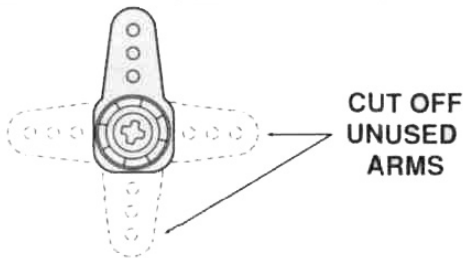
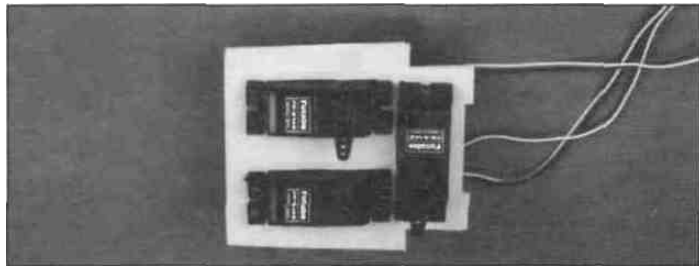

D 4 Mount the servos to the tray with the screws included with your radio. Attach the servo arms to the servos with the hardware supplied with the radio. You may trim the servo arms to the shape required by the particular application (study the photos).

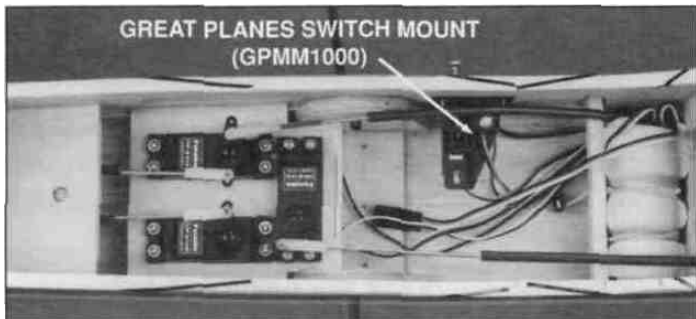

D 5 Install the switch on the side opposite the engine exhaust. We added a Great Planes Switch Mount & Charge Jack (GPMM1000) for convenience and ease of use at the field. Hook up the receiver and receiver battery following the manufacturer's instructions. Wrap the receiver battery and receiver in 1/4" foam rubber, then temporarily secure them in the fuselage. After the model has been balanced, use "popsicle sticks" or leftover balsa glued between the fuselage sides to permanently hold the components in place. Note: The compartment directly under the fuel tank has been designed to house the battery in the event that nose weight is needed for balancing. Instead of adding weight in the form of lead, try moving the battery to this location during balancing.

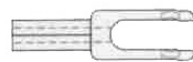
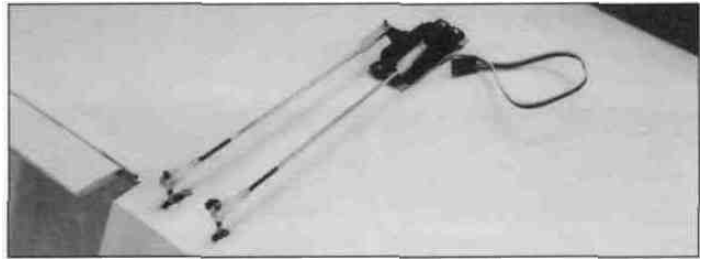
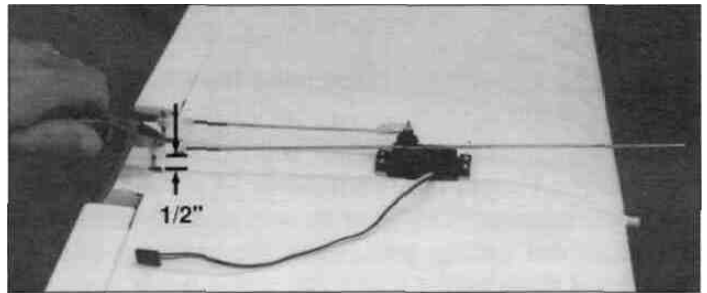

**Swivel Clevis & Swivel**

D 6 Install the aileron servo as shown in the photo. Make sure the servo horn is toward the trailing edge. Assemble the swivel clevises, then thread a 12" wire pushrod at least 13 revolutions onto each of them. Thread the swivels onto the torque rods until they are 1/2" (1/4" on the **Easy Sport 60**) above the trailing edge. Cut off the excess threaded torque rod wire or it may hit the wing mount plate when the wing is mounted on the fuselage.



**Faslink™ Pushrod Keeper**

D 7. Center the ailerons, then mark the pushrods at the point where they meet the holes in the servo arm. Make a 90 degree bend in the wires. Enlarge the servo horn holes with a 5/64" drill bit. Insert the bent wire pushrods into the servo horn. Then secure them with Faslink™ pushrod keepers and cut off the excess rod.



D 8 Cut ten 3/16" bushings from the supplied 6-1/2" inner plastic pushrod. Slide five bushings onto two 36" pushrods that are threaded at one end, spreading them out as shown on the plan. If the bushings are tight and difficult to slide on, cut them to a shorter length. Check the fit on both pushrods, making sure that the bushings won't come out of the outer tube during operation. If they do, they could snag on the outer tube, thereby preventing control movement. If needed, a small drop of thin CA will hold the bushings in position.

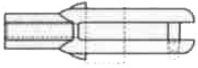

### Clevis and Retainer

D 9. Slide a silicone retainer onto the rear end of a nylon clevis. Thread the nylon clevis 13 revolutions onto a 36" wire pushrod (threaded on one end). With the **rear of the model facing you**, slide the pushrod into the **right hand** pushrod tube until the clevis pin is even with the elevator hinge line.

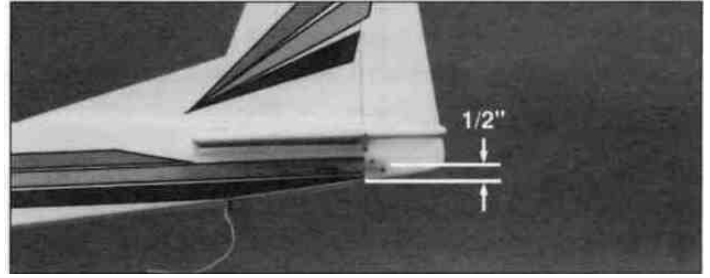
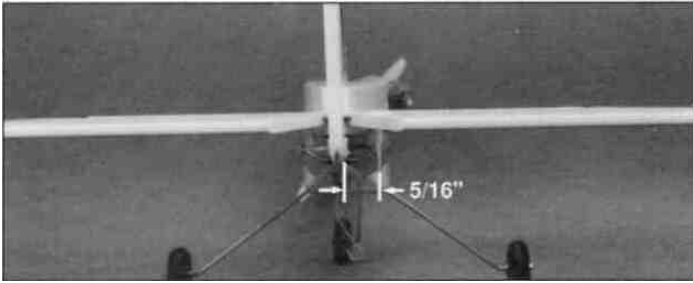

D 11. Assemble a second wire pushrod as you did in step 8. Insert this pushrod into the left hand pushrod tube. Align and mount the control horn 1/2" above the rudder base as you did in step 9.

## Finishing

### Additional fuelproofing

Fuelproofing may be done after covering.

D Fuelproof any external exposed wood (i.e. landing gear plate, etc.).

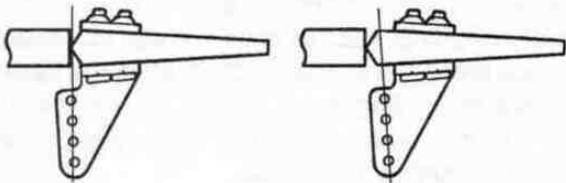

**CORRECT**

**INCORRECT**

D 10. Cut the nut plate from a nylon control horn. Position the horn in line with the clevis (approximately 5/16" from the fuse) with the clevis holes centered on the hinge line. Mark and drill the mounting holes with a 3/32" bit. Attach the control horn to the elevator with two 2-56 x 5/8" screws fastened to the nut plate on the opposite side of the elevator.

**EXPERT TIP**

When drilling the holes in the control surfaces to mount the control horns, it is widely considered "good practice" to harden the holes and the surrounding wood with a couple drops of thin CA.

After the holes are drilled, use a T-pin to lightly perforate the wood in the area that the control horn will mount (top and bottom). Then apply a couple of drops of thin CA to the holes and the perforated areas to harden the wood. After the CA has hardened, sand the surfaces smooth and re-drill the holes. This will insure that when you mount the horns and tighten the screws, the underlying wood will not crush or deform.

### Balance the airplane laterally

**SPECIAL NOTE:** Do not confuse this procedure with "checking the C.G." or "balancing the airplane fore and aft." That very important step will be covered later in the manual.

Now that you have the basic airframe nearly completed, this is a good time to balance the airplane **laterally** (side-to-side). Here is how to do it:

D 1. Temporarily attach the wing and engine (with muffler) to the fuselage.

D 2. With the wing level, lift the model by the engine propeller shaft and the fin post (this **may require two** people). Do this several times.

D 3. If one wing always drops when you lift the model, it means that side is heavy. Balance the airplane by gluing weight to the other wing tip.

**NOTE:** An airplane that has been laterally balanced will track better in loops and other maneuvers.

## Remove the engine and radio

Before proceeding with the next sections, we suggest that you remove the following components from your Easy Sport to facilitate easier finishing.

- D Engine and Engine Mount Assembly
- D Landing Gear
- D Rudder, Elevator, Pushrods and Control Horns
- D Rudder, Elevators and Ailerons
- D Hinges
- D Aileron **servo**
- D Fuselage-mounted Switch Harness
- D Receiver

## Final sanding

Nearly every imperfection in your wood structure will show through the covering material, therefore, before covering, you should make a final check of the entire structure. First fill any gaps with Hobbylite. For structurally important joints, use balsa dust and thin CA. Sand the entire structure smooth using progressively finer grades of sandpaper.



Small dents in your balsa structure can be removed by using an age-old technique passed on from furniture and cabinet-makers.

Simply by applying a small drop of water (real modelers use saliva) to the dent, the wood will swell out and the dent will disappear. Just wait until the swelled areas are dry and sand as usual.

## Covering

Make sure the structure is smoothly sanded, ending with **320-grit** sandpaper. Remove all dust from the structure with a **MonoKote Tack Cloth (TOPR2185)** so the MonoKote film will stick well.

Cover the aircraft with MonoKote film using the sequence. Make sure the MonoKote film is thoroughly stuck down to the structure and all of the edges are sealed. Use a **Top Flite MonoKote Hot Sock** on your covering iron to avoid scratching the MonoKote.

**NOTE:** When covering areas that involve sharp junctions, like the tail and center fairing section of the wing, cut narrow strips (3/8" to 5/8") and apply them in the corners before covering the major surfaces. The larger pieces of MonoKote film will overlap and capture these smaller pieces. This technique also bypasses the need to cut the MonoKote in these areas after it has been applied. **DO NOT, under any circumstances, attempt to cut the covering material after it has been applied to the fin and stab, except around the leading and trailing edges and the tip.** Modelers who do this often cut through the covering and part-way into the balsa stab. This can weaken the stab to the point where it may fail in flight!

## Recommended covering sequence

1. Tail fillet strips as described
2. Rudder left side
3. Rudder right side
4. Bottom of elevators
5. Top of elevators
6. Stab bottom
7. Stab top
8. Fin left side
9. Fin right side
10. Fuse bottom
11. Fuse sides
12. Fuse top
13. Hatch
14. Ends of ailerons
15. Bottom of ailerons
16. Top of ailerons
17. Center fairing fillet strips
18. Forward and aft ends of center fairing
19. Sides of center fairing
20. TE surfaces of wing (at ailerons)
22. Bottom of left wing panel
23. Bottom of right wing panel
24. Top of left wing panel (overlap covering 1/4" at wing LE)
25. Top of right wing panel (overlap covering 1/4" at the LE)
26. Top of center fairing

## Applying trim and decals

There are two ways to make your Easy Sport look like the one depicted on the box ...

1. If you are comfortable and confident about working with iron-on coverings like MonoKote, then by all means cut the trim colors from rolls of MonoKote and apply. The MonoKote colors we used on the prototype were Royal Blue, Dove Grey and Missile Red. The trim colors were bordered with Great Planes 1/16" Black Kwik Stripe Model Stripping Tape.

**EXPERT TIP**

When applying trim MonoKote directly over MonoKote film, there are a few tips that you should be aware of to produce a professional looking finish.

A. To help prevent trapped air bubbles, you should always (wherever possible) pierce the underlying covering. This is best accomplished with a new, sharp hobby knife blade. You don't want to slit the covering, just pierce it (random holes approx. 1/8" apart seem to work best). **Remember: Pierce only the covering directly under the desired trim. Not the entire model!**

B. The temperature of the sealing iron is extremely critical for applying trim MonoKote. Lay the trim piece in the desired position and with the sealing iron set at a **low temperature**, carefully iron down the trim working from the **center to the edges**. Then set the sealing iron to a **high temperature** and seal only the **edges of the trim piece**.

C. If you don't like the idea of ironing down your trim pieces, the makers of MonoKote film also have made available to you **MonoKote Trim Solvent (TOPR6020)**. This liquid is simply brushed onto the area where you would like your trim placed. The solvent chemically activates the adhesive on the trim piece and bonds it in place.

2 If you feel a little intimidated by cutting and ironing down pieces of MonoKote film for your trim on the Easy Sport 40, ask your hobby dealer for the Great Planes Easy Sport Trim Graphics package (GPMQ0405). This is a "Cut, Peel and Stick" type of trim package that faithfully reproduces the prototype trim scheme as shown on the box. This method is extremely easy and gets you in the air the fastest with professional looking results.

### Glue the hinges

D 1 Lay the rudder elevators and ailerons on the plans and mark on the leading edge of each part the locations of the hinges. Now use a sharp hobby knife to cut slits in the covering at the hinge locations. Test fit the hinges to make sure you have found the slots which you previously cut. In the same manner slit the covering at the hinge locations in the wing, stab and fin TE. Remove the hinges and drill a 3/32" hole 1/2" deep in the center of each hinge slot. A high speed Dremel Tool works best for this. If you have to use a drill, clean out the hinge slot

with your hobby knife. Also cut the covering away from the tail gear slot (if you have built a taildragger). Fit the elevator to the stab with the hinges installed. Fit the rudder to the model and with a pencil mark the location where the 1/8" wire elevator Joiner interferes with the rudder. Remove the rudder and, with a hobby knife or file, cut a clearance notch for the 1/8" wire elevator joiner. Reinstall the rudder and check the notch. The notch should be large enough to allow the rudder to move freely throughout its entire range.

### Do step #2 if you have built your Easy Sport as a taildragger:

D 2 Using coarse (80-grit) sandpaper, roughen the horizontal part of the tailgear wire, then clean off the sanded portion of the wire with alcohol or a degreasing solvent. Using a toothpick, apply a small amount of petroleum jelly where the tailgear wire enters the nylon bearing (to prevent glue from getting inside and locking it up).

D 3 Confirm that the hinges are equally positioned in both the elevator and stab, rudder and fin and aileron and wing TE. You may insert a small pin in the center of the hinges to keep them centered. Close the gap to avoid inadvertently gluing the control surfaces together. Remove the pins if you have used any. Apply 6 drops of thin CA to each side of each hinge.

**Note:** When gluing in the nylon tailgear bearing (tail dragger version only) use the "epoxy and soda straw" technique described in the "Install The Aileron Torque Rods" section of this manual. Don't forget to apply a little petroleum jelly to the area where the tail wheel wire enters the bearing - **otherwise the epoxy could lock-up the tail gear.**

### Install pilot (Optional)

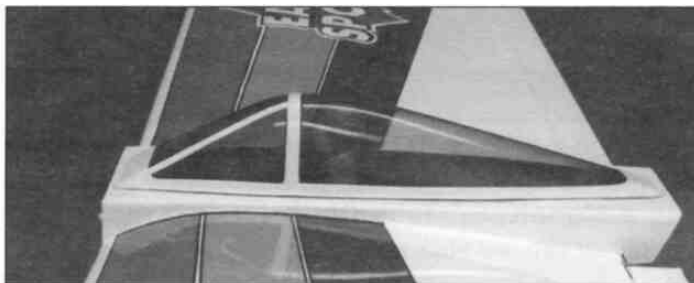

1 If you like, you can black out the cockpit floor or leave it be. The choice is yours. We traced around the trimmed canopy onto a piece of 600 grit sandpaper. We then cut out this sandpaper "floor" and glued it in position with medium CA.



2 Assemble and paint your pilot figure, and attach it to the cockpit floor See tip below

4 We used Pacer Formula 560 to glue the canopy in place This glue is easy to use dries clear, cleans up with water, does not fog butyrate (the canopy material) and produces an extremely strong bond Just apply it to the mounting flange on the canopy and secure in place with tape until the glue dries completely We must warn you against using CA type glues for this task More often than not, CA (especially thin CA) will fog the canopy material, spoiling the look of your completed model

5 We masked all of the sections of the canopy we wanted to remain clear and then sprayed the exposed framework with K&B Epoxy Paint Rather than painting, you may apply Great Planes Kwik Stripe Model Striping Tape directly over the canopy framework The choice is yours



**EXPERT TIP**

We normally suggest to modelers that they drill up through the bottom of the cockpit floor and attach the pilot with a couple of screws (for security). The Easy Sport's center fairing will not allow this procedure. So, in light of this fact, we're going to glue the pilot in place with 6-minute epoxy. But before you just smear some glue on the pilot and set him in place, you must prepare the cockpit floor and the pilot for the gluing process.

A. Position the pilot in the desired location and trace around the base with a felt-tip marker. Next, using a sharp hobby knife, cut away the covering material in the area where the pilot will be mounted. Then, with a 1/16" drill, drill a few randomly spaced holes through the cockpit floor (where the pilot will mount) and through the base of the pilot itself.

B. Now you are ready to glue the pilot in place. Mix up some 6-minute epoxy and apply a liberal amount to the base of the pilot. Position the pilot on the cockpit floor and gently press into place. The epoxy will squeeze through the holes in the cockpit floor and pilot's base to form "epoxy rivets" which are much more structurally sound.

### Wing seating

Apply 1/16" x 1/4" wide foam **wing seating tape** (GPMQ4422) to the wing saddle area to seal the wing/fuse joints



**EXPERT TIP**

An alternate method of sealing the wing/fuse joint is to use "**silicone bathtub sealer.**" This is an excellent method used by many experts because it results in a permanent and nearly perfect wing saddle joint. Briefly, the technique is as follows:

A. Cover the bottom of the wing center section with waxed paper or plastic kitchen wrap. Pull out all wrinkles and tape it to the wing.

B. Squeeze out a bead of silicone sealer onto the wing saddle area of the fuselage.

C. Lay the wing in the saddle and push down gently. The excess silicone sealer will squeeze out.

D. Allow to dry without disturbing for **at least 24 hours.**

E. Remove the tape, then remove the wing from the saddle (leaving the waxed paper or plastic wrap in place).

F. Gently pull the waxed paper or plastic wrap away from the sealer.

G. Using a new single-edge razor blade, trim the sealer flush with the edges of the fuselage.

### Install canopy

1 Using scissors, carefully cut the **canopy** along the trim line The trim line is the more prominent line around the base of the canopy

2 Lightly sand the bottom side of the mounting flange with fine (220-grit) sandpaper

3 Poke **pinholes** (1/8" apart) through the covering material in the area where the canopy will be glued to the fuselage

## Reinstall engine & radio

Reinstall the engine, muffler, propeller, spinner, battery, receiver, servos, control horns, pushrods and main landing gear.

## Install wheels

Install the three 2-1/2" wheels (not included) (3" on the **Easy Sport 60**) using two 5/32" wheel collars (not included) (3/16" wheel collars on the **Easy Sport 60**) for the nose wheel and four 3/16" wheel collars (not included) for the mains. On the Easy Sport 40, the wheel hubs on the main landing wheels may need to be drilled out with a 13/64" drill to allow them to spin freely. Grind or file a flat spot at the point of set screw contact for each of the outer collars. This provides a better area for the set screw to bite and helps keep the wheels in place.

## Balance your model

**NOTE:** This section is VERY important and must NOT be omitted! A model that is not properly balanced will be unstable and possibly unflyable.

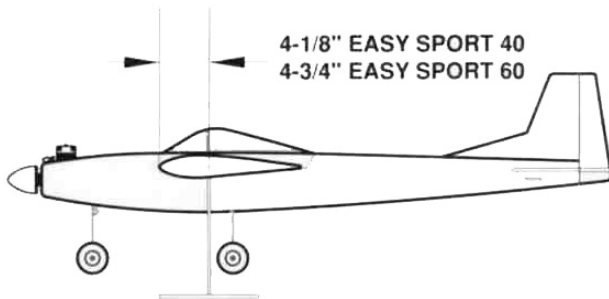

**NOTE:** For more accurate balancing you may build a simple balancing stand using 1/4" dowels and a 1/4" plywood base, as shown in the sketch

1. Accurately mark the balance point on the bottom of the wing on both sides of the fuselage. The balance point is located 4-1/8" back from the leading edge (4-3/4" back from the leading edge on the **Easy Sport 60**). This is the balance point at which your model should balance for your first flights. Later you may wish to experiment by shifting the balance up to 3/8" forward or back to change the flying characteristics. Moving the balance point forward may improve the smoothness and arrow-like tracking, but it may then require more speed for takeoff and make it more difficult to slow down for landing. Moving the balance point aft makes the model more agile with a lighter and snappier "feel" and often improves knife-edge capabilities. In any case please start at the location we recommend and do not at any time balance your model outside the recommended range.

2. On the **Easy Sport 60**, locate the servo tray at the position shown on the plans. On both the Easy Sport 40 and 60, attach the wing to the fuselage. With an empty fuel tank, hold the model at the marked balance point with the stabilizer level.

3. Lift the model. If the tail drops when you lift, the model is "tail heavy" and you must add weight to the nose. If the nose drops, it is "nose heavy" and you must add weight to the tail to balance. On the **Easy Sport 60** the servo tray can be positioned forward or aft along with moving the receiver battery and receiver to balance the model.

**Note:** Nose weight may be easily installed by using a Great Planes Spinner Weight or gluing lead weights to the firewall. Tail weight may be added by using Great Planes (GPMQ4485) "stick-on" lead weights. Later if the balance proves to be OK, you can open the fuse bottom and glue these in permanently.

On the **Easy Sport 40**, first attempt to balance the model by changing the position of the receiver battery and receiver. If you are unable to obtain good balance by doing so, then it will be necessary to add weight to the nose or tail to achieve the proper balance point.

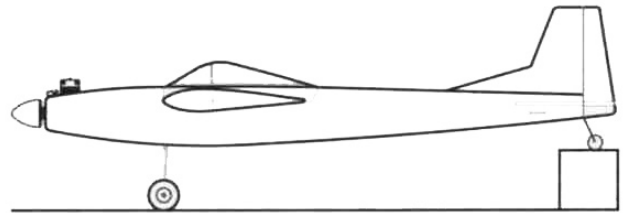

4. If you have built your Easy Sport as a taildragger, you must block up the fuselage, as shown, until the stab is level. Failure to do this before the model is lifted to check for balance will result in an erroneous reading.

5. On the Easy Sport 60, after the airplane is balanced, use medium CA to glue the servo tray to the fuse doublers.

**NOTE:** The balance and surface throws for this aircraft have been extensively tested. We are confident that they represent the settings at which the Easy Sport flies best. Please set up your aircraft to the specifications listed above. If, after a few flights, you would like to adjust the throws to suit your tastes, that is fine.

## Final hookups and checks

1 Make sure the control surfaces move in the proper direction as illustrated in the following sketches.

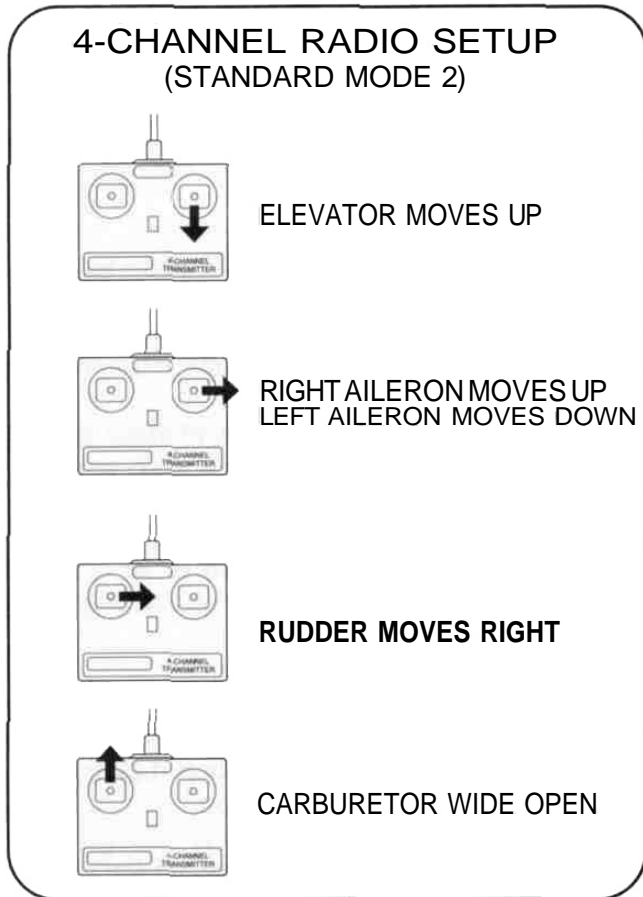

## We recommend the following control surface throws for the Easy Sport 60:

**NOTE:** Throws are measured at the **widest** part of the elevators, rudder, and ailerons.

	HIGH RATES	LOW RATES
<b>ELEVATOR:</b>	5/8" up 5/8" down	7/16" up 7/16" down
<b>RUDDER:</b>	1-1/4" right 1-1/4" left	1" right 1" left
<b>AILERONS:</b>	1/2" up 1/2" down	3/8" up 3/8" down

If your radio does not have "dual rates," set up the plane using throws that are halfway between the high and low rates.

2. Adjust the clevis placement on each control horn as necessary to provide the proper control surface movements as listed above. **Make sure the control surfaces move in the proper direction.**

## We recommend the following control surface throws for the Easy Sport 40:

**NOTE:** Throws are measured at the **widest** part of the elevators, rudder, and ailerons

	HIGH RATES	LOW RATES
<b>ELEVATOR:</b>	1/2" up 1/2" down	3/8" up 3/8" down
<b>RUDDER:</b>	1-1/4" right 1-1/4" left	1" right 1" left
<b>AILERONS:</b>	7/16" up 7/16" down	5/16" up 5/16" down

If your radio does not have "dual rates," set up the plane using throws that are halfway between the high and low rates.

## Preflight

### Balance the propeller

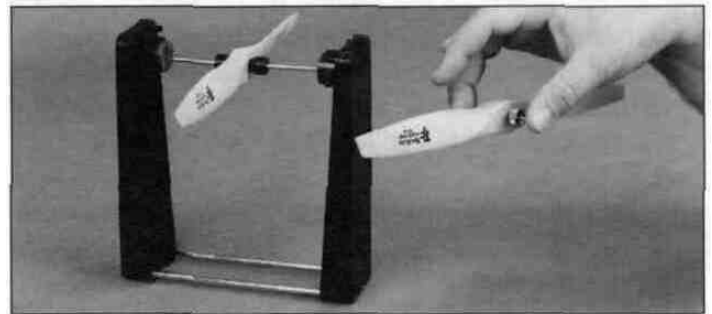

1 Balance your propellers carefully before flying. An unbalanced prop is the single most significant cause of damaging vibration. Not only will engine mounting screws and bolts vibrate out, possibly with disastrous effect, but vibration will also damage your radio receiver and battery. Vibration will cause your fuel to foam, which will, in turn, cause your engine to run rough or quit. We use a Top Flite Precision Magnetic Prop Balancer (TOPQ5700) in the workshop and keep a Great Planes Fingertip Balancer (GPMQ5000) in our flight box.

## ***Charge the batteries***

Follow the battery charging procedures in your radio instruction manual. You should **always** charge your transmitter and receiver batteries the night before you go flying, and at other times as recommended by the radio manufacturer.

## ***Find a safe place to fly***

The best place to fly your R/C model is an AMA (Academy of Model Aeronautics) chartered club field. Ask your hobby shop dealer if there is such a club in your area and join. Club fields are set up for R/C flying and that makes your outing safer and more enjoyable. The AMA also can tell you the name of a club in your area. We recommend that you Join AMA and a local club so you can have a safe place to fly and have insurance to cover you in case of a flying accident (The AMA address is listed on page 3 of this instruction book)

If a club and its flying site are not available, you need to find a large, grassy area at least 6 miles away from any other R/C radio operation, like R/C boats and R/C cars and away from houses, buildings and streets. A schoolyard may look inviting but it is too close to people, power lines and possible radio interference.

## ***Ground check the model***

If you are not thoroughly familiar with the operation of R/C models, ask an experienced modeler to check to see that you have the radio installed correctly and that all the control surfaces do what they are supposed to. The engine operation also must be checked and the engine "broken-in" on the ground by running the engine for at least two tanks of fuel. **Follow the engine manufacturer's recommendations for break-in.** Check to make sure all screws remain tight, that the hinges are secure and that the prop is on tight.

## ***Range check the radio***

Wherever you fly, you need to check the operation of the radio before every time you fly. This means with the transmitter antenna collapsed and the receiver and transmitter on, you should be able to walk at least 100 feet away from the model and still have control. Have someone help you. Have them stand by your model and, while you work the controls, tell you what the various control surfaces are doing.

Repeat this test **with the engine running** at various speeds with an assistant holding the model. If the control surfaces are not always acting correctly, **do not fly!** Find and correct the problem first.

## ***Engine safety precautions***

**NOTE: Failure to follow these safety precautions may result in severe injury to yourself and others.**

Keep all engine fuel in a safe place, away from high heat, sparks or flames, as fuel is very flammable. Do not smoke near the engine or fuel, and remember that the engine exhaust gives off a great deal of deadly carbon monoxide. Therefore **do not run the engine in a closed room or garage.**

Get help from an experienced pilot when learning to operate engines.

Use safety glasses when starting or running engines.

Do not run the engine in an area of loose gravel or sand, as the propeller may throw such material in your face or eyes.

Keep your face and body as well as all spectators away from the plane of rotation of the propeller as you start and run the engine.

Keep items such as these away from the prop: loose clothing, shirt sleeves, ties, scarfs, long hair or loose objects (pencils, screw drivers) that may fall out of shirt or jacket pockets into the prop.

Use a "chicken stick" device or electric starter; follow instructions supplied with the starter or stick. Make certain the glow plug clip or connector is secure so that it will not pop off or otherwise get into the running propeller.

Make all engine adjustments from **behind** the rotating propeller.

The engine gets hot! Do not touch it during or after operation. Make sure fuel lines are in good condition so fuel will not leak onto a hot engine causing a fire.

To stop the engine, cut off the fuel supply by closing off the fuel line or follow the engine manufacturer's recommendations. Do not use hands, fingers or any body part to try to stop the engine. Do not throw anything into the prop of a running engine.

# AMA Safety Code

(Excerpt)

Read and abide by the following Academy of Model Aeronautics Official Safety Code:

## General

1 I will not fly my model aircraft in sanctioned events, air shows, or model flying demonstrations until it has been proven to be airworthy by having been previously successfully flight tested.

2. I will not fly my model aircraft higher than approximately 400 feet within 3 miles of an airport without notifying the airport operator I will give right of way to, and avoid flying in the proximity of, full scale aircraft Where necessary an observer shall be used to supervise flying to avoid having models fly in the proximity of full scale aircraft.

3 Where established, I will abide by the safety rules for the flying site I use, and I will not willfully and deliberately fly my models in a careless, reckless and/or dangerous manner.

7. I will not fly my model unless it is identified with my name and address or AMA number, on or in the model

9 I will not operate models with pyrotechnics (any device that explodes, burns, or propels a projectile of any kind).

**Read the complete code for additional requirements.**

## Radio control

1. I will have completed a successful radio equipment ground check before the first flight of a new or repaired model.

2. I will not fly my model aircraft in the presence of spectators until I become a qualified flier, unless assisted by an experienced helper.

3.1 will perform my initial turn after takeoff away from the pit or spectator areas, and I will not thereafter fly over pit or spectator areas, unless beyond my control

4. I will operate my model using only radio control frequencies currently allowed by the Federal Communications Commission...

# Flying

The Great Planes Easy Sport is a great flying sport airplane that flies smoothly and predictably, yet is highly maneuverable It does not, however, have the self-recovery characteristics of a primary R/C trainer; therefore, you must either have mastered the basics of R/C flying or obtained the assistance of a competent R/C pilot to help you with your first flights.

## Takeoff

If you have dual rates on your transmitter, set the switches to "high rate" for takeoff, especially when taking off in a crosswind Although the Easy Sport has great low speed characteristics, you should always build up as much speed as your runway will permit before lifting off, as this will give you a safety margin in case of a "flame-out." If you have built the taildragger version, please take note When you first advance the throttle and the tail begins to lift, the plane will start to turn left (a characteristic of all "taildraggers") Be ready for this, and correct by applying sufficient right rudder to hold it straight down the runway The left-turning tendency will quickly go away as soon as the tail is up and the plane picks up speed When the plane has sufficient flying speed, lift off by smoothly applying a **little** up elevator (don't "jerk" it into a vertical climb!), and climb out gradually.

## Flying

We recommend that you take it easy with your Easy Sport for the first several flights and gradually "get acquainted" with this fantastic airplane as your engine gets fully broken-in Add and practice one maneuver at a time, learning how she behaves in each one For ultra-smooth flying and normal maneuvers, we recommend using the "low rate" settings as listed on page 51 If you notice any "sluggishness" in the way your Easy Sport handles, it is probably a result of not enough speed, in which case you should install a propeller with increased pitch.

**CAUTION (THIS APPLIES TO ALL R/C AIRPLANES):** If, while flying, you notice any unusual sounds, such as a low-pitched "buzz", this may be an indication of control surface "flutter." Because flutter can quickly destroy components of your airplane, any time you detect flutter you must immediately cut the throttle and land the airplane! Check all servo grommets for deterioration (this will indicate which surface fluttered), and make sure all pushrod linkages are slop-free. If it fluttered once, it will probably flutter again under similar circumstances unless you can

eliminate the slop or flexing in the linkages. Here are some things which can result in flutter: excessive hinge gap; not mounting control horns solidly; sloppy fit of clevis pin in horn; elasticity present in flexible plastic pushrods; side-play of pushrod in guide tube caused by tight bends; sloppy fit of pushrod wire in servo arm; insufficient glue used when gluing in the elevator joiner wire or aileron torque rod; excessive flexing of aileron, caused by using too soft balsa aileron; excessive "play" or "backlash" in servo gears; and insecure servo mounting.

### Landing

When it's time to land, fly a normal landing pattern and approach. If you find that it lands a little fast, you might try dialing in a few clicks of up elevator when you cut the throttle on the downwind leg of the landing pattern. This will automatically help to bleed off some of the speed. If your Easy Sport is built straight and true, you'll find that you can really flare it out for slow, nose-high, full-stall landings without fear of tip stalling

**Have a ball, but always stay in control and fly in a safe manner.**

GOOD LUCK AND GREAT FLYING!

SEE THE FULL LINE OF GREAT PLANES AIRPLANES AND AIRPLANE ACCESSORIES AT YOUR HOBBY DEALER.

WE HOPE YOU WILL SELECT ANOTHER "GREAT PLANE" AS YOUR NEXT PROJECT. THANK YOU!



Fun-1.....GPMA0490

Climb, "hang" and "hot dog" like a Fun Fly champ! Extra light, for quick, rocketing climbs and long, leisurely glides. Extra-wide control surfaces let you roll faster and loop tighter than conventional craft. Quick enough for snap rolls and stable enough at slow speeds to hit "spot" landings on the nose.



F-15 Eagle.....GPMA0438

Jet-like looks and thrills for anyone who's built and flown a trainer. Modeled after the USAF F-15 Eagle - the fighter that paved the way to victory in Operation Desert Storm. Featured Auto-Lock™ engineering makes building straight, strong and true structures easier than ever before. Performs high-speed passes, victory rolls and other jet maneuvers Powered by a front-mounted engine and prop.

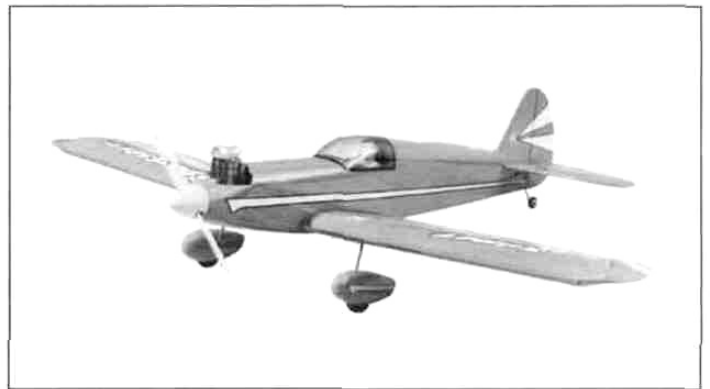

Super Sportster 40.....GPMA0200

Acrobatic excellence that stands the test of time. This airplane flies like a trainer with throws reduced and it flies avalanches in a heartbeat with throttle and throws advanced. Symmetrical airfoil features a blunt leading edge for rock-solid handling at slow speeds. Sleek, sporty looks hide sturdy, interlocking wood parts.



# 2-VIEW DRAWING

Use This Diagram To Plan Your Trim Scheme.

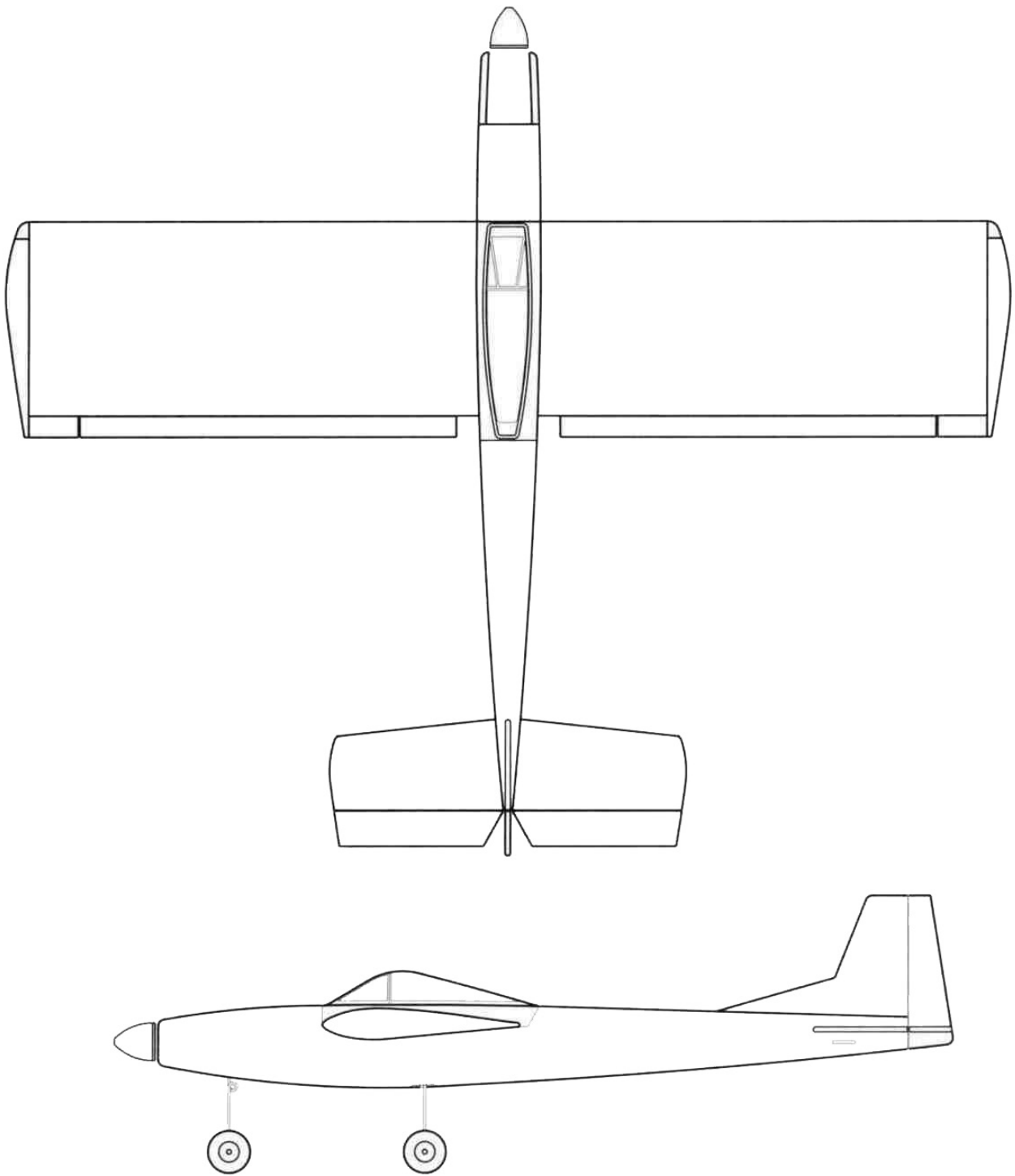

**Use** copies of this page to plan your trim scheme