

SPECTRA

INSTRUCTIONS

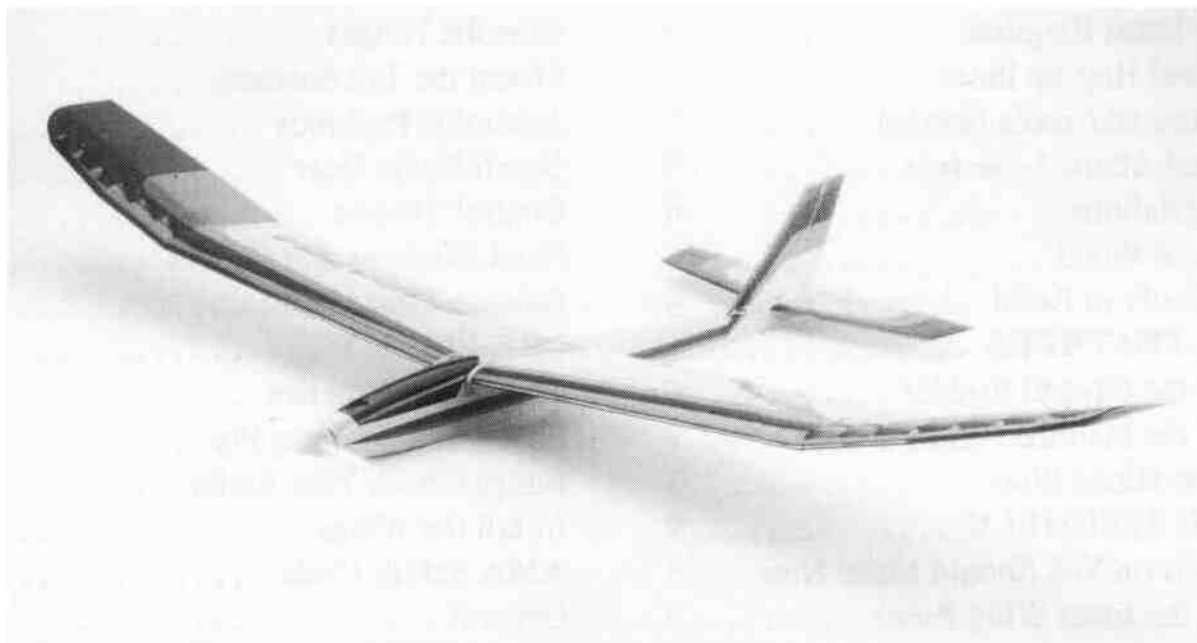

READ THROUGH THIS INSTRUCTION BOOKLET IN ITS ENTIRETY BEFORE BEGINNING ASSEMBLY. IT CONTAINS IMPORTANT INSTRUCTIONS AND WARNINGS CONCERNING THE BUILDING AND USE OF THIS MODEL.

WARNING! THIS IS NOT A TOY!

The model you will build from this kit is not a toy! It is capable of serious bodily harm and property damage. **IT IS YOUR RESPONSIBILITY AND YOURS ALONE** -- to build this kit correctly, properly install all R/C components and to test the model and fly it only with experienced, competent help, using common sense and in accordance with all safety standards as set down in the Academy of Model Aeronautics Safety Code. It is suggested that you join the AMA and become properly insured before you attempt to fly this model. **IF YOU ARE JUST STARTING R/C MODELING, CONSULT YOUR LOCAL HOBBY SHOP OR WRITE TO THE ACADEMY OF MODEL AERONAUTICS TO FIND AN EXPERIENCED INSTRUCTOR IN YOUR AREA.**

Academy of Model Aeronautics
5151 East Memorial Drive
Muncie, IN 47302-9252



PO BOX 788

Urbana, Illinois 61801

217/3988970

TABLE OF CONTENTS

Die Patterns	3	Final Sanding	25
INTRODUCTION	4	Covering	25
Precautions	4	Checking for Warps	26
Other Items Required	4	Glue the Hinges	26
Optional Hop-up Items	5	Mount the Tail Surfaces	26
Supplies and Tools Needed	5	Assemble Pushrods	27
A Word About Adhesives	5	Install Radio Gear	27
Abbreviations	6	Control Throws	30
Types of Wood	6	Final Hookups and Checks	30
Get Ready to Build	6	Balance Your Model	31
TAIL FEATHERS	6	PRE-FLIGHT	31
Build the Fin and Rudder	6	Charge the Batteries	31
Build the Stabilizer and Elevator	7	Find a Safe Place to Fly	31
Cut the Hinge Slots	8	Range Check Your Radio	32
WING ASSEMBLY	9	Install the Wings	32
A Decision You Should Make Now ...	9	AMA Safety Code	32
Build the Inner Wing Panel	9	General	32
Build the Outer Wing Panel	13	Radio Control	32
Join the Inner and Outer Wing Panels .	15	FLYING	32
Final Wing Assembly	16	Hand Launched Trim Flights	32
FUSELAGE ASSEMBLY	19	Your First Flight	33
Assemble Fuselage Sides	19	THERMAL FLYING	34
Frame-up the Fuselage	20	Facts About Thermals	34
Assemble the Canopy	22	Thermal Soaring	34
Install the Motor	24	Some Important Soaring Tips	35
FINAL ASSEMBLY	25	Dynamic Braking Modification	35
Balance the Airplane Laterally	25	PARTS LIST	36

Please inspect all parts carefully before starting to build! If any parts are missing, broken or defective, or if you have any questions about building or flying this airplane, please call us at (217) 398-8970 and we'll be glad to help. If you are calling for replacement parts, please look up the part numbers and the kit identification number (stamped on the end of the carton) and have them ready when calling.

DIE PATTERNS

Do not punch out die-cut parts until you are ready to use them!

SPECFO1

2 PER KIT

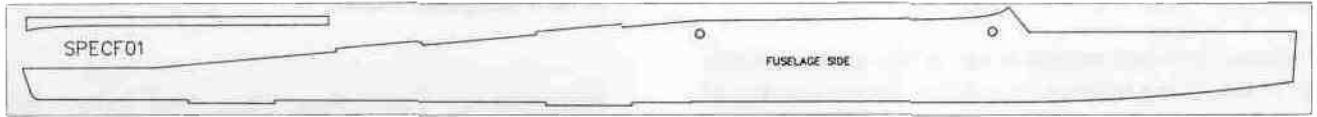

BALSA 3/32" X 3-1/4" X 38-1/2"

SPECFO6

1 PER KIT



BALSA 1/8" X 3" X 8 7/8"

SPECFO2

2 PER KIT

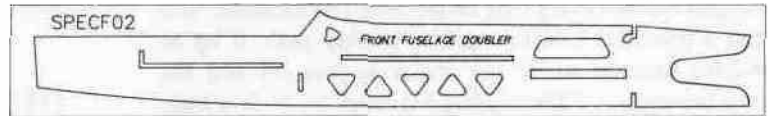

BALSA 1/16" X 3 1/4" X 23 7/8"

SPRTW07

2 PER KIT

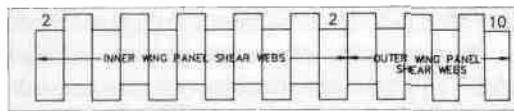

BALSA 1/16" X 3" X 15"

SPECFO3

1 PER KIT

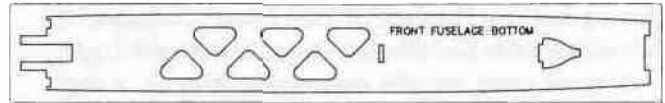

PLY 1/8" X 3" X 19"

SPECFO5

1 PER KIT



SPRTF04

1 PER KIT

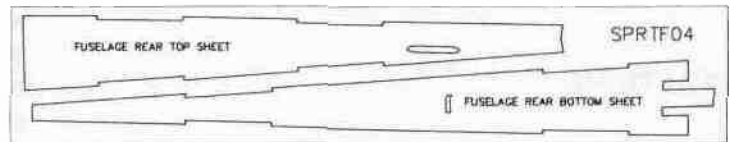

BALSA 3/32" X 4" X 21"

SPECF13

2 PER KIT

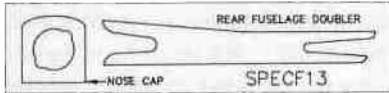

BALSA 1/16" X 2 5/8" X 11 7/6"

SPECFO7

1 PER KIT

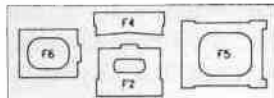

PLY 1/8" X 2 7/8" X 7 7/8"

SPRTW02

2 PER KIT

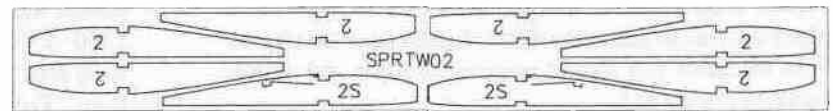

BALSA 1/16" X 3" X 23 7/8"

SPRTW03

2 PER KIT

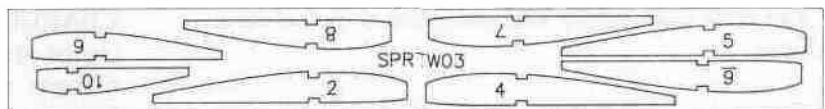

BALSA 1/16" X 3" X 23 7/8"

SPRTS01

1 PER KIT

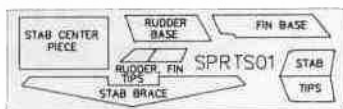

BALSA 3/16" X 3" X 9-7/8"

SPRTW08

1 PER KIT

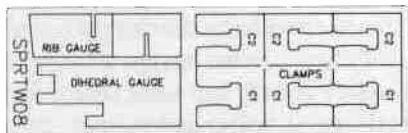

PLY 1/8" X 3 7/8" X 1 1/8"

SPRTW05

NOT USED IN SPEC KIT 1 PER KIT



PLY 1/16" X 3 3/8" X 1 1/8"

SPRTW01

1 PER KIT

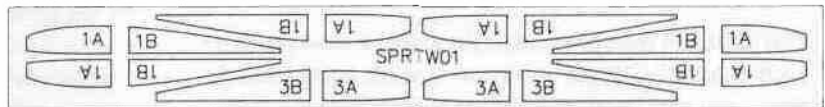

BALSA 1/8" X 3" X 23 7/8"

SPRTW04

1 PER KIT

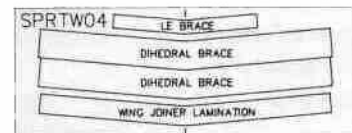

PLY 1/8" X 3 3/4" X 10 1/2"

SPRTW06

1 PER KIT

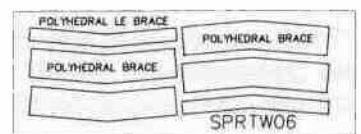

PLY 1/32" X 3 1/4" X 9 3/4"

INTRODUCTION

Congratulations! You are about to enter one of the most exciting realms of radio control flying - Electric Powered Sailplanes.

Electric powered soaring is one of the most enjoyable types of R/C flying because it combines the convenience of being able to fly from almost any small field with the challenge of staying aloft for long periods of time. There is something very gratifying about defying gravity and being able to gain altitude using only nature's own air currents. The Spectra's powerful Goldfire motor quickly pulls it up to thermaling altitude where the motor is shut off and the Spectra becomes a "Thermaling Machine". With a little practice, you will be able to soar for hours in a **single** flight!

We would like to take this chance to thank you for purchasing the Great Planes SPECTRA Electric Sailplane. It has been designed to give you many hours of enjoyable flight, and we spent many months engineering it to be a very enjoyable kit to build. If you have any comments or suggestions feel free to share them with us.

PRECAUTIONS

1. You must build the plane **according to the plans and instructions**. Do not alter or modify the model as doing so may result in an unsafe or un-flyable model. In a few cases the plans and instructions may differ slightly from the photos. In those instances you should assume the plans and written instructions are correct
2. You must take time to **build** straight, true and strong.
3. You must use a proper R/C **radio** that is in first class **condition**.
4. You must properly **install** all R/C and other components so that the model operates properly on the ground and in the air.
5. You must **test** the operation of the model before the first and each successive flight to insure that all equipment is operating, and you must make certain that the model has remained structurally sound. Be sure to check the nylon clevises often, and replace if they show signs of wear.
6. You must fly the model **only with the competent help** of a well experienced R/C pilot if you are not already an experienced and knowledgeable R/C pilot at this time.

Note: We, as the kit manufacturer, can provide you with a top quality kit and great instructions, but ultimately the quality and "fly-ability" of your finished model depends on how **you** build it; therefore, we cannot in any way guarantee the performance of your completed model, and no representations are expressed or implied as to the performance or safety of your completed model.

Remember: Take your time and follow directions to end up with a well-built model that is straight and true.

OTHER ITEMS REQUIRED

RADIO - A Radio having at least 2 channels is required to control the SPECTRA (a third channel is required for throttle control). Standard size servos can be used without any problem but a 250 mAh receiver battery is recommended but not required. Make sure that the radio is on an "Aircraft Only" frequency.

FLIGHT BATTERY - A 6 or 7 cell battery with a "Kyosho" type connector is required to power the electric motor. We recommend you use a 7 cell battery as it offers much higher performance than a 6 cell battery. The capacity (mAh) of the battery can be anywhere from 800 mAh to 1700 mAh. For general flying a 1200 -1700 mAh 7 cell battery will provide good power, good motor duration, and good flight performance. For contest flying an 800 - 900 mAh 7 cell battery will provide a shorter motor duration but its lighter weight will enable the SPECTRA to climb quicker and soar better. A 1200 -1700 mAh 6 cell battery should be used if you just want to fly around with the motor on continuously. If your batteries have "Tamiya" style connectors, you'll have to change the connector on the wiring harness, or purchase a Kyosho #6195 adaptor.

CHARGER - A quick (15-20 Minute) charger is required to charge your flight battery. These chargers come in many different styles (DC, AC/DC, Timed, Peak, Temperature Sensing, etc.).

The most inexpensive charger will be a DC Quick Charger with a 15 - 30 minute timer. This type of charger will work fine but you should never leave the charger unattended while charging as the timers are not always reliable. If the timer sticks or the battery already had some charge in it, the battery could be over charged, heat up and explode. If you use this type of charger, check the temperature of the battery every couple of minutes and turn the charger off as soon as the battery starts getting warm.

The best type of chargers are the "Peak" chargers. They constantly measure the voltage of the battery being charged and when the voltage starts to drop (as the voltage of a Nicad battery will do when it is fully charged) it will shut off. All

you have to do is connect the battery, push one button and come back when its done.

OTHER ITEMS:

Iron-on Covering Material-2 rolls (we recommend Monokote for the wing because of its superior strength)
Latex Foam Rubber Padding (1/4" thick)
#64 Rubber Bands

OPTIONAL HOP-UP ITEMS:

FOLDING PROP - A folding prop can be used instead of the 8 x 4 nylon prop supplied. It will fold back against the fuselage when the motor is not running and enhance the soaring performance of the plane. Sonictronics makes several nice folding props and we have found the model #174 8 x 4 folding prop to work well on the SPECTRA with the GOLDFIRE motor. The spinner may have to be carved out slightly to clear a folding prop. Because the prop may have a tendency to keep spinning after the motor is shut off, the switch/motor should probably be re-wired to provide dynamic braking to the motor. This is easy to do and will make the motor stop turning so the prop will fold back. There is a sketch on page 35 showing this wiring modification.

LIGHTWEIGHT RADIO - There are several "Micro Systems" on the market that come with smaller servos, receiver and batteries. Futaba makes a radio especially for electric (model 4NBL Attack E) which works well with the SPECTRA. It comes with two S-133 Micro Servos and a 4 channel Receiver with a fully proportional electronic speed control built in. This unit also has BEC (Battery Eliminator Circuitry). This feature allows the radio system to be powered by the flight battery (6 or 7 cell). It will automatically shut the motor off before the battery is totally drained, leaving another 20 minutes or so of flying time in the flight battery. These smaller radio systems can save several ounces of valuable weight which will improve both the climbing and soaring capabilities of the plane.

COBALT MOTORS - A GOLDFIRE motor is included in this kit. It is a 550 size motor designed especially for airplanes. It is an inexpensive motor that is as powerful as many motors costing 3 times as much. We do not recommend that you use any of the 540 size "Car" motors. Their smaller size and higher RPM requirements do not work well when trying to turn a propeller at 12,000 rpm. If you want a higher performance motor, we recommend you use an Astro Fight .05 Cobalt Motor (Model 6605 or 6605 S). These motors are very powerful and will make your SPECTRA climb like crazy with some sacrifice in run time. We recommend that you use either Sermos Power Pole Connectors or Deans Connectors on the battery and motor when using high performance motors. These connectors have a very low resistance and will carry the larger currents better than the more popular connectors provided.

Your local hobby shop can be very helpful when deciding what types of accessories to purchase. We highly recommend that you consult with and support your local hobby dealer when purchasing the above items. He can also be a tremendous help if you have problems building or flying your models.

SUPPLIES AND TOOLS NEEDED

1 oz. Thin CA Adhesive
2 oz. Medium or Thick CA Adhesive (We'll refer to it as "thick" in the instructions)
2.5 oz. 30-Minute Epoxy
Hand or Electric Drill
Drill Bits: 1/16", 3/32", 1/8", 1/4"
Sealing Iron
Heat Gun
Razor Saw
Hobby Knife, #11 Blades
Pliers
Screw Drivers
T-Pins
Assorted Rubber Bands
Straightedge
Masking Tape
Sandpaper (coarse, medium, fine grit)*
T-Bar Sanding Block (or similar)
Waxed Paper
Lightweight Balsa Filler
Dremel Moto Tool or Similar (optional)

*NOTE: On our workbench, we have four 11" T-Bar sanders, equipped with #50, #80, #100 and #150-grit sandpaper. This setup is all that is required for almost any sanding task. We also keep some #320-grit wet-or-dry sandpaper handy for finish sanding by hand before covering.

A WORD ABOUT ADHESIVES

If you looked at the "ITEMS NEEDED" list above, you probably noticed that we recommend only two basic types of glue for assembling the SPECTRA. . .CA adhesives and Epoxy adhesive. Glues have come a long way in the past few years and these two types of adhesive are all that is needed to build a strong and light structure.

CA (Cyanoacrylate) - These are the "Super Glues". They have revolutionized model building by eliminating the "wait for the glue to dry" phase of building. CA'S will be used for 95% of the building. They come in several viscosities but we will only require the "Thin" (Runs like water) and the "Medium" (Like a thin syrup). The thin CA will be used where there is a nice tight fitting joint. It is applied after the

parts are in position and it seeps into the joint through capillary action and bonds the parts within a couple of seconds. The thicker CA is applied to the parts before they are joined and it takes up to 30 seconds to cure giving you a few seconds to position the parts. A related and very handy product is CA Accelerator Spray (Zip Kicker, etc.). This is used to instantly cure CA glues of all types.

EPOXY - Epoxy adhesives are two-part resins that are very strong but need to be mixed before they will cure. This process along with their heavier weight does not lend itself well to general construction. Epoxies are used where the utmost in strength is required. They come in many different cure times but we will only need 30 minute epoxy.

AN IMPORTANT TIP - Glue should never be substituted for a good-fitting joint. Take a little extra time to get a good joint and glue it properly and it will be much stronger, much neater and much lighter than a bad joint held together with a glob of glue!

COMMON ABBREVIATIONS USED IN THIS BOOK AND ON THE PLANS:

Elev	=	Elevator
Fuse	=	Fuselage
LE	=	Leading Edge (front)
Lt	=	Left
Ply	=	Plywood
Rt	=	Right
Stab	=	Stabilizer
TE	=	Trailing Edge (rear)
Tri	=	Triangle
"	=	Inches

TYPES OF WOOD

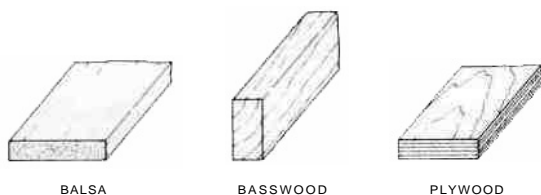

GET READY TO BUILD

NOTE: It will be helpful to build on a piece of "Celotex" (available from a lumber co.) or other semi-soft (and flat) surface, into which you may easily suck pins to firmly hold down the parts while building, and to avoid warps.

1. Unroll the plan sheet. Re-roll the plan inside out and let it uncurl while you read through this instruction book. This will help the plan lay flat and give you time to get acquainted with the building process. **NOTE: Because there are several options to consider when building the SPECTRA, you should read the instruction book through before building and then go back and cross off the steps you won't use to build your model.**

2. Remove all parts from the box. As you do, figure out the name of each part by comparing it with the plans, the die patterns (p. 3) and the parts list at the back of this book. Write the part **name** or **size** on each piece to avoid confusion later. If any of the die-cut parts are difficult to punch out during construction, do not force them! Instead, first cut around the parts with a hobby knife. After punching out the die-cut parts, use your T-Bar or sanding block to **lightly** sand the edges to remove any die-cutting irregularities.

NOTICE: INSTRUCTIONS IN BOXES ARE VERY IMPORTANT AND SHOULD BE FOLLOWED CAREFULLY.

"TAIL FEATHERS"

BUILD THE FIN AND RUDDER

You'll need the following parts:

SPRTS02	3/16" x 3/8" x 30" Balsa Stick
SPRTS03	1/8" x 3/16" x 30" Balsa Stick
SPRTS01	3/16" Die-Cut Balsa Tail Parts
SPECF08	3/16" Balsa Triangle

D 1. Tape or pin the **plan** down to your flat work surface. Tape a piece of waxed paper over the fin and rudder portion of the plan (so you don't glue the parts to the plan).

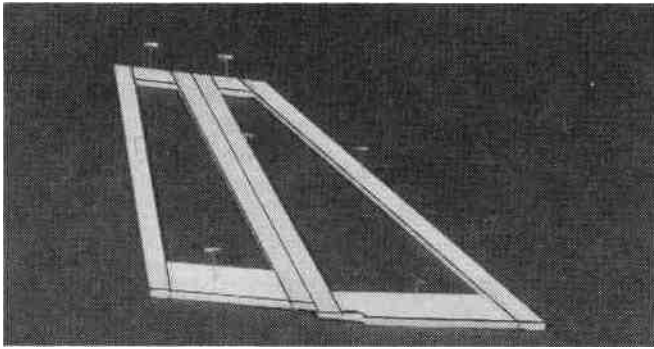

D 2. Using the plan as a guide, cut pieces of 3/16" x 3/8" balsa (from the 30" sticks, SPRTS02) to make the **Rudder and Fin Framework**. NOTE: Cut the Fin L.E, the Rudder L.E. and the Rudder T.E. from a single SPRTS02 (this will leave enough long pieces for the stab frame). Punch out the die-cut **Fin Tip, Rudder Tip, Fin Base and Rudder Base** from SPRTS01. Sand any rough edges on these pieces and then pin them in place on the plan. Glue the parts together using thin CA glue. **CAUTION: Do not glue the fin to the rudder!**

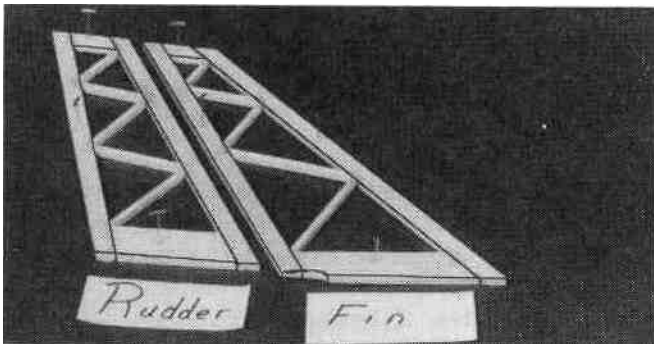

D 3. From the 1/8" x 3/16" x 30" sticks (SPRTS03), cut the diagonal "**ribs**" to fit between the rudder and fin framework, and glue them in place. NOTE: It is **not** necessary to get these ribs in the **exact** position shown on the plan.

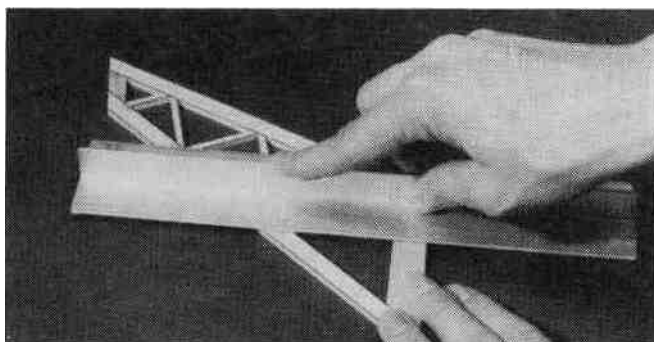

D 4. Remove the fin and rudder assemblies from the plan and examine them for any open or bad joints. Fill any gaps with thick CA, then use your sanding block with medium grit sandpaper to sand both sides of the framework smooth.

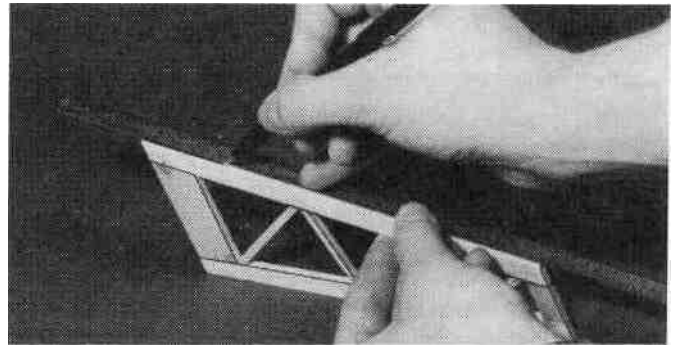

D 5. Carefully draw a **centerline** all around the edges of the rudder (this will help to maintain symmetry when sanding).

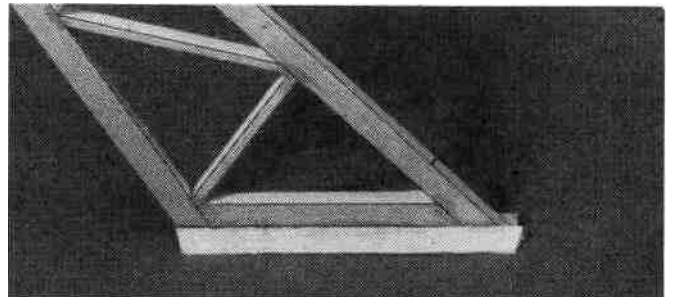

D 6. Cut 4-1/8" off of the 3/16" **Balsa Triangle** (SPECF08) and glue them along the bottom of the fin. The bottom edges of the triangle should be flush with the bottom of the fin.

D 7. Using a sanding block and **coarse** (50 or 80-grit) sandpaper, sand the leading edge of the rudder to the V-shape as shown on the plans (a small razor plane works great for initial shaping). Sand the three remaining edges to a smooth rounded shape. Sand the top and the leading edge of the fin to a nice rounded shape*. NOTE: **The trailing edge of the FIN must remain square, do not round it!** Sand the triangle stock to blend with the leading and trailing edges of the fin. Also, cut or sand the **bottom** of the triangle stock to match the contour of the 3/16" die-cut fin bottom.

* **MAXIMUM PERFORMANCE TIP** - Sand both sides of the rudder to a taper as shown on the plans. This requires a little more work but will help to reduce drag and thus increase performance of the sailplane.

BUILD THE STABILIZER AND ELEVATOR

You'll need the following parts:

SPRTS02	3/16" x 3/8" x 30" Balsa Sticks
SPRTS03	1/8" x 3/16" x 30" Balsa Slicks
SPRTS01	3/16" Die-Cut Tail Parts
SPRTS04	Tapered Elevator

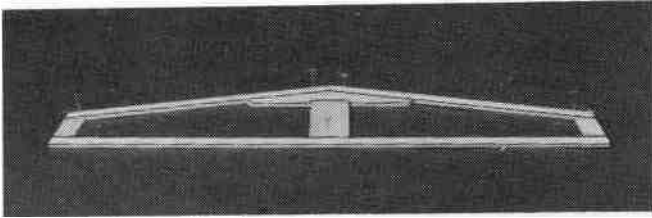

D 1. Tape waxed paper over the **stabilizer** drawing on the plan so you don't glue the parts to the plan. Using the plan as a guide, cut the 3/16" x 3/8" balsa pieces from SPRTS02. Punch out the die-cut **Stab Tips, Stab Center and Stab Brace** from SPRTS01 and sand the edges if necessary to remove any "fuzz". Assemble the stab framework by pinning everything in place on the plan. Glue the parts together using thin CA glue.

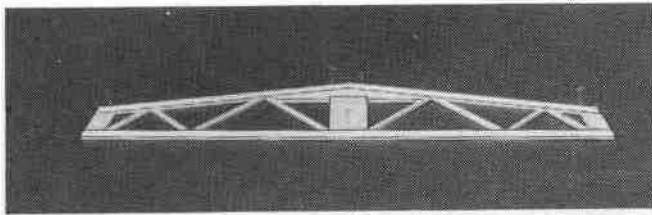

D 2. Cut and sand the 1/8" x 3/16" "**ribs**" (from SPRTS03) to length and glue them in place. NOTE: It is not necessary to get these ribs in the exact position shown on the plan.

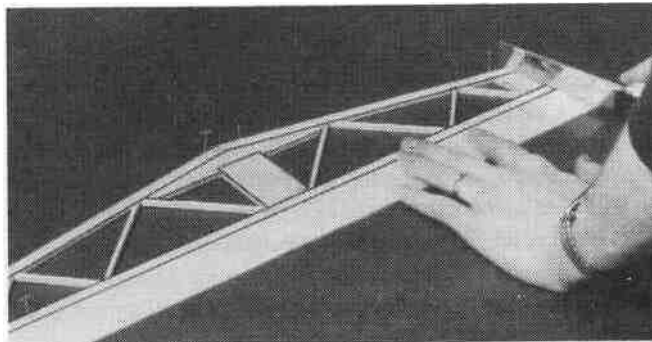

D 3. Pin or tape the **elevator** (SPRTS04) in place behind the stab and use your razor saw to cut the ends off to match the stab. Sand the the two front comers of the stab to round them off.

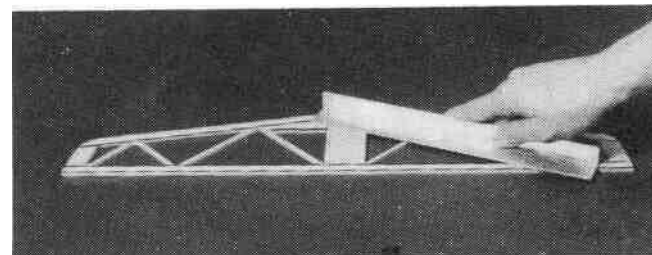

D 4. Remove the stab from the plan and examine it for any open or bad joints. Fill any gaps with thick CA, then use your sanding block with medium grit sandpaper to sand both sides smooth. Carefully draw a centerline around the edges of the stab (this will help maintain symmetry when sanding).

D 5. Tape the elevator to the stab using masking tape and sand the leading edge of the stab, the stab tips and the elevator tips to a smooth rounded shape. The tips of the elevator should blend in nicely with the stab tips.

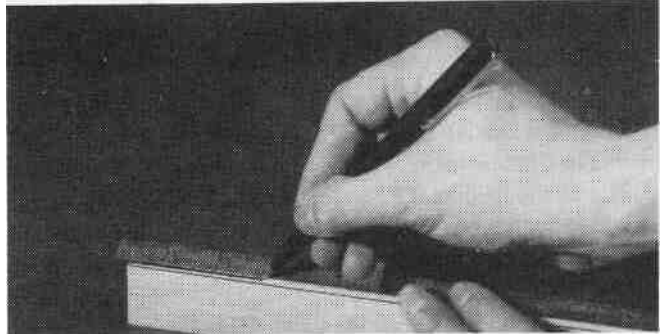

D 6. Remove the elevator and draw a center line down its leading edge. Use your sanding block to sand the same V-shape as you did on the rudder. The trailing edge should also be sanded to a smooth rounded shape. Apply thin CA the the tips of the elevator to harden the wood, and help protect it from damage.

CUT THE HINGE SLOTS (Do not glue)

NOTE: One-piece molded polypropylene hinges are supplied in this kit. We have tested many different hinges and have found that these hinges are one of the best available. We recommend that you use these hinges and follow the instructions below to install them. If you choose to use these hinges or the "pinned"-type hinges, you should cut the hinge slots at this time. However, if you choose to use the one-piece hinges that are paper covered for CA glue installation, you may wait until after covering before cutting the hinge slots.

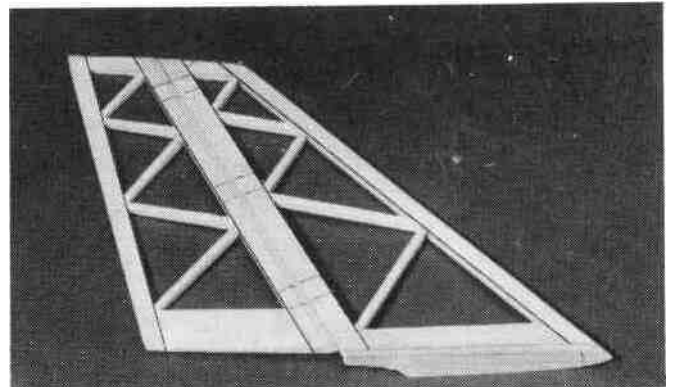

D 1. Lay the rudder and elevators on the plan and mark the **hinge locations**. Place the rudder against the fin TE and transfer the marks over to the fin. Place the elevator against the stab TE and transfer the marks over to the stab.

CAUTION!!!: You must use extreme care when cutting hinge slots with a hobby knife, to avoid cutting yourself! If the balsa part breaks while you are pushing on the knife, the blade could go into your hand before you know it! A good precaution is to wear leather gloves while performing the following steps.

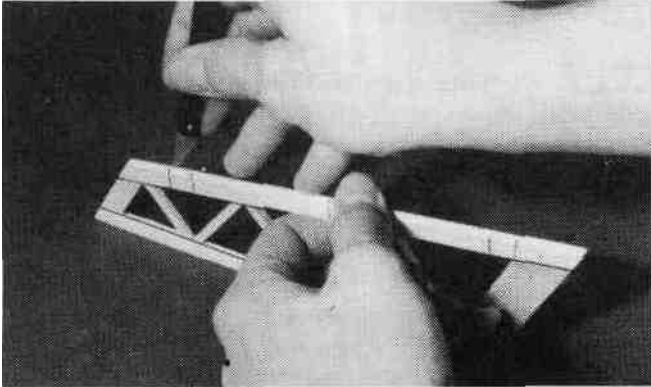
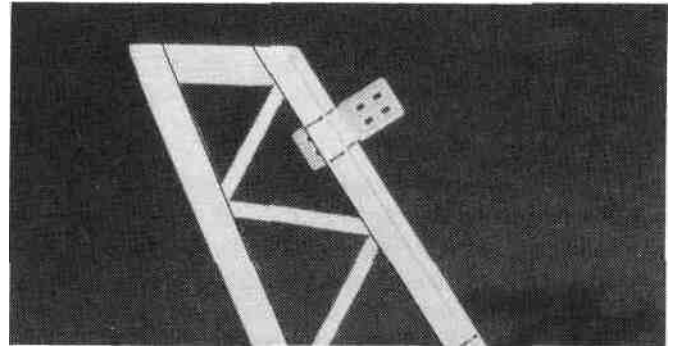

D 2. Draw accurate centerlines down the trailing edge of the stab and the fin. Cut the hinge slots **on these lines** using a hobby knife or a slotting fork and slotting hook. (The recommended hinge slotting technique is listed below).

A. Begin by carefully cutting a **very shallow slit** at the hinge location. This first cut is to establish your cut in the right place, so concentrate on staying on the centerline and **don't cut too deep!**

B. Make three or four more cuts in the same line, going slightly deeper each time. As you make these additional cuts, work on going straight into the wood. Continue this process while "wiggling" the knife handle forward and backward until the blade has reached the proper depth for the hinge.

C. Trial fit the hinge into the slot. If the hinge is difficult to push in, re-insert the knife and move it back and forth in the slot a few times to enlarge the slot.

D 3. **IMPORTANT! Condition or "break-in" the hinges by folding them back and forth several times.**

D 4. Insert the hinges into the slots and trial fit the rudder and elevator in place on the fin and stab. **Do not glue the hinges until after you have covered the model.** The photo for this step is at the top of the next column.

WING ASSEMBLY

A DECISION YOU SHOULD MAKE NOW... "WING CONFIGURATION"

The SPECTRA kit has two different wing options: a two-piece wing or a one-piece wing. The two-piece wing is the standard way to build the wing and it is much easier to transport. The instructions also explain how to build the wing in one piece which makes it a little stronger but makes it harder to transport in today's small cars.

BUILD THE INNER WING PANELS

You'll need the following parts:

SPRTW01	1/8" Die-Cut Balsa Wing Ribs
SPRTW02	1/16" Die-Cut Balsa Wing Ribs, W2, W2S
SPRTW03	1/16" Die-Cut Balsa Wing Ribs, W2, W4-W10
SPRTW04	1/8" Die-Cut Plywood Dihedral Braces
SPRTW07	1/16" Die-Cut Balsa Shear Webs
SPRTW08	1/8" Die-Cut Plywood Clamps and Gauges
SPRTW10	Shaped Balsa Leading Edge
SPRTW11	Shaped, Notched Balsa Inner Trailing Edge
SPRTW13	1/8" x 5/16" x 23-1/2" Basswood Spars
SPRTW17	1/16" x 3" x 24" Balsa Wing Sheeting

NOTE: The wing is designed to be built as a two-piece wing; however, we also describe how to build a one-piece wing.

D 1. Tape the plan to your flat work surface, and cover the wing drawing with waxed paper. **NOTE:** If your work space is limited, you may cut the wing drawings apart from the rest of the plans.

D 2. **The Shaped Wing Leading Edges (SPRTW10)** are fastened together by thin strips of balsa. Separate them by carefully cutting **between** the LE'S. Sand away the excess balsa that remains along the edges after cutting them apart, using a sanding block with 100-grit sandpaper. Be careful when cutting and sanding to follow the contour of the LE'S and **don't sand any more than necessary**, otherwise they may not match up with the ribs and sheeting.

D 3. Before using the **1/8" x 5/16" x 23-1/2" Basswood Spars (SPRTW13)**, examine them carefully for possible imperfections. Look for knots, soft spots, diagonal grain and any other imperfections. If possible, position each spar so the imperfections are on the outer half of the wing panel (toward the tip), where they will be least affected by high stress. If the spars are warped slightly, "balance them out" by installing the warped spars in opposite directions (see sketch).

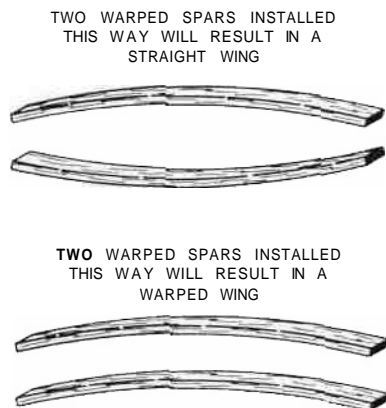

D 4. Carefully punch out all the die-cut **1/16" Balsa W2 and W2S Wing Ribs**. Sand the edges **slightly** to remove any die-cutting irregularities. The W2S ribs have a die-cut notch to clear the spoilers in the **SPIRIT** kit and are not used in this kit so just treat them like a W2 rib and **do not punch out the notch**.

NOTE: Begin building the LEFT wing panel, starting at step 5 on page 10. Continue through step 8 on page 15. Next, repeat these steps to build the right wing panel.

DD 5. Pin one of the notched balsa **Inner Trailing Edges (SPRTW 11)** to the plan lining up the notches in the TE with the notches on the plan. Notice that the notches near W3 are only 1/16" wide since half of the 1/8" wide rib notch is in the inner T.E. and the other half is in the outer T.E..

DD 6. Place one of the **1/8" x 5/16" x 23-1/2" Basswood Inner Spars (SPRTW13)** on the wing plan and pin the spar down with crossed T-pins as shown in the following sketch.

NOTE: The spars may be cut slightly too long. The excess will be cut off later.

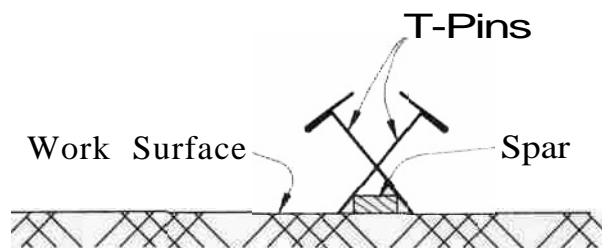

DD 7. Place the seven **W-2 ribs (from SPRTW02 and SPRTW03)** and the two **W-2S ribs (from SPRTW02)** on the spar in their approximate positions, work the ribs into the notches on the trailing edge but do not glue anything yet.

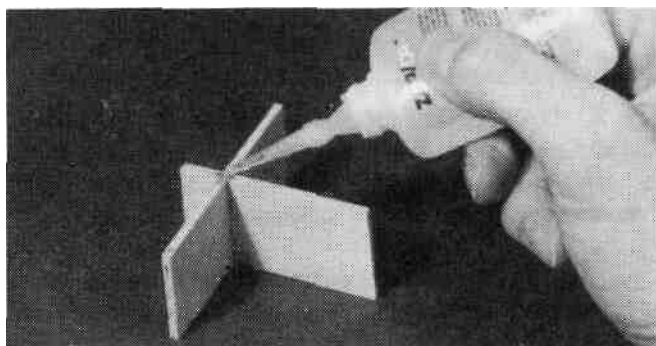

DD 8. Punch out the two **Rib Gauge Pieces** from the 1/8" die-cut plywood sheet (SPRTW08) and assemble them using CA. Notice that one end of the gauge is slanted at a 5 degree angle for positioning the end ribs. The other 3 ends are perpendicular and can be used to keep parts 90 degrees to the work surface.

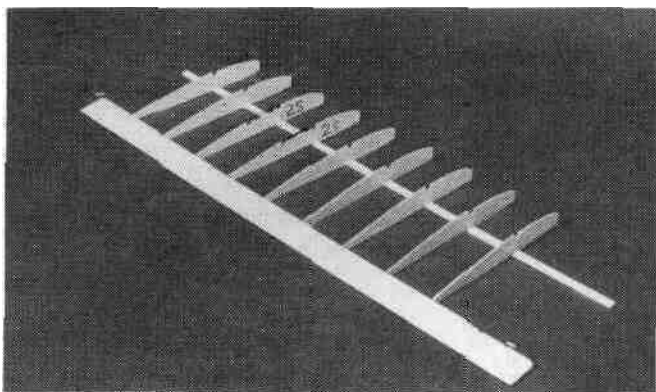

DD 9. Make sure the ribs are properly positioned according to the plans and glue them in place using thick CA at the spar joint and a drop of thin CA at the trailing edge joint. Use

the square end of the rib gauge to keep the ribs perpendicular to the work surface.

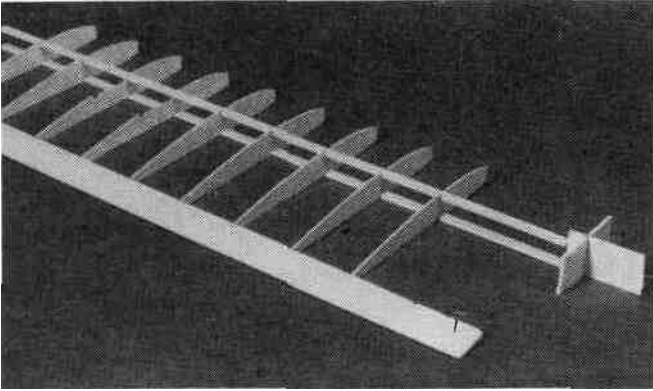

DD 10. Trial fit the top 1/8" x 5/16" x 23-1/2" Basswood Inner Spar (SPRTW13) into the notches in the ribs by carefully pushing the spar completely down into the notches. Make sure the top spar is lined up lengthwise with the bottom spar. Remove the spar and glue it in place by applying thick CA to the notches before the spar is put back in place.

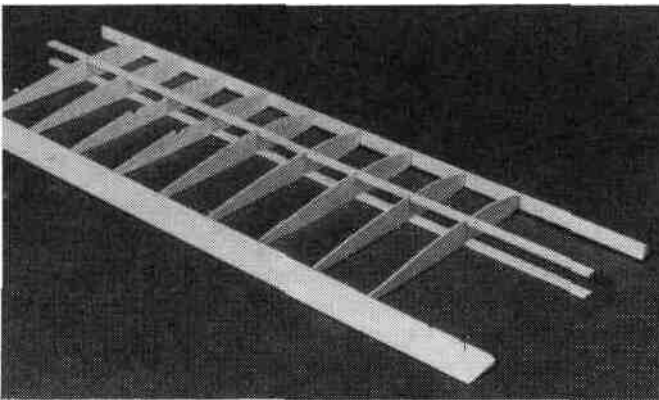

DD 11. Position a Pre-shaped Leading Edge (SPRTW 10) in place over the plans. **NOTE: These leading edges are NOT symmetrical.** Refer to the wing end view on the plan to determine which way they should be installed. Carefully hold the leading edge against one of the end W-2 ribs and note that it is wider than the front of the rib. This is because the 1/16" balsa leading edge top sheeting will be added later. Align the lower surface of the leading edge with the bottom of the rib and glue it in place with a drop of thin CA (there must be a 1/16" gap between the top of the rib and the top of the LE so the sheeting will fit). Lift up the other end of the leading edge, align it with the bottom of the opposite end W-2 and glue it with a drop of thin CA. Go down the line and glue the remaining ribs to the leading edge one at a time so you can make sure they are aligned. CA Accelerator may come in handy for speeding up this process if you don't want to hold the LE in place long enough for the glue to cure naturally.

DD 12. Locate the 1/16" Balsa Die-Cut Shear Web Sheet (SPRTW07) and notice that all of the shear webs are not the same. The webs between the stamped number 2's are for use on the inner panel. The webs between the 2 and the 10 are for the outer panel and each one of these is a different size so keep them in the sheet until they are ready to be used. **Punch out all of the "2" shear webs.**

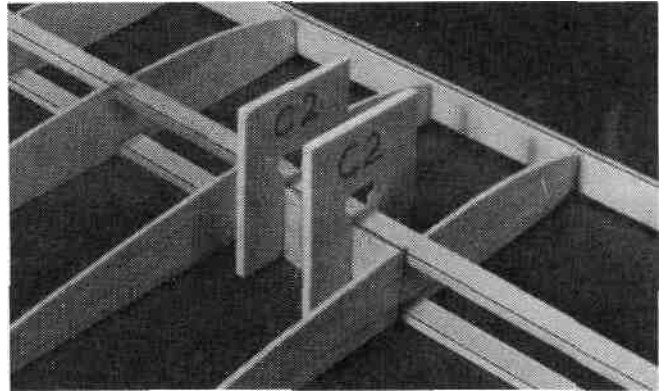

DD 13. Trial fit one of the webs in place between the first two W-2 ribs. You may have to sand it slightly to get it to fit. Glue the shear web in place on the **back** of the spars using thick CA. The webs should be centered between the spars. It is important to do a good job of gluing these in place as they are responsible for most of the wing's strength. **C-2 Clamps** from the 1/8" Die-Cut Plywood Sheet (SPRTW08) can be used to help hold the webs in place while the glue cures.

DD 14. Install the remaining balsa shear webs. Note that the webs are only installed between the ribs already glued in place. Three webs are also installed on the **front** of the spars in the first three rib "bays". Remove the T-Pins as the webs are installed but make sure the panel is kept flat throughout this process.

IF YOU ARE BUILDING A ONE-PIECE WING, SKIP AHEAD TO "BUILD THE OUTER WING PANELS" ON PAGE 13. STEPS 15 THROUGH 23 ARE FOR A 2-PIECE WING ONLY.

DD 15. Locate the 1/8" die-cut sheet (SPRTW04) that contains the **Dihedral Braces**, the **Leading Edge Brace** and the **Wing Joiner Lamination**. Line a ruler up with the two embossed cut marks and draw a line across both of the dihedral braces.

DD 16. Punch out the two dihedral braces and cut them in half with a razor saw along the lines you just drew. **Note: these braces are supplied in one-piece for the one piece option.** Also punch out the wing joiner lamination from that

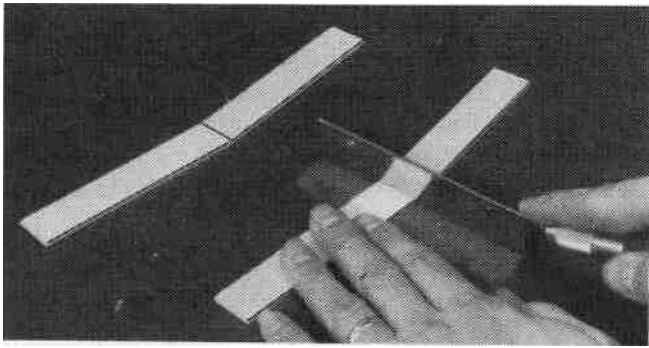

sheet and set it aside for the next step. The leading edge brace is not used in a two-piece wing.

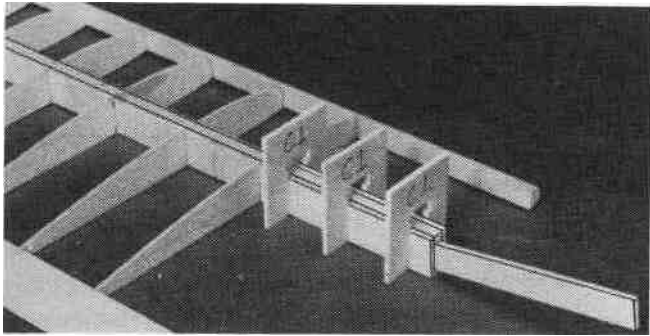

DD 17. Punch out the three **C1 clamps** from the 1/8" die-cut plywood sheet (SPRTW08). Test fit two of the dihedral brace "halves" to the "root" (inner) end of the inner panel spars. One brace should be installed on the front of the spars and the other on the back. The edge that you cut with the razor saw should be near the end of the spars and it should be placed so that it slants in at the top (short edge at top). Use the C1 clamps to hold the braces in place and test fit the wing joiner lamination into the box formed. This "box" will be referred to as the "joiner box". The wing joiner lamination is used to make sure the spars remain the correct distance apart.

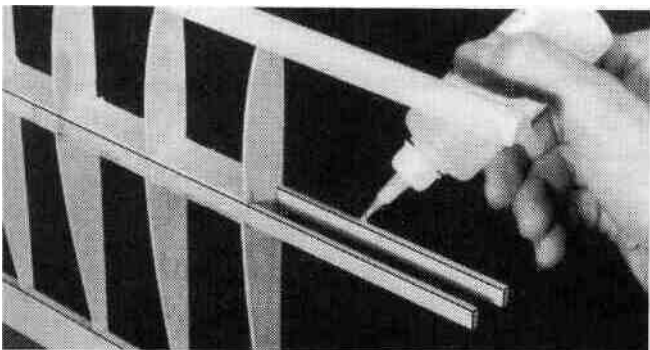

DD 18. Remove the clamps and apply a bead of epoxy or thick CA along the spar edges. Install the braces and hold in place with the C1 clamps. A good glue joint is important here

but be careful not to get any excess glue inside the box formed by these braces, or the wing joiner will not fit inside. Also test the size of the joiner box with the joiner lamination while the glue is curing. Be careful: don't glue the joiner lamination.

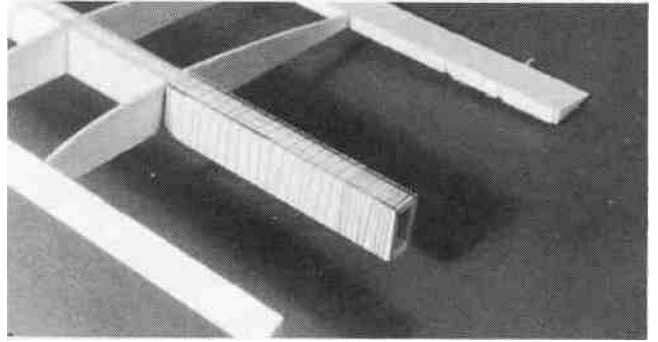

DD 19. Tightly wrap the joiner box with a strong **thin** thread and then soak it with thin C/A. This will add a lot of strength to the joiner box. Do not overlap the thread or allow it to build up too thick.

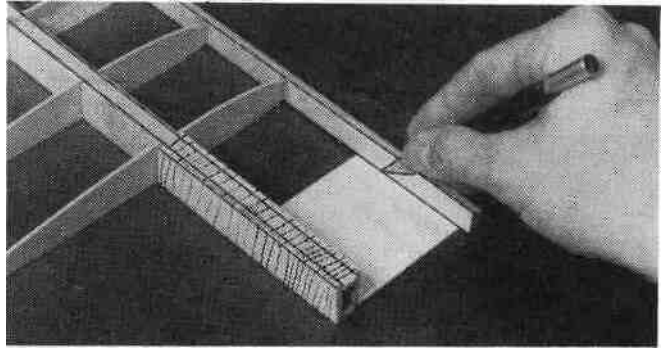

DD 20. Locate one of the **1/16" x 3" x 24" Balsa Sheets** (SPRTW17) and cut it into 8 pieces 2-3/8" long. Slide one of the sheets in place in front of the joiner box and trim to fit as shown in the photo. Use another piece of sheeting to shim the front edge up against the bottom of the ribs as shown in the following sketch. Glue it in place, 1/16" Balsa

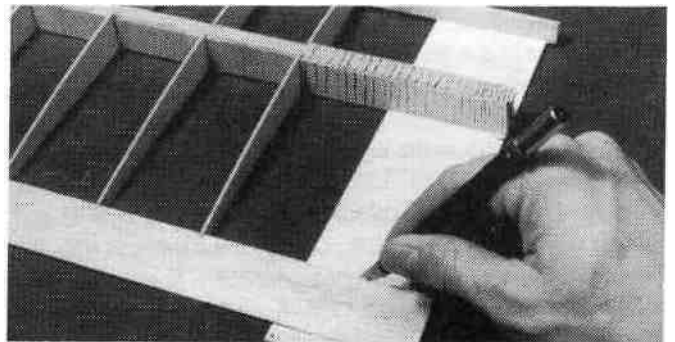
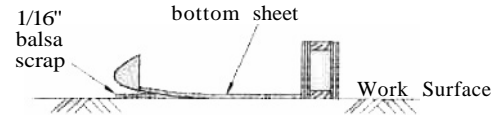

DD 21. Glue another piece to the rear of the joiner box and then cut a third piece to fit behind the second and glue it in place.

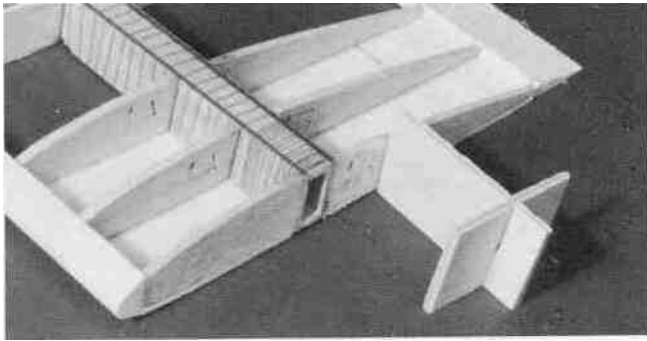

DD 22. Punch out three **W1A** ribs and three **W1B** ribs from the 1/8" die-cut balsa rib sheet (SPRTW01). Test fit these ribs into position. A little sanding may be necessary to make them fit properly. Glue these ribs into place using thick CA. The end rib should be tilted in at the top using the slanted end of the rib gauge to give it the correct angle.

DD 23. Cut and sand the leading edges, trailing edges and spars to their correct length.

BUILD THE OUTER WING PANEL

You'll need the following parts:

- SPRTW03 1/16" Die-Cut Balsa Wing Ribs W4 - W10
- SPRTW07 1/16" Die-Cut Balsa Shear Webs
- SPRTW10 Shaped Balsa Leading Edge
- SPRTW12 Shaped, Notched Balsa Outer Trailing Edge
- SPRTW14 1/8" x 5/16" x 15-1/8" Basswood Outer Spars
- SPRTW15 7/8" Shaped Balsa Wing Tip Block

DD 1. Lay one of the Outer Trailing Edges (SPRTW12) in place over the plan. Align the notches in the trailing edge with the notches on the plans and pin it in position. **NOTE: The un-notched end of this trailing edge is not used and goes out toward the tip of the panel.** Cut the extra trailing edge off 1/4" past the last notch.

DD 2. "Cross pin" one of the 1/8" x 5/16" x 15-1/8" Basswood Outer Spars (SPRTW14) in place.

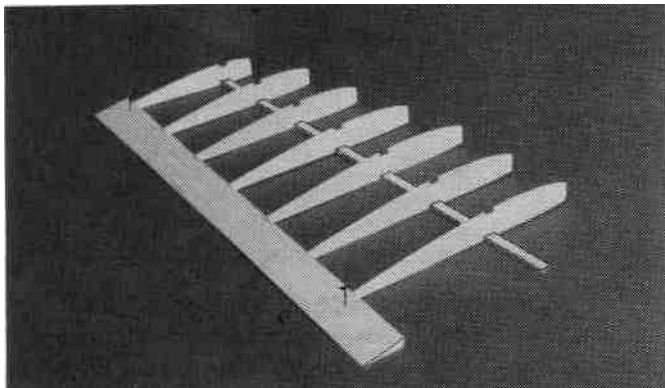

DD 3. Punch out the 1/16" (W4-W10) Tip Ribs out of one of the SPRTW03 die-cut sheets. Glue the ribs in place

with a thick CA at the spar joint and a drop of thin CA at the trailing edge joint. Use the rib gauge to keep the ribs perpendicular.

DD 4. Trial fit the top 1/8" x 5/16" x 15-1/8" Basswood Outer Spar in place by carefully pressing the spar into the notches until it is flush with the top of the ribs. Remove the spar and apply thick CA to the notches. Replace the spar and allow the glue to cure.

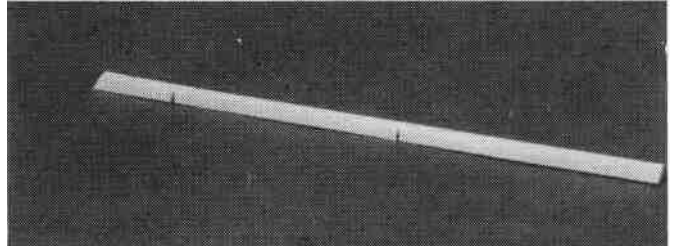

DD 5. Lay one of the remaining **Pre-Shaped Leading Edges** over the LEADING EDGE TEMPLATE at the top right corner of the plans. Use this drawing as a reference to cut the leading edge to length and to cut the relief notches. **It is a good idea to cut the leading edge approximately 1/4" longer on both ends to be on the safe side.** It can be cut to the correct length after it is installed. The relief notches do not need to go all the way through the leading edge but should go within 1/8" of doing so. **NOTE: you need to make a "right" and a "left" LE.**

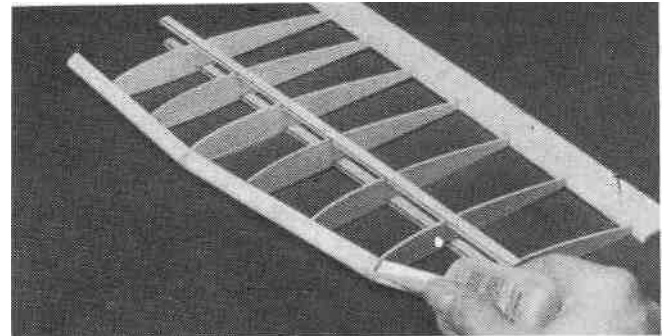

DD 6. Carefully bend the leading edge to the angle shown on the plans and position it against the ribs. The bends should be at ribs W6 and W9. Align the leading edge with the ribs and glue it in place just as you did for the inner panel except **start at ribs W6 and W9**. Also note that there is no sheeting on the outer panel so the ribs are the full height of the LE.

DD 7. Punch out the remaining 6 shear webs (from SPRTW07) and lay them end to end so that the end of one web is the same size as the end of the one next to it as shown in the sketch below. This is the order and direction they will be installed in the wing. The shortest web goes between ribs W9 & W10 and the longest web goes between ribs W4 & W5. **NOTE: These webs are actually tapered to match the taper of the wing.** There is a sketch at the top of the next page to illustrate this taper.

NOTE TAPER OF WEBS

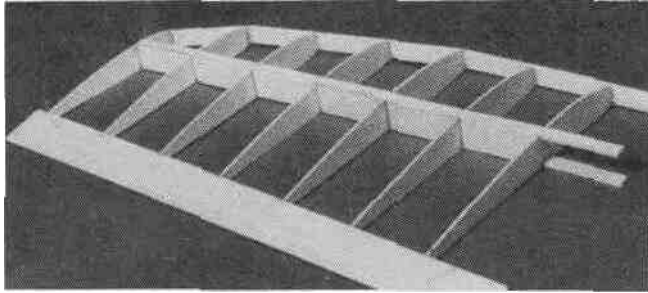
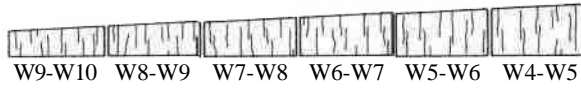

DD 8. Glue the webs into their respective places using thick CA. The thinnest end of each web goes towards the tip of the panel.

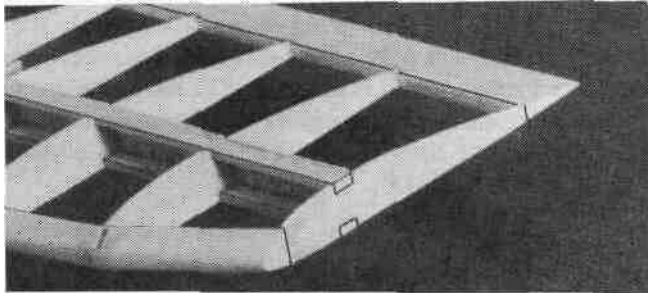

DD 9. Cut and sand the trailing edge, spars and leading edge flush with rib W10.

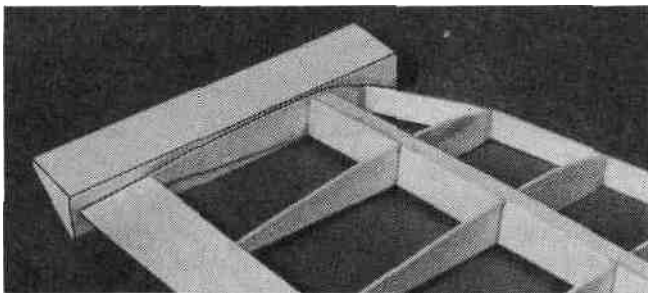

DD 10. Glue the 7/8" x 1-3/16" x 6-1/4" **Triangle Wing Tip Blocks** (SPRTW15) to W10 with thick CA. The sketch below and the cross sections on the plan shows how the block should be attached to get the correct tip shape.

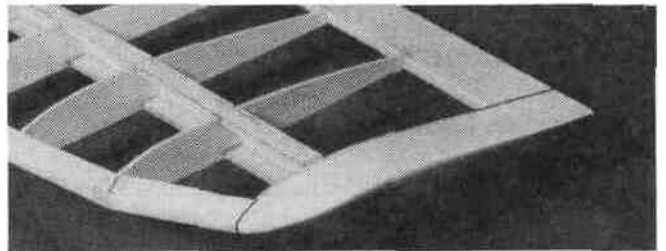
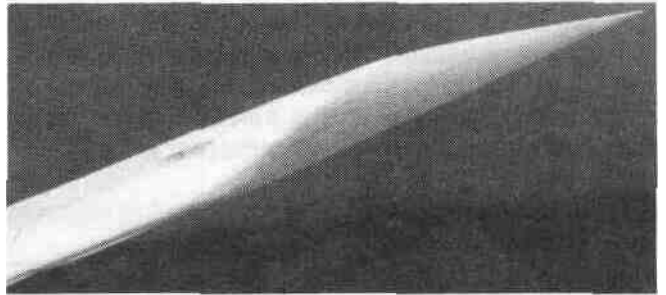
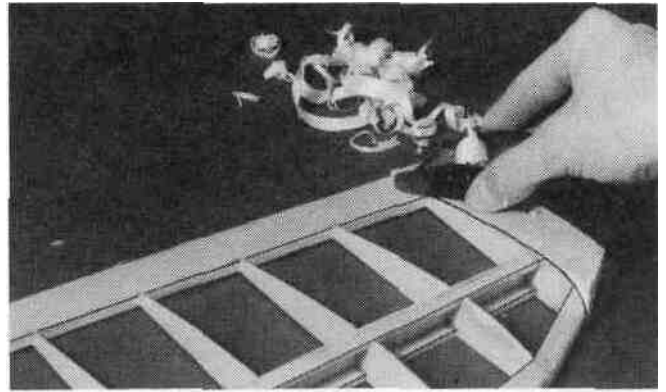
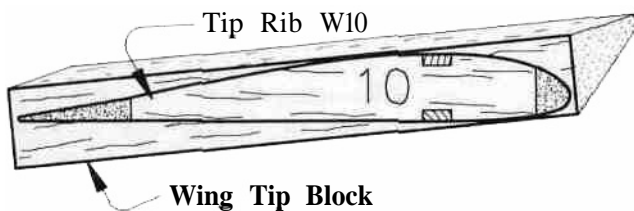

DD 11. Carve and sand the wing tip to blend with rib W10. Be careful not to change the shape of W10 while sanding the tip. There are three section views on the left wing plan and three photos above to help show you the desired shape. Do not sand the trailing edge of the tip too thin or it will get damaged easily; 1/16" thick is fine.

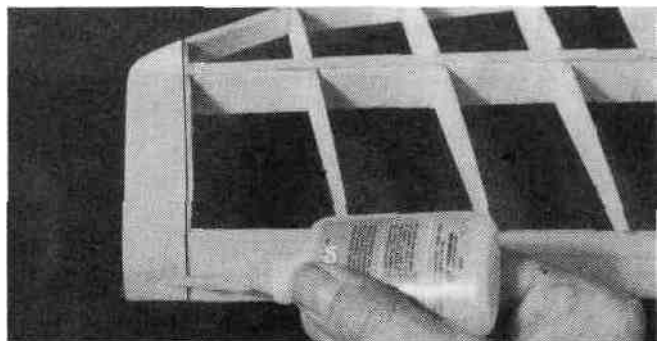

DD 12. Apply several drops of thin CA to the rear portion of the balsa wing tip. Allow the glue to soak into the wood and cure. The glue will help harden the wood and protect it from damage.

JOIN THE INNER AND OUTER WING PANELS

You'll need the following parts:

SPRTW06 1/32" Plywood Polyhedral Braces
SPRTW08 1/8" Plywood Clamps and Gauges

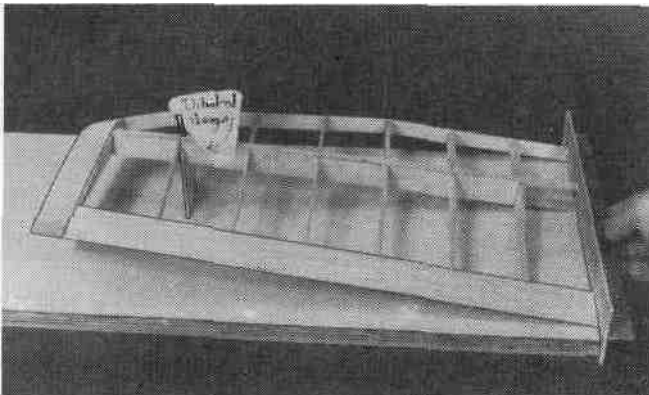

DD 1. Prop up the **outer panel** 2-5/8" (from the work surface to the bottom of W10) using the **lower notch** in the **Dihedral Gauge** (from SPRTW08) next to rib W9. **The** notches in the dihedral gauge are a tight fit so they will stay in place once positioned. Use a sanding block to carefully sand the leading edge, spars and trailing edge to achieve vertical surfaces on each as shown in the photo. Check your progress by occasionally setting the panel on the plans to make sure you are not sanding any "sweep" (forward or backward tilt) into the wing panel.

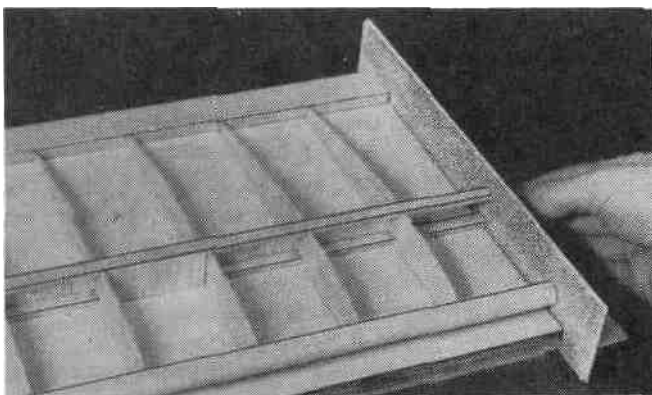

DD 2. With the **inner panel** flat on the work surface and your sanding block perpendicular to the work surface, sand the leading edge, spars and trailing edge (the outer end) so they are all even and of the correct length.

DD 3. Test fit the inner and outer panels together over the plan to make sure the leading edges, spars, and trailing edges all meet up nicely when the tip panel is blocked up the required 2-5/8" (at the bottom of rib W10) with the **lower notch** of the dihedral gauge. The plans show where the dihedral gauge should be placed (next to W9) to achieve the

correct angle. Sand any ends if needed to make everything fit well. The photo for this step is below.

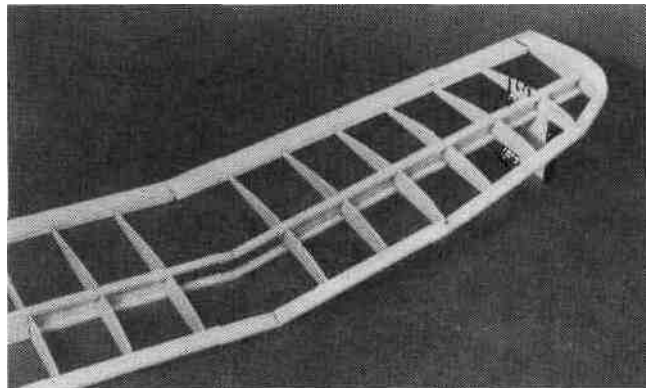

DD 4. With the dihedral gauge in place. Apply thick CA or epoxy to the leading edge, trailing edge and spar joints to "tack glue" the two panels together. Hold everything in place until the glue has cured.

DD 5. Punch out two of the 1/32" Plywood Polyhedral **Braces** from the die-cut sheet (SPRTW06) and test fit them in place against the front and back of the spars. Sand them if needed to achieve a good fit.

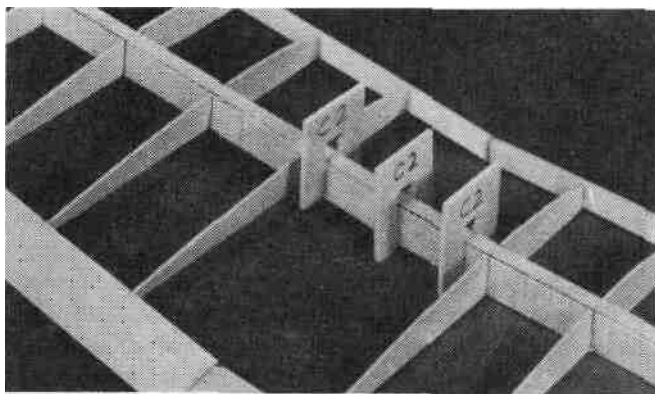

DD 6. When satisfied with the fit apply a generous bead of epoxy or thick CA to the spars and install the braces on both sides of the spars. Center the braces between the spars and use the die-cut C2 Clamps (from SPRTW08) to hold everything in place.

DD 7. Glue the 1/32" **Plywood Leading Edge Brace** (from SPRTW06) in place against the leading edges. Align the brace with the bottom of the leading edge to allow for the 1/16" balsa leading edge sheet which will be applied later.

DD 8. Install ribs W3A and W3B between the inner and

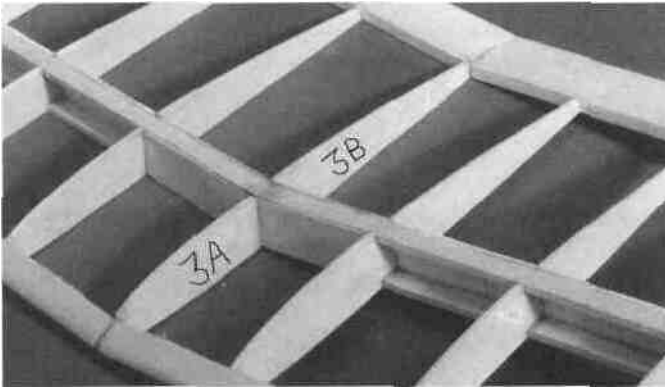

outer panels using thick CA as shown in the photo. A little sanding may be necessary to achieve a good fit.

D 9. Now go back to step 1 and assemble the other half of the wing.

FINAL WING ASSEMBLY

IF YOU ARE BUILDING A ONE-PIECE WING SKIP AHEAD TO STEP 4

You'll need the following parts:
 Aluminum wing joiner blade, 1/8" ply joiner and two 1/16" ply joiners.

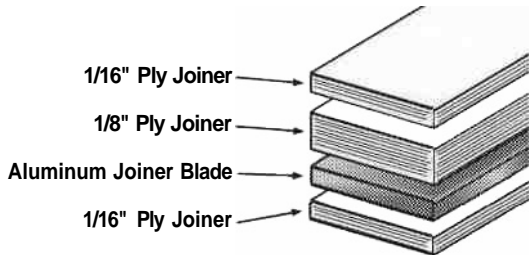

D 1. We have included a "high strength" aluminum wing joiner blade in this kit. If you are going to build your Spectra with a two piece wing, use the aluminum joiner blade, a 1/8" ply joiner and two 1/16" ply joiners as shown above. Sand the sides of the aluminum joiner with coarse grit sandpaper and then thoroughly clean it with rubbing alcohol before gluing in place. If you are building the one piece wing, the aluminum joiner is not necessary.

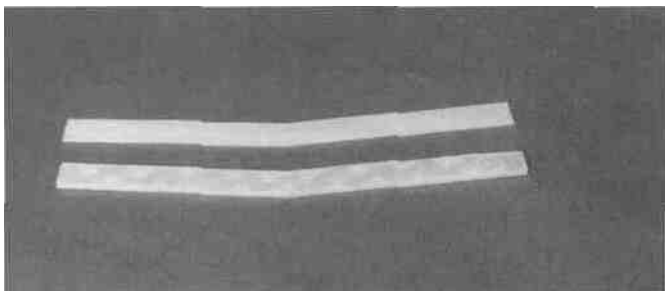

D 2. Use 30-minute epoxy to glue one of the 1/16" ply joiners

to the aluminum joiner blade. Glue the 1/8" ply joiner and the other 1/16" ply joiner to the aluminum joiner blade (refer to the sketch at step 1) using the same procedure. Apply as much pressure (clamps, clothespins, weights, etc.) as possible while the glue is curing and be sure to accurately line up the pieces.

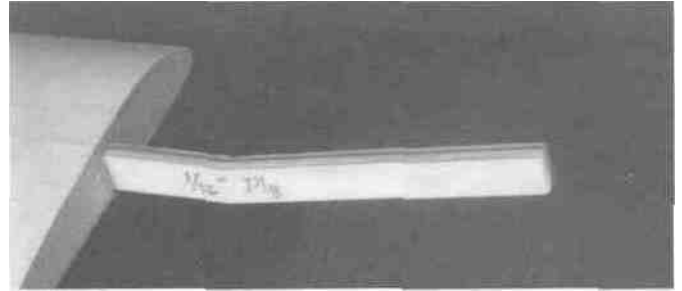

D 3. Sand the edges of the finished "wing joiner" to remove any glue globes and test fit it in the wing joiner box. Some sanding may be required to get a nice smooth **but not loose** fit. If the joiner is loose, thick CA or epoxy may be used to "build up" the joiner anywhere it may be needed to achieve a nice fit in the wing.

IF YOU ARE BUILDING THE TWO-PIECE WING SKIP AHEAD TO STEP 13

D 4. Prop up one wing half 2" (as measured from the work surface to the bottom of rib W3) and sand the root (Inner) end of the trailing edge, spars and leading edges to achieve vertical surfaces as you did earlier for the outer panels. Do the same for the other wing panel.

D 5. Test fit the two inner panels together by laying one panel flat on the work surface and using the dihedral gauge to prop up the other panel 4" (at the bottom of rib W3). Use the dihedral gauge next to the last W2 rib to achieve the correct angle. Make sure that each spar, etc. just touches the opposite spar, etc. of the other panel. Carefully sand the longest ends until a good joint is achieved between each member.

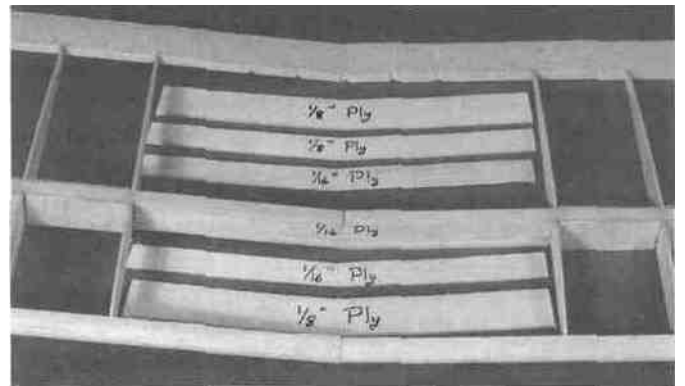

D 6. Punch out all four of the **Wing Joiner Laminations**,

the **Dihedral Braces** and the **Leading Edge Brace** from the die-cut sheets SPRTW04 and SPRTW05. Test fit all of the pieces in place and sand them if necessary to make them fit nicely. The wing joiner laminations are installed between the spars and are sandwiched in place by the dihedral braces. The C1 clamps can be used to hold everything in place.

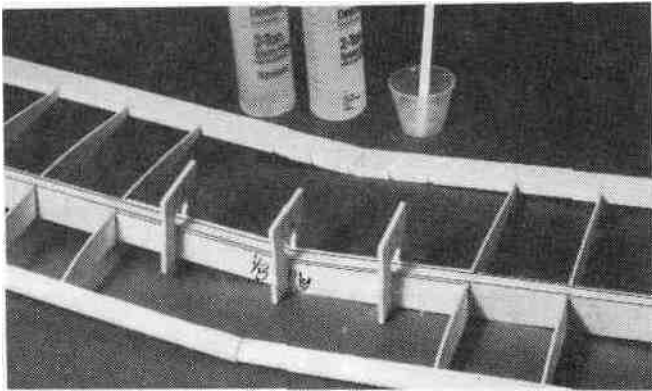

D 7. When satisfied with the fit, mix up a batch of epoxy (30 minute cure time is ideal, 5-minute is too fast), coat the joiner laminations with a layer of epoxy and install the joiner laminations between the spars. Quickly apply some epoxy to the dihedral braces and hold them in place using the C1 clamps. Also apply some glue to the leading and trailing edges and pin them together to keep them aligned with one another. Wipe off any excess epoxy that may have squeezed out before it cures. After the glue cures sand off any glue globs that may have formed.

D 8. It is not necessary to wrap the dihedral braces **with** thread when assembling a one-piece wing. Just disregard any references or photos showing the thread.

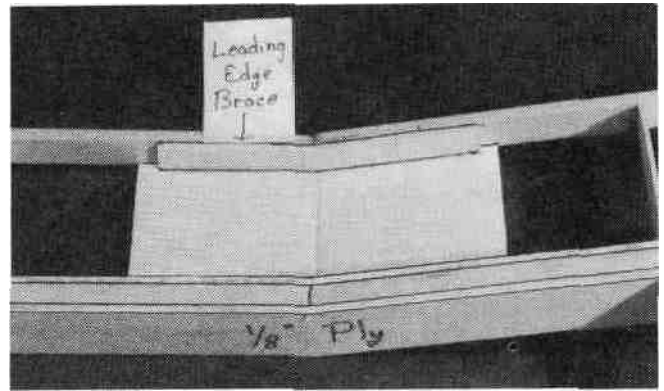

D 10. Locate one of the **1/16" x 3" x 24" Balsa Sheets** (SPRTW17) and cut it into 8 pieces 2-3/8" long. Slide one of the sheets in place in front of the dihedral brace, trim it to fit and glue it to the LE and the dihedral brace with thick CA. Press the sheeting in place to make it conform around the thread. A second piece of balsa can be used as a shim to hold the sheeting against the LE as shown in the sketch at step 20 on page 12.

D 11. Glue another piece of 1/16" sheeting to the rear of the dihedral brace, then cut a third piece to fit behind the second and glue it in place.

D 12. Punch out six W1A ribs and six W1B ribs from the 1/8" die-cut balsa rib sheet (SPRTW01). Test fit these ribs into position. A little sanding may be necessary to make them fit properly. Glue all six **W1A** ribs and all six **W1B** into place using thick CA (the two center W1B ribs are glued together).

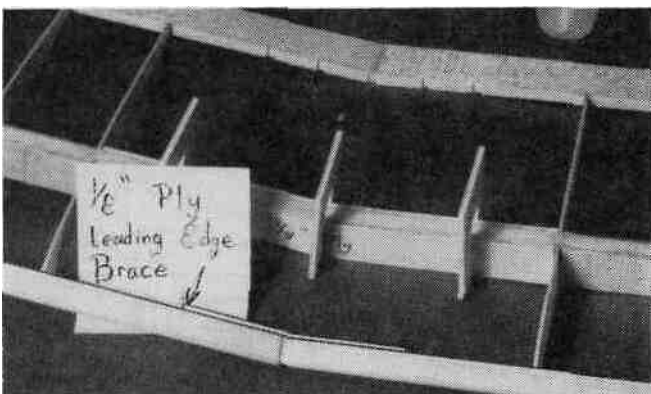

D 9. Glue the **1/8" Plywood Leading Edge Brace** in place using thick CA. It should be centered (up and down) on the leading edge because 1/16" sheeting will be added above and below it later.

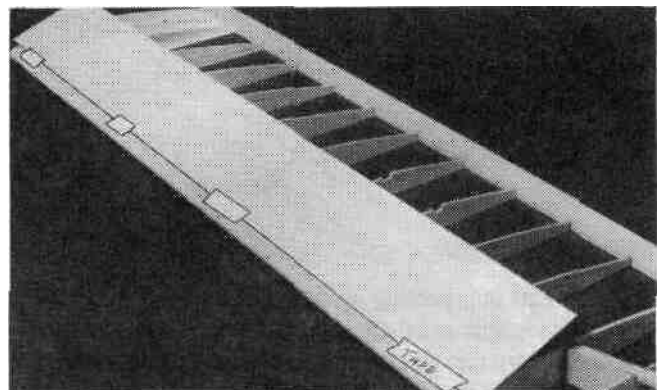

D 13. Sand the top LE surface of the ribs with a sanding block to remove any bumps or high spots, but be very careful not to change the shape of the airfoil. Set the 1/16" x 3" x 24" Balsa Leading Edge Sheeting (SPRTW17) in place on the inner panel. The outer end of the sheeting should cover rib W3A. Apply several strips of masking tape to hold it in place and act as a hinge for the gluing process.

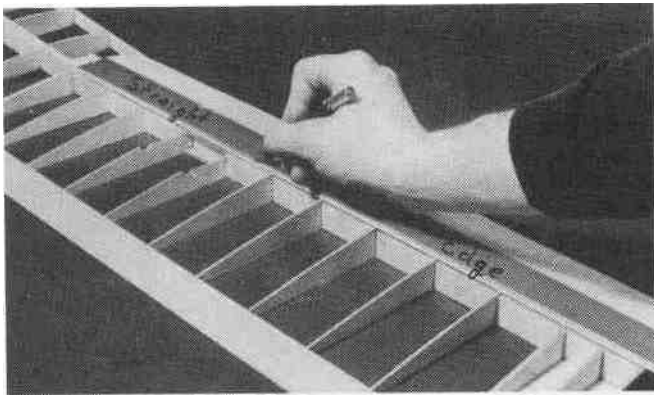

D 14. Press the sheeting into place and trim it flush with the back edge of the spar using a modeling knife and straight-edge.

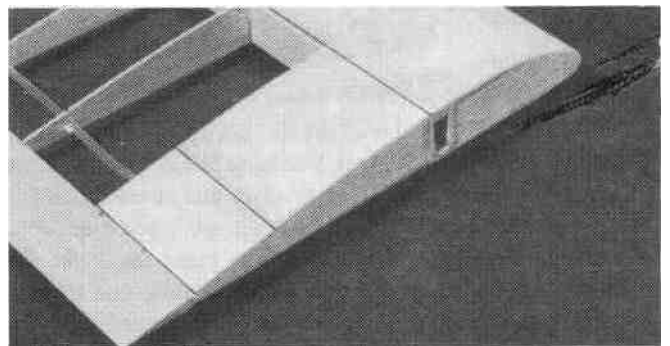
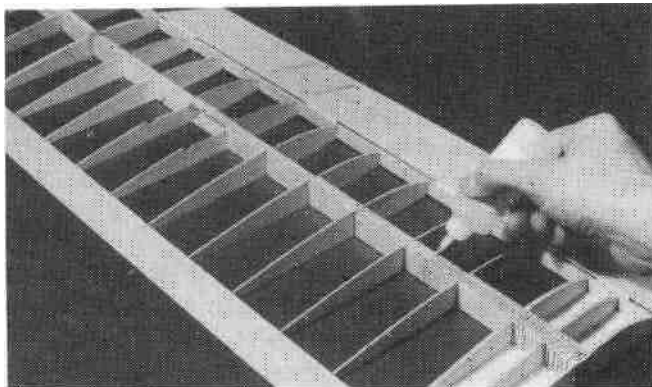
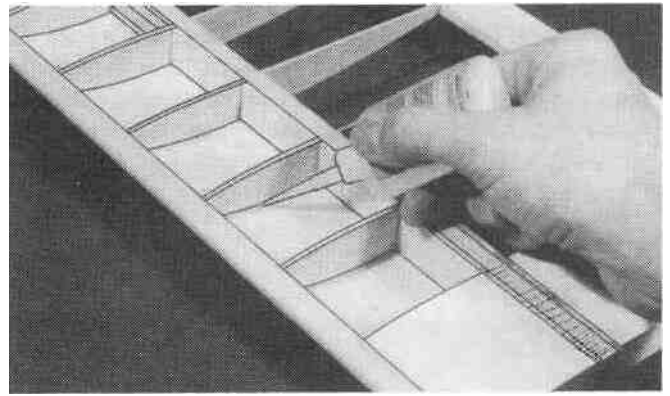

D 17. Use the remaining 1/16" balsa sheeting to sheet the top inboard center section out past rib **W1B** as shown in the photo. Thick CA should be used for this step. Glue the first piece near the spars, and add the final piece near the trailing edge. Sand the sheeting flush with the **W1A** and **W1B** ribs at the wing root.

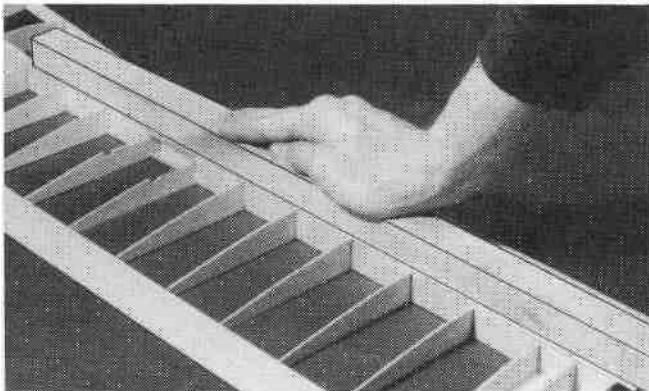

D 18. If you built a two-piece wing, trial fit the two wing halves together using the plywood wing joiner. Sand the root of each panel if necessary to achieve a nice fitting joint between the two wings. If there are large gaps, glue a scrap piece of 1/16" balsa to the root of each panel and sand it to fill the gap.

D 15. Lift the sheeting up and apply a bead of thick CA along the top spar and the second **W1A** rib. Quickly press the sheeting down into place and hold until the glue has cured. A **straight** strip of wood the length of the panel can be a big help when trying to hold the sheeting down evenly.

D 16. Apply a small bead of thin CA between the pieces of masking tape along the leading edge. When all of the glue has cured, remove the tape, flip the wing over and securely glue the sheeting to the ribs and the leading edge using thin CA. The photo for this step is at the top of the next column.

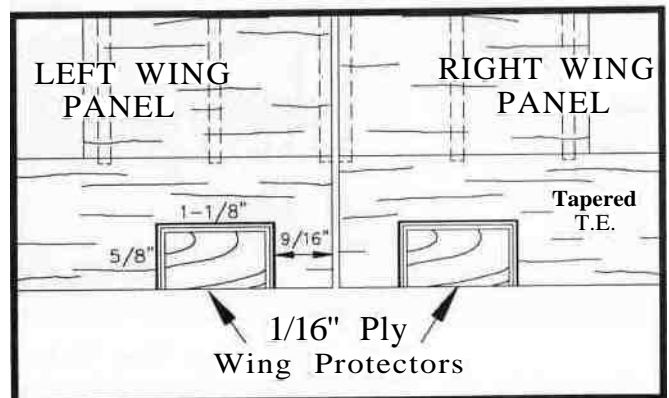

D 19. Sand three edges (two short and one long edge) of each 1/16" **Plywood Wing Protector** (SPRTW18) to a taper

as shown on the plans and glue them in place on top of each trailing edge. They should be oriented so the unsanded edge is flush with the back of the trailing edge and they should be placed 9/16" away from root of the wing. These will protect the wing trailing edge from being dented by the rubber bands.

FUSELAGE ASSEMBLY

You'll need the following items:

SPECF01	3/32" Balsa Fuselage Sides and Wing Saddle Tripler
SPECF02	3/32" Balsa Fuselage Doublers
SPECF03	1/8" Plywood Front Fuselage Bottom
SPRTF04	1/16" Balsa Rear Fuselage Sheeting
SPECF05	1/8" Plywood Formers
SPECF07	1/8" Plywood Formers
SPECP08	3/16" x 15" Balsa Triangle
SPECF13	1/16" Balsa Nose Cap and Rear Doubler
SPECF15	Balsa Top Nose Block
DOWEL030	1/4" Hardwood Wing Dowel

ASSEMBLE FUSELAGE SIDES

D 1. Pin or tape the fuselage plan to your flat work surface and cover it with waxed paper. Lay one of the 3/32" **Die-Cut Balsa** Fuselage Sides (SPECF01) down ABOVE the FUSELAGE SIDE VIEW so you can use the plan for reference. This is going to be the **LEFT** fuselage side.

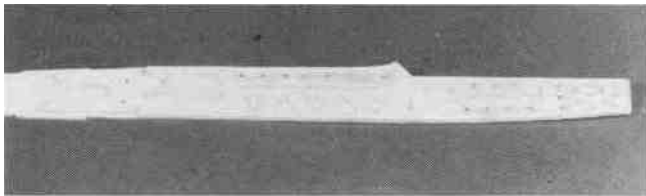

DD 2. Trial fit one of the 1/16" **Die-Cut Balsa Front Fuselage Doublers** (SPECF02) onto the 3/32" **Balsa Fuselage Side**. Line up the doubler so the edges of it are even with the edges of the fuselage side (except the front). Note that the doubler is 1/8" shorter in front than the fuse side. It is important to get this doubler properly aligned since all of the formers will key into it. With the doubler in place, apply thin C/A around all edges and cutouts. Use a T-Pin to poke a few

holes, about 1/2" apart, where the black dots are in the photo and apply a couple of drops of thin C/A to each hole. The thin C/A will soak into the wood and provide a good bond.

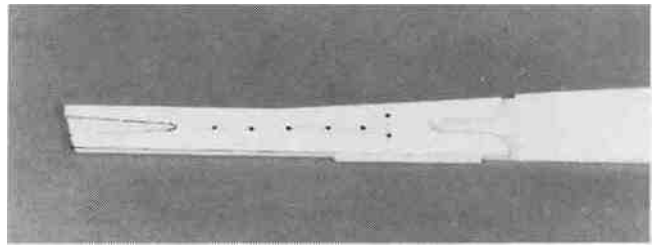

DD 3. **Glue the 1/16" Die-Cut Balsa Rear Fuselage Doubler** (SPRTF13) in place making sure it lines up with the fuselage side. Use a T-pin to poke holes where the black dots are in the photo and put a couple of drops of thin C/A in each hole and around the edges.



DD 4. **Glue one of the 3/32" Die-Cut Balsa Wing Saddle Triplers** (SPECF01) in place on top of the front fuselage doubler. The tripler should be flush with the top of the doubler but do not let it overlap the notches for the formers. Sand the edges of the doublers/tripler flush with the edge of the fuselage side.

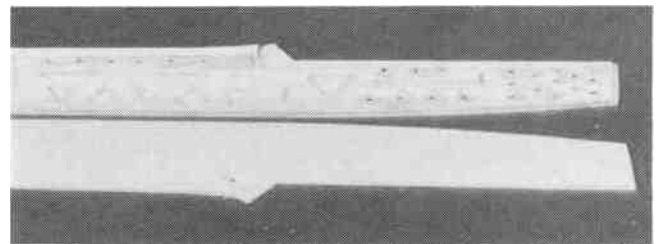

D 5. Go back to step 2 and assemble the **RIGHT** fuselage side. The easiest way to do this is to lay the other fuselage side upside down below the one you just built as shown in the photo. **MAKE SURE YOU ARE NOT BUILDING TWO IDENTICAL SIDES, THEY SHOULD BE THE OPPOSITE OF EACH OTHER.**

FRAME-UP THE FUSELAGE

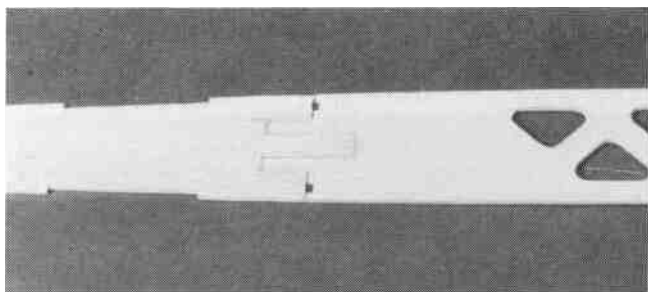

D 1. Lay a piece of waxed paper over the FUSELAGE TOP VIEW. Assemble but do not glue yet, the 1/8" **Die-Cut Plywood Front Fuselage Bottom** (SPECF03) and the 3/32" **Die-Cut Balsa Rear Fuselage Bottom** (SPRTF04) together over the FUSELAGE TOP VIEW on the plans. Make sure the bottoms are aligned with the plan and that both pieces are pushed firmly against the work surface to even up the bottoms. If the joint is a nice tight fit, apply thin CA to the joint. If the joint is a little loose, take the bottoms apart, apply thick CA and reassemble them.

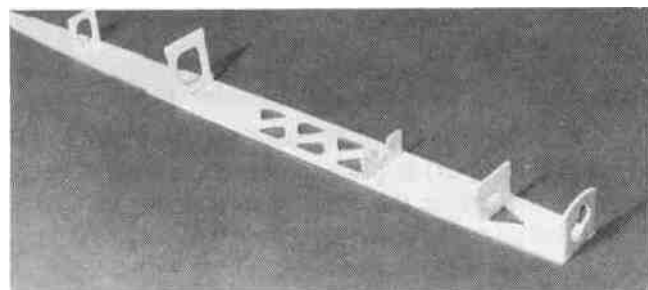

D 2. Trial fit all of the 1/8" **Plywood Formers** (except F1B and F4) in their respective notches in the fuselage bottom and sand them if needed to make them fit properly. **NOTE:** make sure the indented "dots" on former F1A are facing forward so you can see where to drill the motor mounting holes later.

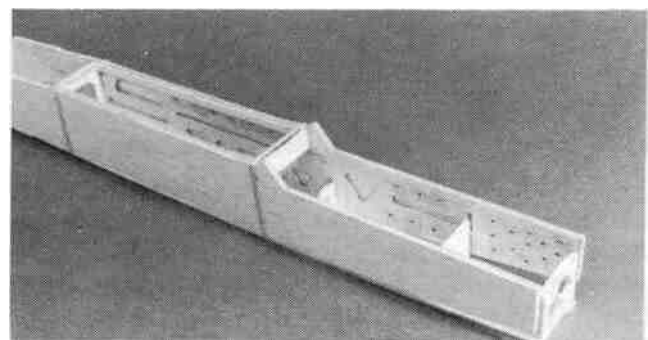

D 3. Align the fuselage sides with the fuselage bottom and position the formers so they will key into the notches.

Install former F4 and press the sides into place. Use rubber bands near formers F4 and F5 to hold everything together and apply thin C/A around formers F3, F4 and F5.

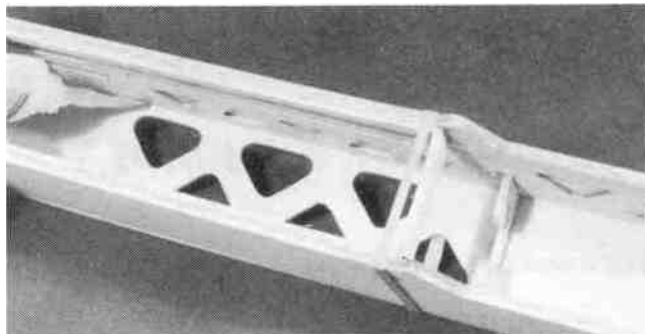

D 5. Align the fuselage sides with the fuselage **bottom** between formers F3 and F5 and apply thin CA along the joint.

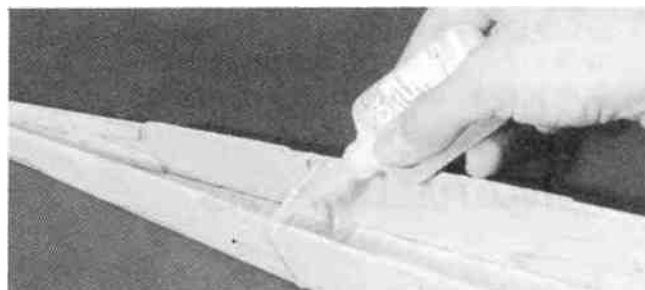

D 6. Pull the rear fuselage sides together and press the sides firmly against former F6. A couple of C2 clamps can be used to hold the tail of the fuselage together and a rubber band will help around the former. Apply a couple drops of CA on the back edge of the rear fuselage doubler and a bead of thin CA along the bottom sheeting joints and around former F6. Take your time applying the thin CA and be sure to gel the bottom and the sides pressed together nicely. Thick CA should then be added to these joints to add strength.

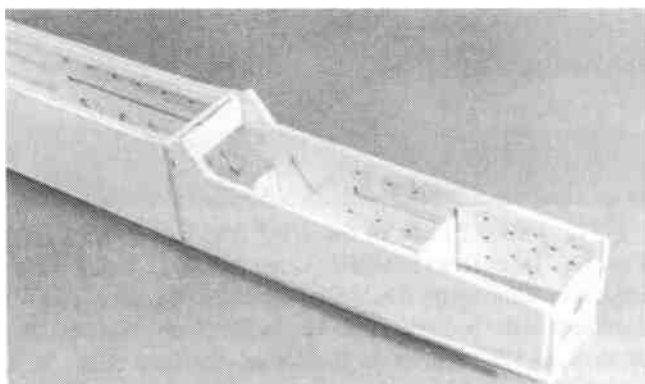

D 7. Pull the front fuselage sides together so the formers will key into place and use a rubber band to hold them. Apply thin CA along the fuselage bottom and the around the formers.

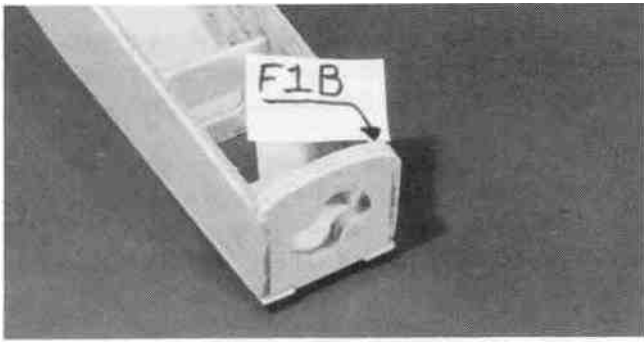

D 8. Trial fit Former F1B (SPECF05) in place and sand if necessary to make the cutout in it line up with the cutout in former F1A. Glue it in place against F1A with **thick CA**. Note that F1B is slightly taller than F1A. Sand the fuselage sides and bottom flush with the face of former F1A.

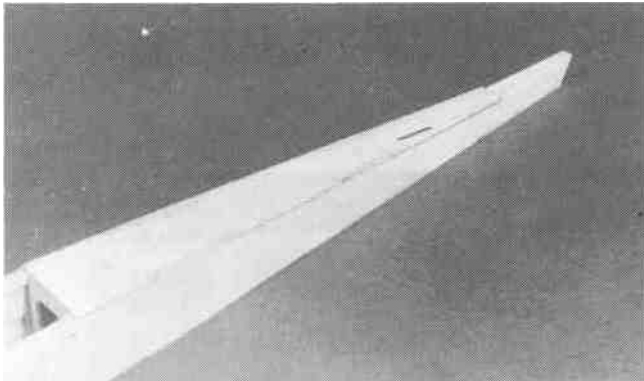

D 9. Trial fit the 3/32" **Balsa Rear Top Fuselage Sheet** (SPRTF04) in place*, and when satisfied with its fit apply CA to glue it in place. *NOTE: The top sheeting should be installed so the rudder pushrod cut-out is on the left side of the fuse. Check the plans for the proper orientation.

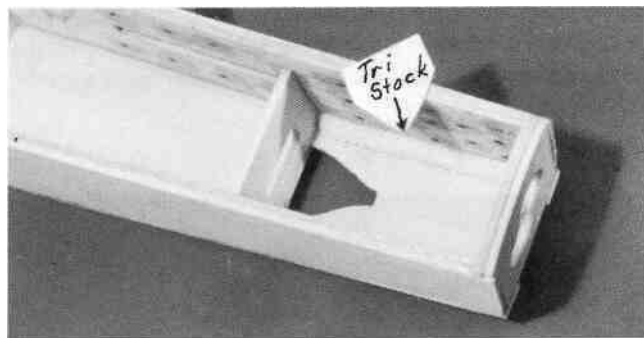

D 10. Cut two pieces of the 3/16" Balsa Triangle (SPBCF08) 2-7/8" long and glue them in the corners between the fuselage bottom and the fuselage sides behind former F1B.

D 11. Glue the die-cut 1/8" **Ply Canopy Hold Down Plate** (SPECF05) to the back face (most slanted end) of the **Balsa**

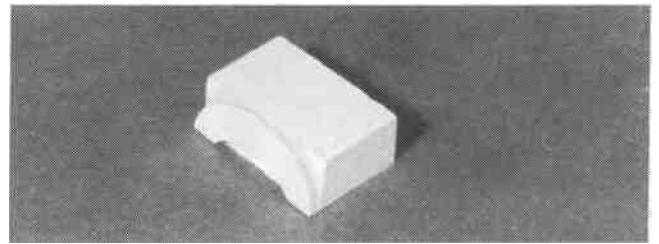

Top Nose Block (SPECF15). Make sure both pieces are flat against the work surface, as shown in the photo, when gluing.

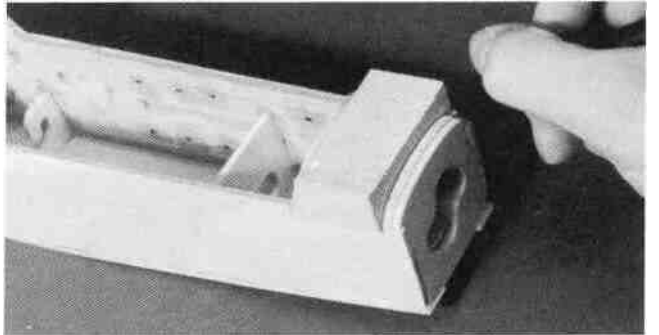

D 12. Hold this assembly in place against the fuselage sides and former F1B and mark around the top of F1B.

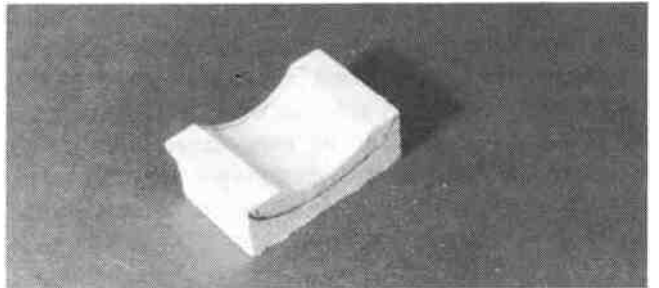

D 13. Use sandpaper wrapped around a wooden dowel or other round surface and sand out a "trough" in the nose block so it will clear the motor. Use the cut-out on the canopy hold down plate as a pattern for the trough.

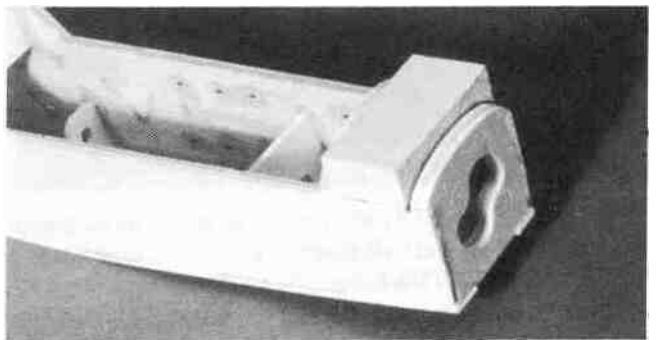

D 14. Sand the front edge of the noseblock at a slight angle to fit up against former F1B. Glue the nose block/hold down plate in place on the fuselage. It should be pressed up against former F1B.

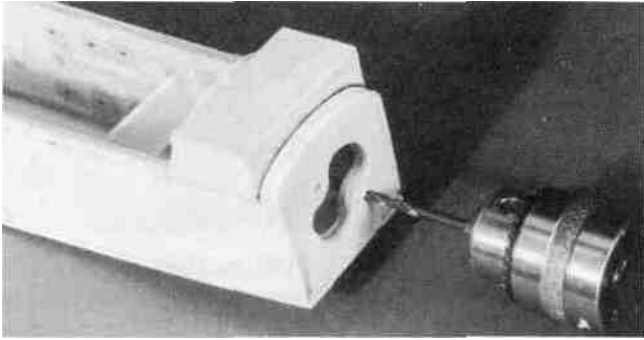

D 15. Drill a 1/8" dia. hole at both "dots" on former F1A. Try to drill straight in with the drill perpendicular to the former.

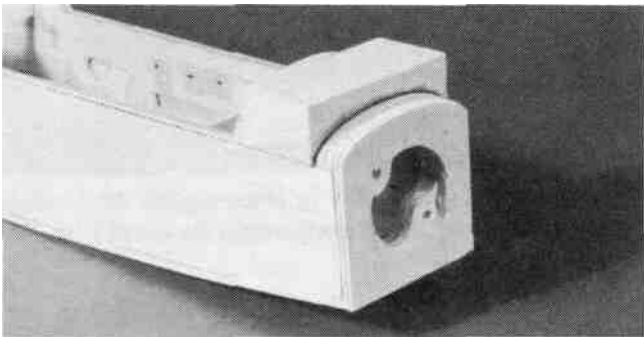

D 16. Accurately position one of the **Die-Cut 1/16" Balsa Nose Caps** (SPECF13) on top of the other Nose Cap so they are aligned with each other and glue them together with CA. Glue these to former F1A using thick CA. NOTE: make sure the nose cap is installed so the motor screw holes are not covered up. Refer to the cross section view to the right of the title block on the plans for proper orientation of the nose caps.

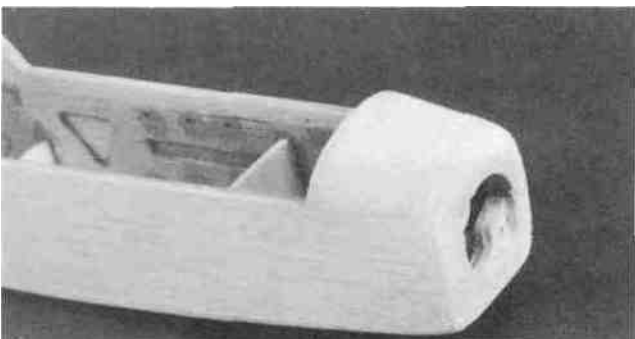

D 17. Carve and sand the nose area as shown in the photo. Sand formers F1A and F1B to achieve a smooth nose but **DO NOT SAND INTO THE CANOPY HOLD DOWN PLATE - It needs to match up with the canopy later!** Sand all edges of the balsa nose cap to blend nicely with the fuselage. Also sand all corners of the fuselage to smoothly round them as shown on cross section views on the plans.

D 18. Apply a small bead of thick CA along all previously glued joints to help reinforce the joints. Be careful though and don't use more glue than is actually needed.

D 19. Chamfer (slightly round) the ends of the 1/4" x 3-1/2" Wing Dowels (DOWEL030) and insert them into the holes near the wing saddle area of the fuselage. **DO NOT GLUE THEM IN UNTIL AFTER COVERING THE FUSELAGE** - This makes it easier to cover!

ASSEMBLE THE CANOPY

You'll need the following items:

SPECF06	1/8" Balsa Canopy Base
SPECF05	1/8" Plywood Canopy Front and Back
CANPY045	Clear Canopy
DOWEL035	1/8" X 3/4" Hardwood Dowel

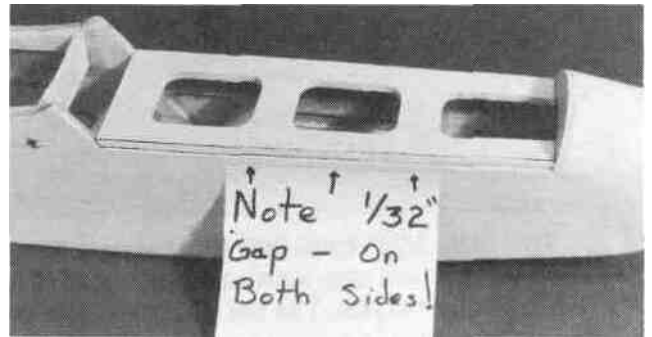

D 1. Trail fit the **Die-Cut 1/8" Balsa Canopy Base** (SPECF06) in place on the fuselage. It should be approximately 1/32" narrower than the fuselage (on both sides) as shown in the photo. Sand the front and back of the canopy base at an angle so it will fit the fuselage nicely. Due to building tolerances, you may also have to sand the sides of the canopy base slightly to achieve the 1/32" clearance with the fuselage sides. This allows the canopy to be flush with the fuselage sides.

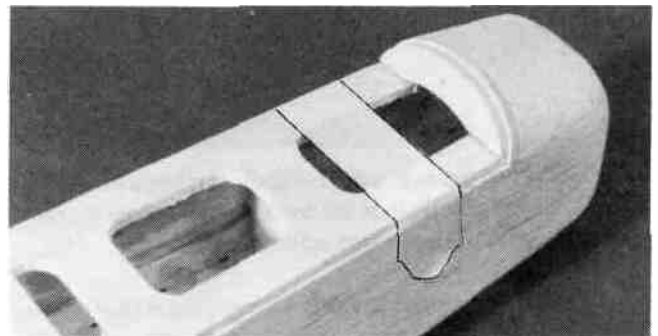

D 2. Center the canopy base on the fuselage and tape it in place with masking tape. Tack glue the **Die-Cut 1/8" Ply**

Canopy Front (SPECF05) to the canopy base (with a drop of thick CA on each side). The canopy front should be held against the canopy hold down plate (**with the indented "dot" showing**) while the glue cures. Be careful not to glue the canopy front to the hold down plate.



D 3. Drill a 1/8" dia. hole, approximately 1" deep, through the canopy front, the hold down plate and into the nose block. This hole is for the 1/8" dowel.

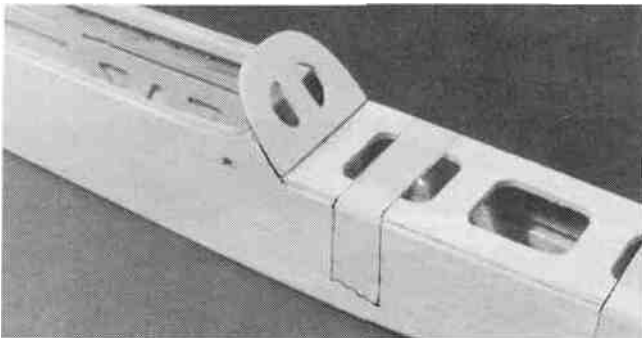

D 4. Tack glue the **Die-Cut 1/8" Ply Canopy Back** (SPECF05) to the canopy base using a couple of drops of thick CA around the middle of the back.

D 5. Remove the canopy frame from the fuselage and apply more thick CA to the joints to securely glue the front and back in place. Sand the corners of the front and back flush with the base. If you are going to add some detail to the "cockpit," now is the time to do that. It looks nice to at least paint the base black or your favorite color. Do not cover up the "air" holes.

D 6. Sand the ends of the 1/8" **Hardwood Canopy Dowel** (DOWEL035) round and glue it in place in the nose of the fuselage. Leave approximately 1/4" of the dowel sticking out of the canopy hold-down plate. If you painted your canopy base, you should also paint the exposed end of the dowel to match.

D 7. **Remove the blue plastic film from the Canopy** (CANPY044). Tint the Canopy if you wish, using regular clothing dye that you can buy at the grocery store (Rit, etc). Use hot tap water, but not hot enough to deform the canopy.

Test the temperature with a scrap cut from the canopy. The warmer the water and the longer you leave the canopy in the dye, the darker the tint will be. It is not uncommon to have to leave the canopy in the dye for a couple of hours for a dark tint.

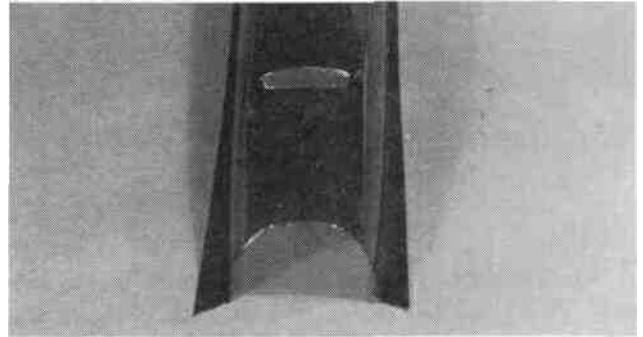

D 8. Use a dremel tool with a cutting bit or a drill and knife to cut out the back surface of the air vent in the canopy. Take your time and be careful when cutting this out so you don't cut yourself or ruin the canopy. Cut the front and the back off of the canopy, but do not cut past the scribe lines on the canopy.

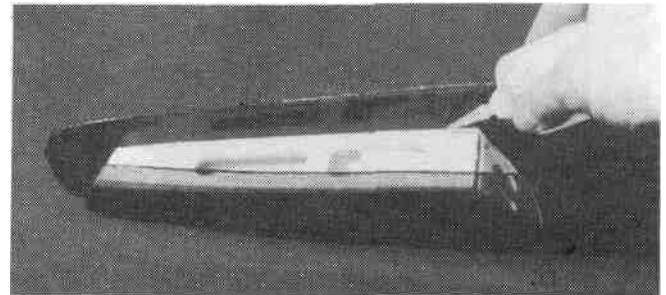

D 9. Test fit the canopy onto the frame. Center the frame in relation to the scribe marks on the canopy but make sure the frame is not touching the air inlet. The scribe lines are only there for reference and are placed approximately 1/16" away from where the canopy frame will fit. Wipe any dust off the inside of the canopy and glue the canopy to the frame using CA glue as follows. Start by gluing the top of the frame front and the top of the frame back in place and then working your way around the frame. Use the glue very sparingly by applying only one drop at a time and allow it to cure before continuing. The glue will seep in along the seam and provide a nice clean glue joint. Don't get in a hurry or you may get too much glue in there and it will run down the canopy. Be careful not to twist or move the canopy base while gluing it in place.

D 10. Trim the canopy flush with the base and the front but do not trim the back yet! A small pair of scissors works well for trimming the canopy. Sand the edges of the canopy flush with the frame base and front. The photo for this step is at the top of the next page.

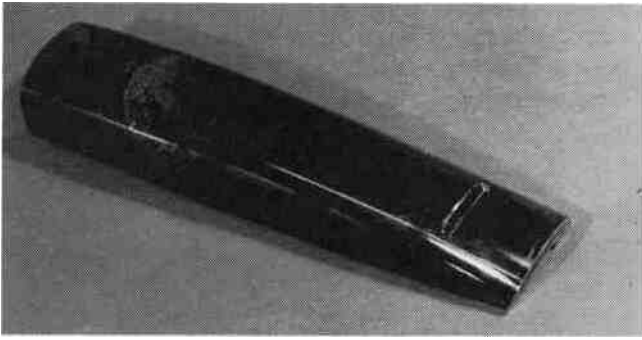

back of the canopy compartment as shown in the photo. This is the **Canopy Aligner**. Lift the aligner so that it is slightly above the sides. Apply a small drop of thick CA to the middle of the aligner and carefully slide the canopy into place. Push down on the canopy to force the aligner against the canopy base (with the canopy aligned with the fuselage sides) and hold it until the glue has cured (a couple of minutes). Carefully remove the canopy and securely glue the aligner to the canopy base with more CA. A drop of thin CA on each end of the aligner will harden it and make it last longer.

D 14. Install the canopy again and check to make sure the nose and the fuselage sides blend smoothly into the canopy. Use your sanding block with medium or fine grit sandpaper to smooth out any high spots.

INSTALL MOTOR

D 1. Apply one drop of oil to the front and rear motor bushings. Install the motor by sliding it in from the rear of former F1. Use the **3mm x 10mm** Screws(SCRW056) to hold it in place. These screws should be firmly tightened but do not tighten them so tight that they crush the wood.



D 11. Temporarily mount the wing in place on the fuselage. **VERY CAREFULLY** trim the back of the canopy along the scribe lines, **A LITTLE AT A TIME**, to fit over the wing. The scribe lines are just a reference, so take your time and trial fit the canopy in place often to check your progress. Once you get the canopy to clear the wing by approximately 1/16", round off the back part with sandpaper to make it look nice.

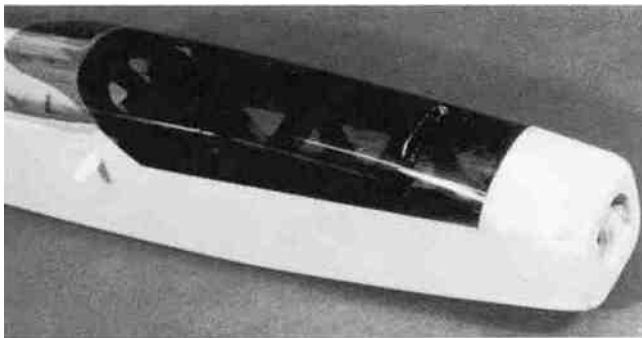

D 12. Test fit the canopy onto the fuselage. You can sand the edges of the canopy slightly or you can sand the fuselage if needed to get it to fit properly.

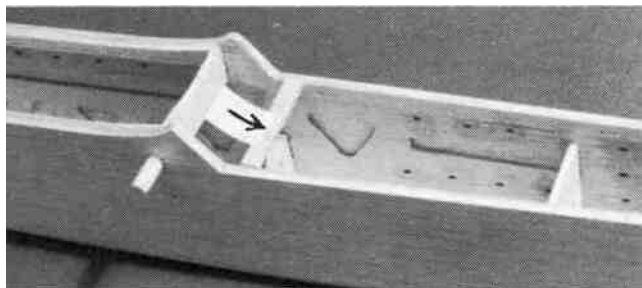

D 13. Cut a piece of **1/8x3/16"** Balsa (from SPRTS03), 1-15/16" long and wedge it between the fuselage sides near the motor. Install the hub/prop/spinner assembly onto the motor shaft using the **6-32 x 1/4"** Set Screw (SCRW038) and the

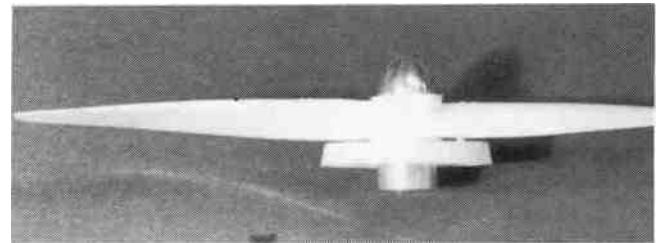

D 2. Install the prop on the hub using the 6-32 x 5/8" Socket Head Screw (SCRW037) and the 7/64" Hex Wrench (WRENCH02). If you are also installing a spinner with a backplate that goes behind the prop, substitute the 6-32 x 3/4" Socket Head Screw (SCRW057) for the 5/8" screw. Make sure you tighten the prop screw so it will not come loose while the prop is spinning.

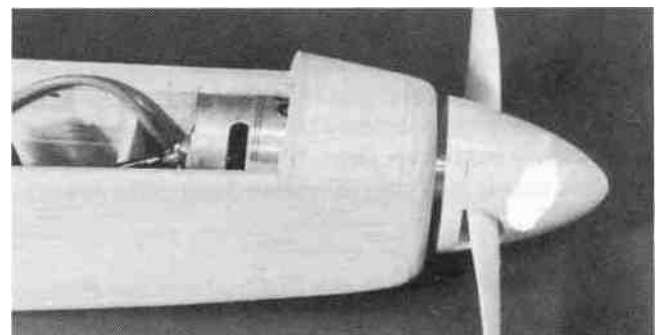

supplied 1/16" **Hex** Wrench (WRENCH01). Push the hub onto the motor shaft until it stops. At this point there should be at least a 1/16" gap between the spinner backplate and the nose cap. If there is not enough clearance you can either sand back the nose cap or you can move the hub out 1/16" on the shaft (but do not move it out any more than 1/16" from its "fully on" position). When satisfied with the clearance, remove the prop assembly until after the plane is covered.

FINAL ASSEMBLY

BALANCE THE AIRPLANE Laterally

SPECIAL NOTE: Do not confuse this procedure with "checking the C.G." or "balancing the airplane fore and aft". That very important step will be covered later in the manual.

Now that you have the basic airframe nearly completed, this is a good time to balance the airplane **laterally** (side-to-side). Since the wing is the major factor on a sailplane, we will only be concerned with it. Here is how to do it:

D 1. Set the wing on a flat surface and hold it so that both wing tips are level. Let go of the wing and notice which wing tip drops. Do this several times and if the same wing tip keeps dropping push a thumb tack or small nail through rib W10 into the wing tip that keeps rising.

D 2. Perform this test several times until the wing balances or the same wing tip does not drop every time and then glue the tacks or nails in place with a drop of thin CA.

FINAL Sanding

D 1. Harden the balsa in the area of the control horns (on both control surfaces) by poking several holes with a pin, then applying thin CA glue.

D 2. Check over the entire structure carefully, inspecting for any poorly glued joints, gaps and "dings". Apply additional glue and/or balsa filler as necessary, then sand the entire structure smooth using progressively finer grades of sandpaper.

Covering

There are many different types of covering materials available these days but the iron-on type coverings are by far the easiest to use and in most cases the best suited for the job.

There are also several different brands of iron-on coverings available. We recommend you use Top Flite Super Monokote for covering your SPECTRA due to this covering's higher strength. Sailplanes, which usually have higher "aspect ratio" wings (long and thin), gain a great deal of strength from the covering. This is evident by gently twisting the wing before and after it is covered, it is hard to believe the difference. Because of this, the higher strength coverings are best suited for sailplanes.

The following are some covering tips we have learned over the years but you should **follow the instructions included with your covering material.**

- Sand the surfaces as smooth as possible before starting to cover the plane. The finished covering job will only be as smooth as the surface you started with.
- Use a fresh single-edge razor blade or hobby knife blade and replace the blade as soon as it starts showing signs of dulling.
- **Set the iron to the proper temperature by first applying a "test strip" on a scrap of balsa.**
- Work outward on sheeted surfaces, start by tacking the covering in place at the corners and then start in the middle and work your way out to the corners, gently pulling any wrinkles out as you go.
- Securely seal all edges! Make sure the edges are firmly sealed down to prevent the covering from pulling away at the seams when shrinking the covering over open structures.

NOTE: When covering the fin, begin by applying a 1/2" wide strip of covering on each triangle. Next, cover the rest of the fin with pre-cut pieces that have a straight edge to overlap (1/8"+ overlap) the strips you previously applied. This is a tip you should remember as it makes it a lot easier to cover "compound" curves.

Because the fin has to glue on top of the stab and the stab must later be glued to the fuse, you do not want to cover where these surfaces will glue to each other. The following instructions will explain how to do this.

D 1. Position the stabilizer on the fuselage and measure **to** get it centered. Hold it in place and mark along the fuselage/stabilizer joint with a felt pen to show where not to cover.

D 2. Position the fin in place on top of the stab. Make sure it is centered and pointing straight ahead, and mark around the base with a felt tip pen.

0 3. When applying the covering to the top and bottom surfaces of the stab, do **each** side with **two** pieces of covering. Do not cover between the lines. Cut the covering to fit around

the lines **before** you iron it in place. Also **do not** cover each surface of the stab with one sheet of covering and then cut the covering away between the lines. Doing this leaves "cut lines" in the wood and greatly weakens the stab structure.

Recommended Covering Sequence:

1. **Strips as described in above note**
2. Fin left side
3. Fin right side
4. Rudder left side
5. Rudder right side
6. Bottom of elevator
7. Top of elevator
8. Stab bottom right side
9. Stab bottom left side
10. Stab top right side
11. Stab top left side
12. Fuse bottom
13. Fuse sides
14. **Fuse top**
15. Bottom of left wing panels (inner and outer)
16. Bottom of right wing panels (inner and outer)
17. Top of left wing panels (overlap covering 1/4" at LE, TE and polyhedral joint)
18. Top of right wing panels (overlap covering 1/4" at LE, TE and polyhedral joint)

CHECKING FOR WARPS

This is a very important step and should be done every once in a while throughout the flying season. A sailplane's wing is **most efficient** when it is not twisted or warped at all. "Washout" (wing trailing edge twisted up at the tip) helps make a poor wing design fly better by adding some stability (preventing stalls) at slow speeds but it cuts down on the wing's efficiency at normal speeds. The SPECTRA'S wing is designed to fly well at slow speeds without any washout, and therefore we recommend you check to make sure the wings are "flat" using the following procedure.

D 1. Set the wing so an inner panel is resting on a flat surface. Any warp (twist) will show up by causing a corner of the panel to rise off of the work surface.

D 2. To remove the warp, gently twist the wing in the opposite direction while a helper glides an iron or heat gun over the covering on both the top and the bottom of the panel to re-shrink the covering. Hold the twist until the covering cools and then recheck for warps. It may take several tries to get a warp out but it is worth it as you will end up with a sailplane that flies straight and true and responds to air currents like a high performance sailplane should.

D 3. Follow the same procedure to check all four wing panels and then go back and double check them. Sometimes you put a warp in one panel while trying to fix another. You should also look at the tail surfaces as they too can warp.

GLUE THE HINGES

D 1. Lay the rudder and elevator on the plans and mark on the leading edge of each part the locations of the hinges. Now use a sharp hobby knife to cut slits in the covering at the hinge locations. Trial fit the hinges to make sure you have "found" the slots which you previously cut. In the same manner, slit the covering at the hinge locations in the stab and fin TE.

D 2. When gluing the hinges it is important that plenty of glue gets inside the hinge slot. If you just put glue on the hinge, most of it will be wiped off as the hinge is inserted into the slot. A good way of getting glue into the slot is to scoop up some epoxy with a plastic soda straw, then pinch the end of the straw, insert it into the slot, and squeeze the straw to force the glue into the slot. Apply epoxy to the hinges, insert them into place (up to the middle of the hinge) and wipe away **all** excess epoxy with a tissue (for best results dampen the tissue with rubbing alcohol). **NOTE:** When using hinges other than those supplied, follow the manufacturer's instructions.

MOUNT THE TAIL SURFACES

D 1. Insert the 1/4" wing dowels in the holes and secure with thick CA.

D 2. Rubber band the wing onto the fuselage making sure it is square and centered with respect to the fuselage.

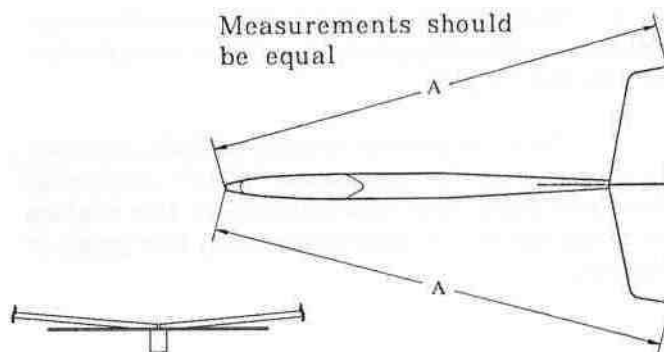

D 3. Position the stabilizer on the fuselage and measure to get it centered and properly aligned. Glue the stabilizer to the fuselage with either thick CA or epoxy. Check its alignment with the wing while the glue is curing to make sure they are parallel with each other.

D 4. Trial fit the fin in place on top of the stab. Trim it if necessary to get a close fit. Glue the fin in place on top of the stab using either thick CA or epoxy. Check to make sure it is pointing straight at the nose and is vertical (90 degrees) to the stab.

ASSEMBLE PUSHRODS

You'll need the following parts:

- SPECF09 1/4" Square Balsa Pushrod •
- WIRES 10 36" Wire (Threaded both ends)
- NYLON03 Nylon Control Horns

D 1. Tack glue the Nylon Control Horns (NYLON03) in place on the rudder and elevator with a drop of thin CA. Use the plans as a reference for positioning the horns (Rudder horn on the **left**, elevator horn on the **bottom**). Drill two 3/32" holes through the control surfaces using the control horns as guides. Mount the horns with the 2-56 x 3/8" Screws (SCRW001) and the **Nylon Nutplates** which were attached to the horns.

D 2. Cut 5-1/4" off both threaded ends of the 36" **Wire** (WIRES 10) and then cut two pieces 12" long from the remaining piece of wire. Bend them as shown on the plans except without the Z-bends. The Z-bends are not bent until later. Refer to the fuselage "TOP" and "SIDE" views for the proper bending of the pushrod wires. Wipe off each wire using a paper towel dampened with rubbing alcohol to remove any oil.

D 3. Cut the pushrods from the 1/4" x 11-7/8" **Square Balsa Sticks** (SPECF09). The elevator pushrod should be 11-1/8" long and the rudder pushrod should be 8-3/4" long.

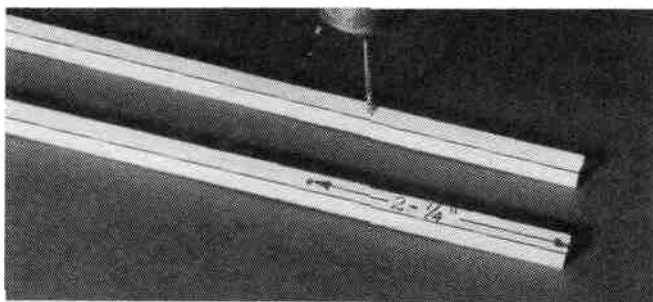

D 4. Drill a 5/64" hole 2-1/4" in from both ends of each **pushrod**.

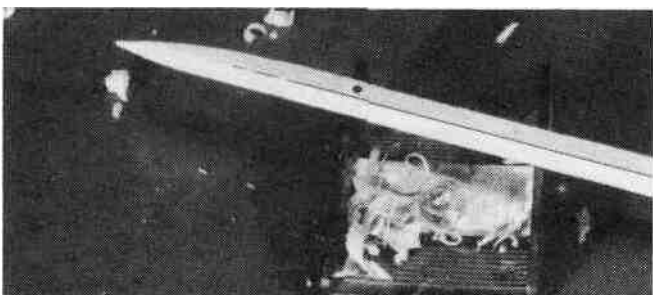

D 5. Use either a hobby knife, razor plane or coarse

sandpaper to taper **three** sides on each end of both pushrods. The taper should start about 1-1/2" from the end. (One of the sides with the 5/64" holes should remain flat).

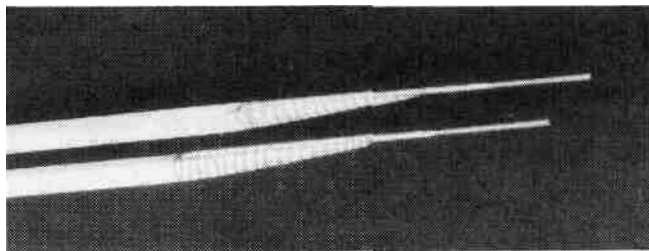

D 6. Insert one threaded piece of wire into each pushrod. Insert the 12" pieces of wire into the other end of each pushrod. Tack glue the wires in place with a couple drops of CA. Firmly wrap the end of the pushrod with strong thread and apply thick CA to hold everything in place as shown on the plans and in the photo.

INSTALL RADIO GEAR

D 1. Read and follow the instructions that came with your radio to install or charge the transmitter and receiver batteries and get the servos ready for mounting. Plug the servos and the battery pack into the receiver and turn on the **transmitter first** and then the receiver. Adjust the trim levers to their neutral positions and allow the servos to return to their neutral positions.

D 2. Slide one of the 1/4" x 3/8" Basswood Servo Rails (SPRTF11) into its slot in the rear of the fuselage doubler. Slide it all the way towards the back of the slot and glue it in place with thick CA. Slide the other servo rail into the slot and then slide it all the way forward. Do not glue it yet! Position one of your servos in place and use it to position the front

servo rail. **Do not** push the front servo rail up tight against the servo but rather leave about a 3/32" **gap** between the servo "body" and the rear servo rail. This will give you enough room to get the servos in and out without removing the rails. Glue the front servo rail in place.

D 3. Position both of the servos together in the middle of the rails and mark where the holes for the servo mounting screws should be drilled. Remove the servos and drill 1/16" holes where the marks are. Install the servos, with the wires exiting forward, using the servo mounting screws that came with the radio.

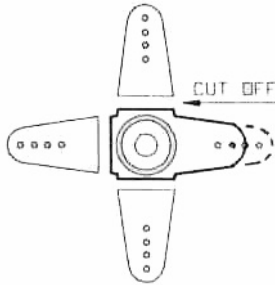

D 4. Cut three "arms" *off of two* X-type servo horns using wire cutting pliers or a razor saw as shown in the sketch. Install the two servo horns with the arms facing opposite directions as shown on the plans. Turn on the radio and operate the transmitter sticks to make sure the servo horns turn freely without hitting each other or the fuselage sides. If they hit, cut or sand them until they will operate freely. Turn off the **receiver first** and then the transmitter.

IF YOU ARE NOT USING A THIRD CHANNEL FOR THROTTLE CONTROL - JUST TAPE THE MICRO SWITCH "CLOSED" AND SKIP AHEAD TO STEP 9.

D5. Glue one of the 1/8" x 3/8" x 1" Ply Throttle Servo Rails (SPECF14) in place in the forward end of the slot. It should be level and up against former F2. Use your servo to space where the other servo rail should be and glue it in place. Since this servo rail is only connected to the fuse side it will have to be securely glued in place. A scrap of balsa can be used underneath the rear rail to help brace it





2 X 3/8"
SCREW

D 6. Screw the #2 x 3/8" Sheet Metal Screw (SCRW024) into a servo wheel, from the bottom, until there is only 1/8" between the head of the screw and the servo wheel. Cut off

the exposed point and sand the top of the servo wheel smooth. Install the horn on the throttle servo so that at full throttle the screw is about 30 degrees past the middle of the servo body as shown in the sketch.

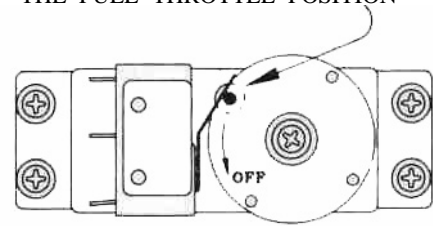
THROTTLE SERVO SHOULD ROTATE TO HERE WHEN TRANSMITTER STICK IS IN THE FULL THROTTLE POSITION



D 7. Bend the arm on the micro switch as shown in the sketch and cut a small piece of the Double Sided Tape (FTAP001) to fit the micro switch. Stick the micro switch to the servo as shown. Test the operation of the switch by turning on your radio and moving the left transmitter stick to make sure the switch is turning on and off as the horn rotates. The switch should be depressed when the transmitter stick is pushed towards the top of the transmitter. When satisfied with the operation of the switch, turn off your radio and secure the switch to the servo by wrapping with a narrow strip of strapping tape.

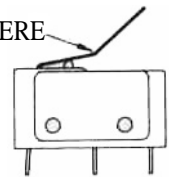

D 8. Install the throttle servo using the screws provided with your radio. Drill 1/16" holes in the rails for the screws, but be careful you don't break the rails loose. Since there are no forces applied to this servo, two screws, one on each side as shown in the photo below will be enough to hold it in place.

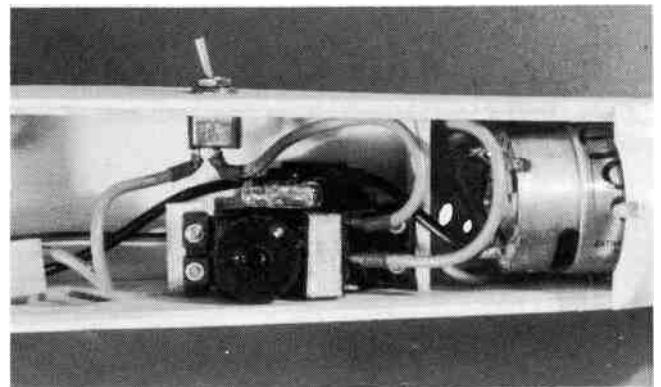

The throttle servo can be facing either direction to suit your installation.

D 9. Drill a 1/4" hole in the LEFT fuselage side, opposite of the throttle servo approximately 7/8" below the top edge of the fuse. Remove one nut and the two washers from the toggle switch and install it as shown in the sketch and photo.

CAUTION - This switch should be kept in the OFF position until ready to run the motor. If you are not using a throttle control, this switch alone will turn on the prop. DO NOT PLUG THE BATTERY INTO THE SWITCH HARNESS UNLESS YOU ARE PREPARED TO RUN THE MOTOR. THE PROP IS CAPABLE OF SERIOUS INJURY AND SHOULD BE TREATED WITH THE UTMOST RESPECT!

D 10. Screw a **Nylon Clevis** (NYLON17) onto the threaded portion of each pushrod. Slide the pushrods into the fuselage. The rudder pushrod exits the top of the fuselage just in front and to the left of the fin.



Nylon Clevis

The elevator pushrod exits the hole in the rear of the fuselage. Snap the nylon clevises into the outermost hole in the servo horns. The rudder pushrod goes to the left servo and the elevator pushrod goes to the right servo. **With the control surfaces in their neutral position**, use a felt tip marker to make a small mark on each pushrod wire where they cross the holes in the control horns. Remove the pushrods from the fuselage and make a Z-bend in each wire with the first bend starting where the marks are.

receiver or side of the throttle servo with double sided foam tape. Because the canopy is so easy to remove, there is no need for the switch to be accessible from the outside (this helps cut down on aerodynamic drag and accidental shut-offs during launching as well).

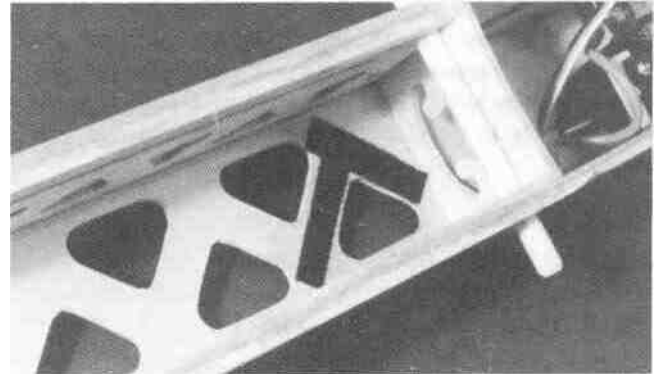

D 14. Soak the fuse bottom behind former F3 (about 2" back) with CA. Allow the glue to cure while you cut the "hooks" piece of Velcro (from VLCRSH02) in half length-wise to make two pieces 3/8" x 1-1/2". Stick the two pieces to the fuselage bottom as shown in the photo. Stick the "loops" half of the Velcro to the forward portion of your 6 or 7 cell battery. See the fuse plan side view.

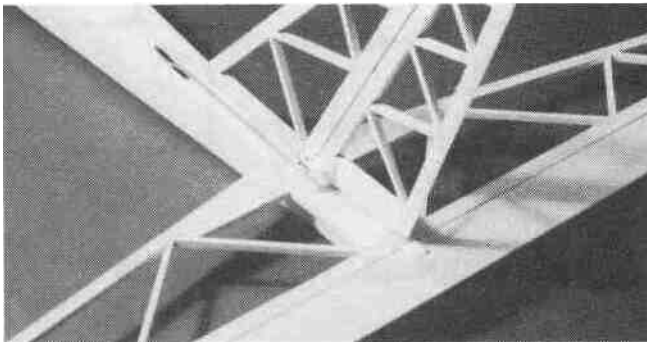

D 11. Cut any excess wire off 1/4" past the Z-bend and reinsert the pushrods into the fuselage. Remove the nylon control horns from the elevator and rudder and install the horns onto the pushrods. Both pushrods should connect to the control horns through the second hole from the inside. Reinstall the control horns to the elevator and rudder. Adjust the nylon clevises until the control surfaces are at neutral when the servo horn is perpendicular to the centerline of the fuselage.

D 12. Pack the receiver in at least 1/4" of foam and install it in between formers F2 and F3. The receiver antenna can run down through the fuselage but try to route it as far away from the servos and servo wires as possible. Allow the excess antenna to trail from the fuselage. **DO NOT CUT THE ANTENNA!**

D 13. The receiver switch can be taped to the top of the

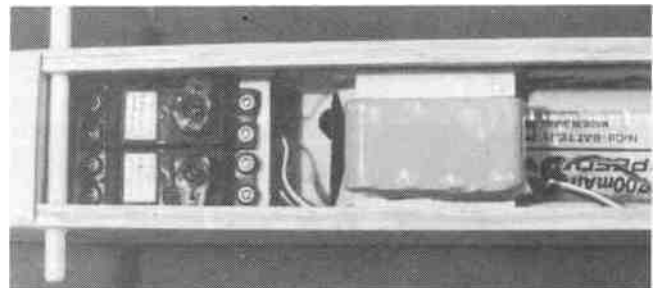

D 15. Prepare the 1/8" x 2" x 2" **Balsa Battery Tray** (SPECF16) by soaking one side with CA. Allow the glue to fully cure and then install it in its slot by first putting it down into the fuselage in one slot and then carefully pulling it up into the other slot. The surface with the CA coating should be facing up. **DO NOT GLUE YET** - we won't glue this tray in position until after we have balanced the airplane. Use the remaining pieces of Double Sided Foam Tape to slick the Receiver Battery to the tray. If you are using a larger (500 mah) battery that won't fit on the tray, you can skip this step and just stick the Rx battery to the 6 or 7 cell battery with double sided tape or velcro. The only drawback to this is you will probably have to remove the wing to change flight batteries.

D 16. Hook up your radio system and test the operation of all controls. The controls should move smoothly without any binding or looseness.

CONTROL THROWS

We recommend the following CONTROL SURFACE THROWS:

NOTE: Throws are measured at the **Trailing** Edge of the elevator and rudder. These control surface "throws" are approximate and provide a good starting point for the first flights with your SPECTRA. You may wish to change the throws slightly to provide the control authority that you prefer.

ELEVATOR: 1/2" up, 1/2" down

RUDDER: 1-1/2" Rt., 1-1/2" Lt.

Move the pushrod wires (Z-bends, nylon clevises) in or out on the control horns and servo horns to achieve the desired movements. If your radio is equipped with "endpoint adjustments" you may set the throws from the transmitter.

FINAL HOOKUPS AND CHECKS

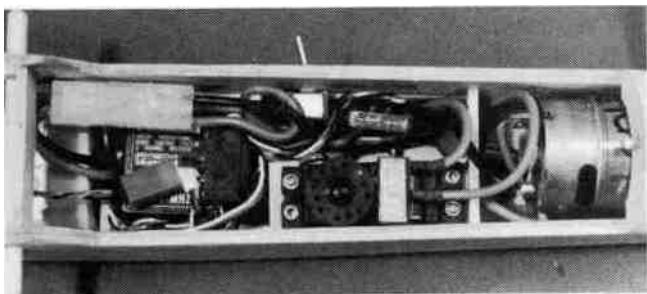

D 1. Install your flight battery. We recommend you use a 7 cell battery for maximum performance, but a 6 cell battery will provide adequate performance under most conditions. Neatly tuck all of the wiring into place. The plans and the photos show a fairly neat way of routing everything.

NOTE: If you are using a 7-cell battery you should replace the 20 amp fuse supplied in the holder with the 25 amp fuse provided.

D 2. Make sure the control surfaces move in the proper direction as illustrated in the following sketch.

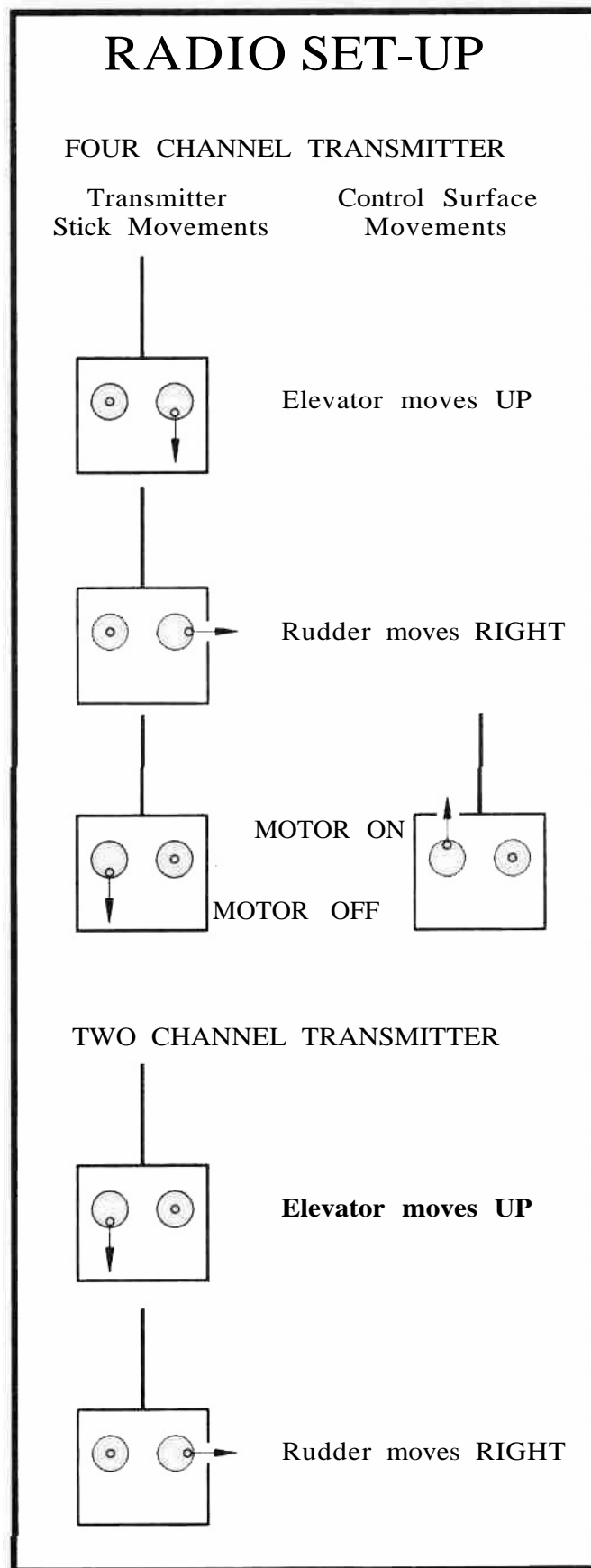

D 3. A piece of self adhesive foam rubber weather striping can be applied to the front of the fuselage bottom to help protect it from getting nicked up during landings.

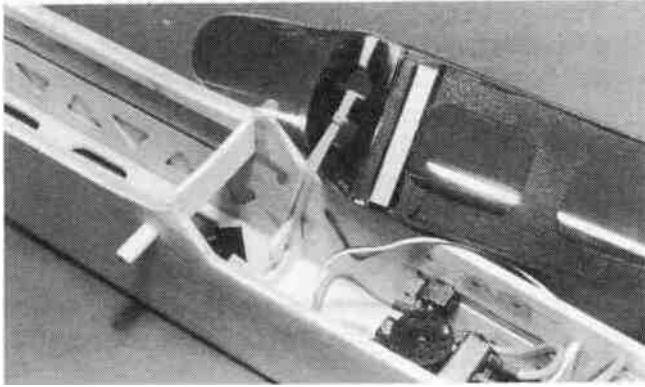

D 4. The canopy is held in place with a rubber band. Loop a medium size rubber band through the cut-out in the canopy back. Thread the rubber band through itself and then hook it on one of the little hooks on former F3. To remove the canopy, pick up on the back until the front is clear of the dowel. To put the canopy back on just do the opposite.

D 5. Install the prop assembly onto the motor shaft. Make sure the set screw is securely tightened against the flat on the shaft and a drop of medium strength thread locker on the set screw is also a good idea.

BALANCE THE MODEL

NOTE: This section is VERY important and must not be omitted! A model that is not properly balanced will be unstable and possibly un-flyable.

D 1. The balance point (CG-Center of Gravity) is shown on the plan, and is located under the spar. This is the balance point at which your model should balance for your first flights. Later, you may wish to shift the balance up to 3/8" **behind** the spar to change the flying characteristics. Moving the CG **forward** of the spar will add some stability but it will **decrease** the overall performance of the sailplane and make it stall easier at slower speeds. Moving the balance **behind** the spar makes the model more agile with a lighter and snappier "feel" and **improves** the sailplane's response to air currents. It also makes the model **less stable** and can cause the sailplane to "tuck under" or dive when its flying speed increases. If you fly the SPECTRA with its CG behind the spar (usually only contest flying), pay close attention and do not let it gain excessive speed. If it does tuck under and you have plenty of altitude, give the plane a little down elevator

and allow it to go on under. When it starts to climb up the back of the "outside loop" its airspeed will drop and you can pull out with some up elevator or roll out with full rudder. If you don't have plenty of altitude, gently pull out with up elevator but **be careful and don't "jerk"** it up or you may over stress the wing.

D 2. With the wing attached to the fuselage, and all parts of the model installed (ready to fly, including batteries and the prop assembly), lift the model by picking it up with a finger on each bottom inner spar. If the tail drops when you lift, the model is "tail heavy" and you must add weight to the nose to balance. If the nose drops, it is "nose heavy" and **you** must add weight to the tail to balance. The model should hang with a **slight** nose down attitude. The first thing to try when balancing the SPECTRA is moving the receiver battery tray. Slide it forward to correct a tail heavy plane and slide **it** backwards to correct a nose heavy plane. If the shifting of the receiver battery alone is not enough you may have to add some lead to either the nose or tail to achieve the proper balance. When you have the plane balanced, glue the receiver battery tray in place with thin CA. **DO NOT ATTEMPT TO FLY WITHOUT FIRST ACHIEVING THE PROPER BALANCE!**

PRE-FLIGHT

CHARGE THE BATTERIES

Follow the battery charging procedures in your radio instruction manual. You should always charge your transmitter and receiver batteries the night before you go flying, and at other times as recommended by the radio manufacturer.

Fully charge your flight battery following the instructions that came with the battery and the charger.

FIND A SAFE PLACE TO FLY

The best place to fly your R/C model is an AMA (Academy of Model Aeronautics) chartered club field. Ask your hobby shop dealer if there is such a club in your area **and** join. Club fields are set up for R/C flying which makes your outing safer and more enjoyable. The AMA can also tell you the name of a club in your area. We recommend that you **join** AMA and a local club so you can have a safe place to fly and also have insurance to cover you in case of a flying accident. (The AMA address is listed on the front cover of this instruction book).

If a club and its flying site are not available, you need to find a large, grassy area at least 6 miles away from any other R/C radio operation and away from houses, buildings and streets. A schoolyard may look inviting but it is usually too close to people, power lines and possible radio interference.

If you are not thoroughly familiar with the operation of R/C models, ask an experienced modeler to check to see that you have the radio installed correctly and that all the control surfaces do what they are supposed to.

RANGE CHECK YOUR RADIO

Wherever you do fly, you need to check the operation of the radio before every time you fly. This means with the transmitter antenna collapsed and the receiver and transmitter on, you should be able to walk at least 100 feet away from the model and still have control. Have someone help you. Have them stand by your model and, while you work the controls, tell you what the various control surfaces are doing. Do this test both with the motor running and without so you can tell if the motor is producing any interference. If it is you may have to add additional capacitors as shown below. If you are using an electronic speed control, follow the manufacturers instructions.

INSTALL THE WINGS

Install the wing on the fuselage using eight (8) #64 rubber bands. If you built a two-piece wing it will help performance slightly if you wrap the top of the center joint with a strip of vinyl tape.

AMA SAFETY CODE

Read and abide by the following Academy of Model Aeronautics Official Safety Code:

GENERAL

1. I will not fly my model aircraft in competition or in the presence of spectators until it has been proven to be airworthy by having been previously successfully flight tested.
2. I will not fly my model aircraft higher than approximately 400 feet within 3 miles of an airport without notifying the

airport operator. I will give right of way to, and avoid flying in the proximity of full scale aircraft. Where necessary an observer shall be utilized to supervise flying to avoid having models fly in the proximity of full scale aircraft.

3. Where established, I will abide by the safety rules for the flying site I use, and I will not willfully and deliberately fly my models in a careless, reckless and/or dangerous manner.

RADIO CONTROL

1. I will have completed a successful radio equipment ground check before the first flight of a new or repaired model.
2. I will not fly my model aircraft in the presence of spectators until I become a qualified flyer, unless assisted by an experienced helper.
3. I will perform my initial turn after takeoff away from the pit, spectator and parking areas, and I will not thereafter perform maneuvers, flights of any sort or landing approaches over a pit, spectator or parking area.

FLYING

First of all, if you are flying with other flyers check to make sure they are not flying or testing on the same frequency as your model.

Try to find an experienced pilot to help you with your first flights. Although the SPECTRA is very easy to fly, an experienced pilot can save you a lot of time and possible aggravation by helping you get your model in the air smoothly.

HAND LAUNCHED TRIM FLIGHTS

It is a good idea to do a couple of trim flights, without the motor running, before each flying session to make sure the plane is still in trim and the radio is working properly. The model will survive a hard landing from 5 feet much better than it will one from several hundred feet. The first few trim flights should be done over a grass field. The longer the grass the better (more cushion).



Turn on the transmitter first and then the receiver and hold the SPECTRA under the wing with the nose pointed slightly down and directly into the wind as shown in the photo. Do not run the motor for these test flights. It is very important that you launch the model with the wings level and the nose pointing at a spot on the ground about 50 feet in front of you. Have a friend stand off to the side of you and tell you whether the nose is pointing up or down. Show your friend the picture above so he will know what to look for. If the SPECTRA is launched with the nose up or launched too hard it will climb a few feet, stall and fall nose first straight down. With the nose pointed down slightly the sailplane will accelerate down until it picks up enough flying speed then level off and glide forward. The plane should be launched with a gentle push forward. With a little practice you will be able to launch it just the right speed so it soars straight ahead in a long and impressive glide path. Adjust the trims on your transmitter to get the plane to fly straight ahead in a smooth glide path. It is important you don't "over-control" the model. Make any control inputs slowly and smoothly rather than moving the transmitter sticks abruptly.

YOUR FIRST FLIGHT

Find a BIG OPEN field for your first flights. The bigger the better as you won't have to worry about where you need to land. Ground based objects (trees, poles, buildings, etc.) seem to attract model airplanes like a magnet. **Again, we would like to recommend you find an experienced pilot to help you with these first flights.**

NOTE: You need to remember that your radio control responds as if you were sitting in the cockpit. When you push the transmitter stick to the right, the rudder moves to the plane's right! This means that when the plane is flying towards you it may seem like the rudder controls are reversed (when you give "right" rudder the plane turns to your left-which is the plane's "right") It is sometimes easier to learn to fly the plane if you always face your body in the direction the plane is flying and look over your shoulder if necessary to watch the model.

Turn on your transmitter and then your receiver and hold the model as you did for the hand launched test flights. Hold it firmly and turn on the throttle to test the motor operation. When satisfied that everything is responding as it should, launch the model straight into the wind **just as you did without the motor running.** It is important that you don't throw the plane **up** or it may stall and hit the ground. If you launch it level or **slightly** down the plane will accelerate and start climbing on its own.

The SPECTRA is designed to climb at about a 30 degree angle without any control inputs. When the plane is trimmed for level gliding flight a 7 cell battery will make it climb very nicely without additional control inputs. If you want to just fly around under power rather than climb, a small amount of down trim will be required to hold the plane level. When the motor is shut off this down trim will have to be taken out or the plane will start to dive.

Don't worry about accomplishing very much on your first flights. Use these flights to get the "feel" of the controls and the SPECTRA'S flying characteristics. For the first few seconds of the flight allow the plane to gently climb straight ahead. Try to keep the plane upwind and just perform some gentle "S" turns (always turning into the wind) until it has reached a comfortable soaring altitude (200' - 300'). Turn the motor off and allow the SPECTRA to soar around, keeping the plane upwind of yourself. When you feel like its getting too low, turn the motor back on and climb back up to altitude. It can be very hard for a beginner to fly a plane straight towards him as he would have to do if the plane were downwind and every mistake takes the plane a little farther downwind. While the SPECTRA is gliding have a helper adjust the trims on your transmitter (a little at a time) until the plane will fly straight and level with the transmitter sticks in their neutral positions.

When you can hear the motor starting to die off and/or the plane does not want to climb anymore it is time to shut off the motor for the last time (especially if you have BEC). It is important to remember that you no longer have enough power to climb out again, so you only get one chance at landing. When it is time to land just continue performing the gentle S-turns upwind and let the plane glide onto the ground. Don't worry about where the plane lands, just miss any trees, etc. If you need to "stretch" a landing you can switch the motor back on but don't expect it to be able to carry you very far. When Nicad batteries start going dead, they really go dead in a hurry. An alternative to allowing the battery to become weak before shutting the motor off for good is to time the motor runs so you can leave enough "Juice" in the battery for a couple of "go arounds" if needed.

Practice flying directly into the wind (upwind of yourself) without letting the plane get off course and then turn and come downwind until the plane is even with you and try it again. When you are comfortable with flying directly into the wind, start letting the plane go behind you (downwind) a little before you start back upwind. Continue this until you can fly

directly towards you from downwind without getting disoriented. At this point you can start to establish a "landing pattern" and bring the sailplane in for a landing from downwind. Landing into the wind enables the plane to be flown as slowly (ground speed) as possible for accurate and damage free landings.

It is probably not a good idea to try and fly around at a low altitude with the motor on during your first flights. This will cause the plane's speed to increase and make the controls more responsive which is just what a beginner does not need.

The SPECTRA will climb to altitude several times on a single charge allowing you to have flights well over ten minutes without finding any "lift". You should be able to get two "full" climbs above 500' on a single charge although there are many factors controlling this.

THERMAL FLYING

Thermal soaring is one of the most intriguing of all aspects of flying and the SPECTRA was designed to excel at thermal soaring even in the hands of a novice. It can be hard for the average person to understand how a plane can fly for hours and gain altitude **without the motor running!**

FACTS ABOUT THERMALS

Thermals are a natural phenomenon that happen outside, by the millions, every single day of the year. Thermals are responsible for many things including forming several types of clouds, creating breezes, and distributing plant seeds and pollen. If you have ever seen a dust devil (which is nothing more than a thermal that has picked up some dust), you have seen a thermal in action. Their swirling action is very similar to that of a tornado's but of course much gentler. Most thermals have updrafts rising in the 200-700 feet per minute range but they have been known to produce updrafts of over 5,000 feet per minute (that's over 50 miles/hour straight up!) These strong thermals can rip a plane apart or carry the plane out of sight before the pilot can get out of the updraft.

Thermals are formed by the uneven heating of the earth and buildings, etc. by the sun. The darker colored surfaces absorb heat faster than the lighter colors which reflect a great deal of the sun's energy back into space. These darker areas (plowed fields, asphalt parking lots, tar roofs, etc.) get warmer than the lighter areas (lakes, grassy fields, forests, etc.). This causes the air above the darker areas to be warmer than the air **over** the lighter areas and the more buoyant warm air rises as

the cooler, denser air forces its way underneath the warmer air. As this warm air is forced upward it contacts the cooler air of the higher altitudes and this larger temperature difference makes the thermal rise quicker. The thermal is gradually cooled by the surrounding cooler air and its strength diminishes. Eventually the thermal stops rising and any moisture contained in the once warm air condenses and forms a puffy cumulus cloud. These clouds, which mark the tops of thermals, are usually between 2000 and 5000 feet high.

TYPICAL THERMAL

Wind causes thermal
to drift downwind

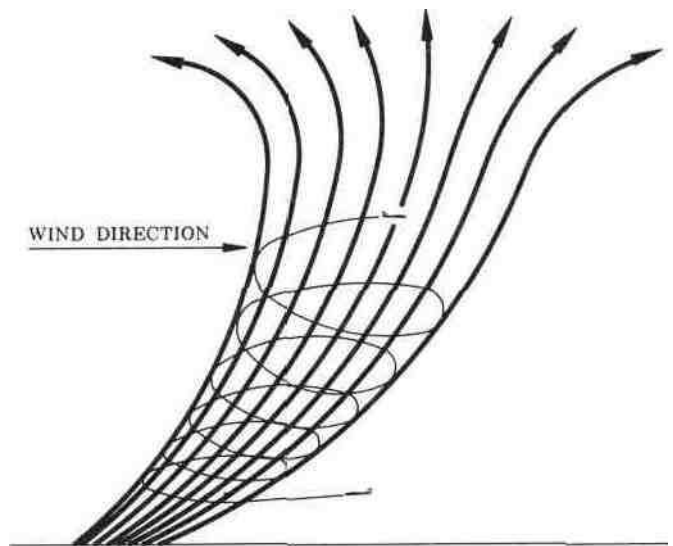

THERMAL SOARING

It takes a lot of concentration to thermal soar effectively. A sailplane can fly along the edge of a thermal and unless the pilot is carefully watching the model he may not realize the opportunity to gain some altitude. Because most thermals are relatively small (a couple hundred feet in diameter or less at 400' altitude.) compared to the rest of the sky, the sailplanes will rarely fly directly into the thermal and start rising. Generally, the sailplane will fly into the edge or near a thermal and the effects the thermal has on the plane may be **almost** unnoticeable. As the sailplane approaches a thermal, the wing tip that reaches the rising air first will be lifted before the opposite wing tip. This causes the plane to "bank" **and** turn away from where we would like the plane to go.

When you are thermal soaring, try to fly as smoothly and straight as possible. Trim the plane to fly in a straight line and **only** touch the controls when you have to. Watch the sailplane carefully and it will tell you what it is encountering.

When the sailplane flies directly into a thermal it will either start rising or stop sinking. Either case is reason enough to start circling (especially in a contest where every second counts). Fly straight ahead until you feel like you are in the strongest lift, **fly a couple of seconds farther** (so your circle will be centered in the strongest lift) and then start circling in a fairly tight but smooth turn. When the sailplane is low the turns have to be tighter to stay in the strongest lift. As the plane gains altitude, the turns can be larger and flatter. The flatter the turn the more efficient the plane is flying, but don't be afraid to really "crank" it into a steep bank when you are low. If you see the plane falling off on one side of the turn, move your circle over into the stronger lift. Thermals move along with the wind so as you circle you will be swept along with it. Be careful when thermaling that you don't get so far downwind you can't make it back to the field to land.

If the sailplane is flying along straight and all of a sudden turns, let the plane continue to bank (you may have to give it some rudder to keep it banking) until it has turned 270 degrees (3/4 of a full circle). Straighten out the bank and fly into whatever turned the plane. If you encounter lift, and you won't every time, start circling just as you did when flying directly into a thermal.

Thermals are generated all day long, but the strongest thermals are produced when the sun is directly overhead. 10:00 am - 2:00 pm seems to be the best time to get those "killer" thermals. Some of these thermals can be very large and you may find it hard to get out of them. If you find yourself getting too high, don't dive the plane to get out of the lift. Sailplanes are very efficient aircraft and they will build up a lot of speed and could "blow up" in the rough air of a thermal. The easiest way to lose altitude is to apply full rudder and full up elevator. This will put the plane into a tight spin that will not over stress the airframe but it will enable it to lose altitude very quickly. This is especially helpful if the sailplane gets sucked into a cloud or it gets too high to see. The twirling action will give the sun a better chance of flashing off of the wing and catching your attention. When you are high enough and want to leave the thermal, add a little down trim to pick up some speed and fly 90 degrees to the direction of the wind. If you are not real high and want to find another thermal, you may want to look upwind of the last thermal. The same source that generated this thermal is probably producing another. Just watch out for "sink" it is often found behind and between thermals.

As you might expect, with all this air rising, there is also air sinking. This air is the sailplane pilot's nightmare that can really make soaring challenging. "Sink" is **usually** not as strong as the thermals in the same area, but it can be very strong. Down drafts of many hundreds of feet per minute are common on a good soaring day. These down drafts can make a sailplane look like it is falling out of the air. Because of this, it is important that you do not let the sailplane get too far downwind.

When encountering sink, immediately turn and fly **90** degrees to the direction of the wind (towards you if possible). Apply a little "down elevator" and pick up some speed to get out of the sink as fast as possible. Every second you stay in the sink is precious altitude lost

SOME IMPORTANT SOARING TIPS

Watch the birds! - Thermals suck up small insects that many birds love to eat. A bunch of swallows flying around in one area may indicate a thermal. Soaring birds (hawks, vultures, eagles etc.) are the best thermal indicators. They not only show you where the thermal is but they also show you where the center is. These "Masters of the sky" will often fly right along with sailplanes.

Know your sailplane! - Learn what your sailplane will and won't do and fly within this envelope. This will allow you to ride thermals downwind while knowing when you have to head back to make your landing safely.

Learn from the wind! - Keep track of which way the wind is blowing. If the wind suddenly shifts, there is some thermal action fairly close to you. The air is probably being either sucked up into a thermal or falling out of some sink. In either case it is often a good idea to fly in the direction the wind is blowing if your sailplane is in the general area. This will take you towards a thermal if there is one or away from the sink, both of which are desirable.

Have a ball! But always stay in control and fly in a safe manner. GOOD LUCK AND GREAT FLYING!

DYNAMIC BRAKE MODIFICATION

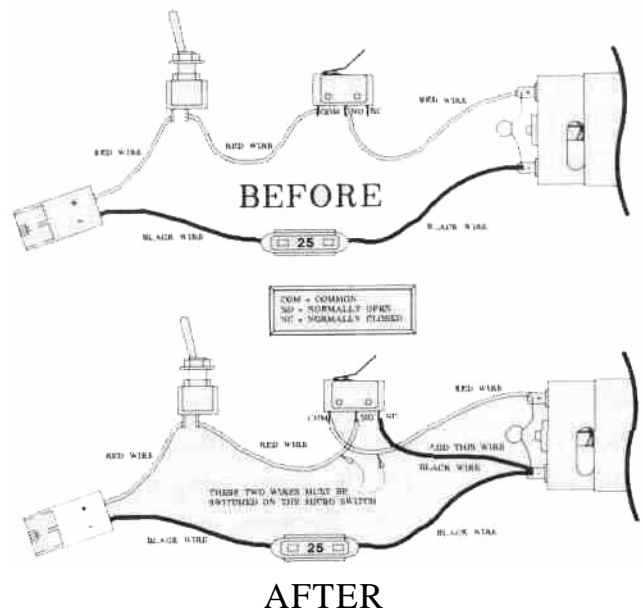

PARTS LIST

PART#	QTY	DESCRIPTION	PART#	QTY	DESCRIPTION
PACKED LOOSE IN KIT			SUB-PACK DC LONG PIECES (SPECA04)		
ALUM010	1	Aluminum wing joiner	SPECF08	1	3/16" x 15" Balsa triangle stock
CANPY045	1	SPECTRA Canopy	SPECF09	2	1/4" Sq. x 11-7/8" Balsa pushrod
SPECD01	1	SPECTRA 6-Color decal	SPRTS02	3	3/16" x 3/8" x 30" Balsa tail frame
SPECF01	2	3/32" DC Fuse side & tripler	SPECF03	2	1/8" x 3/16" x 30" Balsa tail diag.
SPECF15	1	Balsa top nose block	SPRTW13	4	1/8" x 5/16" x 23-1/2" Inner spars
SPECP01	1	Full size rolled plans	SPRTW14	4	1/8" x 5/16" x 15-1/8" Outter spars
SPECP02	1	Instruction book	SUB-PACK DIE-CUT WING RIBS (SPRTA02)		
SPRTW15	2	7/8" x 6-1/4" Balsa wing tip	SPRTW01	1	1/8" Balsa ribs 1A, 1B, 3A & 3B
NYLON87	1	Nylon hinges	SPRTW02	2	1/16" Balsa ribs 2 & 2S
WIRES 10	1	36" Threaded wire	SPRTW03	2	1/16" Balsa ribs 2, 4-10
SUB-PACK COMPLETE MOTOR SYSTEM (MOTORA06)			SPRTW07	2	1/16" Balsa shear webs
CAPACIT1	1	Motor capacitor	SUB-PACK TE, ELEV & SHEETING (SPRTA06)		
HARNESS3	1	Switch harness	SPRTS04	1	3/16" x 23" Balsa tapered elevator
MOTOR002	1	Goldfire motor	SPRTW10	1	7/16" x 24" Balsa shaped LE
ADAPQH01	1	Aluminum hub	SPRTW11	2	1/4" x 24" Balsa tapered inner TE
ADAPQS01	1	Aluminum spinner	SPRTW12	2	1/4" x 24" Balsa tapered outer TE
FUSES20	1	20 Amp fuse	SPRTW17	3	1/16" x 3" x 24" Balsa wing sheet
FUSES25	1	25 Amp fuse	SUB-PACK HARDWARE & SMALL PARTS (SPECM01)		
SCRW037	1	6-32 x 5/8" S.H. cap screw	DOWEL030	2	1/4" x 3-1/2" Hrdwd wing dowel
SCRW038	1	6-32 x 1/4" Set screw	DOWEL035	1	1/8" x 3/4" Hrdwd canopy dowel
SCRW057	1	6-32 x 3/4" S.H. cap screw	FTAP001	2	1/32" Double sided foam tape
WRENCH01	1	1/16" Hex wrench	NYLON03	2	Nylon control horn
WRENCH02	1	7/64" Hex wrench	NYLON17	2	Nylon clevis
PROP001	1	8 x 4 Nylon prop	SCRW001	4	2-56 x 3/8" Machine screw
SUB-PACK DIE-CUT FUSE PARTS (SPECA01)			SCRW024	1	#2 x 3/8" Screw
SPECF02	2	1/16" Balsa front fuse doubler	SCRW056	2	3mm x 10mm Machine screw
SPECF03	1	1/8" Plywood front fuse bottom	SPECF14	2	1/8" x 3/8" x 1" Ply thrtl servo rail
SPECF13	2	1/16" Balsa rear doubler, nose cap	SPECF16	1	1/8" x 2" x 2" Balsa battery tray
SPRTF04	1	3/32" Balsa rear fuse top, bottom	BS60W19	2	1/4" x 3/8" x 2" Basswd servo rail
SUB-PACK DIE-CUT SHEETS (SPECA03)			SPRTW18	2	1/16" x 5/8" x 1-1/8" Ply wing prot.
SPECF05	1	1/8" Ply formers & canopy ends	VLCRSH02	1	3/4" x 1-1/2" Velcro
SPECF06	1	1/8" Balsa canopy base			
SPECF07	1	1/8" Ply formers-F2, F4, F5, F6			
SPRTS01	1	3/16" Balsa tail parts			
SPRTW04	1	1/8" Plywood dihedral brace			
SPRTW05	1	1/6" Plywood wing joiners			
SPRTW06	1	1/32" Plywood polyhedral braces			
SPRTW08	1	1/8" Plywood clamps & gauges			