

# CAP 232

## INSTRUCTION MANUAL



### WARRANTY

Great Planes Model Manufacturing Co. guarantees this kit to be free from defects in both material and workmanship at the date of purchase. This warranty does not cover any component parts damaged by use or modification. **In no case shall Great Planes' liability exceed the original cost of the purchased kit.** Further, Great Planes reserves the right to change or modify this warranty without notice.

In that Great Planes has no control over the final assembly or material used for final assembly, no liability shall be assumed nor accepted for any damage resulting from the use by the user of the final user-assembled product. By the act of using the user-assembled product, the user accepts all resulting liability.

**If the buyers are not prepared to accept the liability associated with the use of this product, they are advised to return this kit immediately in new and unused condition to the place of purchase.**

**READ THROUGH THIS INSTRUCTION MANUAL FIRST. IT CONTAINS IMPORTANT INSTRUCTIONS AND WARNINGS CONCERNING THE ASSEMBLY AND USE OF THIS MODEL.**



P.O. Box 788

Urbana, IL 61801 (217) 398-8970  
www.greatplanes.com

## TABLE OF CONTENTS

<b>SAFETY PRECAUTIONS</b> .....	<b>2</b>
<b>INTRODUCTION</b> .....	<b>2</b>
<b>DECISIONS YOU MUST MAKE</b> .....	<b>3</b>
Engine Selection .....	3
Exhaust System .....	3
Servo Selection .....	3
<b>PREPARATIONS</b> .....	<b>3</b>
Required Accessories .....	3
Building Supplies & Tools .....	4
Optional Supplies & Tools .....	4
Building Notes .....	5
Types of Wood.....	5
Common Abbreviations .....	5
Metric Conversions .....	5
Get Ready to Build .....	5
<b>DIE-CUT PATTERNS</b> .....	<b>6 &amp; 7</b>
<b>BUILD THE TAIL SURFACES</b> .....	<b>8</b>
Build the Stab.....	8
Elevator Building Sequence .....	9
Fin Building Sequence .....	9
Rudder Building Sequence .....	9
Hinge the Tail Surfaces .....	9
Finish the Tail Surfaces .....	10
<b>BUILD THE WING</b> .....	<b>11</b>
Make the Wing Sheets .....	11
Build the Wing Panels .....	12
Join the Wing Panels.....	15
Sheet the Wing.....	16
Build the Ailerons .....	16
<b>BUILD THE FUSELAGE</b> .....	<b>18</b>
Assemble the Fuselage Former & Sides.....	18
Assemble the Fuselage.....	20
Mount the Wing to the Fuselage .....	21
Build the Front Fuselage Deck .....	25
Mount the Stabilizer to the Fuselage.....	26
Build the Turtledeck .....	27
Mount the Engine .....	29
Install the Battery & Tank .....	30
Install the Servos and Make the Pushrods.....	31
Add the Forward & Aft Wing Fairings .....	33
Assemble the Wheel Pants .....	34
Assemble the Cowl .....	36
Prepare the Model for Covering .....	37
<b>COVER THE MODEL</b> .....	<b>37</b>
Covering Technique.....	37
Suggested Covering Sequence .....	37
<b>BALANCE THE MODEL Laterally</b> .....	<b>38</b>
<b>PAINTING</b> .....	<b>38</b>
<b>FINAL HOOK-UPS AND CHECKS</b> .....	<b>38</b>
Join the Control Surfaces.....	38
Install the Hardware .....	39
Attach the Canopy.....	39
Set the Control Throws.....	40
Balance the Model .....	40
<b>PREFLIGHT</b> .....	<b>41</b>
Charge the Batteries .....	41
Balance the Propeller.....	41

Find a Safe Place to Fly .....	41
Ground Check the Model .....	41
Range Check the Radio .....	42
Engine Safety Precautions.....	42
AMA Safety Code.....	42
<b>FLYING</b> .....	<b>43</b>
Takeoff.....	43
Flight .....	43
Landing .....	43
<b>TWO VIEW DRAWING</b> .....	<b>BACK COVER</b>

### PROTECT YOUR MODEL, YOURSELF & OTHERS...FOLLOW THIS IMPORTANT SAFETY PRECAUTION

Your CAP 232 is not a toy, but rather a sophisticated, working model that functions very much like an actual airplane. Because of its realistic performance, the CAP, if not assembled and operated correctly, could possibly cause injury to yourself or spectators and damage property.

**If this is your first low wing sport model we recommend that you get help from an experienced, knowledgeable modeler with your first flights.** You'll learn faster and avoid risking your model before you're truly ready to solo. Your local hobby shop has information about flying clubs in your area whose membership includes qualified instructors.

You may also contact the national Academy of Model Aeronautics (AMA), which has more than 2,500 chartered clubs across the country.



#### **Academy of Model Aeronautics**

5151 East Memorial Drive  
Muncie, IN 47302-9252  
Tele. (800) 435-9262  
Fax (765) 741-0057

## INTRODUCTION

Congratulations and thank you for purchasing the Great Planes CAP 232. The CAP is a rather "square" airplane with well-defined lines. Coincidentally, this makes it exceptionally easy to build and cover—especially for a semi-scale sport model. Framing the model is very straightforward, as most of the structure features interlocking balsa and lite-ply. The turtledeck sheeting may look a little intimidating but in actuality it is quite easy to apply if you follow the instructions.

Flying the CAP 232 is a rewarding experience—as it should be for such an aerobatic model! It doesn't take much elevator or aileron throw to put the CAP through its paces. When you have a feel for your CAP 232, the throws can be increased to high rates (illustrated in the instructions) to

really showcase the aerobatic potential. The CAP performs surprisingly well on a ball bearing Schneurler ported .40, but seasoned experts will surely want to get the most out of the CAP by bolting on a .46 2-stroke or a .70 4-stroke.

We hope you enjoy building and flying your Great Planes CAP 232 as much as we did the prototypes.

**Please inspect all parts carefully before starting to build! If any parts are missing, broken or defective, or if you have any questions about building or flying this airplane, please call us at (217) 398-8970. If you are calling for replacement parts, please reference the part numbers and the kit identification number (stamped on the end of the carton) and have them ready when calling.**

Product info – [www.greatplanes.com](http://www.greatplanes.com)  
E-mail – [productsupport@greatplanes.com](mailto:productsupport@greatplanes.com)

## PRECAUTIONS

1. Build the plane according to the plans and instructions. Do not alter or modify the model, as doing so may result in an unsafe or unflyable model. In a few cases the plans and instructions may differ slightly from the photos. In those instances the plans and written instructions are correct.
2. Take time to build straight, true and strong.
3. Use an R/C radio system that is in first-class condition, and a correctly-sized engine and components (fuel tank, wheels, etc.) throughout your building process.
4. You must properly install all components so that the model operates properly on the ground and in the air.
5. You must check the operation of the model before **every** flight to ensure that all equipment is operating, and that the model has remained structurally sound. Be sure to check nylon clevises or other connectors often and replace them if they show signs of wear or fatigue.
6. If you are not already an experienced R/C pilot you must fly the model only with the help of a competent, well experienced R/C pilot.

**NOTE:** We, as the kit manufacturer, provide you with a top quality kit and great instructions, but ultimately the quality of your finished model depends on how **you** build it; therefore, we cannot in any way guarantee the performance of your completed model, and no representations are expressed or implied as to the performance or safety of your completed model.

**Remember: Take your time and follow directions to end up with a well-built model that is straight and true.**

## DECISIONS YOU MUST MAKE

### Engine Selection

There are several engines that will work well in your CAP 232, but for unlimited performance we recommend a *hot* 2-stroke such as an O.S.® .46FX or SuperTigre™ GS-45. If you prefer a 4-stroke, an O.S. .70 Surpass™ is the ticket. Your choice of 2-stroke or 4-stroke will determine the location of the throttle servo and throttle pushrod exit on the firewall, so plan ahead.

### Exhaust System

If you choose to use a 2-stroke engine, you will need an in-cowl muffler for the best appearance. On our prototype CAP 232 with the O.S. .46FX we used the Slimline #3218 Pitts Muffler (SLIG2218) without the exhaust extension kit. If you prefer to use an exhaust extension kit, you can always purchase #8012 (SLIG5012) for this exhaust. On our prototype CAP 232 with the O.S. 70 Surpass, we used the O.S. short flex pipe (OSMG2684) and the included muffler to make the exhaust exit in the scale location.

### Servo Selection

During our extensive testing of the CAP 232, we found that the CAP performs very well with standard Futaba® S3003 servos on all surfaces. However, for all-out 3D aerobatics, the seasoned expert will want to consider high performance servos such as the Futaba 9001 for elevator and rudder. The additional torque, speed and centering capabilities of these servos will provide crisper performance in everything from slow rolls to hammerheads, torque rolls, knife edge loops and beyond.

## PREPARATIONS

### Required Accessories

*Items in parentheses (OSMG2691) are suggested part numbers recognized by distributors and hobby shops and are listed for your ordering convenience. **GPM** is the Great Planes brand, **TOP** is the Top Flite® brand, and **HCA** is the Hobbico® brand.*

- 4 Channel Radio with 4 Servos
- Engine - See **Engine Selection** above
- Muffler - See **Exhaust System** above
- Spare Glow Plugs (O.S. #8 for most 2-stroke engines, OSMG2691)
- Propeller (Top Flite® Power Point™) we found that a 11x4 on the O.S. .46FX and the 13x6 on the O.S. .70 Surpass worked the best.
- Top Flite Super MonoKote® covering (Approximately 2 rolls); See **Covering** (page 37)

- Fuelproof paint; See **Painting** (page xxxx)
- Medium Fuel Tubing (GPMQ4131, 3')
- 1/4" Latex Foam Rubber Padding (HCAQ1000)
- 1/16" Foam Wing Seating Tape (GPMQ4422)
- 10 oz. Fuel Tank (GPMQ4104)
- (2) 2-1/2" Wheels (GPMQ4223)
- (1) 3/16" Wheel Collar (GPMQ4308)
- (2) 3/32" Wheel Collars (GPMQ4303)
- 2-1/2" Spinner (GPMQ4517 – red)
- Pilot (Williams Bros. 1/5 Scale Sportsman Pilot used in prototype, WBRQ2626)
- Fueling System (Great Planes Top Fueler,™ GPMQ4160)
- Pacer Formula 560 Canopy Glue
- 1" Tail wheel (GPMQ4241)

## Building Supplies and Tools

These are the building tools, glue, etc. that we recommend and mention in the manual. *We recommended Great Planes Pro™ CA and Epoxy*

- 2 oz. Thin CA (GPMR6003)
- 2 oz. Medium CA+ (GPMR6009)
- CA Accelerator (GPMR6035)
- 30-Minute Pro Epoxy (GPMR6047)
- Building Square (HCAR0480)
- Plan Protector (GPMR6167)
- #1 Hobby Knife Handle (HCAR0105)
- #11 Blades (HCAR0311, 100 qty.)
- Razor Saw
- Small T-pins (HCAR5100)
- Medium T-pins (HCAR5150)
- Masking Tape
- Electric Power Drill
- 1/4-20 Tap (GPMR8105, drill bit included)
- Drill Bits: 1/16", 3/32", 7/64", 1/8", 5/32", #18 or 11/64", 3/16", #10 or 13/64" (unless purchased with 1/4-20 Tap listed above), 7/32", 1/4", 17/64"
- Pliers
- Monofilament String for aligning wing and stabilizer
- Screwdrivers (Phillips and Flat Blade)
- HobbyLite™ Balsa Filler (HCAR3401)
- Sealing Iron (TOPR2100)
- Bar Sander or Sanding Block and Sandpaper (coarse, medium, fine grit)
- Microballoons

**Sandpaper.** Great Planes **Easy-Touch Bar Sanders** are made from lightweight, rigid, extruded aluminum and can be found at most hobby shops.



They are available in three sizes—5-1/2" (GPMR6169) and 11" (GPMR6170) for most general purpose sanding and 22" (GPMR6172) for long surfaces such as wing leading edges. The **Easy-Touch Adhesive-Backed Sandpaper** comes in 2" x 12' rolls of 80-grit (GPMR6180), 150-grit (GPMR6183), 220-grit (GPMR6185) and an assortment pack of 5-1/2" long strips (GPMR6189) for the short Bar Sander. The adhesive backed sandpaper is easy to apply and remove from your sanding bar when it's time for replacement.

This setup is all that is required for almost any sanding task. Custom sanders can be made from balsa or hardwood blocks and sticks for sanding difficult to reach spots. We also keep some #320-grit wet-or-dry sandpaper for finish sanding just before covering.

## Optional Supplies and Tools

- 1 oz. Thick CA- (GPMR6014)
- 6-Minute Pro Epoxy (GPMR6045)
- CA Applicator Tips (HCAR3780)
- Epoxy Brushes (GPMR8060)
- Epoxy Mixing Sticks (GPMR8055, qty. 50)
- CA Debonder (GPMR6039)
- Hot Sock (TOPR2175)
- Trim Seal Tool (TOPR2200)
- Heat Gun (TOPR2000)
- Single Edge Razor Blades (HCAR0312, 100 qty.)
- Razor Plane (MASR1510)
- Straightedge (Fourmost Non Slip, FORR2149)
- 1/8" Brass Tube, see page 17, step 10
- 5/32" Brass Tube, see page 33, step 15
- Denatured or Isopropyl Alcohol (for epoxy clean-up)
- Dremel MultiPro™ or similar w/Sanding Drum, Cutting Burr, Cut-off Wheel
- Kyosho® Curved Scissors for trimming Cowl, Wheel Pants and Canopy (KYOR1010)



In our busy work shop we use the Great Planes **Easy-Touch™ Bar Sanders** equipped with Great Planes #80, #150 and #220-grit **Easy-Touch Adhesive-Backed**

## Building Notes

There are two types of screws used in this kit:

**Sheet metal screws** are designated by a number and a length.

For example #4 x 3/4"

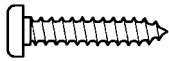

**Machine screws** are designated by a number, threads per inch and a length.

For example 4-40 x 3/4"



When you see the term "**test fit**" in the instructions, it means you should first position the part on the assembly **without using any glue**, then slightly modify the part as necessary for the best fit.

Whenever just "**epoxy**" is specified you may use **either** 30-minute epoxy **or** 6-minute epoxy. When 30-minute epoxy is **specified** it is **highly recommended** that you use only 30-minute (or slower) epoxy because you will need either the working time and/or the additional strength.

Several times during construction we refer to the "top" or "bottom" of the model or a part of the model. For example, during wing construction we tell you to "glue the top main spar" or "trim the bottom of the former." It is understood that the "top" or "bottom" of the model is as it would be when the airplane is right side up and will be referred to as the "top" even if the model is being worked on upside down, *i.e.* the "top" main spar is always the "top" main spar even when the wing is being built upside down.

## Types of Wood

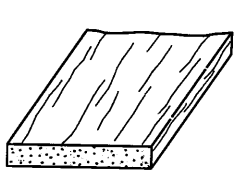

**Balsa**

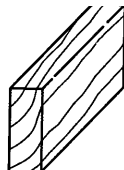

**Basswood**

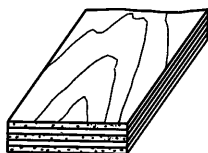

**Plywood**

## Common Abbreviations

Elev = Elevator

LE = Leading Edge (front)

Ply = Plywood

TE = Trailing Edge (rear)

Fuse = Fuselage

LG = Landing Gear

Stab = Stabilizer

" = Inches

## Metric Conversions

1" = 25.4mm (conversion factor)

1/64" = .4mm

1/32" = .8mm

1/16" = 1.6mm

3/32" = 2.4mm

1/8" = 3.2mm

5/32" = 4mm

3/16" = 4.8mm

1/4" = 6.4mm

3/8" = 9.5mm

1/2" = 12.7mm

5/8" = 15.9mm

3/4" = 19mm

1" = 25.4mm

2" = 50.8mm

3" = 76.2mm

6" = 152.4mm

12" = 304.8mm

15" = 381mm

18" = 457.2mm

21" = 533.4mm

24" = 609.6mm

30" = 762mm

36" = 914.4mm

## Get Ready to Build

1. Unroll the plan sheets. Reroll the plans inside out to make them lie flat.

2. Remove all parts from the box. As you do, determine the name of each part by comparing it with the plan and the parts list included with this kit. Using a felt-tip or ballpoint pen, lightly write the part **name** or **size** on each piece to avoid confusion later. Use the die-cut patterns shown on pages 6 and 7 to identify the die-cut parts and mark them **before** removing them from the sheet. **Save all scraps.** If any of the die-cut parts are difficult to punch out, do not force them! Instead, cut around the parts with a hobby knife. After punching out the die-cut parts, use your bar sander or sanding block to **lightly** sand the edges to remove any die-cutting irregularities or slivers.

3. As you identify and mark the parts, separate them into groups, such as **fuse** (fuselage), **wing**, **fin**, **stab** (stabilizer) and **hardware**.

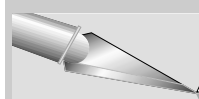

**EXPERT TIP**

Zipper-top food storage bags are handy for storing your parts as you sort, identify and separate them into sub-assemblies.

# DIE-CUT PATTERNS

CAP4F01

2 REQ.

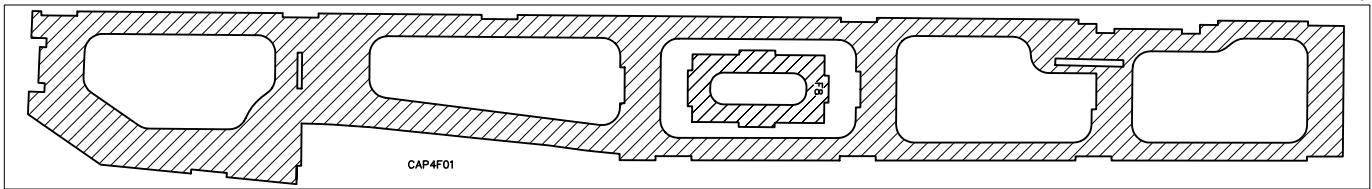

1/8" X 5-1/8" X 38" PLY

CAP4F03

TANK HATCH

1 REQ.

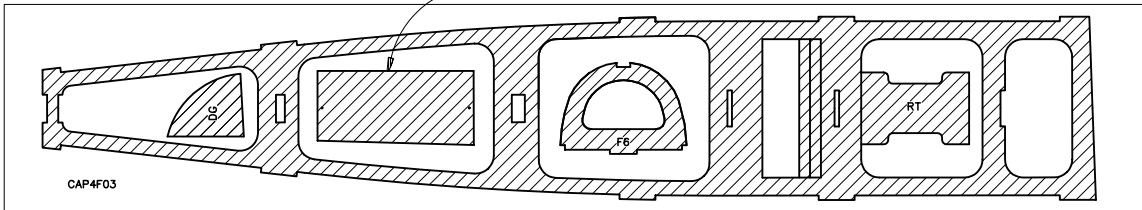

1/8" X 5-3/4" X 31-3/4" PLY

CAP4F04

FORMER F-10

LANDING GEAR BASE

1 REQ.

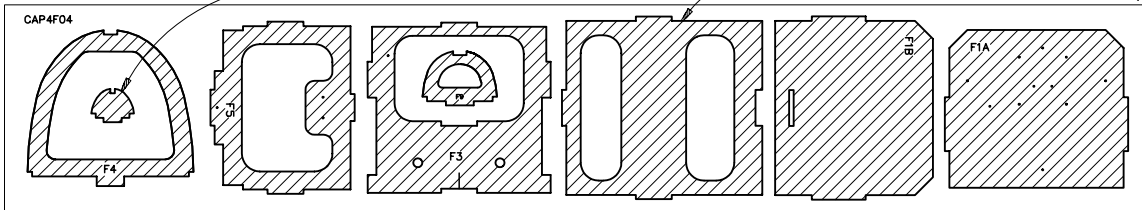

1/8" X 5-3/4" X 31-3/4" PLY

CAP4F05

BOLT PLATE

WHEEL PANT MOUNT

FUSELAGE DOUBLER

BOLT PLATE

1 REQ.

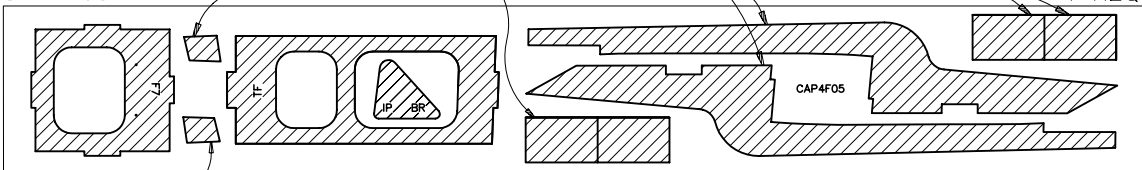

WHEEL PANT MOUNT

1/8" X 4-5/8" X 31-3/4" PLY

CAP4F02

FORMER F-3 DOUBLER

1 REQ.

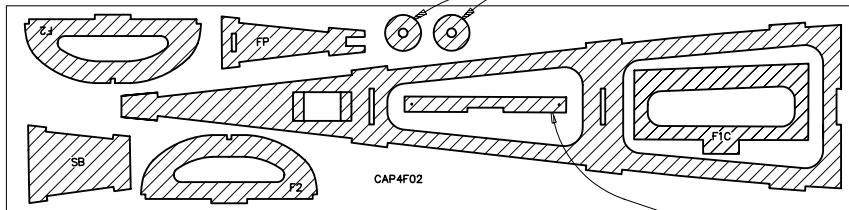

1/8" X 5-3/4" X 23-3/4" PLY

TANK TRAY RETAINER

# DIE-CUT PATTERNS

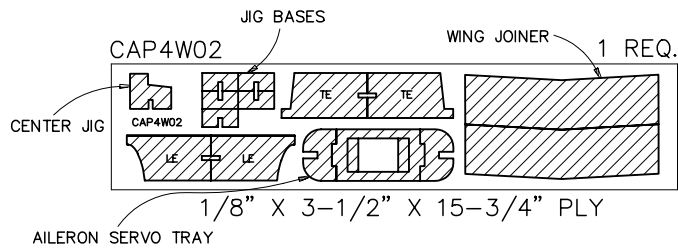
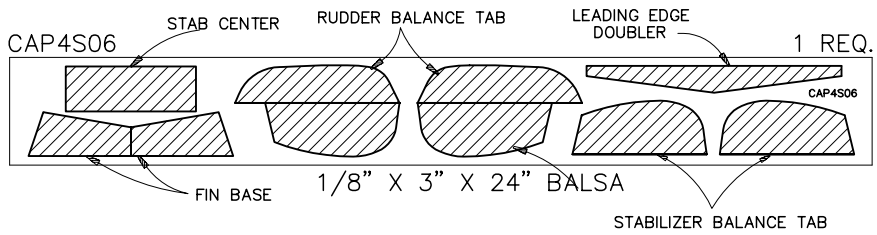
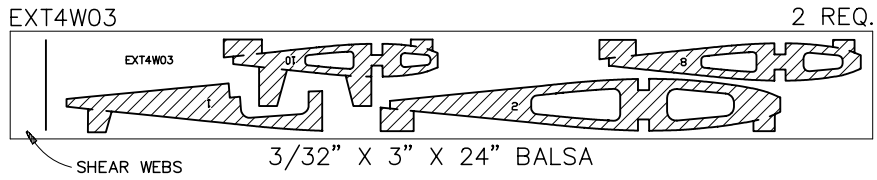
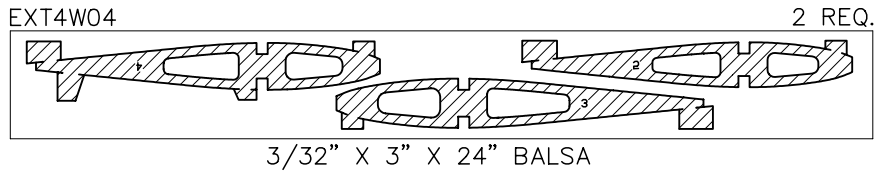
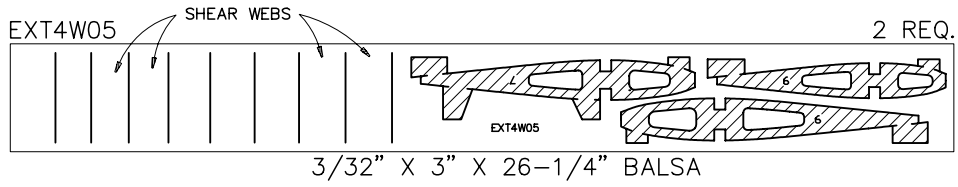

## BUILD THE TAIL SURFACES

### Build the Stab

- ❑ 1. Cover the stab portion of the plan with wax paper or Plan Protector. Pin the die-cut 1/8" balsa stab **LE doubler** in position over the plan. Glue the die-cut 1/8" balsa **stab center** to the LE doubler with medium CA.

**Note:** Refrain from using excessive accelerator. Even hours after it's sprayed on, residual accelerator can prematurely and unexpectedly cure the CA you use later on nearby glue joints. Unless you must handle or remove the part from your building board right away, we recommend using no accelerator at all.

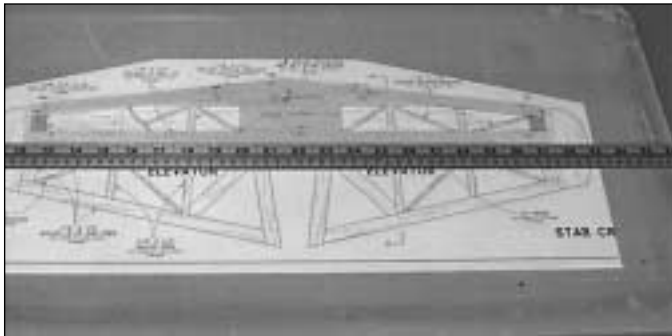

- ❑ 2. Using two of the 1/8" x 1/2" x 24" balsa sticks, cut and fit the stab LE, TE, and tips.

**Hint:** Use a straightedge as a guide to make sure the stab TE is straight before pinning in place. Glue the stab LE's, TE, and tips in place with thin CA.

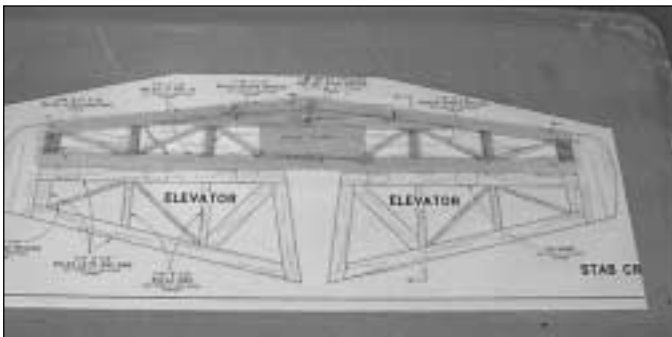

- ❑ 3. From the 1/8" x 1/4" x 24" balsa stick, fit and glue the four cross braces in place. Do the same with a 1/8" x 1/8" x 30" balsa stick to finish the remaining cross bracing.

- ❑ 4. Use your bar sander or a large sanding block and 220-grit sandpaper to sand the entire top and bottom surface of the stab framework until it is flat and even. **Be careful** while sanding so you do not over-thin any one particular area of the stab or gouge the stab cross braces by snagging the sandpaper on them.

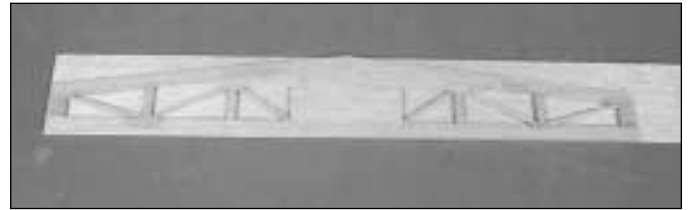

- ❑ 5. Using medium CA, glue one 1/16" x 3" x 24" balsa sheet to one side of the stab framework, aligning the sheeting parallel to the TE of the stab. Give the CA ample time to cure before lifting the assembly off the work bench.

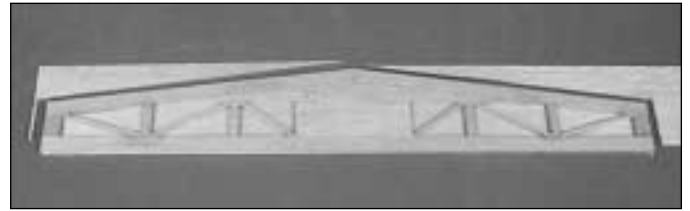

- ❑ 6. Place the sheeted side of the stab on your bench and trim the sheeting around the outer edges of the framework.

- ❑ 7. Repeat steps 5 and 6 to sheet the other side of the stab.

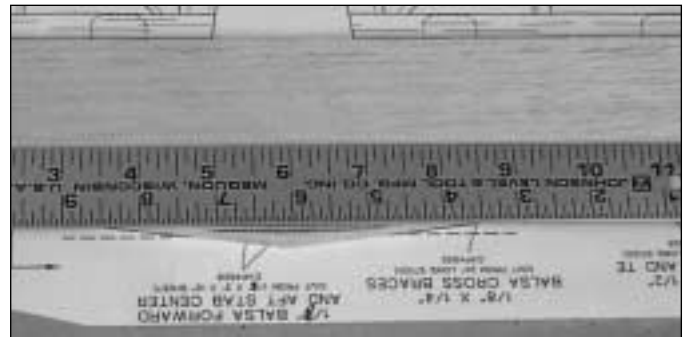

- ❑ 8. Place the sheeted stab back in place over the plan and, using the dotted lines as a reference, draw a line on the stab. Trim the leading edge of the stab on the line you just drew.

*There, that was kind of fun wasn't it? Let's continue to build the elevators, fin, and rudder.*

- ❑ 9. Make two laminated **elevator balance tabs** from the four 1/8" die-cut balsa pieces. Make one **rudder balance tab** from the two die-cut pieces.

**Note:** Do not glue the elevator or rudder balance tabs in place until the leading edges are beveled.

- ❑ 10. Build the elevators, fin and rudder from the 1/4" thick balsa sticks (unlike the 1/8" sticks you used for the stab). Recommended building sequences follow.



## Elevator Building Sequence

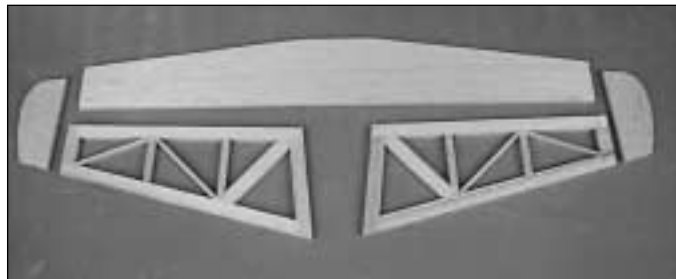

- A. 1/4" x 1/2" LE pin in place
- B. 1/4" x 1/2" Root rib pin and glue
- C. 1/4" x 1/2" elevator tip rib fit and glue
- D. 1/4" x 1/2" TE fit and glue
- E. 1/4" x 1/4" ribs fit and glue
- F. 1/8" x 1/4" diagonal ribs fit and glue
- G. 1/4" x 1/2" diagonal rib fit and glue
- H. Remove the elevator from the plan and inspect all the glue joints. Add CA where necessary.
- I. Sand flat and smooth with bar sander and 220-grit sandpaper. **Note:** Do not glue the laminated balance tab in position until *after* you bevel the leading edge of the elevator as instructed on page 11. This will make it easier to sand the bevel.
- J. Build the other elevator the same as the first.

## Fin Building Sequence

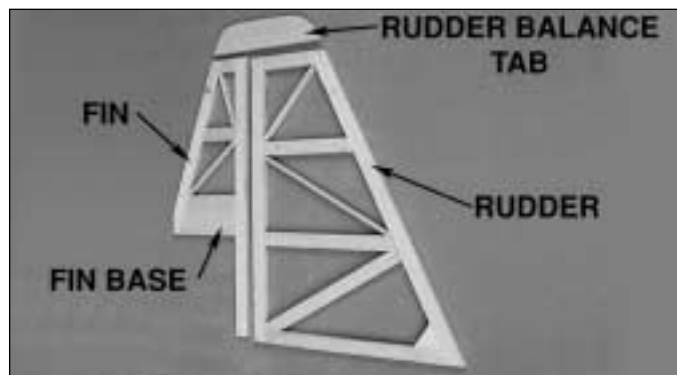

- A. Laminate the two die-cut 1/8" balsa **Fin Bases** together and pin them in place.
- B. 1/4" x 1/2" TE
- C. 1/4" x 1/2" Fin tip
- D. 1/4" x 1/2" LE (cut taper so it fits against F-9 as shown on the plan)
- E. 1/4" x 1/2" center rib
- F. 1/4" x 1/8" diagonal ribs
- G. Remove the fin from your building board and inspect all the glue joints. Add CA where necessary. Use your bar sander to sand the top of the leading and trailing edges even with the tip of the fin. Sand the bottom of the leading edge even with the base. Sand the entire fin flat and smooth with your bar sander and 220-grit sandpaper.

## Rudder Building Sequence

- A. 1/4" x 1/2" LE
- B. 1/4" x 1/2" Rudder bottom
- C. 1/4" x 1/2" TE
- D. Two 1/4" x 1/2" ribs
- E. One 1/4" x 1/2" diagonal rib
- F. Two 1/8" x 1/4" diagonal ribs
- G. Remove the rudder from your building board and sand the top, the LE and TE so they are flush.
  - Note:** Do not glue the laminated balance tab in position until *after* you bevel the leading edge of the rudder as instructed on page 11. This will make it easier to sand the bevel.
- H. Inspect all the glue joints. Add CA where necessary.

## Hinge the Tail Surfaces

- 1. Place the stab over its location on the plan and *lightly* mark the hinge locations on the trailing edge with a ball point pen. Mark the hinge locations on the elevators in the same manner.



### HOW TO MARK THE HINGE SLOTS

It's important that the hinge slots are **centered** and **parallel** to the part you are hinging. The best way to start is by accurately marking the hinge slots. We'll start with the stabilizer.



- A. Lay the stabilizer and a ballpoint pen on a flat surface. Mark a "test line" on the trailing edge of the stab, away from the hinge locations you marked earlier.

**B.** Flip the stab over and mark another line in the same location as the first. If you see only one line, then it is on center. Proceed and mark the hinge slots at each hinge location. If you see two lines you will have to adjust the height of the stab until you can mark only one centerline.

**C.** Use playing cards or business cards to adjust the height of the stabilizer until you can mark the centerline. Mark the hinge slots at each hinge location.

**D.** Use the same technique to mark the centerline along the **entire length** of both elevators.

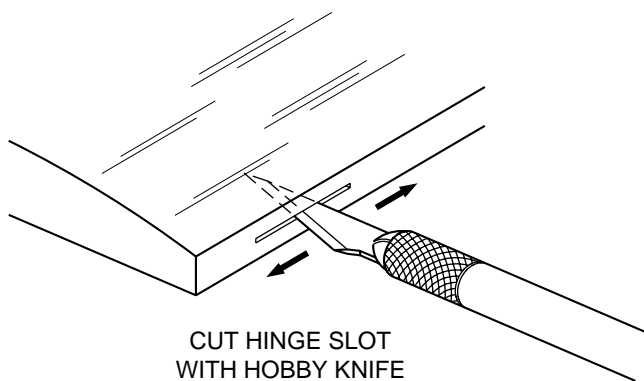

CUT HINGE SLOT  
WITH HOBBY KNIFE  
AND #11 BLADE

3. Cut the hinge slots in the elevator and stabilizer using a #11 blade. Begin by **carefully** cutting a very shallow slit at the hinge location to accurately establish the hinge slot. Make three or four more cuts going a little deeper each time. As you cut, slide the knife from side to side until the slot has reached the proper depth and width for the hinge.

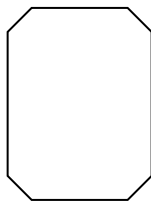

4. Cut 3/4" x 1" hinges for the elevators and rudder from the supplied 2" x 9" **hinge material**, then snip off the corners. **Temporarily** join the elevators to the stab with the hinges adjusting any hinge slots if necessary so they all align. **Do not glue in the hinges until you are instructed to do so.**

5. Return to step 1 and use the same procedures to hinge the rudder and fin.

## Finish the Tail Surfaces

1. Shape the leading edge of the elevators to a "V" as shown on the plan.



### HOW TO BEVEL THE LEADING EDGES



**A.** Place the leading edge of one of the elevators on your work surface and use your ballpoint pen to mark a "bevel to" line on both sides about 3/32" high.

**Note:** You will probably have to adjust the height of the elevator with card stock (as you did while marking the hinge slots) so your "bevel to" line is not too high – making too sharp of a "V."



**B.** Using the "bevel to" lines and the centerline as a guide, make the "V" on the leading edge of the elevators with a razor plane or your bar sander and 150-grit sandpaper.

2. Use the same procedure to bevel the leading edge of the rudder.

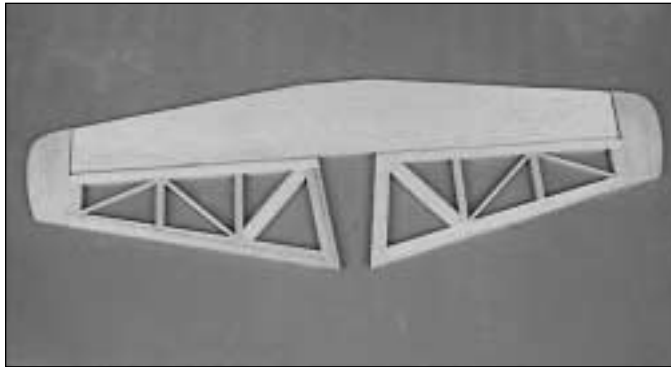
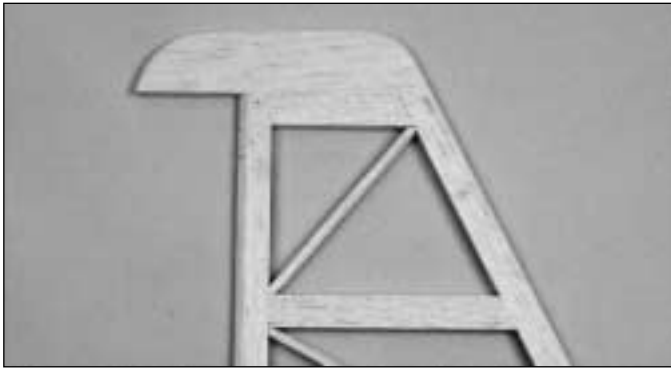

❑ 3. Use the plan to make sure the balance tabs are properly aligned. Then, using medium CA, glue the balance tabs to both of the elevators and the rudder.

❑ 4. Use your bar sander and 150-grit sandpaper to round the tail surfaces as shown on the fuse plan.

*That's about it for the tail surfaces. They're a little more work than sheet surfaces but they are much lighter, just about as strong, and are a nice piece of craftsmanship. Clean off your work bench and get ready for the wing!*

## BUILD THE WING

### Make the Wing Sheets

*Now while you have a nice clean work bench, let's start the wing by making the sheeting.*

❑❑ 1. Glue two 3/32" x 3" x 30" balsa sheets together to make one 6" wide sheet for the top and bottom **leading edge wing sheeting** for **one** wing half.



### HOW TO MAKE WING SHEETS

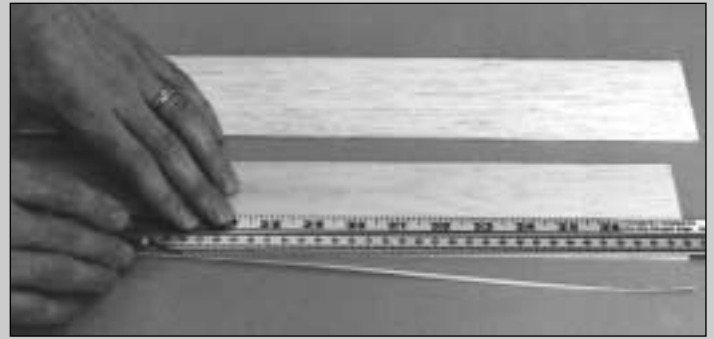

A. Use a metal straightedge as a guide to trim one edge of both sheets.



B. Use masking tape to tightly tape the two sheets together joining the trimmed edges.



C. Turn the sheet over and place weights on top of the sheet to hold it flat. Apply thin CA sparingly to the seam between the two pieces, quickly wiping away excess CA with a paper towel as you proceed.

D. Turn the sheet over and remove the masking tape, then apply thin CA to the seam the same way you did for the other side.

E. Sand the sheet flat and smooth with your bar sander and 150-grit sandpaper.

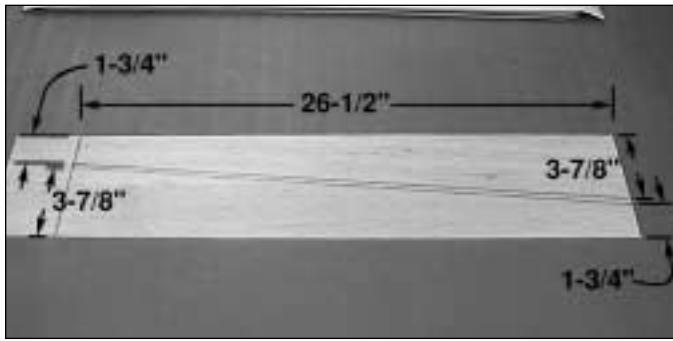

- ❑ 2. Cut the sheet as shown in the photo to make a top and a bottom LE wing sheet.
- ❑ 3. Repeat steps 1 and 2 to make the two leading edge wing sheets for the other wing half.

### Build the Wing Panels

We'll start by building the **right** wing panel upside down over the **left** wing panel plan so your progress matches the photos.

**Note:** Due to the decreasing thickness of the wing towards the tip, the top **main spar** is **not pinned** directly to the building board. Instead, the **ribs** are **securely pinned** to the building board. You must follow the instructions closely on where to insert the T-pins in the ribs so you do not conceal them under the sheeting, making it very difficult to remove the wing from the building board.

TWO WARPED SPARS INSTALLED  
THIS WAY WILL RESULT IN A  
STRAIGHT WING



TWO WARPED SPARS INSTALLED  
THIS WAY WILL RESULT IN A  
WARPED WING

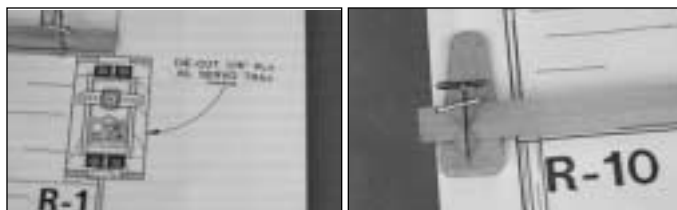

- ❑ 1. Using two large T-pins, cross pin the root end of a 5/16" x 5/16" x 30" basswood main spar over its location on the plan so it lines up with the wing centerline. This is the

**top spar.** Cross pin the tip of the spar to the plan with a piece of 3/32" leftover balsa under the spar past the location of rib R-10.

- ❑ 2. Place (do not glue) the die-cut 3/32" balsa **wing ribs R-2 through R-10** on the top spar over their locations on the plan. **Note:** The **short** jig tabs on **every** rib, should be contacting the plan.

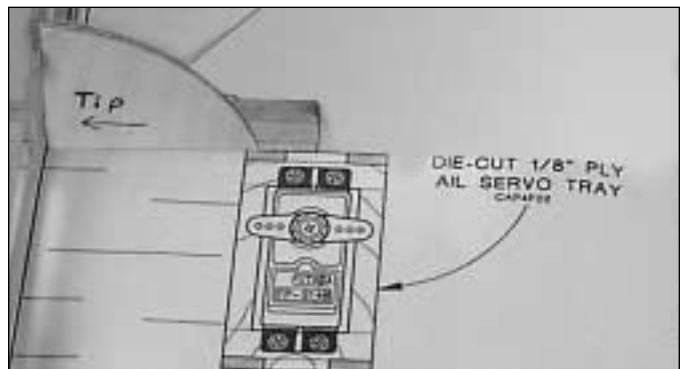
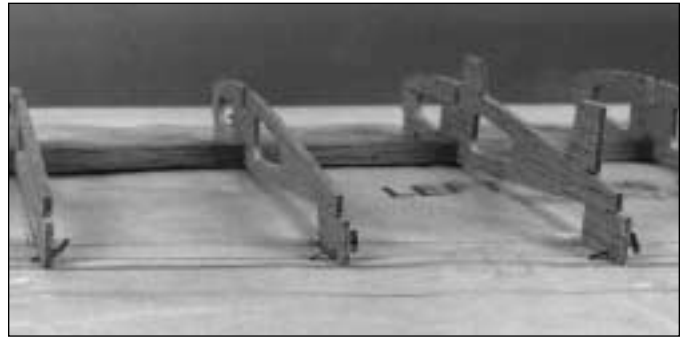

- ❑ 3. Using the dihedral gauge to set rib R-2 at the proper angle, pin the **jig tabs** in place with small T-pins. Again using the dihedral gauge, pin ribs **R-2 through R-10** to your building board over their location on the plan.

**Note:** Insert the T-pins at an angle from the rear, so they can be removed after the trailing edge and bottom sheeting are glued in position.

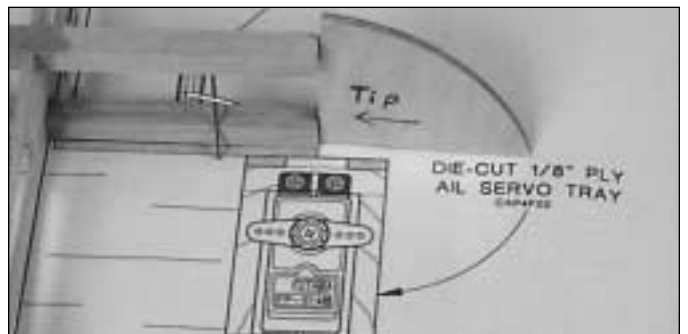

- ❑ 4. Place a 5/16" x 5/16" x 30" spar in the notches of the ribs, using the dihedral gauge to locate **this bottom spar.**



5. Glue the main spars to the ribs with thin CA. As you glue each rib to the spars, simultaneously *pull* the top spar up into the rib and *push* the bottom spar down into the rib to make sure the spars are fully seated in the notches. Make sure all the jig tabs are contacting the work surface.

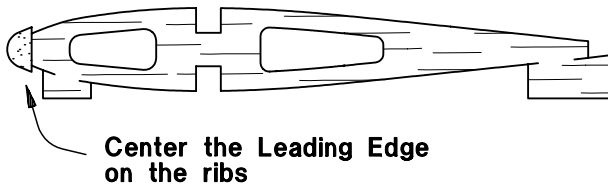

6. Lightly run a sanding bar across the front of the ribs to check alignment. Position the **shaped leading edge (LE)** on the front of the ribs. The LE should be centered on all the ribs and the root end should extend past rib R-2 by about 1/16". Make sure all the jig tabs are contacting the work surface. Use thin CA to glue the LE to the front of the ribs.

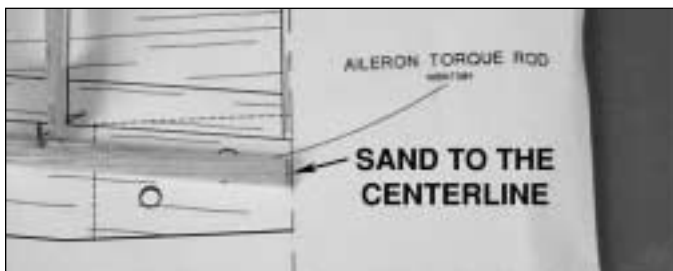

7. Place the 30" balsa **shaped trailing edge (TE)** against the rear of the rib tabs and flat on the work bench.

Mark the root end so that it lines up with the centerline of the wing. Take the TE off your work bench and sand the TE to the mark you made.

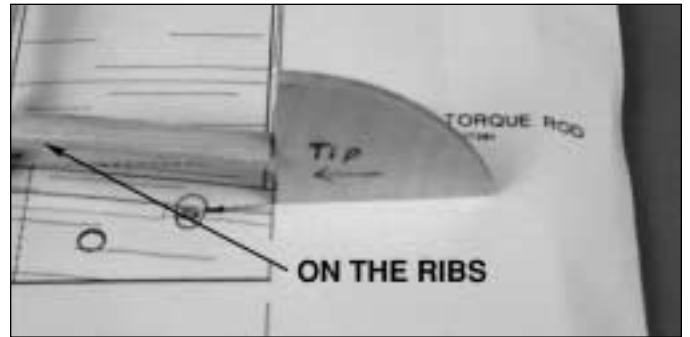

8. Using the dihedral gauge to correctly position the TE, use thin CA to glue the trailing edge (TE) to the ends of the ribs.



9. Starting at ribs R-8 & R-7, test fit the die-cut 3/32" cross grain balsa **shear webs** to the **front** of the spars. Note that the shear webs increase in height as they get closer to the root. Glue them in place with medium CA. There are two additional shear webs for the rib bays between ribs 2 & 3 and 3 & 4. Glue these to the **back** of the spars between these ribs with medium CA.

10. Use medium CA to glue the 3/32" x 7/8" x 30" **trailing edge sheeting** to the TE and ribs so the end extends past the wing centerline by approximately 1/8".

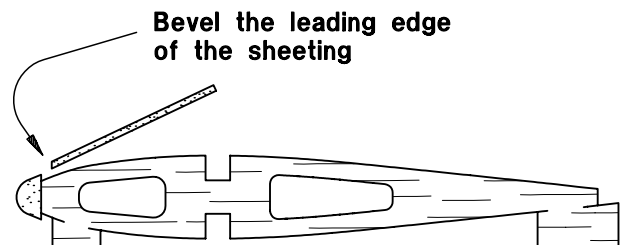

11. Without gluing, fit one of the leading edge sheets to the bottom of the wing panel by sanding a bevel on the front edge of the sheet so it matches the leading edge of the wing.

- ☐ ☐ 12. Before you glue the LE sheeting in position, remove the T-pins from the **front** jig tabs in the wing ribs.

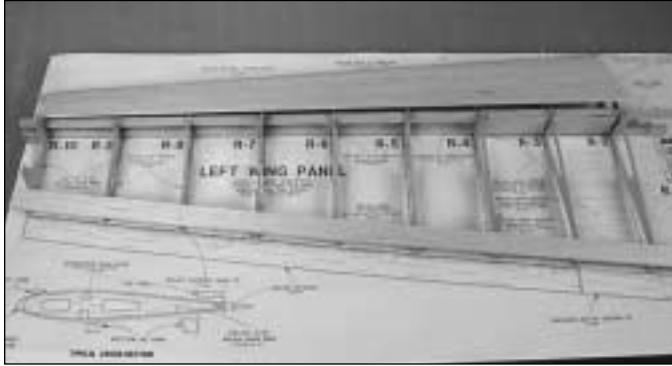

- ☐ ☐ 13. Wet the outside of the leading edge sheeting so it will bend easier. (**Hint:** a 50/50 mix of water and alcohol or ammonia helps break down the wood fibers so the sheet is even easier to bend). Run a bead of medium CA down the leading edge of the sheeting. Position the front of the sheet against the LE of the wing and use accelerator to hold it there. Wet the sheet once more if needed.

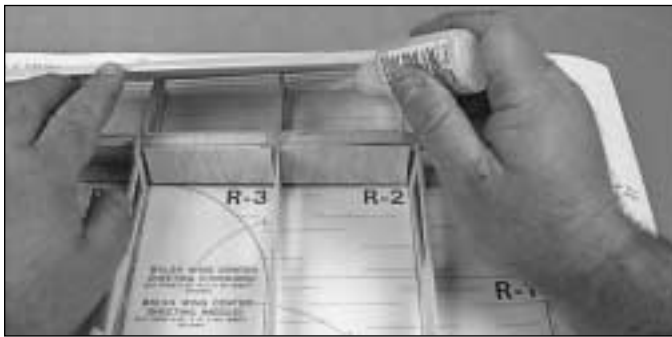

- ☐ ☐ 14. Carefully lift the sheeting away from the ribs. Working quickly, apply a bead of medium or thick CA to the top of each rib where the sheeting contacts the spar. *Pull* the sheeting back toward the main spar as you *press* it down to the ribs and spar. Use masking tape, T-pins or weights to hold the sheeting to the ribs until the CA cures.

- ☐ ☐ 15. Remove the T-pins, then flip the wing half over on your building board.

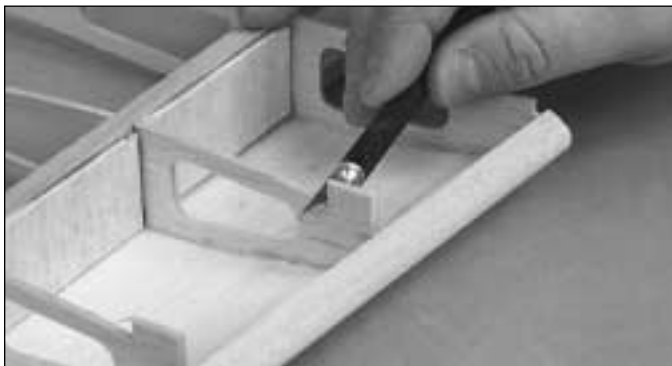

- ☐ ☐ 16. Use a sharp hobby knife to remove the tabs from the top of the wing. Use a sanding block with 220-grit sandpaper to clean the edges of the ribs where the tabs have been removed.



- ☐ ☐ 17. Using a razor saw, trim the spars, LE, TE, LE sheeting, and TE sheeting flush with R-10. Also trim the LE and LE sheeting flush with the edges of R-2.

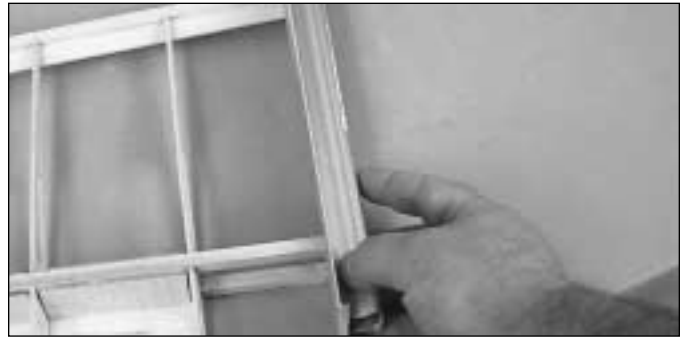

- ☐ ☐ 18. Using the spars and the TE as a guide, sand off the TE sheeting at the root of the wing.  
**Note:** DO NOT SAND the shaped TE or the spars.

- ☐ 19. Glue the TE and LE sheeting onto the top of the wing following the same procedures you used on the bottom of the wing. (Steps 10-14)

- ☐ 20. Trim and sand the TE and LE sheeting using the same procedures you did on the bottom of the wing. (Steps 16-18)



- ☐ ☐ 21. From the 3/32" x 1/4" x 24" balsa sticks, cut **cap strips** and use medium CA to glue them to the top and bottom of ribs R-4 thru R-10.

**Note:** Do not put cap strips on R-2 or R-3, as they will be sheeted after the wing halves are joined.

- ☐ Repeat steps 1 through 21 to build the **left** wing panel over the **right** wing drawing on the plan.

## Join the Wing Panels

Note: The designer wishes to assure you that the specified dihedral is correct. Although somewhat out of scale, this dihedral angle is required to eliminate roll coupling, thus providing you with a more neutral airplane. A side benefit of the dihedral is better low speed stability.

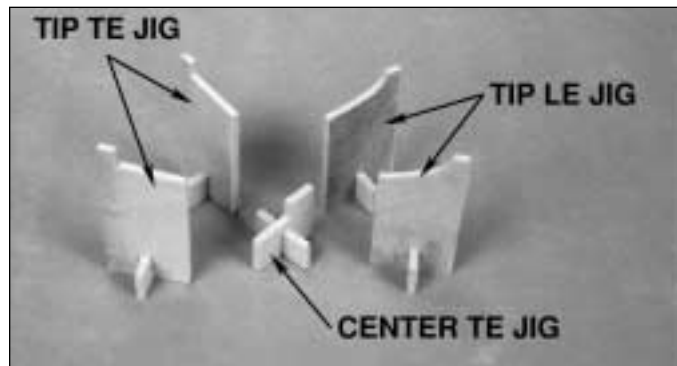

1. From the 1/8" die-cut ply pieces make the five wing jigs as shown in the photo above.



2. **Without using any glue**, test join the wing panels on the jigs as shown. Make sure the ends of the spars and TE's join **without any gaps**.

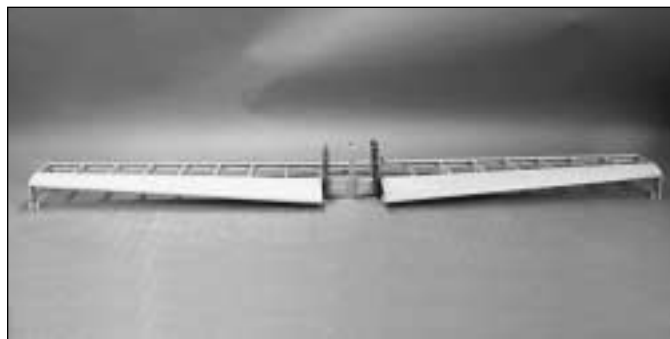

3. Place wax paper under the center of the wing to catch excess epoxy. When satisfied with the fit, glue the dihedral braces to the spars with 30-minute epoxy by spreading a film of epoxy on *both* the spars *and* the dihedral braces, followed by C-clamps to hold them in place. Once the C-clamps are tightened, wipe away excess epoxy before it cures. Place weights on top of your wing to hold it in place on the jigs.

4. Glue the TE's together with thin CA. Do not disturb the wing until the epoxy cures.

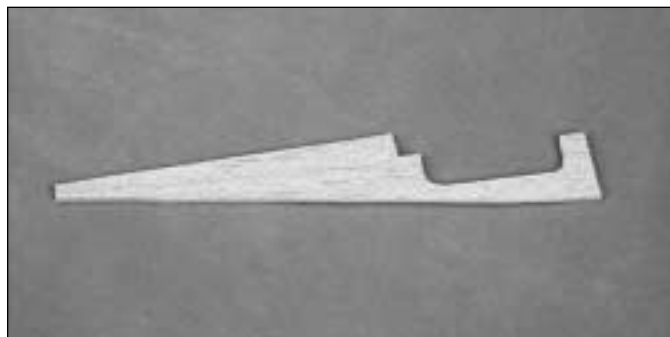

5. Trim the tabs off of both R-1 wing ribs. Laminate the two R-1's together with medium CA.



6. Glue the laminated R-1 in place aligning the bottom of the rib with the bottom of the spars.

## Sheet the Wing



❑ 1. Use medium CA to glue the die-cut 1/8" ply **aileron servo tray** and **supports** in position. Glue the die-cut 1/8" ply aileron servo tray doublers to the bottom of the aileron servo tray. Test fit your aileron servo and adjust the notch in rib R-1, if needed, so the aileron servo will fit. Remove the servo.

❑ 2. Cut the 3/32" x 3" x 36" balsa sheet into one 17-1/4" long sheet and one 18-3/4" long sheet. Cut the 17-1/4" piece in half, making two 8-5/8" long pieces. Cut the 18-3/4" piece in half, making two 9-3/8" long pieces.



❑ 3. Cut a curve on the end of one of the sheets, using the plan as a guide. The curve does not have to be an exact match. Use that one as a template to mark and cut the three other sheets.



❑ 4. Fit and glue the two 8-5/8" long pieces to the top of the wing.

❑ 5. Fit and glue the two 9-3/8" long pieces to the bottom of the wing.

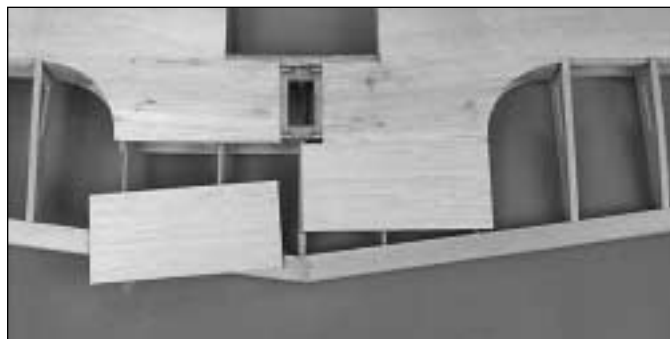

❑ 6. Cut pieces from a 3/32" x 3" x 30" balsa sheet to cover the middle portion on the top and bottom of the wing.



❑ 7. From the remaining 3/32" x 3" x 30" balsa sheet, cut a 7" long piece. Using that 7" piece, cut and fit the aft center section sheeting.

❑ 8. Using leftover 3/32" balsa, sheet the forward center section over both top and bottom spars. Sand the sheeting flush with the dihedral joiner.

## Build the Ailerons



❑ 1. Bevel the ends of the tapered, grooved balsa **center trailing edges** so they join as shown on the plan. Test fit the center TE's on the wing.



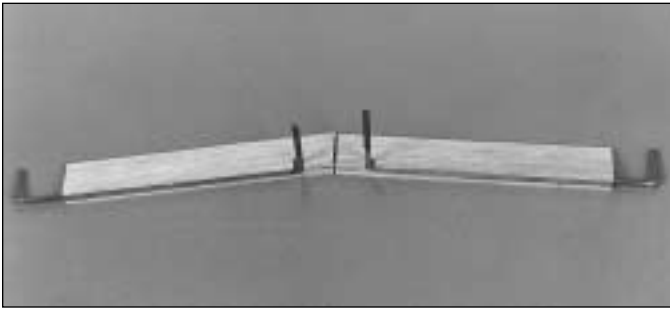

❑ 2. Place the center TE's over the wing plan and mark the location of the **aileron torque rods**. Cut notches at the marks to clear the torque rods. Test fit the torque rods to make sure the notches allow enough clearance.

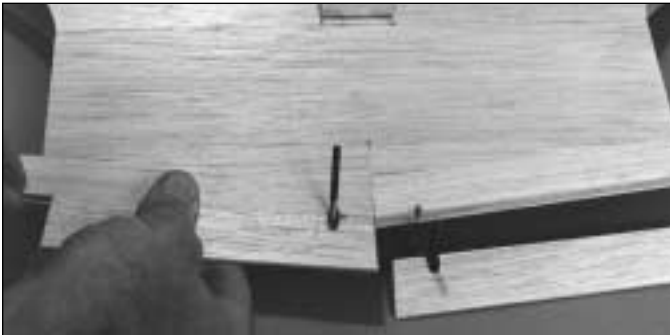

❑ 3. Position the center TE's on the wing TE with the torque rods installed, then mark the location of the notches on the wing TE. Cut the notches in the wing TE at the marks you made. Test fit the center TE's with the torque rods to make sure the notches align and are large enough to allow for proper aileron deflection.

❑ 4. Use coarse sandpaper to scuff the **nylon tube bearings** on the **aileron torque rods** so the glue will stick.

❑ 5. Use 30-minute epoxy to simultaneously glue the nylon bearing tubes in the center TE's and glue the center TE's to the wing. **IMPORTANT:** Before gluing, use a tooth pick to apply a dab of petroleum jelly to the ends of the nylon tubes to keep the epoxy out. Tape the TE's edges to the wing until the epoxy cures. Wipe away excess epoxy before it cures and do not let epoxy get into the nylon bearing tubes.

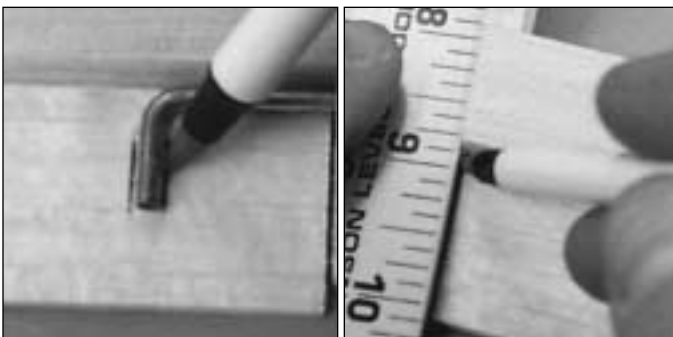

❑ 6. Position the left aileron on the trailing edge of the wing, then mark the location of the torque rod. Using a straightedge, mark the end of the aileron where it meets the wing tip.

❑ 7. Cut the aileron approximately 1/16" shorter than the mark you made at the tip so it will fit in the wing.

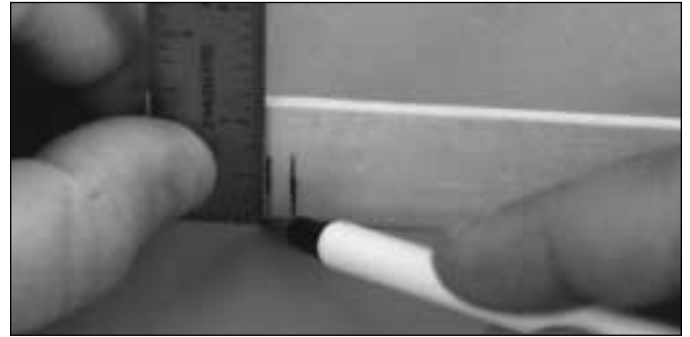

❑ 8. Use a draftsman's square to extend the torque rod marks to the front of the aileron, then use the "centerline technique" we've shown you before to mark the centerline on the entire leading edge of the aileron.



❑ 9. Use the centerline and the marks you made earlier as a guide to drill a 1/8" hole, 3/4" deep in the aileron for the torque rod.

❑ 10. Refer to the Expert Tip that follow, then cut a 1/8" groove in the leading edge of the aileron.

*EXPERT TIP*

**HOW TO CUT A GROOVE FOR AILERON TORQUE ROD**



**A.** Use a #11 knife blade to sharpen the inside end of a piece of 1/8" brass tube. Roll the tube as you *carve* the end. If you have a file or a cut-off wheel it helps to sharpen the outside of the end of the tube as well.

## BUILD THE FUSELAGE

### Assemble the Fuse Formers & Sides

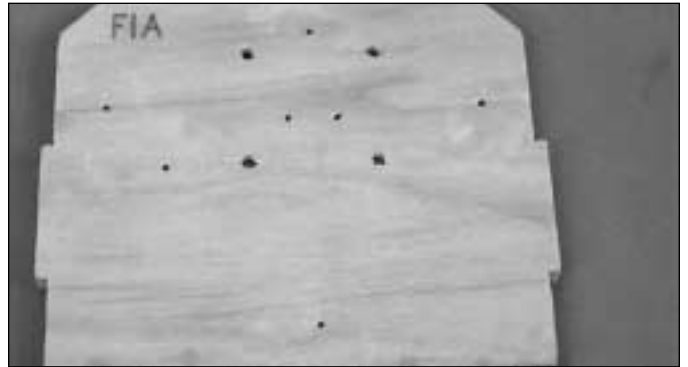

- 1. Use 30-minute epoxy to glue the **firewall formers F-1A and F-1B** together. Make sure the **embossed label on F-1A** is facing **UP** and the edges and tabs on both formers are aligned. Wipe away excess epoxy before it cures. From now on this assembly will be referred to as the **firewall**.

**Note:** If the formers are warped, simply clamping them together may not "cancel out" the warps. It is best to clamp the formers to a table or a flat board until the epoxy cures.

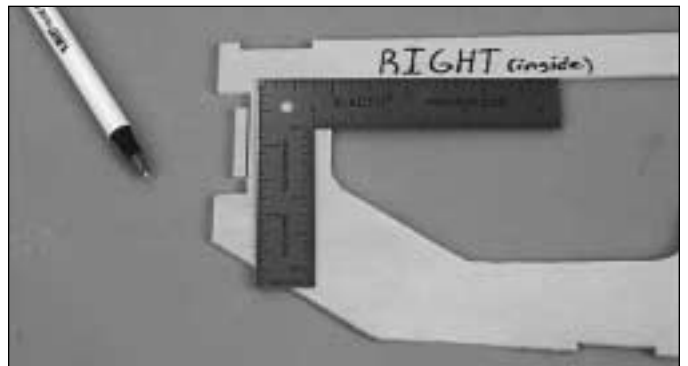

- 2. Use a straightedge and a ball point pen to draw a line across the **tab** connecting the notches in the front of only one of the **fuselage sides**. Use the line as a guide to remove the tab with a #11 knife blade. On the inside surface, label this as the **RIGHT** fuselage side.

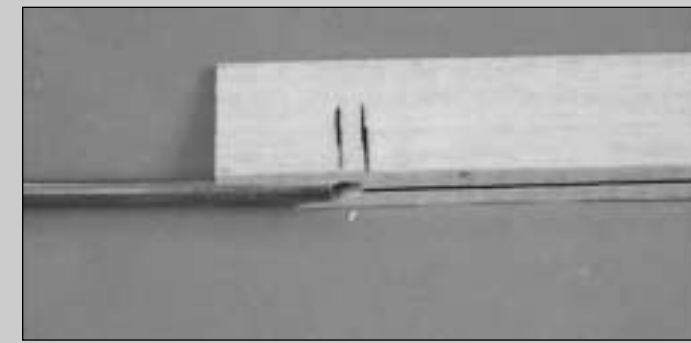

- B. Use the sharpened tube to *carefully* gouge the leading edge of the aileron. You'll have to make a few cuts to make the recess deep enough for the torque rod.

- 11. Test fit the aileron to the wing to make sure the torque rod fits and there is approximately 1/16" clearance between the aileron and the root of the wing with the aileron aligned at the tip. Make adjustments if necessary.

- 12. Mark the location of the hinges on the aileron and the wing. Cut the hinge slots. Without using glue, test fit the aileron to the wing with the hinges.

- 13. Remove the aileron from the wing. Mark the "bevel to" lines and shape the leading edge of the aileron to a "V" as shown on the plan the same way you did for the elevator and the rudder.

- 14. Perform the same steps to shape the right aileron and fit it to the wing.

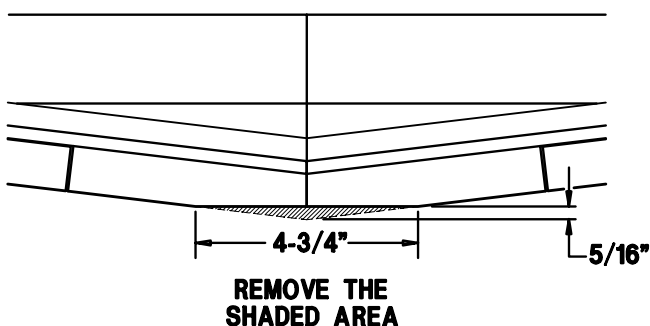

- 15. Sand approximately 5/16" into the TE at the centerline. (The flat will end up approximately 4-3/4" wide).

- 16. Use lightweight balsa filler such as HobbyLite to fill glue joints or dents in the wing. After the filler has fully dried use your bar sander to sand the wing using progressively finer grades of sandpaper so it is smooth and all the joints are blended.

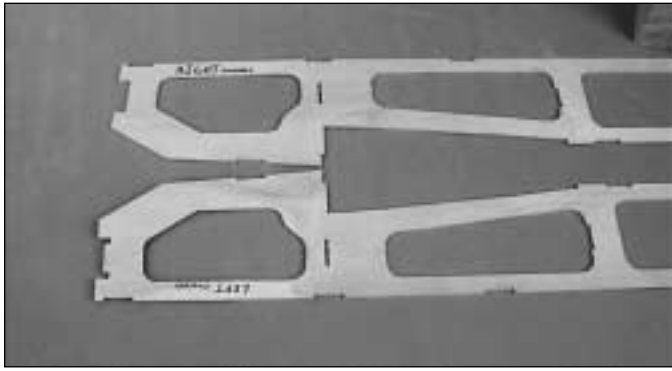

❑ 3. Lay the other fuselage side next to the right side **as shown in the photo** and label it on the inside as the **LEFT**. It is important that you lay the fuselage sides in a mirrored position to insure that you build a right and a left half.

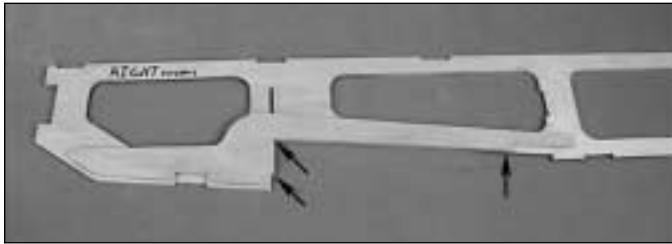

❑ 4. Use medium CA to **accurately** glue a **fuselage doubler** to the **inside** of the **right** fuselage side. Make sure the doubler aligns with the fuselage side where the arrows indicate in the photo.

❑ 5. Glue the left fuselage doubler to the left fuselage side in the same manner.

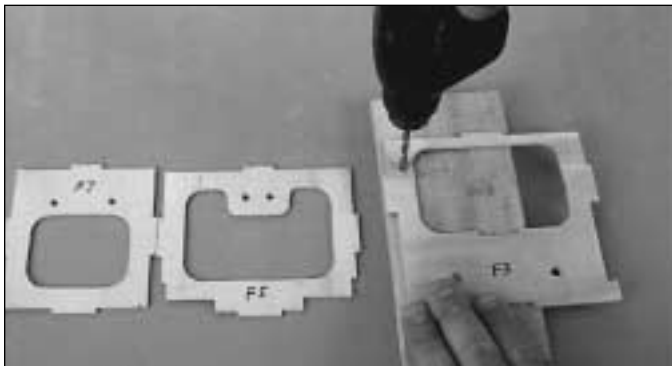

❑ 6. Drill a 3/16" hole through each of the punch marks in **formers F-3, F-5 and F-7**

**Hint:** Place the formers on a scrap piece of wood and press down as you drill the hole so the former does not split when the drill goes through.

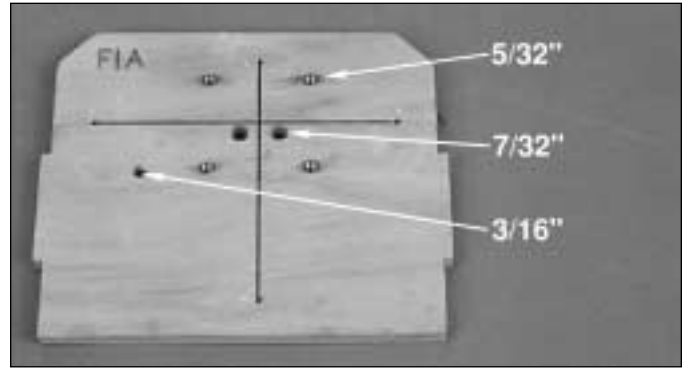

❑ 7. Draw center lines connecting the outer punch marks on the **firewall**. Drill 5/32" holes for the engine mount bolts at the four engine mount punch marks. Drill a 3/16" hole for the throttle pushrod at the punch mark. Drill two 7/32" holes for the fuel line.

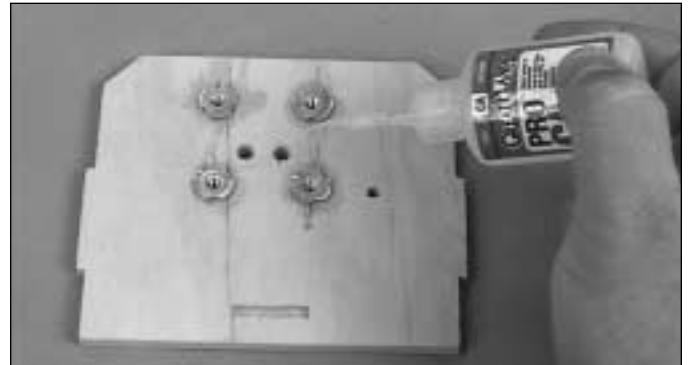

❑ 8. Press four supplied **6-32 blind nuts** into the holes on the back of the engine mount. Gently tap the blind nuts with a hammer to fully seat them into the firewall. Add a few drops of thin CA around the blind nuts to secure them.

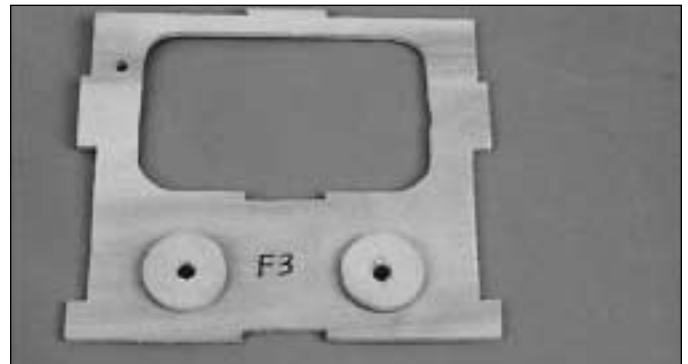

❑ 9. Align the **F-3 doublers** over the die-cut holes in F-3, and glue them in place using medium CA.

## Assemble the Fuselage

**Note:** The interlocking construction this Great Planes kit allows you to quickly assemble the fuselage upside down on the plan while maintaining alignment. You will be fitting most of the die-cut fuselage parts together before applying glue. **Do not use any glue until instructed to do so.**



1. Pin the die-cut **fuse top** in position over the fuselage bottom view on the plan. Make sure the front of the fuse top lines up with the firewall on the plan, as this sets the right thrust.

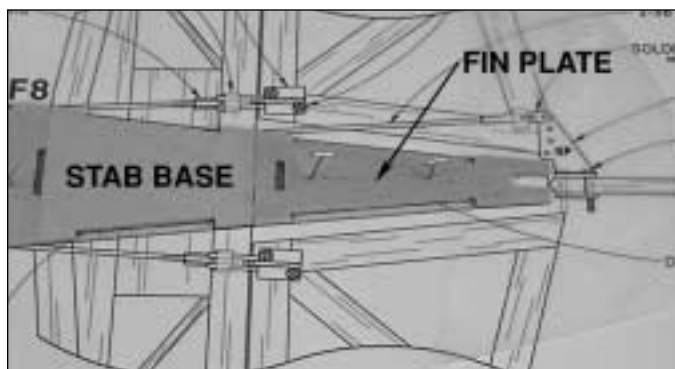

2. Pin the die-cut **fin plate** in place, using the die-cut **stab base** to correctly locate it. After you have the fin plate pinned in position, remove the stab base.

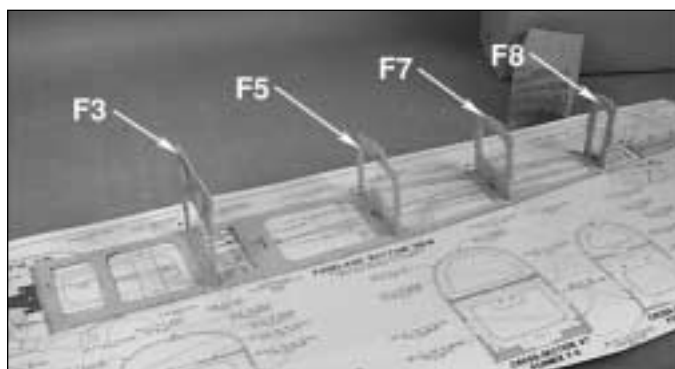

3. Place formers **F3**, **F5**, **F7** and **F8** in position on the fuse top. The doublers on F3 face forward, toward the nose.

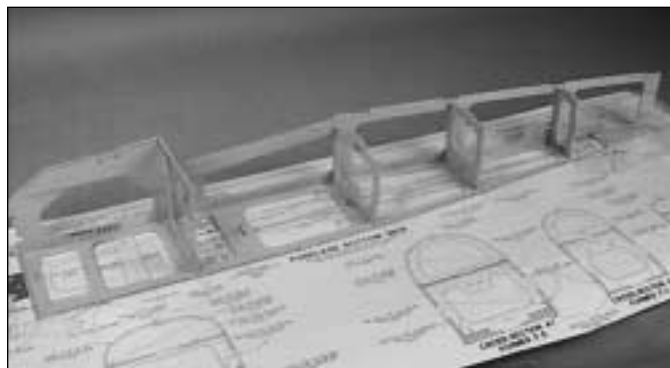

4. Fit the **left fuse side** to the formers and fuse top. Do not glue.



5. Fit the **right fuse side** to the formers and fuse top.



6. Fit the **fuse bottom** in place. **Note:** the landing gear base does not get installed until after the wing is mounted.



7. Using a square, check that the fuse sides are perpendicular to the work bench. Using thin CA, glue each corner former to the fuse top, bottom and sides. Double check every former to make sure it is square.

- ❑ 8. Glue the fuse sides to the fuse top and bottom with thin CA. Leave the fuse assembly pinned to your work surface.



- ❑ 9. Fit two of the die-cut 1/8" ply **bolt plates** in place on the fuse and mark as shown in the photo.

- ❑ 10. Using medium CA, laminate the two marked plates onto the two unmarked plates.



- ❑ 11. Mark 1/16" down on the TE of each laminated block. Using your bar sander, sand a taper between the two lines.



- ❑ 12. Using 6-minute epoxy, securely glue the wing bolt blocks in place.

## Mount the Wing to the Fuselage

- ❑ 1. Sand the entire wing saddle area lightly until the fuse side doublers and fuse sides are flush.

- ❑ 2. Trial fit the wing on the fuse. If the wing is slightly too large (front to rear) to fit into the saddle, sand the **TE** of the wing slightly until it fits.

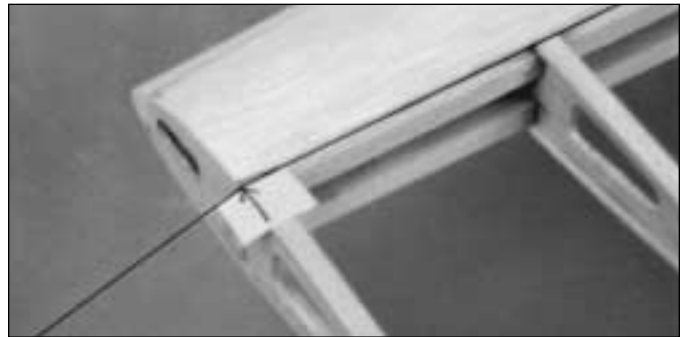
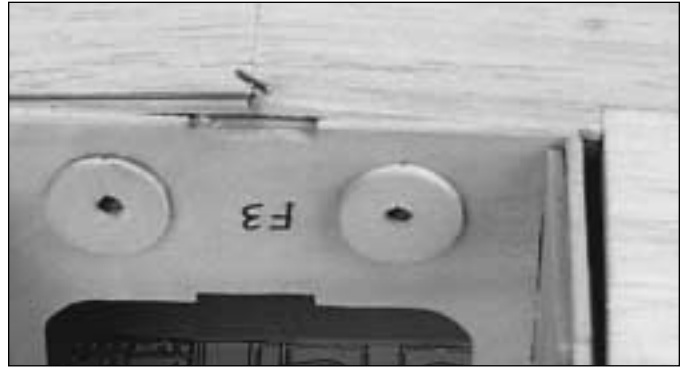

- ❑ 3. Center the wing side to side as follows: Stick a T-pin in F-3 aligned with the center mark. Tie a piece of string around the T-pin. Pull the string to the wing tip and put a piece of masking tape on the string at the wing tip. Mark an arrow on the tape, then slide the tape on the string so the arrow aligns with the wing tip. Swing the string over to the other tip and see if it aligns with the other wing tip. If necessary, shift the wing and mark the location of the tip by adjusting the position of the tape on the line. Do this until the arrow on the string aligns with both tips. Measure down from the bottom of both tip ribs to the flat surface. If the measurements are not equal (within 1/16"), sand the saddle until the wing sits level.



- ❑ 4. While holding the wing firmly in place, drill 1/4" holes through the front and back dihedral braces as shown. Remove the wing from the fuse.

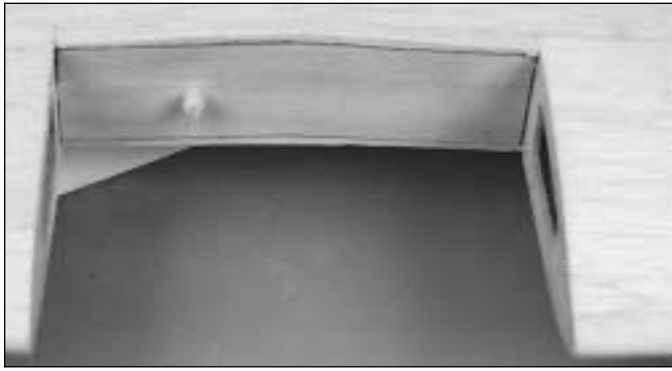

❑ 5. Slightly round one end of a 1/4" x 1-1/8" **wing dowel**. Using 6-minute Epoxy, glue the dowel in the wing leaving 3/8" protruding from the front of the dihedral brace.

❑ 6. Allow ample time for the epoxy to cure. Then, fit the wing back onto the fuselage, drill the second dowel hole, remove the wing, and glue the second dowel in place.

*Time to use your string again.*



❑ 7. Stick the T-pin through the center of the aft end of the fuselage bottom. Pull the line to the TE of the wing tip and move your tape to that point. Swing the string over to the other tip and see if it aligns with the same point. If necessary shift the wing and mark the location of the tip by adjusting the position of the tape on the string. Do this until the arrow on the string aligns with both tips.

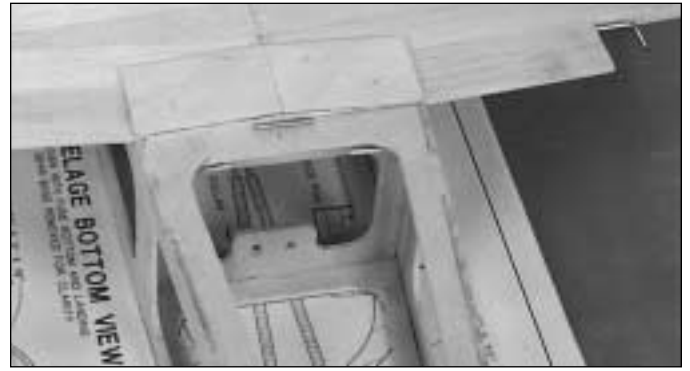

❑ 8. Now that the wing is accurately aligned, glue the wing bolt plate in place on the wing, being careful not to glue the wing to the fuselage.

**Note:** The punch marks in the wing bolt plate are closer to the TE of the bolt plate.



❑ 9. Holding the wing firmly in place, drill 13/64" holes through the punch marks in the bolt plate, drilling through the wing and the laminated bolt blocks. Try to drill straight in, perpendicular to the bolt plate. **Note:** Do not allow the wing to move while drilling.

❑ 10. Remove the wing and re-drill the holes in the **wing only** to 17/64".



❑ 11. Use a 1/4-20 tap and a tap wrench to cut threads in the laminated bolt blocks in the fuselage.

❑ 12. Harden the threads in the bolt blocks with thin CA, then re-tap the threads after the glue is **completely** dry.

*We are almost ready to unpin the fuselage from the building board -- just a few more steps.*

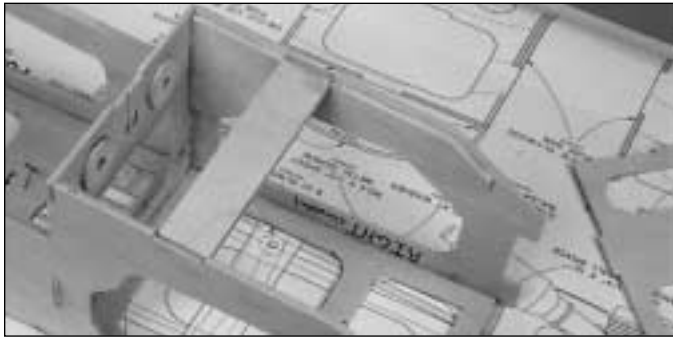

- ❑ 13. Glue the 1/4" ply **landing gear rail** in position with 6-minute epoxy.

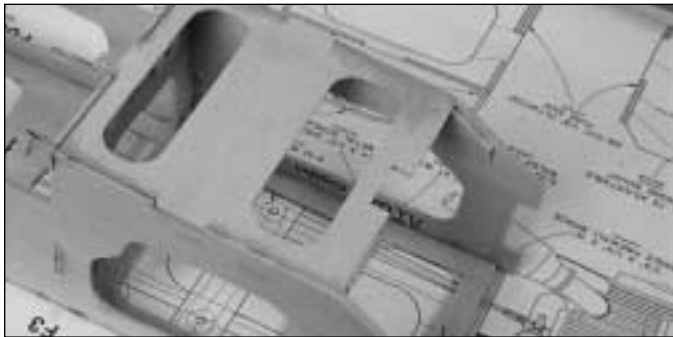

- ❑ 14. Glue the **landing gear base** in place with thin CA.



- ❑ 15. Center the **landing gear** between the tabs on the landing gear base, and drill 13/64" holes through the landing gear base and rail, making sure the gear does not shift.

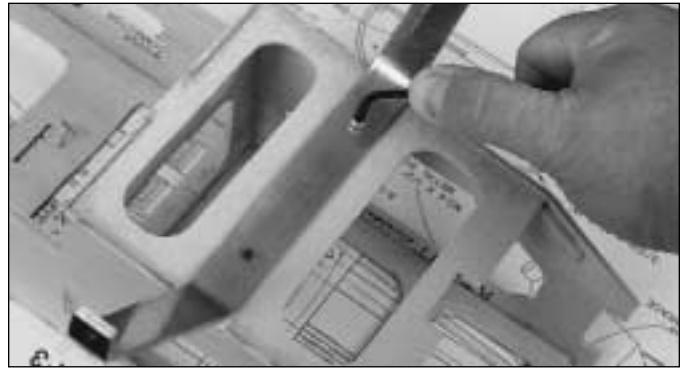

- ❑ 16. Install **8-32 blind nuts** supplied with this kit into the landing gear rail from inside the fuselage. Use the 8/32" x 3/4" socket head cap screws through the landing gear to pull the blind nuts into position.

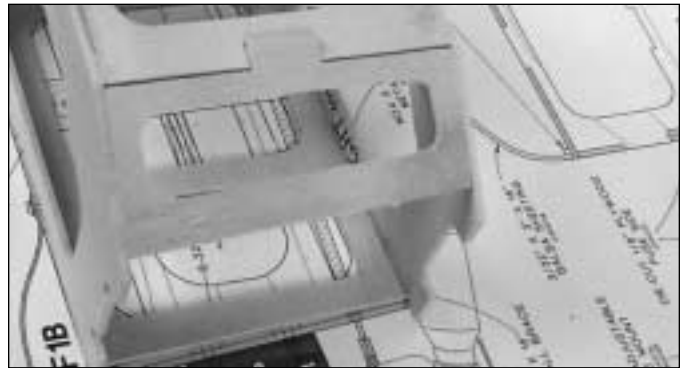

- ❑ 17. Glue F1C in place with thin CA.

*Finally, it's time to un-pin the fuse from your work table.*

- ❑ 18. Double check all of the glue joints. Reinforce with medium CA as needed.

- ❑ 19. Install the wing onto the fuse.



- ❑ 20. Cut the 3/16" x 1-3/4" x 10" balsa stick in half, making two 5" **wing root spacers**. Use a playing card or business card to shim between the spacers and the fuse. Use medium or thick CA to glue the balsa wing root spacers to the wing.

**Note:** It may be necessary to sand the spacers slightly thinner, or to apply filler to result in a 1/32" gap between the spacers and the fuse.

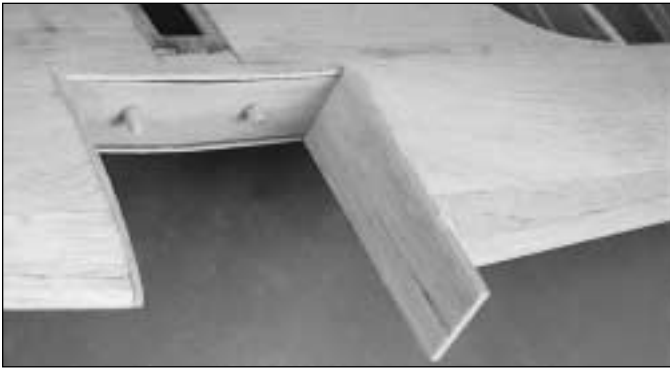

❑ 21. After the filler has fully dried, remove the wing from the fuselage. Cut and sand the spacers and the filler to match the contour of the wing.

❑ 22. Cut a 36" **plastic outer pushrod tube** in half, making two 18" lengths. Sand the outside of the tubes with coarse sandpaper so the glue will stick.

❑ 23. Install the tubes through the guide holes in the formers. Approximately 1" of the tubes should protrude outside the slots at the aft end of the fuse.

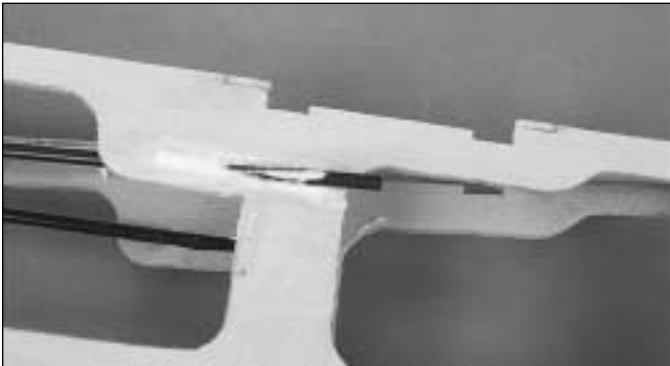

❑ 24. Glue the tubes into the slots at the end of the fuselage with microballoons and epoxy. Completely fill the slot with the microballoons and epoxy so it can be sanded flush later. Glue the tubes to the formers with medium CA.



❑ 25. After the epoxy has cured, use your bar sander and 150-grit sandpaper to sand the outer pushrod tubes and epoxy filler flush with the fuselage sides.

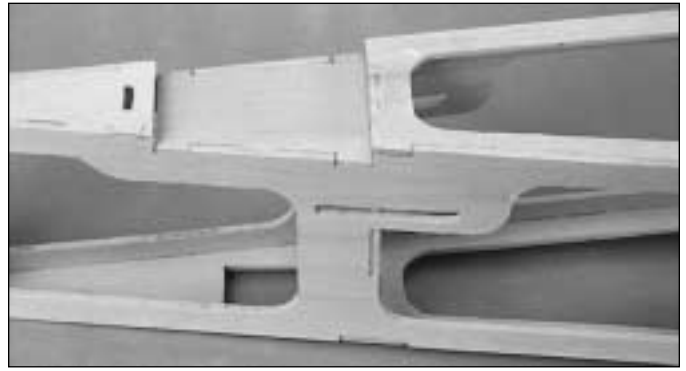

❑ 26. Glue the **stab base** in place with thin CA.



❑ 27. Use 30-minute epoxy to glue the firewall in position. Use masking tape or clamps to hold the firewall until the epoxy cures.



❑ 28. From the 3/8" x 3/8" x 12" **balsa triangle**, cut two pieces 1-1/4" long. Glue them in place on top of the laminated wing bolt blocks with 6-minute epoxy.



❑ 29. From the remaining 3/8" x 3/8" balsa triangle, cut pieces to fit and glue them to the back of the firewall with 6-minute epoxy.



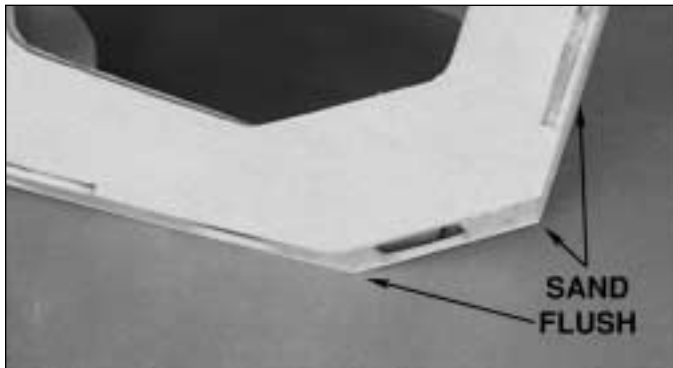

❑ 30. Sand the fuselage sides flush with the firewall. Sand the bottom of the firewall flush with F1C. Sand the bottom of F1C flush with the landing gear base.

### ***Build the Front Fuselage Deck***

**Note:** The front and the rear of the front deck use the same pieces (F-2), but the front F-2 is 90 degrees to the fuse and the rear F-2 must be set at an angle using the IP (instrument panel) gauge.

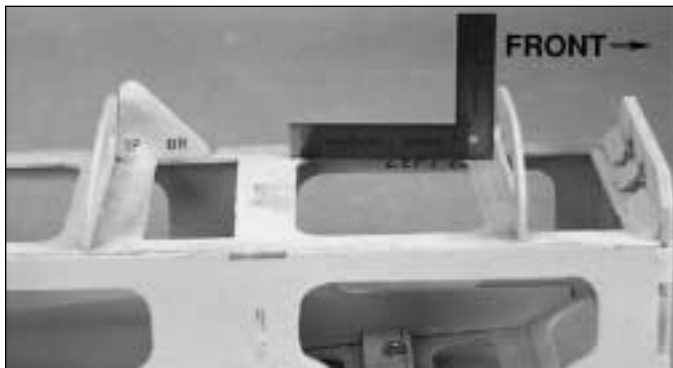

❑ 1. Using a 90 degree triangle for alignment, glue the **front** die-cut 1/8" plywood **F2** in place.

❑ 2. Use the IP gauge while gluing the **rear** die-cut 1/8" plywood **F2** in place.



❑ 3. From the 1/8" x 1/4" x 30" balsa stick, cut an 8" piece for the **front deck main stringer**. Glue this stringer into the notches in both F2's.

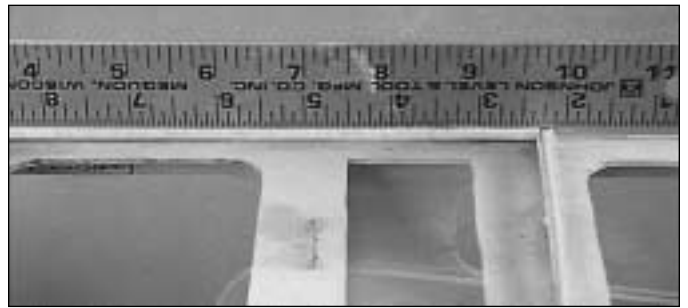

❑ 4. From the 1/8" x 1/8" x 30" balsa stick, cut two 7-1/8" long **gluing stringers**. Use a straightedge held on top of both F-2's to position the right gluing stringer. With medium CA, attach the gluing stringer to the right side of the main stringer.

❑ 5. Glue the left gluing stringer in place on the left side of the main stringer.

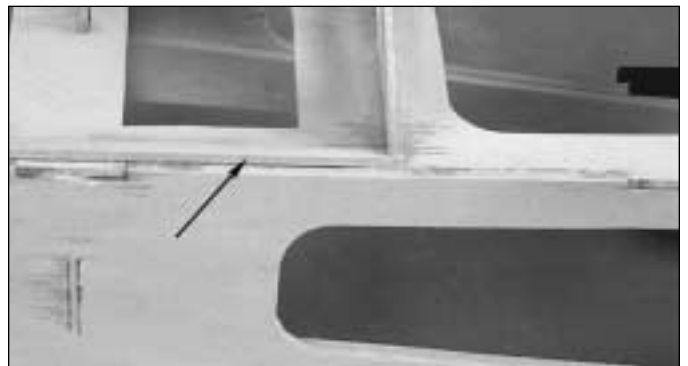

❑ 6. From the same 1/8" square balsa, cut two more pieces 7-5/8" long. Glue these in place at the bottom corners of both F-2's on both sides.

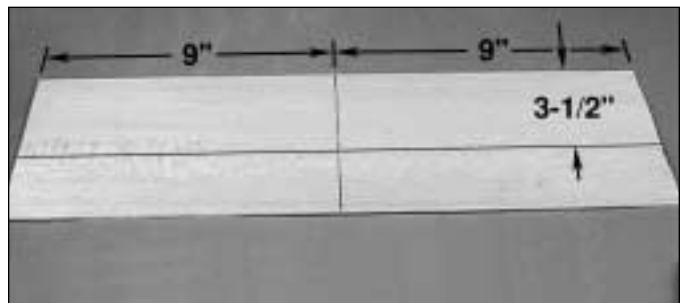

❑ 7. Edge glue two 3/32" x 3" x 18" balsa sheets together. Use your draftsman's square to mark a centerline, then cut the two sheets in half, making two 6" x 9" sheets. Cut each piece so that it measures 9" x 3-1/2" as shown in the photo, making the front deck sheeting.



❑ 8. Use medium CA to glue the front deck sheeting to the main stringer, keeping it down tight against the gluing stringer. Do not try bending the sheeting yet.

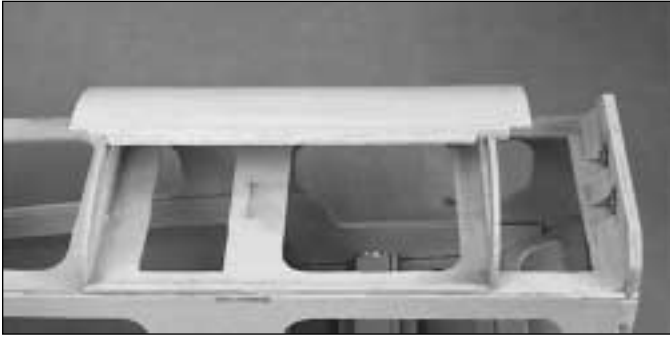

❑ 9. Wet the sheet with the water and alcohol solution, then carefully test bend it into position. Some trimming may be necessary to get a good fit. Apply more water and alcohol if needed to bend the sheet. Apply medium CA to the formers and to the bottom gluing stringer, and press the front deck sheeting in place. Use masking tape to hold it in place.



❑ 10. After the water has evaporated remove the tape. Fit and glue the other sheet to the fuselage.

❑ 11. Use your bar sander and 150-grit sandpaper to sand the sides and top of the front deck sheeting so they are even with the fuse sides. Trim the ends of the sheeting so they are flush with both F-2's.

❑ 12. Sand the main stringer so it blends with the sheeting.

### ***Mount the Stabilizer to the Fuselage***

❑ 1. If you have not already done so, make sure the stab and fin are final sanded to a smooth finish, as it will be a little more difficult to do so after they are glued to the fuselage.

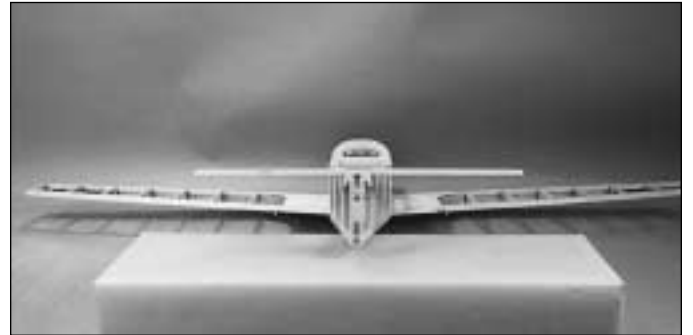

❑ 2. Mount the wing to the fuselage, then position the stab on the fuselage. Stand about six to ten feet behind the model and see if the stab is even with the wing. If necessary, use your bar sander to make adjustments by sanding the stab base until the stab is in alignment with the wing.

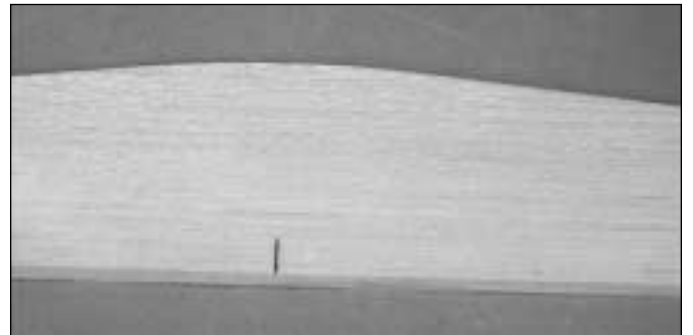

❑ 3. Accurately measure the trailing edge of the stabilizer and use a ball point pen to lightly mark the center. Use the same procedure to mark the center of the fin plate where the trailing edge of the stab will contact it.



❑ 4. Place the stab on the stab base with the center marks aligned, then use a large T-pin to pin **only the trailing edge** of the stab to the stab base.

❑ 5. Stick a T-pin through the forward fuse deck sheeting above F2 in the center of the middle stringer, then use the "pin and string technique" to accurately align the stab with the fuselage. Once the stab is accurately aligned, pin the LE of the stab to the stab base.

❑ 6. Carefully turn the fuselage over and use a ball point pen to **lightly** mark where both fuselage sides contact the bottom of the stab.

❑ 7. Remove the stab from the stab base but leave the T-pins in the stab. Apply a film of 30-minute epoxy to the stab base and to the stab between the lines you marked indicating the fuselage sides.

❑ 8. Reposition the stab on the stab base and reinsert the T-pins into the same holes. Use the string to confirm the stab alignment. Then, use weights, more T-pins or clamps to hold the stab in position. Wipe away excess epoxy before it cures. Recheck alignment. Do not disturb the model until the epoxy cures.

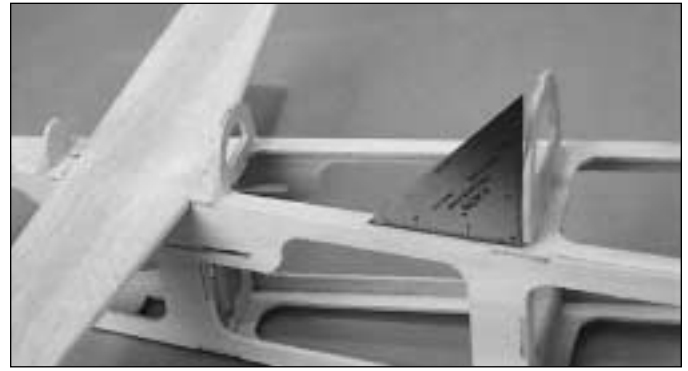

❑ 2. Use a square to position and glue the die-cut 1/8" ply formers F-6, F-9, and F-10 vertically, at 90 degrees to the fuse top.

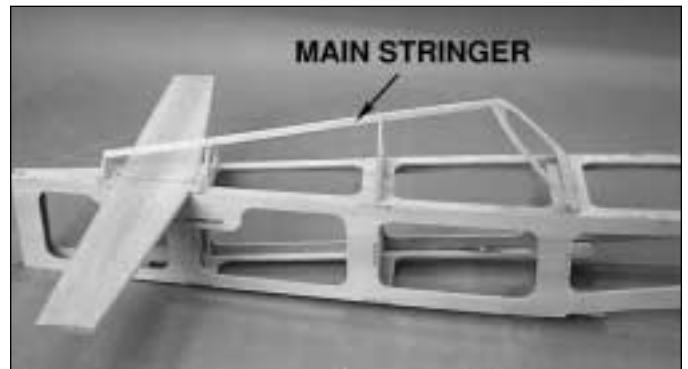

❑ 3. Glue the remaining 1/8" x 1/4" balsa **main stringer** to the top of the turtle deck formers. Be sure to keep it centered on F-4, F-6, F-9 and tight in F-10. After the glue cures cut the stringer flush with the rear of F-10 and the front of F-4.

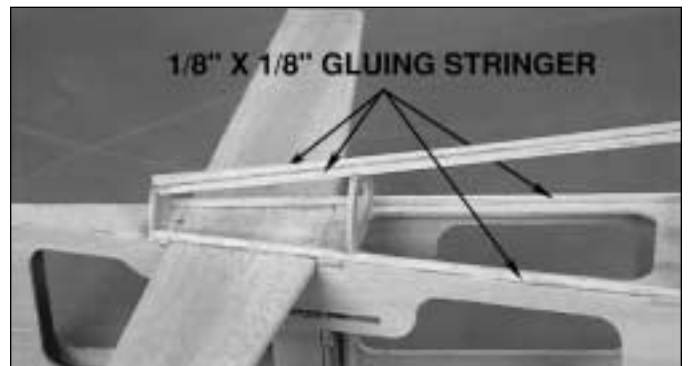

❑ 4. Glue the four 1/8" x 1/8" balsa **gluing stringers** in place as you did on the front deck, using a straightedge.

## Build the Turtledeck

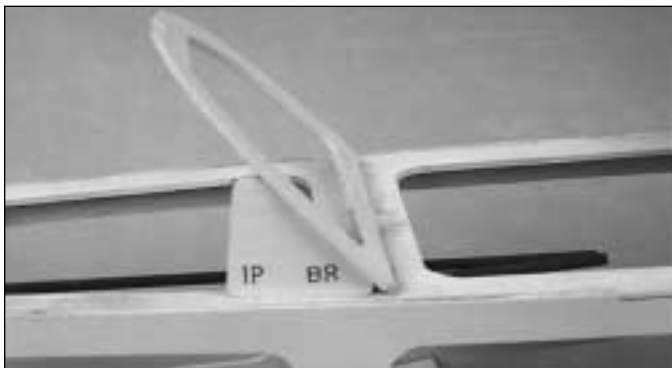

❑ 1. Glue the die-cut 1/8" ply "backrest" (**F4**) to the fuse top, using the "backrest gauge" (**BR**) to set it at the correct angle. **Note:** The gauge is used only for setting the angle (do not glue the gauge in).

- ❑ 5. Edge glue three 3/32" x 3" x 18" balsa sheets together, making a 9" x 18" sheet.

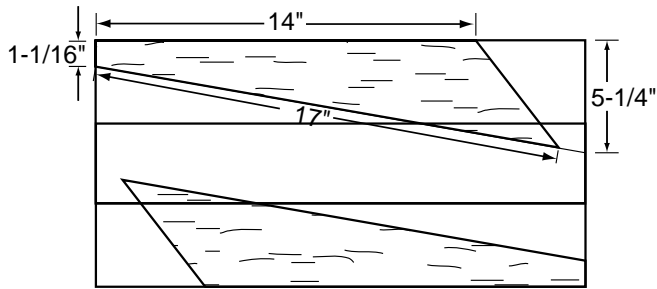

- ❑ 6. Prepare the two turtle deck sheets by cutting the balsa sheet you made in step 5 to the sizes shown in the sketch.



- ❑ 7. Glue both turtle deck sheeting pieces to the fuse top as shown.  
**Note:** The grain runs parallel to the top stringer, **NOT** the fuse top.



- ❑ 8. Wet the outside of the sheeting with your water and alcohol solution. Wrap the sheeting around the formers and tape it in place. Let the sheeting dry before trying to fit the sheeting to the main stringer.

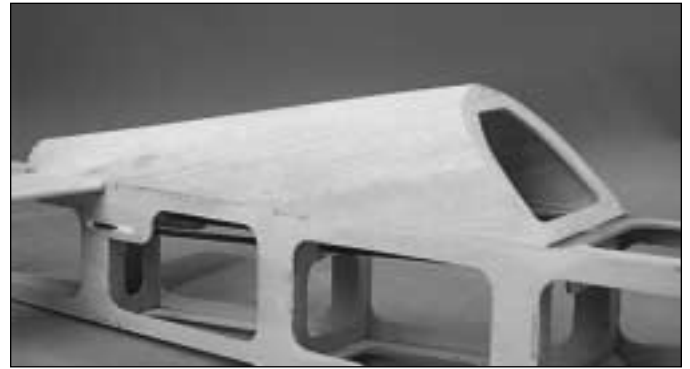

- ❑ 9. Now that the sheeting has conformed to the turtle deck shape, trim the top edge so that the sheeting fits tight against the gluing stringer. Glue the sheeting to the gluing stringer, main stringer, and formers.



- ❑ 10. Sand the sheeting flush with the rear of F9 and the front of F4.



- ❑ 11. Cut the 5/8" x 1" x 8-7/8" balsa stick into two 4" long **fin fillets**. Hold the 1/4" x 1" x 4" balsa **dummy fin** centered on and vertical to the fin base. Mark **THE FIN BASE** on both sides with a pen.

- Note:** It is **VERY IMPORTANT** that the dummy fin align with the centerline of the fuse. A good way to check this is to sight down the dummy fin, aligning it with the main stringer on the turtle deck.

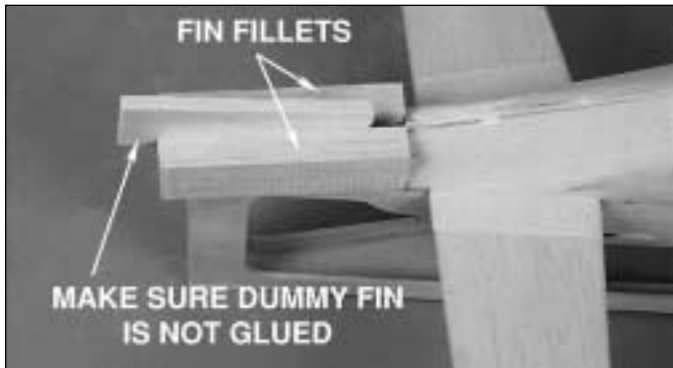

❑ 12. Glue one side of the fin fillet to the fuse top and former F-9. **DO NOT GLUE** it to the dummy fin. Allow the glue to dry thoroughly before gluing the other fin fillet in place.

**Note:** The dummy fin is only used as a temporary spacer, so don't glue it in place.

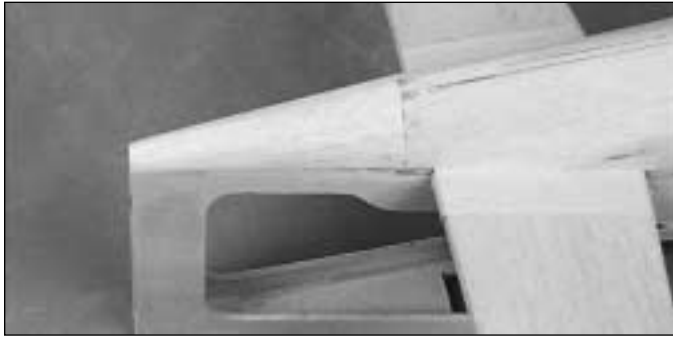

❑ 13. Carve and sand the fin fillets and dummy fin to blend smoothly with the fuse sides and the turtle deck.

**Note:** Masking tape around the stab at the root will make it less prone to nicks while sanding the fillets.

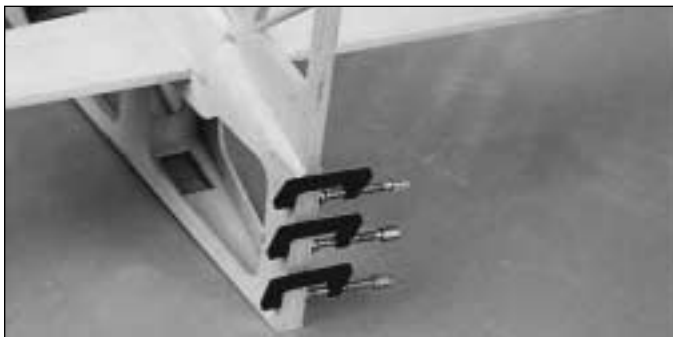

❑ 14. If you have not already done so, final sand the fin. Remove the dummy fin and put the fin in its place. Before gluing, double check to make sure the fin aligns with the fuse centerline. Glue the fin in place with 30-minute epoxy. Use clamps to hold the fuse sides tight against the fin until the epoxy has thoroughly cured.

## Mount the Engine

❑ 1. Cut the "spreader bar" from the supplied Great Planes engine mount, then use a hobby knife to remove any flashing left over from the molding process so the halves fit together well.

❑ 2. Temporarily mount the engine mount to the firewall with four 6-32 x 1" Phillips head machine screws and #6 flat washers. Do not tighten the screws all the way, because you still need to adjust the mount.

❑ 3. Place your engine on the mount and slide the halves in or out until the engine fits properly. Position the mount so the molded-in "tick marks" are equally spaced on both sides of the horizontal centerline you drew. When the engine mount is adjusted and positioned, tighten the mounting screws.

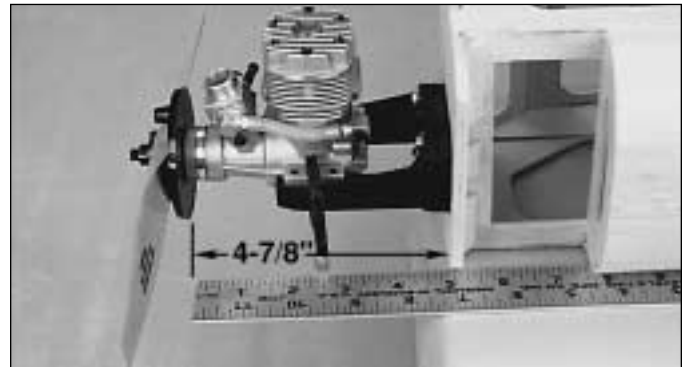

❑ 4. Position the engine on the mount so the front of the drive washer (or the back of the spinner) is 4-7/8" away from the firewall. Mark and drill 7/64" engine mounting holes for the #6 x 3/4" engine mounting screws. Mount the engine.

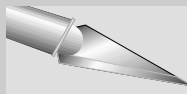

## EXPERT TIP

### HOW TO ACCURATELY MARK AND DRILL THE ENGINE MOUNTING HOLES ON THE ENGINE MOUNT

A. Use C-clamps to hold the engine in position.

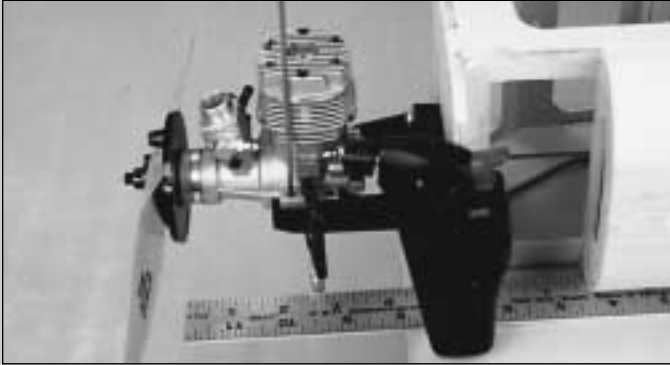

B. Heat the end of a sharpened wire rod and mark the center of the engine mounting holes on the engine mount. It just takes a little pressure from the heated rod to dimple the plastic.

C. Remove the engine, then use a pin vise or an electric drill to start the holes with a 1/16" drill bit.

D. Remove the engine mount from the fuselage. Use a drill press or your hand held electric drill to drill the 7/64" holes.

**Optional:** Modelers who prefer to mount their engine with machine screws instead of sheet metal screws should drill the engine mounting holes with a #36 drill, and tap the holes with a 6-32 tap. 6-32 x 3/4" screws (not supplied) are recommended.

### Install the Battery & Tank

1. Assemble the fuel tank per the manufacturer's instructions. Connect approximately 12" of fuel tubing to the fuel pick-up fitting on the tank and 12" of fuel tubing to the pressure fitting.

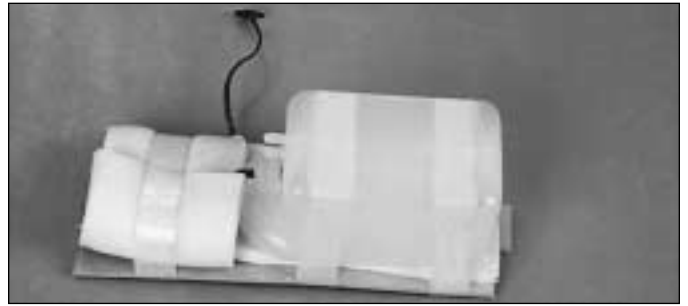

2. Attach the battery and the tank to the die-cut 1/8" tank floor (TF) with nylon tape as shown in the photo. Make sure the embossed label TF is towards the tank.

**Note:** If you are using the OS .46 FX engine, the battery should be installed on the tank mount as shown. If you are using the OS .70 Surpass, then install the battery on a left-over piece of 1/8" ply at the location shown on the plan.

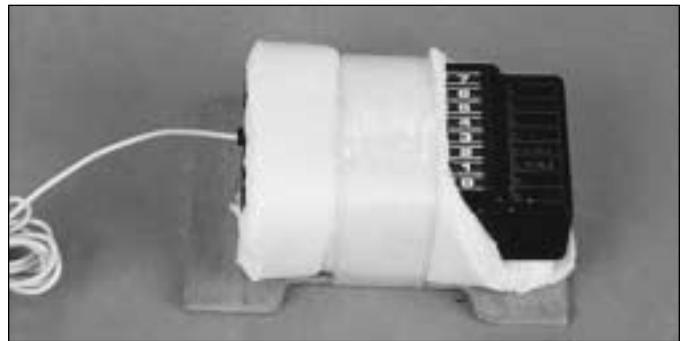

3. Attach the receiver, wrapped in foam, to the 1/8" die-cut receiver tray (RT) with nylon tape.



4. Fit the TF in the fuse as shown. The front tab fits in the slot in the bottom of the firewall and the rear tab fits in the slot in F-3. Attach the die-cut 1/8 ply tank floor retainer to F-3 with two #2 x 3/8" sheet metal screws.

**Note:** This method of mounting the tank makes it easy to remove the tank and battery. However, after final assembly it will be necessary to first remove the throttle and elevator servos to remove the tank.

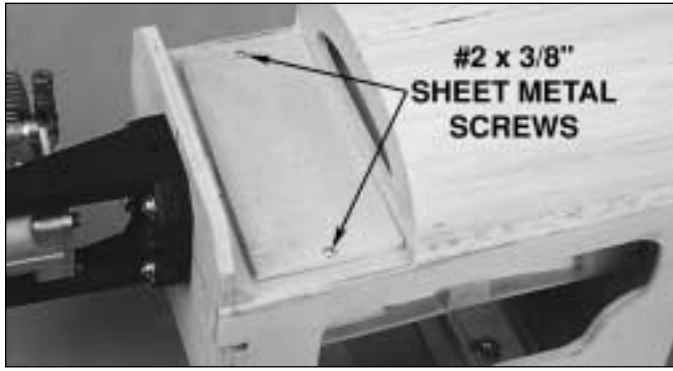

❑ 5. Install the die-cut 1/8" ply **tank hatch** with two #2 x 3/8" sheet metal screws.



❑ 3. Place the throttle servo in the servo tray. Temporarily install the brass Screw Lock Pushrod Connector into the throttle servo arm, then adjust the bend in the throttle pushrod if necessary and fit it into the connector. When satisfied with the fit of the pushrod, mount the servo to the servo tray with the screws provided with the radio system.

❑ 4. Cut 11" off one end of one of the 35" wire pushrods. Cut 13" off the end of the other 35" wire rod. Set the short pieces aside and save them for the aileron pushrods. Thread a nylon clevis about 20 turns onto the end of one of the long rods, then remove the **backing plate** from a nylon **control horn** and connect the clevis to the horn using the outer hole. Make another pushrod assembly from the other long rod with a clevis and control horn, in the same manner.

### ***Install the Servos & Make the Pushrods***

❑ 1. Use coarse sandpaper to roughen the outside of the throttle pushrod tube so glue will stick. Use medium CA to glue the pushrod outer tube into F3 and the firewall. Cut the pushrod outer tube flush with the outside of the firewall.

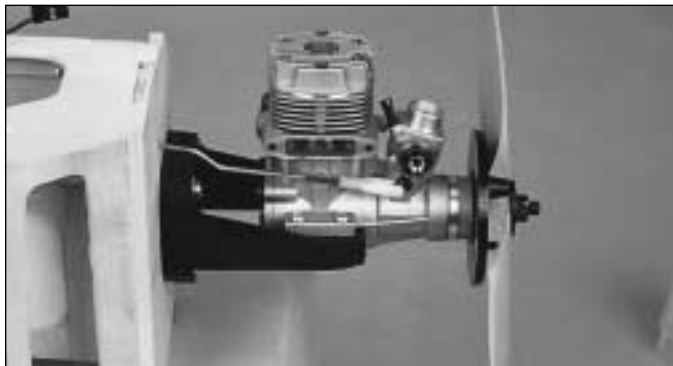

❑ 2. Bend and cut the 17-1/2" throttle pushrod wire to fit your engine installation using the drawing on the fuselage plan as a guide. Install a nylon clevis and insert the pushrod through the guide tube. Make adjustments to the bends in the wire so the pushrod aligns with the carburetor arm on the engine, then temporarily connect the clevis to the carb arm. Temporarily mount the muffler and make sure the throttle pushrod will not interfere with the muffler. Make adjustments to the bends in the wire if necessary.

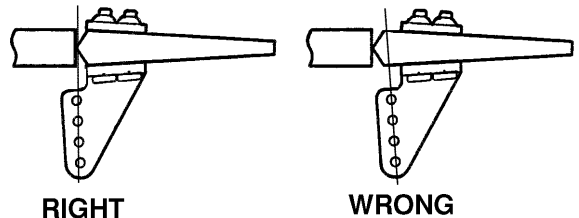

❑ 5. Insert the pushrods into the pushrod tubes. Position the control horns on the elevators as shown in the sketch and on the plan. Use a ballpoint pen to mark the location of the control horn mounting holes and drill 3/32" holes through the elevators at the marks. Temporarily mount the control horns to the elevators with the backing plates and 2-56 x 5/8" screws.



6. With the elevator servo set in place, the servo control horn centered and the control surfaces in their neutral position, use a felt tip pen to mark where the **longer** pushrod crosses the mounting holes in the servo arm.



7. Disconnect the clevis from the control horn on the wire you marked. Make a 90 degree bend at the mark you made. Temporarily install a nylon Faslink™ on this pushrod, then cut the wire so it slightly protrudes out of the Faslink. **Hint:** If you prefer to bend and cut the pushrod **out of the fuselage** remove the pushrod, make the 90 degree bends and cut the wire. Unscrew the clevis and reinstall the pushrod in the guide tube from the front. Screw the clevis back on.

8. Slide two 5/32" wheel collars onto the pushrod. Connect the pushrod to the servo with the Faslink. **Note:** If necessary, enlarge the hole in the servo arm with a hobby knife (or a #48 drill for precision). Let the pushrod locate the servo in the servo tray. Screw the elevator servo in place.

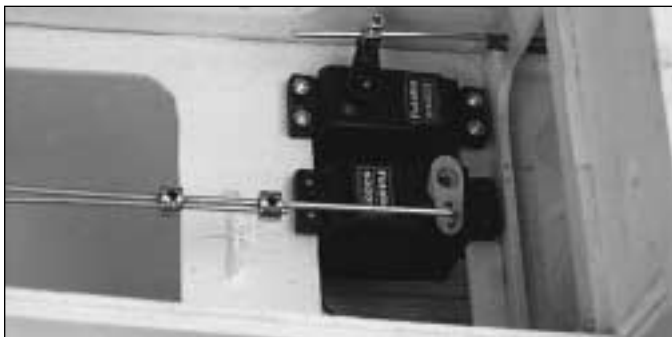

9. While keeping both elevators centered, connect the two elevator pushrods to each other with the two 5/32" wheel collars and 6-32 x 1/4" set screws as shown in the photo. We recommend using thread locking compound on the set screw threads.

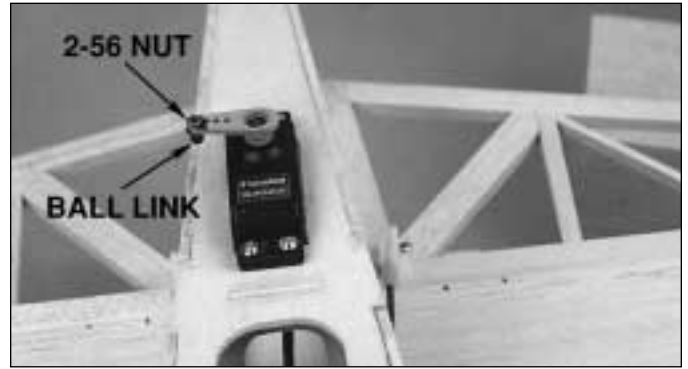

10. Mount the rudder servo in the fuse as shown. Mount the 2-56 ball link to the rudder servo arm with the 2-56 nut provided. The ball link must extend toward the fuse as shown. Secure the nut with thread locker or thin CA.

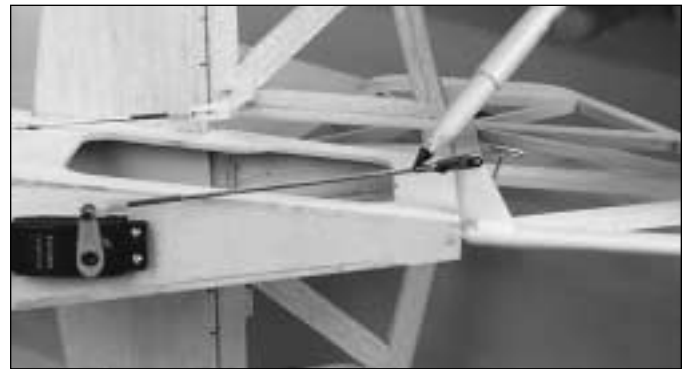

11. Cut 1-1/4" off the unthreaded end of the 6" rudder pushrod, making a final length of 4-3/4". Screw the nylon ball link socket fifteen turns onto the rudder pushrod. Snap the ball link onto the ball on the servo arm. Temporarily slide the solder clevis onto the rudder control horn and fit it in place on the rudder with the rudder pushrod inserted into the clevis. Center the rudder and the servo horn and mark the pushrod with a felt tip pen where it enters the clevis.



12. Remove the solder clevis from the control horn, and remove the servo arm from the servo with the pushrod attached. The pushrod must be cleaned (but don't wipe off your mark) before soldering. Rubbing alcohol works well for this. Silver solder the clevis to the pushrod using the mark you made as a reference.



❑ 13. Reattach the servo arm with the pushrod to the servo. Mount the control horn the same way as the elevators with two 2-56 x 5/8" screws.

❑ 14. Mark the location of the **tail gear wire** on the rudder and the nylon tail gear bearing on the fuselage.

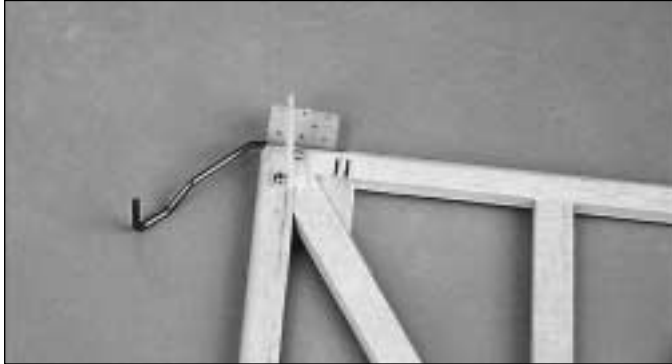

❑ 15. Remove the rudder and drill a 7/64" hole 5/8" deep in the leading edge at the mark you made for the tail gear wire. Cut a groove in the rudder for the nylon tail gear bearing (use a 5/32" brass tube sharpened at one end to cut the groove the same way you did for the ailerons). Test fit the tail gear wire in the rudder.



❑ 16. Cut a slot in the trailing edge of the fuse at the marks you made for the nylon tail gear bearing. Without using any glue, join the rudder to the fin with the tail gear wire.

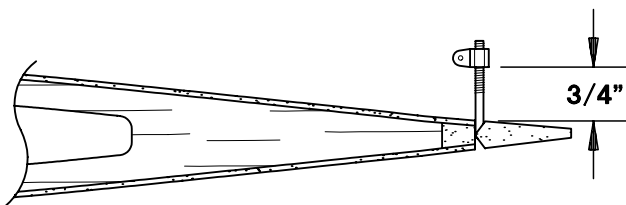

❑ 17. Mount the aileron servo in the wing. Screw the nylon **torque rod connectors** on the torque rods until they are 3/4" from the wing.

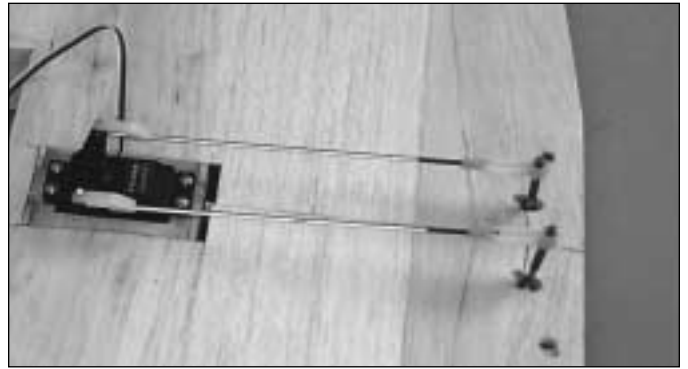

❑ 18. Use the 11" and 13" wire rods cut from the 35" pushrods to make the aileron pushrods. Connect the pushrods the same way you did for the elevator with the nylon clevises and Faslinks.

### Add the Forward & Aft Wing Fairings

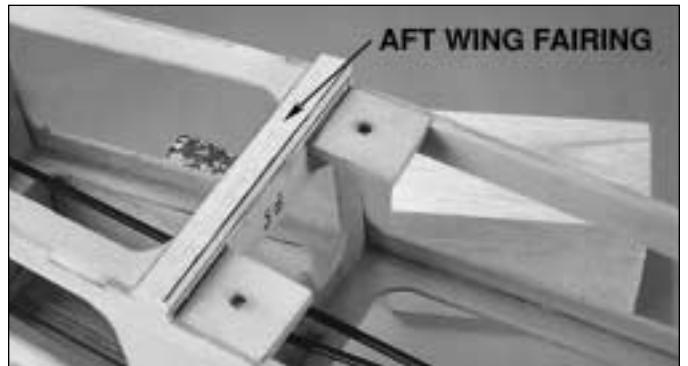

❑ 1. Using a leftover 1/4" x 1/2" balsa stick, make the forward and the aft wing fairings, and glue them in place. Sand the fairings flush with the sides of the fuse.

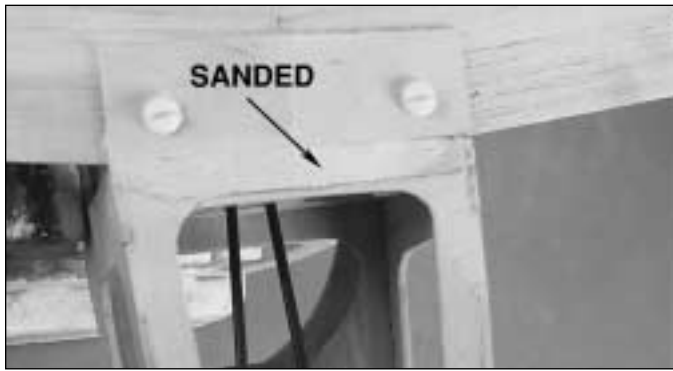

□ □ 2. Mount the wing to the fuse. Using your sanding bar, shape the fairings to the contour of the wing. Be careful not to sand into the wing.

**Note:** It is easier to sand one side of the aft fairing with one wing bolt removed. When the first side is done, put the wing bolt back in place and remove the wing bolt on the unsanded side.

### Assemble the Wheel Pants



□ □ 1. Trim one matching set of wheel pant halves along the molded in cut lines. Notice that the **top** of the outer pant goes over the lip of the inner pant and the **bottom** of the inner pant goes over the lip of the outer pant. You can use a hobby knife to **carefully** score along the cut lines and flex the plastic until the excess breaks free, or use small scissors to cut along the lines. Kyosho curved plastic cutting scissors (KYOR1010) work extremely well for this and make the job a cinch. For now, don't worry about accurately cutting out the opening in each wheel pant half—just cut an approximate opening for the wheels.



□ □ 2. Use your bar sander to carefully true the edges of the overlapping pieces of the wheel pant halves so when you glue them together the seam will be as small and straight as possible. Notice that the front and rear of the pant halves do not overlap and are "butt glued" together. Use 150 or 220-grit sandpaper to remove the flashing and **thoroughly** roughen all areas that are to be glued including the indentation on the inside of both inner pant halves.

□ □ 3. Test fit the wheel pant halves and make adjustments where necessary for the best possible fit.

□ □ 4. Join two wheel pant halves and carefully spot glue them together in just a few places with thin CA. Start by spot gluing the top, then the front and rear where the two halves just butt together. After the halves are joined, securely glue them together along all seams with thin CA.

**Note:** Do not use CA accelerator on the ABS plastic as it may develop cracks and/or keep the paint from adhering.

□ □ 5. Use your hobby knife (or a Moto-Tool with a sanding drum) to cut out the wheel openings.

**Hint:** Make the wheel openings wide as this will make installing the wheels and axles easier and cause less interference with the wheels upon landing and takeoff. You can see the size of the wheel openings in the following photo.

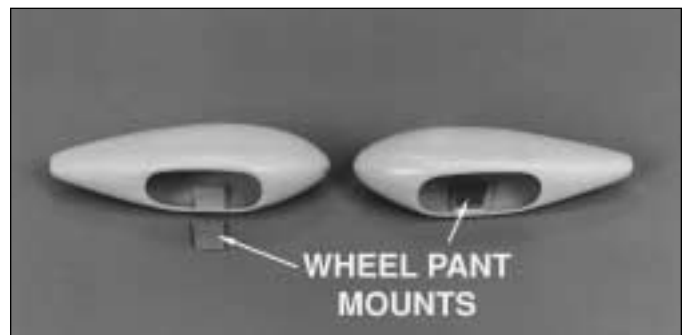

□ □ 6. Use medium CA to glue the die-cut 1/8" plywood wheel pant mounts to the inside of each wheel pant.



□ □ 7. Use a metal file to chamfer the edges and corners of the aluminum landing gear so it will neatly fit in the recess of the wheel pant. Position the wheel pant on the aluminum landing gear, then use a felt tip pen to accurately mark the location of the axle mounting hole.



☐ ☐ 8. Drill a 3/16" (11/64" or #18 for precision) hole in the wheel pant at the mark. Back up the wheel pant mount with a piece of scrap wood so you do not split it as the drill goes through.

☐ ☐ 9. Most 2-1/2" wheels are made to fit 5/32" axles, but the 8-32 screws supplied in this kit for the axles require a larger hole. If the wheel does not roll freely on the 8-32 x 1-1/2" SHCS "axle," enlarge the wheel hub with an 11/64" (#18 for perfection) drill.

☐ ☐ 10. Test fit the wheel in the wheel pant using the following procedure:



A. Install an axle in a wheel. Thread an 8-32 nut about 1/8" onto the axle.



B. Insert the wheel in the pant with the end of the screw inserted in the plywood wheel pant mount and the head of the screw sticking out of the wheel pant.

**Note:** When you reinstall the wheel after the wheel pant has been painted, put masking tape on the bottom of the pant so the screw will not scratch it.



C. Use a 9/64" hex wrench to screw the axle through the wheel and the wheel pant until the wheel goes all the way in and the axle goes through the pant mount.

D. Adjust the tightness of the nut with hemostats or needle nose pliers.

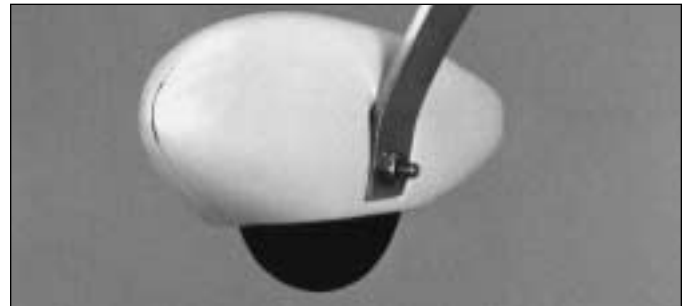

☐ ☐ 11. Temporarily mount the wheel pant to the landing gear with another 8-32 nut on the axle.

☐ 12. Perform the same procedure to assemble and temporarily mount the other wheel pant to the landing gear.



☐ 13. Before painting the wheel pants, fill the seams with putty filler such as Squadron White Putty or resin filler such as Bondo.® We use Bondo most of the time as it cures quickly and is easy to sand, but usually it must be purchased in large quantities. Squadron putty works well but it takes overnight to dry and usually requires at least two applications because it shrinks as it dries.



☐ 14. After the filler cures, wet sand the wheel pants with 400-grit sandpaper to prepare them for primer.

## Assemble the Cowl

1. The cowl is assembled in a manner similar to the wheel pants. Cut the cowl along the cut lines, then use your bar sander to true all the edges. For now, the opening in the front cowl piece only needs to be roughly cut out. Use coarse sandpaper to roughen all the overlapping areas so the glue will stick.



2. Tape the three pieces together, then wick a small amount of thin CA along the seams of the overlapping joints. After the CA has cured, remove the tape and make sure you have thoroughly glued the two pieces together by inspecting the glue joints and adding thin CA if necessary.

3. Use a sharp hobby knife (or a Moto-Tool with a sanding drum) to accurately cut the air openings at the front of the cowl and the air exit at the bottom rear of the cowl.

4. Use 30-minute epoxy to glue a 1" strip of fiberglass cloth across the glue joint inside the front of the cowl.



5. Fit the cowl over the engine, then mount the spinner backplate on the engine. Align the cowl so there is approximately a 1/8" gap between the backplate of the spinner and the cowl. Tape the cowl to the fuse.



6. Making one hole at a time and checking to be sure the cowl still lines up with the spinner back plate, drill one 3/32" hole through the cowl and the fuse side at one of the locations shown on the plan. Using a #4 x 1/2" screw attach the cowl to the fuse. Do the same for the other three cowl mounting screws, checking alignment before drilling each one.

7. Remove the spinner backplate and the cowl from the fuselage. Use a drop of thin CA to harden the screw holes in the fuse.



8. Use thin cardboard or plastic to make templates for the cutouts in the cowl for the glow plug driver and the needle valve. Tape the templates to the fuselage behind where the cowl will mount to the fuse, accurately indicating the position of the glow plug and needle valve.



- ❑ 9. Remount the cowl, leaving the templates you made attached to the fuse. Mark the holes for the needle valve and the glow plug driver on the cowl. Remove the cowl and cut the holes for the needle valve and glow plug driver.
- ❑ 10. Cut four 1" x 1" pieces of fiberglass cloth. Use 30-minute epoxy to glue one piece to the inside of the cowl at each cowl mounting hole. After the epoxy cures, re-drill the holes with a 1/8" drill bit.
- ❑ 11. Fill the seams and other imperfections in the cowl as described in the preceding **Wheel Pants** section. Wet sand the entire cowl with 400-grit sandpaper to prepare it for priming.

### **Prepare the Model for Covering**

- ❑ 1. Disconnect and remove all the pushrods and remove the hinges and control horns from the ailerons, elevators, and rudder. Remove the engine mount and any other hardware you may have installed.
- ❑ 2. Most of the model should be rough-sanded by now with all the tabs and rough edges sanded even. Fill all dents, seams, low spots, and notches with HobbyLite Balsa Colored Filler.
- ❑ 3. After the filler has dried, use progressively finer grades of sandpaper to even all the edges and seams and smooth all surfaces. Remove all balsa dust from the model with compressed air or a vacuum with a brush and a tack cloth.

## **COVER THE MODEL WITH MONOKOTE FILM**

### **Covering Technique**

Cover the model with **Top Flite MonoKote® Film** using the recommended covering sequence that follows. Before you cover the fuselage, first apply 1/4" wide strips of MonoKote film in the corners between the stab and fuse and the fin and

the fuse, then proceed to cover the fin and stab with pre-cut pieces that meet in the corners and overlap the 1/4" strips. **Never cut the covering on the stab and fin after it has been applied except around the leading and trailing edges and at the tips.** Modelers who do this may cut through the covering and into the stab or fin. This will weaken the structure to a point where it may fail during flight.

Since the tips of the elevators and stab are squared off it is easiest to cover the tips before you cover the tops and bottoms. Do the same for the fin, rudder and the wing.

Some modelers drill a small hole in each elevator rib and the trailing edge of the elevators to allow expanded gas to exit while heating the MonoKote film. This keeps the covering from "ballooning" and allows you to securely bond it to the entire elevator. The same thing can be done with the fin and rudder.

Since the ailerons are long "strip" ailerons, some modelers prefer to cover the top and bottom with one strip of MonoKote film by covering the bottom first, then wrapping it around the leading edge and over the top.

### **Suggested Covering Sequence**

#### **Fuselage**

1. 1/4" strips at fin and stab as described
2. Aft fuse bottom
3. Forward fuse bottom
4. Fuse right side up to the top center of the turtledeck
5. Fuse left side up to the center of the turtledeck, overlapping by 1/8"
6. Forward fuse deck top
7. Fin tip, then stab tips
8. Stab bottom, then top
9. Fin right side, then left side
10. Elevator tips and root ends
11. Elevator bottoms, then tops
12. Rudder tip, right side, then left side
13. Cockpit - A light color is recommended for this so the heat build up under the canopy is kept to a minimum.

#### **Wing**

1. Wing root spacers
2. Wing tips
3. Trailing edges of wing and inboard portion of tips and center leading edges
4. Bottom of right, then left panel
5. Top of right, then left panel
6. Aileron tips, bottom, then top

## BALANCE THE MODEL Laterally

Do not confuse this procedure with "checking the C.G." which will be discussed later in the manual.

Now that the model is covered and nearly completed, this is the time to balance it laterally (side-to-side). Here's how:

❑ 1. With the wing level and attached to the model (and the engine and muffler installed), lift the model by the propeller shaft and the fin. This may require an assistant. Do this several times.

❑ 2. The wing that consistently drops indicates the heavy side. Balance the model by adding weight to the other wing tip.

An airplane that is laterally balanced will track better during aerobatic maneuvers.

## PAINTING

After the model is covered, use fuelproof model paint, 30-minute epoxy thinned with alcohol or finishing resin to coat areas that may be exposed to raw fuel or exhaust residue. These are areas such as the firewall, front and back of the fuse openings for the wing and wing saddle doubler, fuel compartment hatch and the fuse top forward of the sheeting.

Top Flite LustreKote™ fuel-proof paint is recommended for painting all the ABS plastic parts and the aluminum landing gear. The wheel pants should be removed from the landing gear for painting. Use a file to round the corners of the aluminum landing gear before you paint it. At least one coat of LustreKote primer is highly recommended to fill all the small scratches left from sanding as well as small pin holes in the Bondo filler. **Wet sand** between coats with 400-grit sandpaper and apply a second coat of primer if necessary.

Before painting the canopy, use scissors or a hobby knife to trim it along the molded-in cut lines, then true the edges with your bar sander and 220-grit sandpaper. Use 400-grit sandpaper to scuff the frame portion of the canopy so the paint will stick. We recommend you paint the canopy frame with Pactra Formula-U or Chevron Perfect Paint. Use masking tape to cover the portion of the canopy that is not to be painted. If you are not sure that the paint is compatible with the clear canopy, test the paint on a scrap piece of canopy material.

For painting the pilot, we have discovered that acrylic water base paints such as the types found at craft stores work great. The acrylic paints look realistic on the pilot because they are not glossy, and best of all, they clean up with water.

## FINAL HOOKUPS & CHECKS

### Join the Control Surfaces

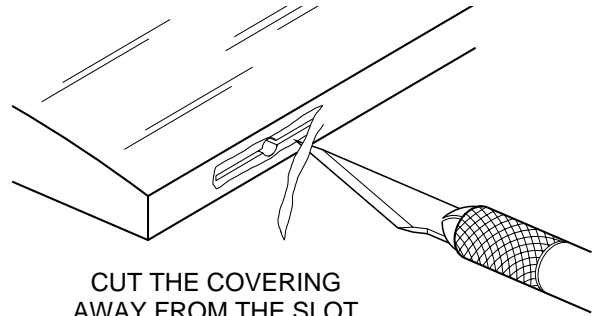

CUT THE COVERING AWAY FROM THE SLOT

❑ 1. Start with the elevators and stab. Cut the covering from the hinge slots—don't just *slit* the covering but remove a small strip the size of the hinge slot.

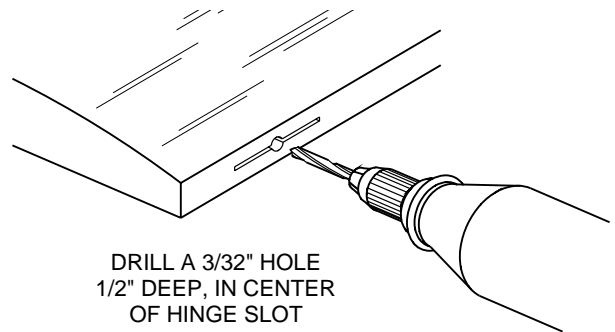

DRILL A 3/32" HOLE 1/2" DEEP, IN CENTER OF HINGE SLOT

❑ 2. Drill a 3/32" hole 1/2" deep in the center of each hinge slot. A high speed moto-tool works best for this. If you use a regular drill, clean out the hinge slots with your #11 blade.

❑ 3. Clean the aileron torque rod arms and the tail gear wire with rubbing alcohol to remove residue that may keep the glue from sticking. Use coarse sandpaper to scuff the tail gear wire and the aileron torque rods so the glue will stick.

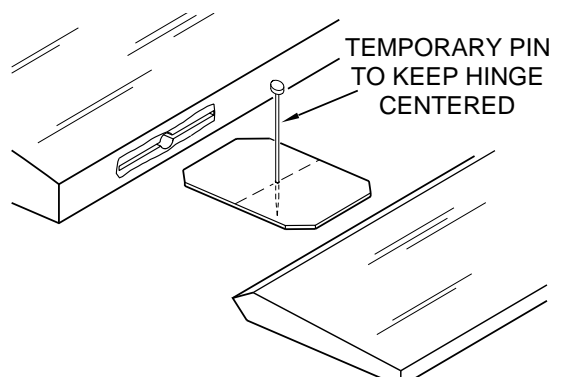

TEMPORARY PIN TO KEEP HINGE CENTERED

❑ 4. Without using any glue, fit the hinges in the elevators or stab. **Do not glue the hinges yet.** As you join the elevators to the stab, confirm that the hinges are equally inserted in the elevators and the stab. Insert a small pin in the center of the hinges to keep them centered.

ASSEMBLE, THEN APPLY 6 DROPS  
OF THIN CA TO CENTER  
OF HINGE, ON BOTH SIDES

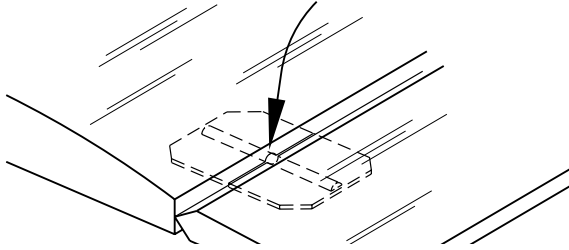

THE CA WICKS  
ALONG THE "TUNNELS"  
TO THE ENTIRE  
HINGE SURFACE

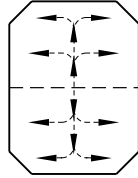

- ❑ 5. Remove the pin and add 6 drops of thin CA to the center of all the hinges on both the top and the bottom.

**Do not use accelerator on any of the hinges. Do not glue the hinges with anything but thin CA and do not attempt to glue one half of the hinge at a time with medium or thick CA. They will not be properly secured and the controls could separate while the model is in flight.**

- ❑ 6. Join the rudder to the fin with the hinges and use 30-minute epoxy to simultaneously glue the tail gear wire in the rudder and the tail gear bearing in the fuse. **Do not glue the nylon bearing to the rudder.** Glue the hinges in position with thin CA.

**Hint:** Applying a little petroleum jelly to the tail gear wire where it passes through the nylon bearing will prevent the wire from being glued into the bearing.

- ❑ 7. Prepare the hinge slots in the ailerons the same way you did for the tail surfaces.

- ❑ 8. Use a toothpick to pack the torque rod holes in the ailerons with 30-minute epoxy, then join the ailerons to the wing with the hinges. Glue the hinges with thin CA. Wipe away the epoxy that is squeezed out of the ailerons with a paper towel and alcohol.

## Install the Hardware

- ❑ 1. Install a 1" tail wheel with two 3/32" wheel collars.
- ❑ 2. Install the wheels in the wheel pants (don't forget the masking tape so the screw doesn't scratch the paint), then mount the wheel pants to the landing gear. Secure the 8-32 nuts with a drop of thread lock.
- ❑ 3. Mount the landing gear to the fuselage with the 8-32 x 3/4" socket head cap screws and #8 washers.

- ❑ 4. Install the elevator, rudder and throttle pushrods and servos. Install the control horns and hook them up the same way you did earlier.



- ❑ 5. Using four #2 x 3/8 screws, mount the receiver tray to the fuse with the receiver still attached.

- ❑ 6. Mount the receiver switch in a convenient location that will not interfere with the servos and pushrods inside the fuselage.

- ❑ 7. Route the receiver antenna. On our prototype we drilled a small hole in the bottom of the fuse aft of the wing bolt plate and inserted a piece of tubing to route the antenna through (fuel tubing or neoprene retractable landing gear air tubing works well). Make a strain relief from a cut-off servo arm and place it on the antenna near the receiver as shown on the plan. Route the antenna through the tubing. Make a hook out of another cut-off servo arm and loop the end of the antenna to it. Connect the servo arm hook to a rubber band and loop it around the tail gear wire.

- ❑ 8. Some modelers prefer to cushion the wing with wing seating foam tape on the wing saddle of the fuselage. Apply 1/16" seating tape on the wing saddle of the fuselage if you choose.

- ❑ 9. Prepare the engine compartment for installing the cowl by connecting the fuel lines, installing the fueling valve, mounting the muffler, and connecting the throttle pushrod. Install the cowl, then mount the spinner backplate, prop, prop washer, and prop nut. Install the spinner.

## Attach the Canopy

- ❑ 1. Place the canopy on the fuselage at the location shown on the plan. Temporarily hold it in position with tape or rubber bands.
- ❑ 2. Use a felt tip pen to **accurately** trace the canopy outline onto the MonoKote film covering. Remove the canopy.

## REMOVE THE COVERING



❑ 3. Use a sharp #11 blade to **carefully** cut the covering about 1/32" inside of the line you marked **without cutting into the balsa**. Wipe away the ink line with a paper towel lightly dampened with rubbing alcohol.

❑ 4. Before you permanently glue the canopy to the fuselage, securely glue your pilot in place. For the most security, screw the base of the pilot to the cockpit floor with two #4 or #6 sheet metal screws from the underside of the cockpit floor. Place the instrument panel decal on the instrument panel.

❑ 5. Reposition the canopy on the fuselage and confirm that it covers the exposed wood. Glue the canopy to the fuselage using rubber bands or masking tape to hold it in position until the glue dries. We recommend a glue specifically formulated for gluing on canopies, such as Pacer "Formula 560" canopy glue. Formula 560 is like regular white glue (aliphatic resin) in that it dries clear and cleans-up with water, but it sticks extremely well to butyrate and dries overnight (to allow for accurate positioning).

## Set the Control Throws

### 4-CHANNEL RADIO SETUP (STANDARD MODE 2)

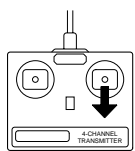

ELEVATOR MOVES UP

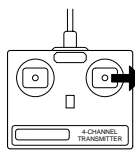

RIGHT AILERON MOVES UP  
LEFT AILERON MOVES DOWN

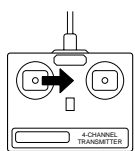

RUDDER MOVES RIGHT

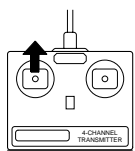

CARBURETOR WIDE OPEN

## We recommend the following control surface throws:

**NOTE:** The throws are measured at the **widest part** of the elevators, rudder, and ailerons. Adjust the position of the pushrods at the control/servo horns to control the amount of throw. You may also use the ATV's if your transmitter has them but the mechanical linkages should still be set so the ATV's are near 100% for the best servo resolution (smoothest, most proportional movement).

	High Rate	Low Rate
<b>ELEVATOR:</b>	1" up 1" down	5/8" up 5/8" down
<b>RUDDER:</b>	3" right 3" left	1-3/4" right 1-3/4" left
<b>AILERONS:</b>	3/8" up 3/8" down	1/4" up 1/4" down

**NOTE:** If your radio does not have dual rates, then set the control surfaces to move at the **low rate** throws.

**NOTE:** The balance and control throws for the CAP 232 have been extensively tested. We are confident that they represent the settings at which the CAP 232 flies best. Please set up your model to the specifications listed above. If, after you become comfortable with your CAP 232, you would like to adjust the throws to suit your tastes, that's fine. Too much throw can force the plane into a stall or snap, so remember, "more is not better." Trust the low rates.

## Balance the Model

**NOTE:** This section is **VERY** important and must **NOT** be omitted! A model that is not properly balanced will be unstable and possibly unflyable.

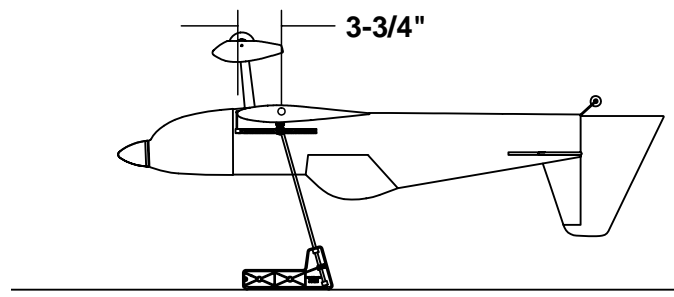

❑ 1. Accurately mark the balance point on the **top** of the wing on both sides of the fuselage. Use thin strips of tape



or a felt tip pen to make the marks. The balance point (**CG**) is located **3-3/4" back from the leading edge** as shown in the sketch and on the fuselage plan.

**Hint:** Reference the full size fuse plan to help you locate the proper balance point. This is the balance point at which your model should balance for your first flights. After initial trim flights and when you become more acquainted with your CAP 232, you may wish to experiment by shifting the balance up to **1/4" forward or back** to change the flying characteristics. Moving the balance **forward** may improve the smoothness and stability, but the model may then require more speed for takeoff and it may be more difficult to slow for landing. Moving the balance **aft** makes the model **more agile** with a lighter, snappier "feel" and often improves knife-edge capabilities. In any case, **please start at the location we recommend and do not at any time balance your model outside the recommended range.**

**Hint:** *The Great Planes CG Machine™ makes this process much easier and more accurate.*

□ 2. With the wing attached to the fuselage, all parts of the model installed (ready to fly) and an **empty** fuel tank, hold the model upside-down with the stabilizer level.

□ 3. Lift the model at the balance point. If the **tail** drops when you lift, the model is "tail heavy" and you must add weight\* to the nose to balance the model. If the **nose** drops, it is "nose heavy" and you must add weight\* to the tail to balance the model.

**NOTE:** Nose weight may be easily installed by using a "spinner weight" or gluing lead weights to the firewall. Tail weight may be added by using Great Planes (GPMQ4485) "stick-on" lead weights. Later, if the balance is OKAY, you can open the fuse bottom and glue the weights in permanently.

*\* If possible, first attempt to balance the model by changing the position of the receiver battery and receiver. If you are unable to obtain good balance by doing so, then it will be necessary to add weight to the nose or tail to achieve the proper balance point.*

## PREFLIGHT

At this time, check all connections including servo arm screws, Faslinks, clevises and servo wires. Make sure you have installed the **nylon retainer** on the screw-lock pushrod connector on the throttle pushrod at the servo arm, and the **silicone retainers** on all the clevises.

## Charge the Batteries

Follow the battery charging procedures in your radio instruction manual. You should **always** charge your transmitter and receiver batteries the night before you go flying, and at other times as recommended by the radio manufacturer.

## Balance the Propeller

Balance your propellers carefully before flying. An unbalanced prop is the single most significant cause of vibration. Not only may engine mounting screws vibrate out, possibly with disastrous effect, but vibration may also damage your radio receiver and battery. Vibration may cause your fuel to foam, which will, in turn, cause your engine to run lean or quit.



We use a **Top Flite Precision Magnetic Prop Balancer™** (TOPQ5700) in the workshop and keep a **Great Planes Fingertip Balancer** (GPMQ5000) in our flight box.

## Find a Safe Place to Fly

Since you have chosen the CAP 232 we assume that you are an experienced modeler. Therefore, you should already know about AMA chartered flying fields and other safe places to fly. If, for some reason you are a relatively inexperienced modeler, and have not been informed, we strongly suggest that the best place to fly is an AMA chartered club field. Ask the AMA or your local hobby dealer if there is a club in your area and join. Club fields are set up for R/C flying and that makes your outing safer and more enjoyable. The AMA address and telephone number are in the front of this manual.

If a club and flying site are not available, find a large, grassy area at least 6 miles away from houses, buildings and streets and any other R/C radio operation like R/C boats and R/C cars. A schoolyard may look inviting but is too close to people, power lines and possible radio interference.

## Ground Check the Model

If you are not thoroughly familiar with the operation of R/C models, ask an experienced modeler to inspect your radio installation and confirm that all the control surfaces respond correctly to transmitter inputs. The engine operation must also be checked by confirming that the engine idles reliably and transitions smoothly and rapidly to

full power, and maintains full power indefinitely. The engine must be "broken-in" on the ground by running it for at least two tanks of fuel. **Follow the engine manufacturer's recommendations for break-in.** Make sure all screws remain tight, that the hinges are secure and that the prop is on tight.

### ***Range Check the Radio***

Whenever you go to the flying field, check the operational range of the radio before the first flight of the day. First, make sure no one else is on your frequency (channel). With your transmitter antenna collapsed and the receiver and transmitter on, you should be able to walk at least 100 feet away from the model and still have control. While you work the controls have a helper stand by your model and tell you what the control surfaces are doing.

Repeat this test **with the engine running** at various speeds with a helper holding the model. If the control surfaces are not always responding correctly, **do not fly!** Find and correct the problem first. Look for loose servo connections or corrosion, loose bolts that may cause vibration, a defective on/off switch, low battery voltage or a defective cell, a damaged receiver antenna, or a receiver crystal that may have been damaged from a previous crash.

### ***Engine Safety Precautions***

**NOTE: Failure to follow these safety precautions may result in severe injury to yourself and others.**

Keep all engine fuel in a safe place, away from high heat, sparks or flames as fuel is very flammable. Do not smoke near the engine or fuel; and remember that the engine exhaust gives off a great deal of deadly carbon monoxide. **Do not run the engine in a closed room or garage.**

Get help from an experienced pilot when learning to operate engines.

Use safety glasses when starting or running engines.

Do not run the engine in an area of loose gravel or sand; the propeller may throw such material in your face or eyes.

Keep your face and body as well as all spectators away from the plane of rotation of the propeller as you start and run the engine.

Keep these items away from the prop: loose clothing, shirt sleeves, ties, scarfs, long hair or loose objects such as pencils, screw drivers that may fall out of shirt or jacket pockets into the prop.

Use a "chicken stick" or electric starter; follow instructions supplied with the starter or stick. Make certain the glow plug clip or connector is secure so that it will not pop off or otherwise get into the running propeller.

Make all engine adjustments from **behind** the rotating propeller.

The engine gets hot! Do not touch it during or after operation. Make sure fuel lines are in good condition so fuel will not leak onto a hot engine causing a fire.

To stop the engine, cut off the fuel supply by closing off the fuel line or follow the engine manufacturer's recommendations. Do not use hands, fingers or any body part to try to stop the engine. Do not throw anything into the prop of a running engine.

### ***AMA Safety Code (excerpt)***

Read and abide by the following Academy of Model Aeronautics Official Safety Code:

#### **General**

1. I will not fly my model aircraft in sanctioned events, air shows, or model flying demonstrations until it has been proven to be airworthy by having been previously successfully flight tested.
2. I will not fly my model aircraft higher than approximately 400 feet within 3 miles of an airport without notifying the airport operator. I will give right of way to, and avoid flying in the proximity of, full scale aircraft. Where necessary an observer shall be used to supervise flying to avoid having models fly in the proximity of full scale aircraft.
3. Where established, I will abide by the safety rules for the flying site I use, and I will not willfully and deliberately fly my models in a careless, reckless and/or dangerous manner.
7. I will not fly my model unless it is identified with my name and address or AMA number, on or in the model.
9. I will not operate models with pyrotechnics (any device that explodes, burns, or propels a projectile of any kind)

#### **Radio control**

1. I will have completed a successful radio equipment ground check before the first flight of a new or repaired model.
2. I will not fly my model aircraft in the presence of spectators until I become a qualified flier, unless assisted by an experienced helper.

3. I will perform my initial turn after takeoff away from the pit or spectator areas, and I will not thereafter fly over pit or spectator areas, unless beyond my control.

4. I will operate my model using only radio control frequencies currently allowed by the Federal Communications Commission.

## FLYING

**CAUTION (THIS APPLIES TO ALL R/C AIRPLANES):** If, while flying, you notice any unusual sounds, such as a low-pitched "buzz", this may indicate control surface "flutter". Because flutter can quickly destroy components of your airplane, any time you detect flutter you must **immediately** cut the throttle and land the airplane! Check all servo grommets for deterioration (this may indicate which surface fluttered), and make sure all pushrod linkages are slop-free. If it fluttered once, it will probably flutter again under similar circumstances unless you can eliminate the slop or flexing in the linkages. Here are some things which can result in flutter: Excessive hinge gap; Not mounting control horns solidly; Sloppy fit of clevis pin in horn; Elasticity present in flexible plastic pushrods; Side-play of pushrod in guide tube caused by tight bends; Sloppy fit of Z-bend in servo arm; Insufficient glue used when gluing in the elevator joiner wire or aileron torque rod; Excessive flexing of aileron, caused by using too soft balsa; Excessive "play" or "backlash" in servo gears; and Insecure servo mounting.

The Great Planes CAP 232 is a great flying semi-scale sport model that flies smoothly and predictably, yet is highly aerobatic. Compared to other sport planes its flight characteristics are docile and forgiving. The CAP does not, however, possess the self-recovery characteristics of a primary R/C trainer; therefore, you must either have mastered the basics of R/C flying or obtained the assistance of a competent R/C pilot to assist you with the first flights of your CAP 232.

## Takeoff

Take off on "low" rates if you have dual rates on your transmitter. For all models it is good practice to gain as much speed as the length of the runway will permit before lifting off. This will give you a safety margin in case the engine quits. When you initially advance the throttle and the tail begins to lift, the CAP will begin to turn to the left slightly (due to the torque of the engine—a characteristic of all taildraggers). Be prepared for this by applying sufficient right rudder to keep the CAP running straight down the middle of the runway (or flying field). The left turning

tendency will decrease as the plane picks up speed. Be sure to allow the tail to rise off the ground before lifting the model into the air. Depending on the surface you are taking off from, you will need to apply little or no up elevator until flying speed is reached. Don't hold the tail on the ground with too much up elevator, as the CAP will become airborne prematurely and may stall. When the plane has gained enough flying speed to safely lift off, gradually and smoothly apply up elevator and allow the model to climb at a shallow angle (do not yank the model off the ground into a steep climb!).

## Flight

We recommend that you take it easy with your CAP 232 for the first several flights, gradually "getting acquainted" with this great sport model as your engine gets fully broken in. If you feel as though you have your hands full, keep this one thing in mind: **pull back on the throttle stick to slow the model down.** This will make everything happen a little slower and allow you time to think and react. Add and practice one maneuver at a time, learning how the CAP behaves in each. For smooth flying and normal maneuvers, use the low rate settings as listed on page 40. For good knife-edge performance forward flight speed is the key. Snaps are best performed on low rate, as the high rate tends to push the CAP too deep into the stall slowing the exit of the snap.

Sometime well before it's time to land you should climb your CAP to a safe altitude and cut the throttle to an idle to check out the model's slow speed characteristics. Do this a few times so you know what to expect upon landing.

## Landing

When it's time to land, fly a normal landing pattern and approach. Keep a few clicks of power on until you are over the runway threshold. For your first few landings, plan to land slightly faster than stall speed and on the main wheels, as this is the easiest way to land your CAP. Later, with a little practice, you will find you can make slow 3-point landings.

**Have a ball! But always remember to think about your next move and plan each maneuver before you do it. Impulsively "jamming the sticks" without any thought is what gets most fliers in trouble rather than lack of flying skill.**

## 2-VIEW DRAWING

Use this layout for trim scheme planning only. Not suitable for scale documentation.

