



## INSTRUCTION MANUAL



### WARRANTY

Great Planes Model Manufacturing Co. guarantees this kit to be free from defects in both material and workmanship at the date of purchase. This warranty does not cover any component parts damaged by use or modification. **In no case shall Great Planes' liability exceed the original cost of the purchased kit.** Further, Great Planes reserves the right to change or modify this warranty without notice.

In that Great Planes has no control over the final assembly or material used for final assembly, no liability shall be assumed nor accepted for any damage resulting from the use by the user of the final user-assembled product. By the act of using the user-assembled product, the user accepts all resulting liability.

**If the buyers are not prepared to accept the liability associated with the use of this product, they are advised to return this kit immediately in new and unused condition to the place of purchase.**

**READ THROUGH THIS INSTRUCTION MANUAL FIRST. IT CONTAINS IMPORTANT INSTRUCTIONS AND WARNINGS CONCERNING THE ASSEMBLY AND USE OF THIS MODEL.**



P.O. Box 788 Urbana, IL 61801 (217) 398-8970  
productsupport@greatplanes.com

## TABLE OF CONTENTS

INTRODUCTION	2
SAFETY PRECAUTIONS	2
DECISIONS YOU MUST MAKE	3
Radio Equipment	3
Speed Control	3
Motor System	3
Battery Recommendations	3
Chargers	4
Covering	4
Building Board	4
ADDITIONAL ITEMS REQUIRED	4
Building Supplies	4
Optional Supplies and Tools	5
IMPORTANT BUILDING NOTES	5
Patterns	6
Metric Conversions	6
Metric/Inch Scale	6
BUILD THE TAIL SURFACES	7
Build the Fin & Rudder	7
Build the Stabilizer & Elevator	8
BUILD THE WING	9
Build the Wing Panels	9
Join the Wing Panels	11
BUILD THE FUSELAGE	12
Assemble the Fuselage Sides	12
FINISHING	14
Final Sanding	14
Covering the Model	14
Add Washout	14
COMPLETING ASSEMBLY	15
Mount the Stabilizer & Fin	15
RADIO INSTALLATION	16
Mount the Servos	16
ASSEMBLE THE GEAR DRIVE	16
MOUNT THE MOTOR	17
INSTALL THE PUSHRODS	17
INSTALL THE LANDING GEAR	19
SET THE CONTROL THROWS	19
BALANCE YOUR MODEL	19
PREFLIGHT	20
Charge the Transmitter Batteries	20
Identify Your Model	20
Ground Inspection	20
Range Check	20
PERFORMANCE TIPS	20
Cycle the Batteries	20
Examine the Propeller	21
Motor Care	21
Oil the Wheels	21
Motor Safety Precautions	21
AMA Safety Code	21
Find a Safe Place to Fly	21
FLYING	22
Takeoff	22
Flight	22
Landing	23
ROG Takeoff	23
2-VIEW DRAWING	back cover

## INTRODUCTION

Congratulations and thank you for purchasing the **Great Planes Basic Light Trainer (BLT)**. The *BLT* is one in a series of **Park Flyers** from Great Planes designed to be flown in small areas. Park Flyers are a relatively new class of small, lightweight, slow-flying, fast-building models. Since Park Flyers are small and fly slowly, little space is required. A nearby park, schoolyard or vacant lot becomes an impromptu flying site (see **Find a Safe Place to Fly** on page 21). Additionally, Park Flyers are perfect for those evenings at the field when everybody else is packing up their gear, the wind has died, and there is still enough light to fly a small, slow model.

The BLT is a slow flying, high-wing model that is about as simple to build as they get. However, if you have never flown an R/C model before, learning to fly the BLT all by yourself is not recommended. As with any trainer airplane, you should find an experienced modeler to help you with your first flights. Information about R/C clubs and instructors is provided later in this manual.

### PROTECT YOUR MODEL, YOURSELF & OTHERS... FOLLOW THESE IMPORTANT SAFETY PRECAUTIONS

1. Even though the **Great Planes BLT** is small, lightweight and flies slowly, if it is not assembled and operated correctly it could possibly cause injury to yourself or spectators and damage property.
2. Build the plane according to the plans and instructions. Do not alter or modify the model, as doing so may result in an unsafe or unflyable model. In a few cases the instructions may differ slightly from the photos. In those instances the plans and written instructions should be considered as correct.
3. Take time to build straight, true and strong.
4. Use an R/C radio system that is in first-class condition. This Park Flyer requires micro servos, a micro receiver and a micro speed control able to handle 5 amps.
5. You must properly install all R/C and other components so that the model operates properly on the ground and in the air.
6. You must test the operation of the model before **every** flight to insure that all equipment is operating, and that the model has remained structurally sound. Be sure to check connectors often and replace them if they show signs of wear or fatigue.

**NOTE:** We, as the kit manufacturer, provide you with a top quality kit and great instructions, but ultimately the quality of your finished model depends on how **you** build it; therefore, we cannot in any way guarantee the performance of your completed model, and no representations are expressed or implied as to the performance or safety of your completed model.

**Remember: Take your time and follow directions to end up with a well-built model that is straight and true.**

**If you're an inexperienced modeler, we recommend that you get assistance from an experienced, knowledgeable modeler to help you with assembly and your first flights.** You'll learn faster and avoid risking your model before you're truly ready to solo. Your local hobby shop has information about flying clubs in your area whose membership includes qualified instructors.

You can also contact the national Academy of Model Aeronautics (AMA), which has more than 2,500 chartered clubs across the country. Through any one of them, instructor training programs and insured newcomer training are available.

Contact the AMA at the address or toll-free phone number below.



**Academy of Model Aeronautics**

5151 East Memorial Drive

Muncie, IN 47302-9252

Tele. (800) 435-9262

Fax (765) 741-0057

or via the Internet at <http://www.modelaircraft.org>

**Please inspect all parts carefully before starting to build! If any parts are missing, broken or defective, or if you have any questions about building or flying this airplane, please call us at:**

**(217) 398-8970**

**or e-mail us at:**

**[productsupport@greatplanes.com](mailto:productsupport@greatplanes.com)**

**If you are calling for replacement parts, please reference the part numbers and the kit number and have them ready when calling.**

## **DECISIONS YOU MUST MAKE**

This is a list of items required to finish the BLT that must be purchased separately. For some of these items there is more than one option which will require a bit of decision making ahead of time. Order numbers (in parentheses) are provided for your convenience.

### **Radio Equipment**

The BLT requires a micro receiver and two micro servos. Futaba® S3103 (FUTM0037) or Hobbico® CS-5 (HCAM0090) micro servos are suitable.

### **Speed Control**

An electronic speed control with BEC (Battery Eliminator Circuitry) is required. The BEC allows both the motor and the radio system to be powered by the same battery (thus eliminating an additional battery typically required to power the radio). The Great Planes ElectriFly™ C-5 Nano High Frequency Electronic Speed Control (GPMM2000) is recommended for the BLT. If you purchase the complete motor and gear drive system, the speed control is included (refer to the “**Motor System**” section that follows).

### **Motor System**

The BLT is designed to use the Great Planes ElectriFly T-280GD ESC motor system and gear drive for electric flight (GPMG0430). This system includes a T-280 Ferrite Motor, S-280 4.1:1 ratio gearbox, 3mm prop adapter, APC 10 x 4.7 Slow Fly propeller and the ElectriFly C-5 Nano High Frequency Electronic Speed Control w/BEC. The same components are also available without the speed control by ordering number GPMG0445.

### **Battery recommendations**

There are mainly two kinds of battery packs used for electric R/C models; nickel-metal hydride (NiMh) packs, and nickel-cadmium (NiCd, pronounced *ny-cad*) packs. NiMh batteries are recommended for the BLT because they provide nearly twice the capacity of a NiCd for their size. However, it should be noted that nickel-metal hydrides cannot be charged as fast as NiCds.

Each individual cell that makes up a battery is 1.2 volts. Simply stated, a volt is the amount of *power* a battery pack can deliver (a 6-cell battery pack is 7.2 volts). Batteries are also rated by their capacity in mAh (milli-Amp-hours), or how much energy they store. A 550 mAh battery can supply 1 *Ampere* for .55 hours (about 30-minutes). A 1200 mAh battery pack is about twice the size of a 550 mAh battery pack. These are the battery packs recommended for the BLT:

**Panasonic 6-cell 550 mAh NiMh pack** (GPMP0100) for beginners due to its light weight.

**Panasonic 7-cell 550 mAh NiMh pack** (GPMP0101) for advanced pilots who are capable of flying in slightly windier conditions. (Continued on page 4)

**Panasonic 7-cell 1200 mAh NiMH** (GPMP0300) for advanced pilots requiring the longest duration (not recommended for beginners due to the fact that it is heavier than the 550 mAh batteries). **Note:** If flying the BLT at altitudes of 3,000 feet above sea level or higher, beginners should select the 7-cell 550 mAh battery pack, as the 6-cell pack may not provide adequate power.

**ATTENTION:** The product you have purchased is powered by a rechargeable battery. At the end of its useful life, under various state and local laws, it may be illegal to dispose of this battery into the municipal waste system. Check with your local solid waste officials for details in your area for recycling options or proper disposal.



**This product contains a chemical known to the State of California to cause cancer and birth defects or other reproductive harm.**

#### **Chargers**

The best type of charger to use is a *peak* charger, because it charges the batteries until they are fully charged, then automatically switches to a trickle charge mode. The Great Planes ElectriFly Peak Charger (GPMM3000) is suitable for nickel-metal hydride batteries, NiCds and transmitter battery packs.

If you have another type of charger that is not a peak charger, you will have to calculate the length of time it takes to charge the batteries yourself, then turn the charger off when the batteries are fully charged. Overcharging the batteries may damage them. Before you can calculate the time it takes to charge a battery pack, you first have to know the charge rate you are going to use. Nickel-metal hydrides must be charged at a rate of no more than 1/10 of their capacity. For the 550 mAh batteries recommended for the BLT, this would be a charge rate of approximately 50 mAh. Divide the capacity of the battery pack by the charge rate to calculate the charge time. A discharged 550 mAh battery pack charged at 50 mAh will take 11 hours to charge.

#### **Charge rate/time recommendations:**

Charge the 6-cell 550 mAh battery pack at 50 mAh for 11 hours.  
Charge the 7-cell 550 mAh battery pack at 50 mAh for 11 hours.  
Charge the 7-cell 1200 mAh battery pack at 100 mAh for 12 hours.

**IMPORTANT:** Monitor the temperature of the battery frequently. If the battery becomes warm, disconnect it from the charger.

A Hobbico R/C Multi-Charger (HCAP0100) is suitable for charging the battery packs used in the Park Flyers.

**Note:** The period required to charge the batteries in the examples above is for discharged batteries. If the battery you are going to charge is not discharged, connect it to the motor on your model. Run the motor until the propeller is turning slowly, thus discharging the battery.

#### **Covering**

There are several types of covering that may be used on the BLT, and a few that are not recommended. Use a covering suitable for lightweight models. Top Flite® EconoKote® and Coverite™ Micafilm are suitable for the BLT. EconoKote is similar to MonoKote (used on most regular-size sport models), except EconoKote is lighter and does not shrink as tightly, thus making it suitable for lightweight structures such as that of the BLT. EconoKote also has an adhesive on the back which is activated by the heat of a model airplane covering iron.

Coverite Micafilm is another covering suitable for lightweight structures. Micafilm has fibers imbedded in the film and is exceptionally strong, yet remains lightweight because it has no adhesive on the back. Therefore, you must apply an adhesive to the structure before application. Use Coverite Balsarite (COVR2500) for Micafilm. Do not use Balsarite “film formula” to apply Micafilm.

Transparent MonoKote film is also suitable for covering the BLT, because it is lighter and does not shrink as tightly as opaque MonoKote film (and is the covering that is on the model featured on the box label). Opaque MonoKote film is **not** recommended for the BLT because it is too heavy and shrinks too tightly for the structure to withstand the pressure.

#### **Building board**

You will need a flat board to lay over your workbench that you can stick pins into. The back of a 2' x 4' ceiling tile or a section cut from a sheet of Celotex insulation board is ideal.

## **ADDITIONAL ITEMS REQUIRED**

### **Building Supplies**

In addition to the equipment listed in the “**Decisions You Must Make**” section, following is the “short list” of the most important building supplies required to build the BLT. We recommend **Great Planes Pro™ CA and Epoxy glue**.

- 1/2 oz. Thin Pro CA (GPMR6001)
- 1/2 oz. Medium Pro CA+ (GPMR6007)
- Hobby knife (HCAR0105)
- #11 blades (HCAR0211)

- Single-edge razor blades (HCAR0212)
- Small T-pins (HCAR5100)
- Builder's triangle (HCAR0480)
- Small Phillips and flat blade screwdrivers
- Pliers with wire cutter (HCAR0630)
- Great Planes Plan protector (GPMR6167) or wax paper
- Sanding tools and sandpaper assortment
- Sealing Iron (TOPR2100)
- Double-sided foam tape (GPMQ4440)

## Optional Supplies and Tools

Here is a list of optional tools mentioned in the manual that will help you build the BLT.

- Great Planes CG Machine™ (GPMR2400)
- Top Flite Precision Magnetic Prop Balancer™ (TOPQ5700)
- Top Flite Hot Sock™ iron cover (TOPR2175)
- Straightedge with scale (HCAR0475)
- Cutting mat (HCAR0456)
- Masking Tape (TOPR8018)
- CA Debonder (GPMR6039)
- CA Applicator tips (GPMR6033)
- Great Planes 5-1/2" [140mm] Bar Sander (GPMR6169) and 150-grit adhesive back sandpaper (GPMR6183)
- Top Flite 320-grit sandpaper (TOPR8030) and 400-grit sandpaper (TOPR8032)

## IMPORTANT BUILDING NOTES

For the best performance, the BLT must be built light. One of the best ways to insure light weight is to build neatly and make good-fitting glue joints that require less glue. Here are some tips to help you build neatly and light.



1. The easiest way to cut balsa sticks is with a single-edge razor blade. To do so, position the stick over the plan, then place the razor blade on the stick where you wish to cut it. Press down lightly on the razor blade to make a mark where the stick is to be cut.

2. Take the stick off the plan and cut it over a cutting mat or a scrap piece of wood (*Okay, if you're careful you could go ahead and cut the stick right over the plan, but if you do, you may cut through the plan protector allowing the CA to soak through and glue the structure to the plan*).

3. Because of the small balsa sticks used in the tail, only where **necessary**, we recommend using small T-pins (HCAR5100) or small straight pins found in craft stores. Do not stick pins into the sticks near the ends, or the wood may split.

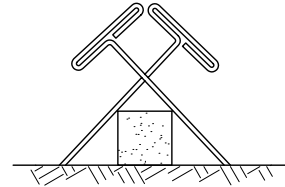

4. If you have difficulty with the T-pins splitting the small sticks, an alternate method is to use the "crossed-pin" technique. Insert the T-pins into the building board in a criss-cross fashion to hold the sticks to the plan.

5. Only a small amount of CA should be used to glue the parts together. Use the included CA applicator tips to control and pinpoint the amount of CA that comes from the bottle. When the tip becomes clogged, cut a short length of the tip off and continue. In addition to unnecessary weight, excess CA is difficult to sand. If you require additional CA tips, order no. GPMR6033 (5).

6. When applying CA, be careful to not glue your fingers to the structure. In the process of *unsticking* your fingers you can inadvertently damage the structure, thus requiring repairs and adding additional weight (*not to mention the aggravation!*).

7. Sanding requires a light touch to avoid damage. We found the best method for sanding is to use light strokes in the direction of the longest sticks. Be certain the sandpaper is **thoroughly** bonded to the bar sander. Lifted edges will catch the structure, causing damage. Use medium-grit sandpaper such as 150 or 220.

8. One of the best ways to insure a lightweight model is to proceed slowly and **build neatly**. Good glue joints with minimal adhesive are stronger, lighter and have a better appearance than poor-fitting joints with too much CA. Of course, you should take this approach with **all** of your projects!

9. Work over a flat surface. Cover the plans with Great Planes Plan Protector (GPMR6167) or wax paper so the parts will not adhere to the plan.

**PATTERNS**

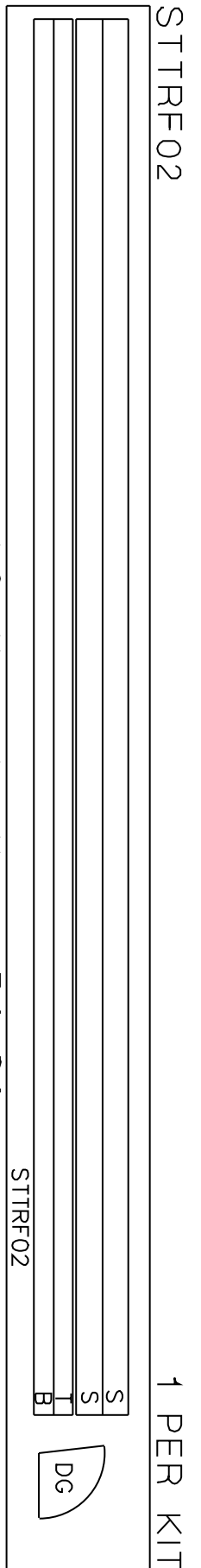

1/16" X 2-3/4" X 30" BALS

PARKW01

2 PER KIT

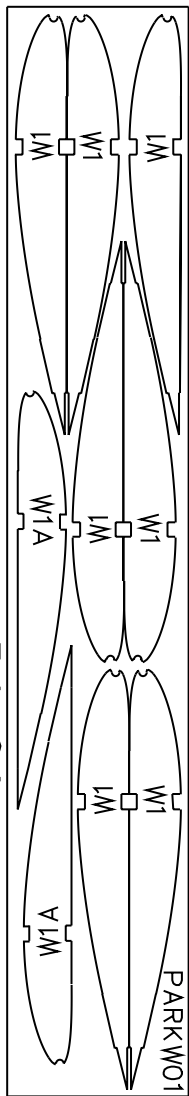

1/16" X 3" X 18" BALS

STRRW02

1 PER KIT

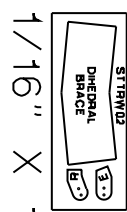

1/16" X 1-1/4" X 3-1/4" PLY

STRF01

PYLON FRONT PYLON REAR

1 PER KIT FUSE FORMERS

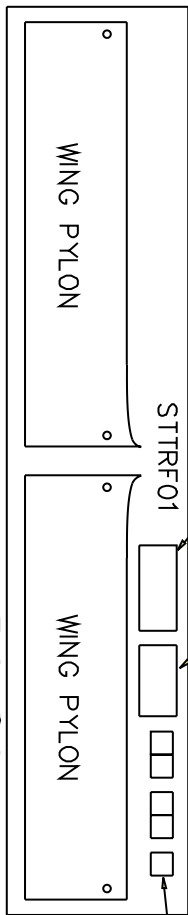

3/32" X 3" X 15" BALS

**METRIC CONVERSION**

1" = 25.4mm (conversion factor)

1/64" = .4mm	1" = 25.4mm
1/32" = .8mm	2" = 50.8mm
1/16" = 1.6mm	3" = 76.2mm
3/32" = 2.4mm	6" = 152.4mm
1/8" = 3.2mm	12" = 304.8mm
5/32" = 4mm	15" = 381mm
3/16" = 4.8mm	18" = 457.2mm
1/4" = 6.4mm	21" = 533.4mm
3/8" = 9.5mm	24" = 609.6mm
1/2" = 12.7mm	30" = 762mm
5/8" = 15.9mm	36" = 914.4mm
3/4" = 19mm	

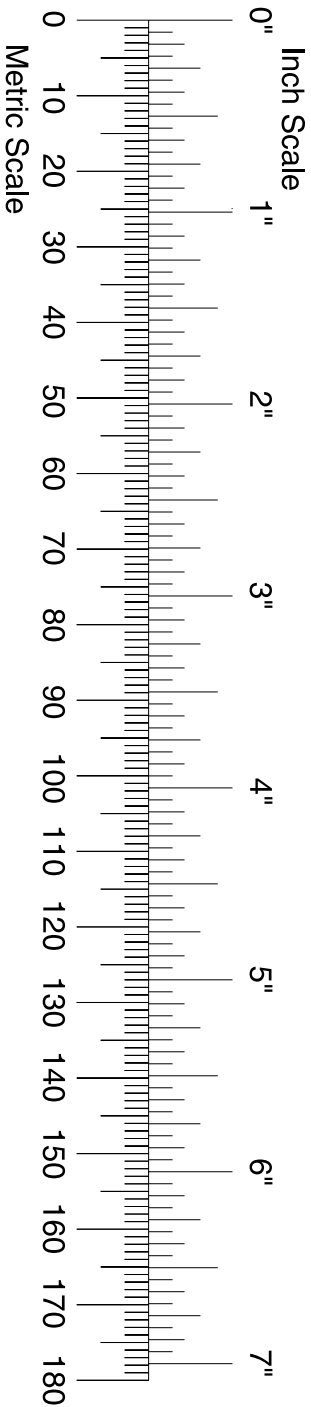

## BUILD THE TAIL SURFACES

### Build the Fin & Rudder

- 1. Cover the fin/rudder portion of the plan with wax paper or Great Planes Plan Protector.

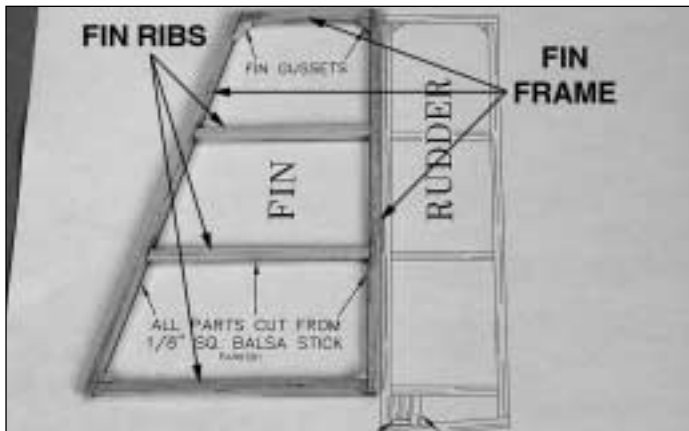

- 2. From the 1/8" x 1/8" x 24" (3.2mm x 3.2mm x 609.6mm) balsa sticks, cut and glue the **fin frame**, **fin ribs** and **fin gussets** together over the plan.

- 3. Remove the fin from your building board. Using a sanding bar with 220-grit sandpaper, very **lightly** sand the fin all over. Be sure to sand in the direction of the longest sticks.

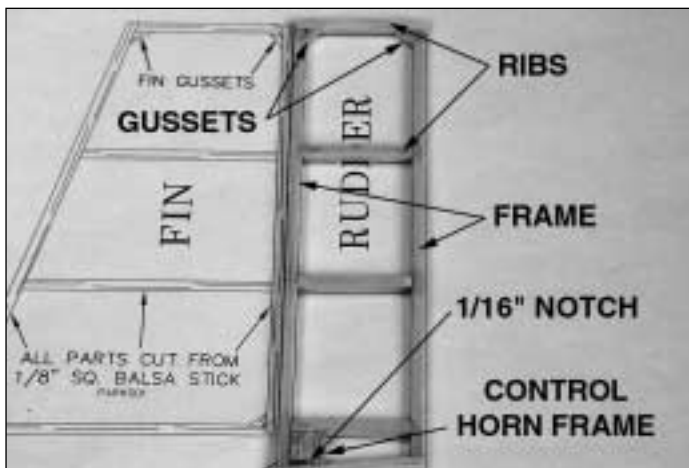

- 4. From the 1/8" x 1/8" x 24" (3.2mm x 3.2mm x 609.6mm) balsa sticks, cut and glue together the **rudder frame**, **ribs**, **control horn frame** and **corner gussets**. Use a hobby knife to cut the 1/16" (1.6mm) notch for the rudder control horn.

- 5. Remove the rudder from your building board. Using a sanding bar with 220-grit sandpaper, very **lightly** sand the fin all over. Be sure to sand in the direction of the longest sticks.

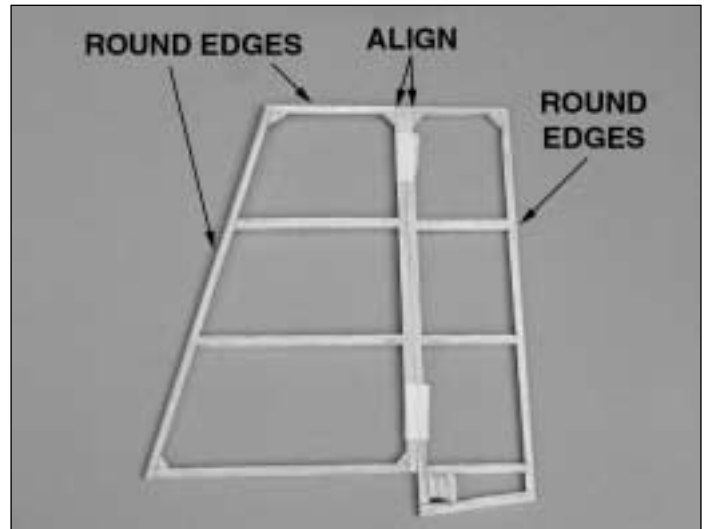

- 6. Tape the leading edge of the rudder to the trailing edge of the fin so that the fin and rudder align at the top. Use a sanding bar with 220-grit sandpaper to round the leading edge of the fin, the top of the fin and rudder and the trailing edge of the rudder.

### RIGHT SIDE OF RUDDER



- 7. Remove the rudder from the fin and sand the LE of the rudder at an angle as shown.



### HOW TO HOLD DELICATE PIECES FOR SANDING



An easy method to hold the delicate tail pieces while sanding the edges is to place the edge of the tail piece over the end of your building table. Position a second sanding bar on top of the tail piece, approximately 1" (25.4mm) back from the edge. The tail piece can now be held evenly and securely by applying slight pressure on the sanding bar.

## Build the Stabilizer & Elevator

- 1. Cover the stabilizer/elevator portion of the plan with wax paper or Plan Protector.

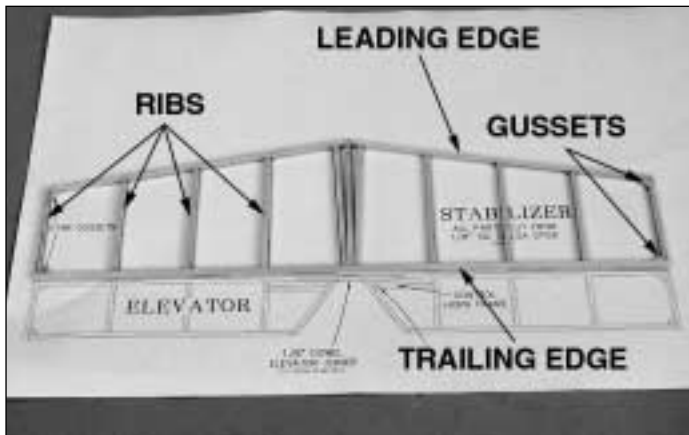

- 2. From the 1/8" x 1/8" x 24" (3.2mm x 3.2mm x 609.6mm) balsa sticks, cut and glue together the **stabilizer trailing edge, leading edge, ribs and corner gussets**.

- 3. Remove the stab from your building board. Using a sanding bar with 220-grit sandpaper, very lightly sand the stabilizer all over. Be sure to sand in the direction of the longest sticks.

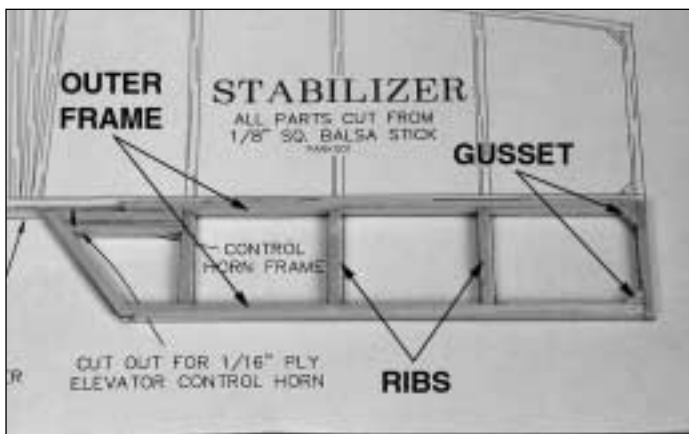

- □ 4. From the 1/8" x 1/8" x 24" (3.2mm x 3.2mm x 609.6mm) balsa sticks, cut and glue together the **outer frame, ribs and corner gussets** of one of the **elevators**.

- 5. Repeat step 4 to build the second elevator half.

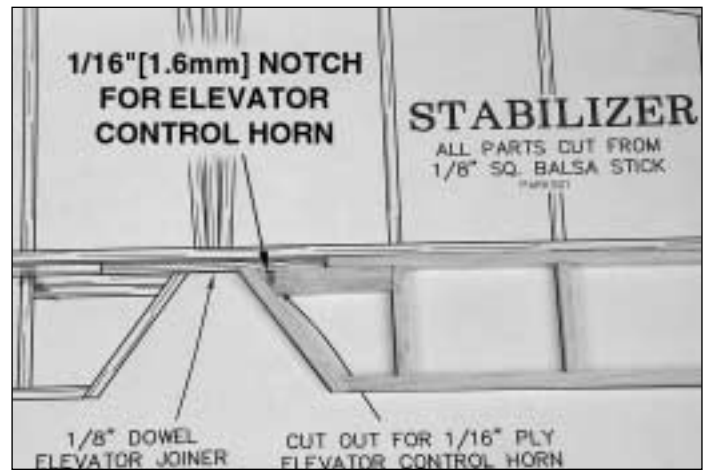

- 6. In the right elevator half, use a hobby knife to cut the 1/16" (1.6mm) notch for the elevator control horn.

- 7. Tape the two elevator halves to the trailing edge of the stabilizer, aligning the ends of the elevators with the ends of the stabilizer.

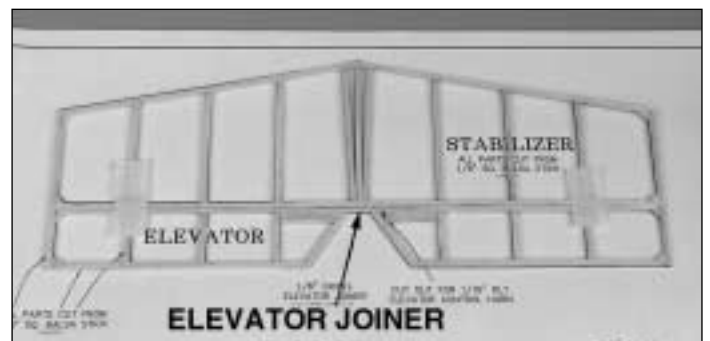

- 8. From the 1/8" x 24" (3.2mm x 609.6mm) hardwood dowel, cut an **elevator joiner** to fit between the two elevator halves.

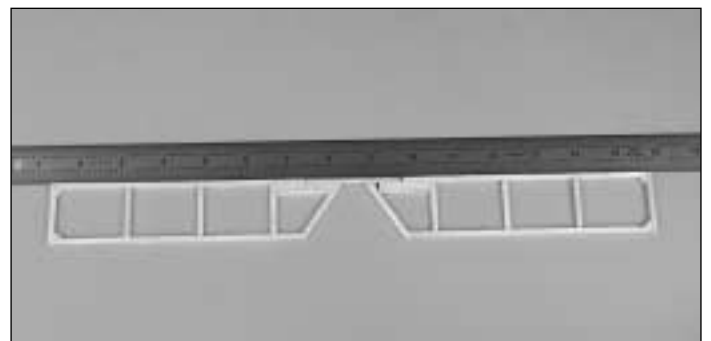

- 9. Remove the elevators from the stabilizer and position the elevator halves and the 1/8" (3.2mm) dowel against a straightedge. With the leading edge of the elevator halves and the dowel straight and flat against your building table, glue the dowel to the elevator halves.



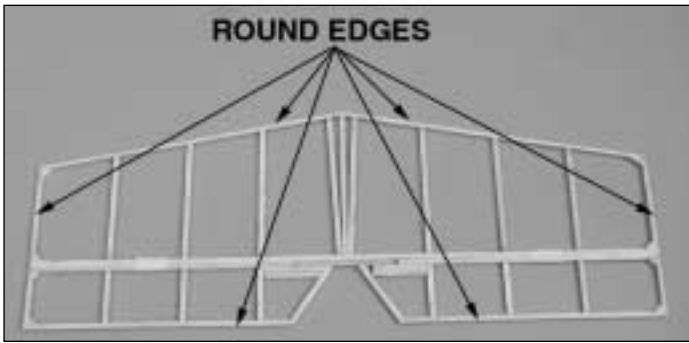

□ □ 10. Tape the leading edge of the elevator to the trailing edge of the stabilizer, aligning the ends. Use a sanding bar with 220-grit sandpaper to round the leading edge of the stabilizer, the ends of the stabilizer and elevator and the trailing edge of the elevator.



□ □ 11. Remove the elevator from the stab and sand the LE of the elevator at an angle as shown.

## BUILD THE WING

### Build the Wing Panels

Start by building the left wing panel right side up over the left wing panel plan so your progress matches the photos.

□ □ 1. Cover the left wing panel plan with Great Planes Plan Protector.

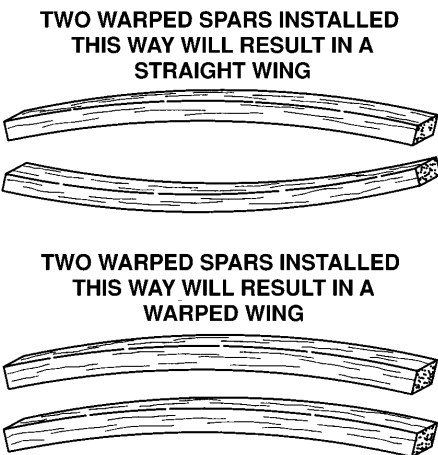

□ □ 2. Match the 1/8" x 1/4" x 24" (3.2mm x 6.4mm x 609.6mm) balsa main spars so any warps will counteract each other.

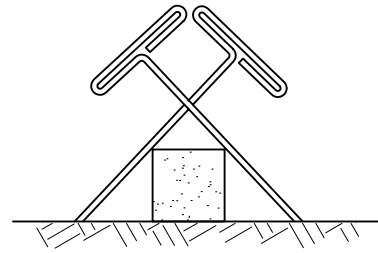

□ □ 3. Pin one of the main spars in position over the plan, aligning one end of the main spar with the outside edge of the root rib W1A.



□ □ 4. Pin one of the 1/32" x 3/4" x 24" (.8mm x 19mm x 609.6mm) balsa trailing edge sheets in position over the plan, aligning one end of the trailing edge sheet with the outside edge of the root rib W1A.



□ □ 5. Starting at the wing tip, glue the seven laser-cut 1/16" (1.6mm) balsa W1 and one W1A rib over the main spar and trailing edge sheet, perpendicular to the building board. **Important: Do not install the W1A root rib until the next step.**

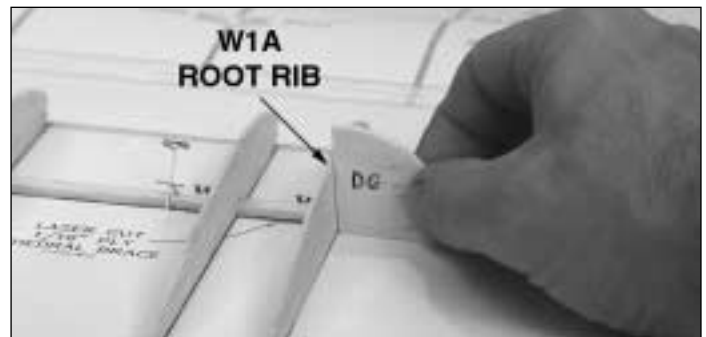

□ □ 6. Position the W1A root rib in place over the main spar. Use the laser-cut 1/16" (1.6mm) balsa dihedral gauge to set the rib at the proper angle before gluing it to the main spar and the trailing edge sheet.

□ □ 7. Position the top 1/8" x 1/4" x 24" (3.2mm x 6.4mm x 609.6mm) balsa main spar in the rib notches with one end flush with the outside edge of the root rib and glue to all the ribs.

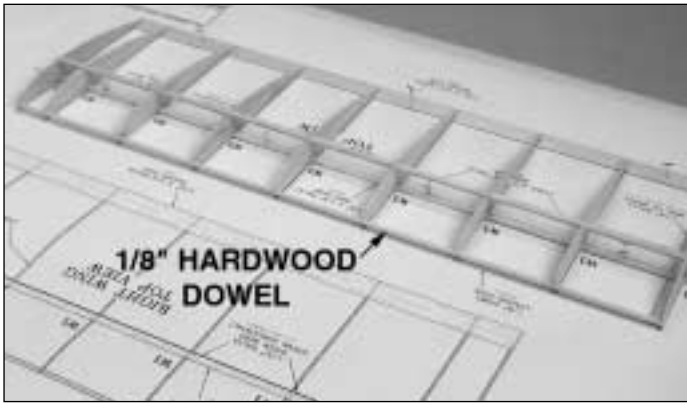

□ □ 8. Cut one of the 1/8" x 24" (3.2mm x 609.6mm) hardwood dowels so that it fits in the notches at the front of the wing ribs, from the root to the tip rib. Glue the dowel to the ribs. Save the excess dowel for use as a wing hold down dowel.

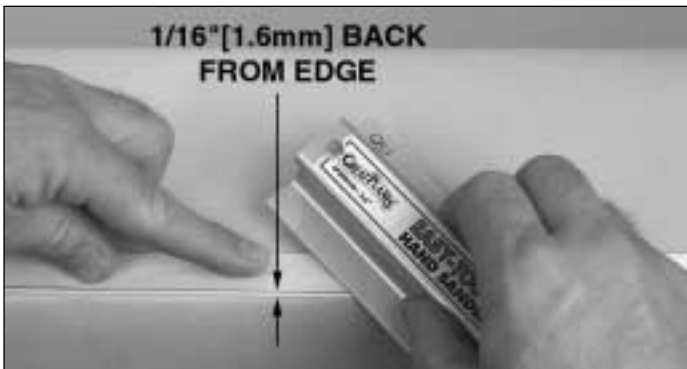

□ □ 9. To make a **top trailing edge sheet**, draw a line 1/16" (1.6mm) from the edge of a second 1/32" x 3/4" x 24" (.8mm x 19mm x 609.6mm) balsa sheet. Sand a taper along the edge up to the line. The sheet should fit in the notches at the trailing edge of the wing ribs and blend into the bottom trailing edge sheet.

**Hint:** To avoid breaking the trailing edge sheet when sanding the taper, sand across the grain, not lengthwise.

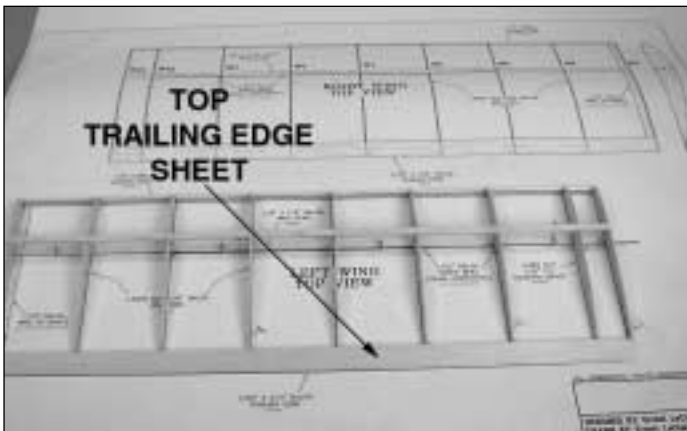

□ □ 10. Glue the top trailing edge sheet to the top of the wing ribs and the aft edge of the bottom trailing edge sheet.

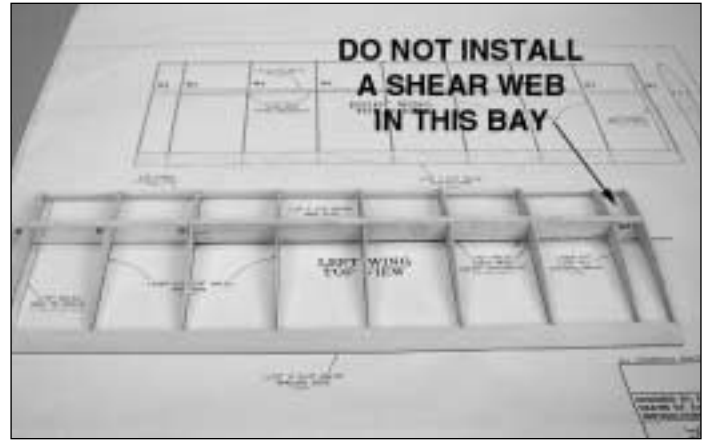

□ □ 11. From a 1/32" x 3/4" x 24" (.8mm x 19mm x 609.6mm) balsa sheet, cut and glue **shear webs**, horizontally, to the top and bottom spars in the locations shown on the plan. Make sure they are glued securely to the wing spars and ribs. **Do not install shear webs in the rib bay between the W1A ribs.**

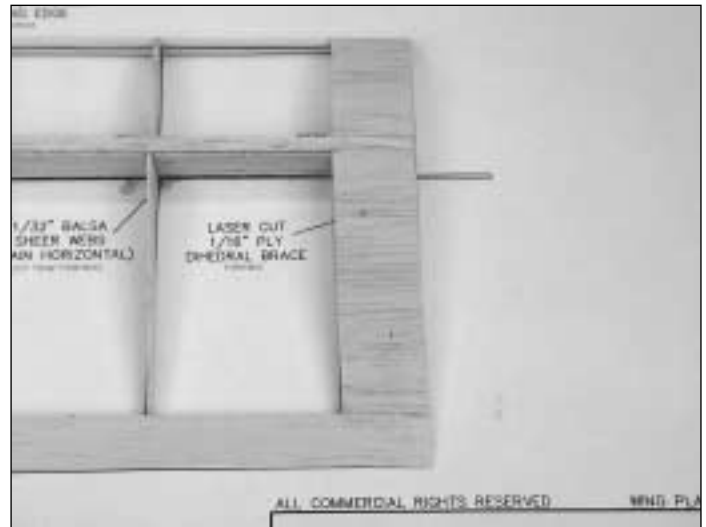

□ □ 12. From a 1/32" x 3" x 15" (.8mm x 76.2mm x 381mm) balsa sheet, cut pieces to make the **top center sheeting** to fit between the wing spar and trailing edge sheet and between the wing spar and the leading edge dowel. When satisfied with the fit, apply medium CA to the top of the W1A ribs and press the sheet in place. Hold the sheet in position until the CA cures.

□ □ 13. Carefully sand the top center sheeting flush with the wing spar, leading edge dowel and trailing edge sheet.

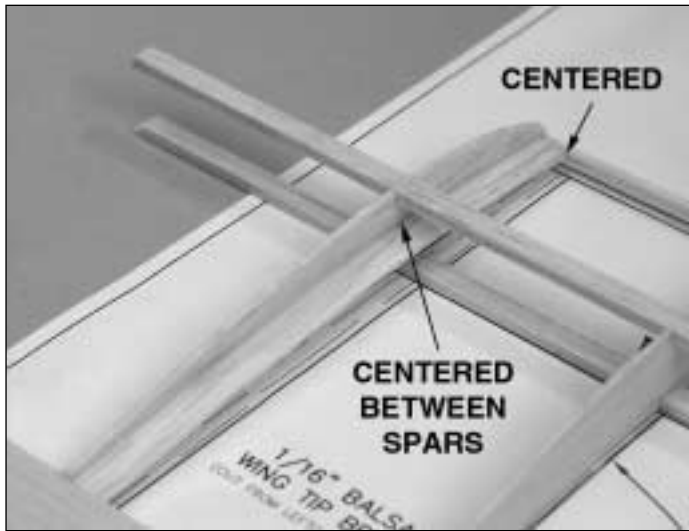

□ □ 14. From the remaining 1/16" balsa STTRF02 laser-cut sheet, cut two **wing tip braces** 5/16" x 6-1/8" (7.9mm x 155.5mm). Glue the wing tip brace on the inside of the W-1 wing tip rib. The wing tip brace should be centered on the aft edge of the leading edge dowel, between the wing spars and the trailing edge sheeting.



□ □ 15. Remove the wing from your building board and carefully sand off any excess glue. From the remaining 1/32" x 3" x 15" (.8mm x 76.2mm x 381mm) balsa sheet, cut pieces to make bottom center sheeting to fit between the leading edge dowel and wing spar and from the wing spar to the trailing edge sheet. Glue the sheets in place and sand carefully.

□ □ 16. Cut and sand the wing spars and trailing edge sheeting flush with the wing tip rib.

□ 17. Now go back to step 2 and build the right wing panel. **Remember!** Build it over the right wing plan.

## Join the Wing Panels

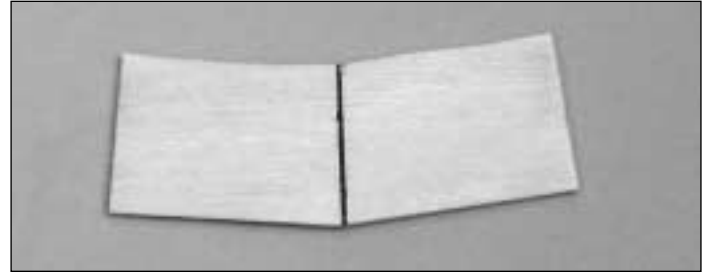

□ 1. Draw a vertical centerline on the laser-cut 1/16" ply dihedral brace.

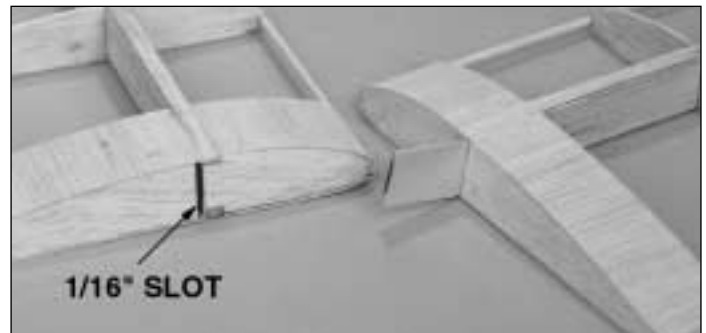

□ 2. Using a hobby knife, carefully cut a 1/16" slot in rib W1A, just behind the main spar on both wing panels. Trial fit the dihedral brace in the slots.

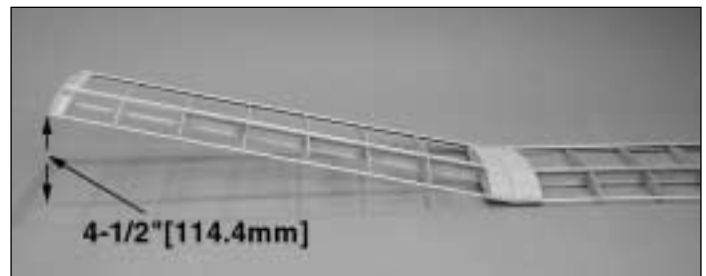

□ 3. Trial fit the wing halves together. With one wing half flat on your building board, block-up the wing tip of the other wing half so that it is 4-1/2" (114.3mm) off of your building board. Use a sanding bar to sand the center joint as necessary until the wing halves fit together without any gap.

□ 4. When satisfied with the fit, apply **medium CA** to both sides of half of the dihedral brace. Insert the dihedral brace into one of the wing halves so that the brace is attached to the two main spars. After the CA has cured, apply medium CA to both sides of the other half of the dihedral brace and the root rib. With one wing half flat on your building board and the wing tip of the other wing half blocked up as before, quickly slide the two wing halves together. Before the CA cures, make sure the trailing edges are aligned.

**NOTE:** You may prefer to use 6-minute epoxy instead of CA. This will allow more working time.

## BUILD THE FUSELAGE

### Assemble the Fuselage Sides

□ 1. With Great Planes Plan Protector positioned over the fuselage top view, pin the laser-cut 1/16" (1.6mm) **fuselage bottom** (the side with the "B" facing up) in position over the plan.

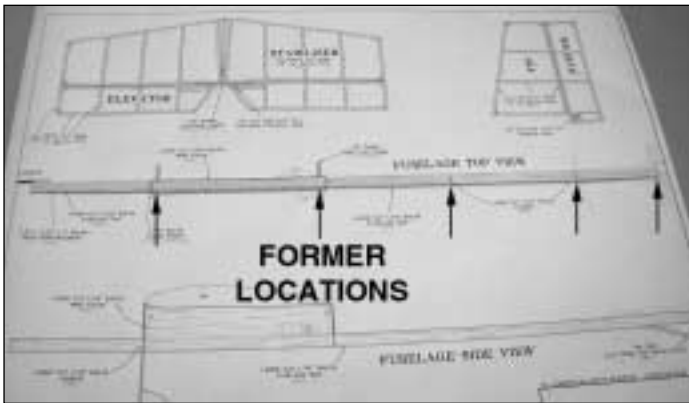

□ 2. On the fuselage bottom, mark the location for the five fuselage formers.

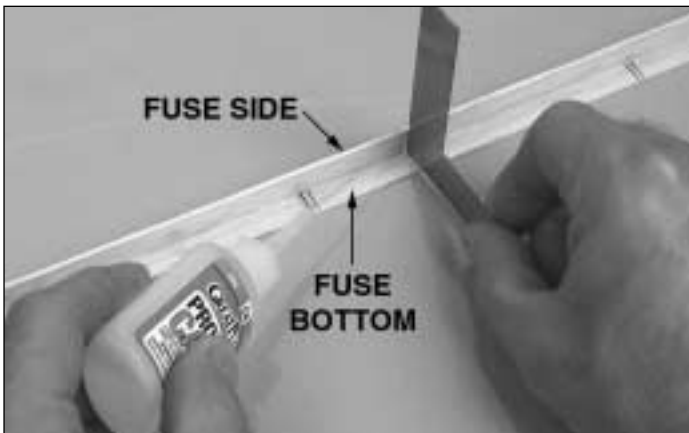

□ 3. Position the laser-cut 1/16" (1.6mm) balsa **fuselage side** so that the edge is flat against the building board and one end of the fuselage side is aligned with one end of the fuselage bottom. Make sure the "S" is facing inward. Then, glue the side, perpendicular, to the bottom.

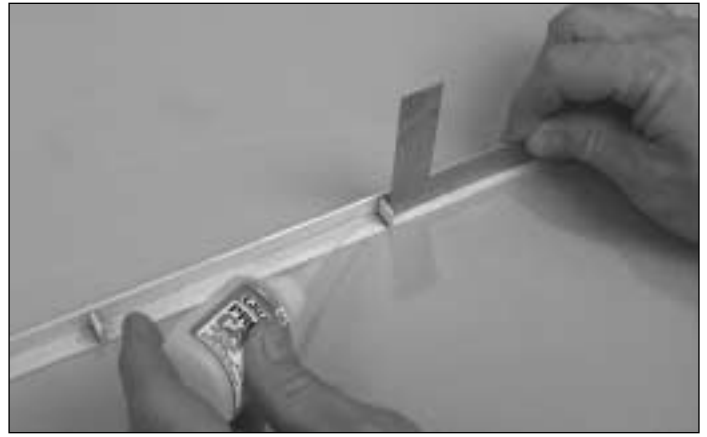

□ 4. At the marks on the fuselage bottom, glue the five laser-cut 3/32" (2.4mm) **fuselage formers**, perpendicular to the fuselage bottom and side.



□ 5. Make sure that the "S" is facing inward and the edge of the fuselage side is flat against the building board. Glue the second fuselage side to the fuselage bottom and the five formers. **Note:** You may need to sand the formers flush with the side and bottom.

□ 6. Remove the pins holding the fuselage bottom to the building board. Re-pin the fuselage to the building board by inserting pins through the fuselage sides. This will allow the fuselage top to be attached without trapping the pins inside the fuselage.

□ 7. Test fit the laser-cut 1/16" (1.6mm) balsa **fuselage top** between the fuselage sides. The top should be flush with the top edge of the fuselage sides. When satisfied with the fit, apply medium CA to the top of the formers. Position the fuselage top on the formers so that the end of the fuselage top is aligned with the ends of the fuselage sides. Apply thin CA along the joint between the fuselage top and sides.

□ 8. Lightly sand the sides of the fuselage to remove any excess glue.



□ 9. Insert and glue the 3/8" x 3/8" x 1" (9.5mm x 9.5mm x 25.4mm) balsa **nose reinforcement** in the front of the fuselage so that it is flush with the sides, top and bottom.

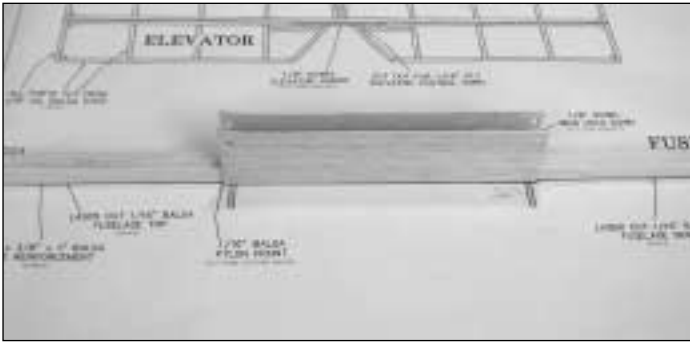

□ 10. With the fuselage pinned over the plan top view, glue both laser-cut 3/32" (2.4mm) balsa **wing pylons** to the fuselage sides, perpendicular to your building board.

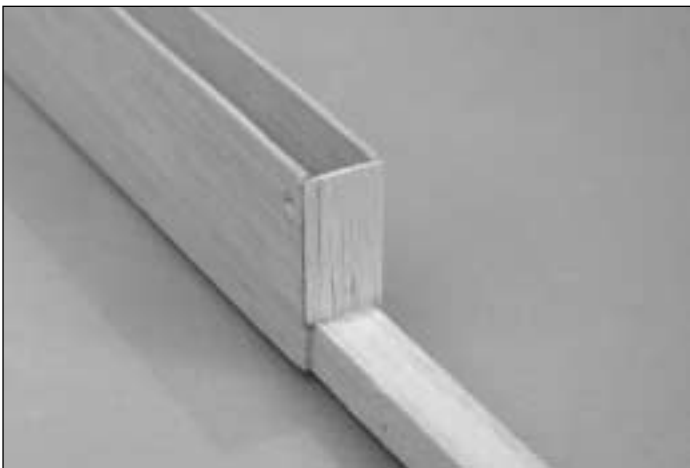

□ 11. Glue the laser-cut 3/32" (2.4mm) balsa **pylon aft plate** to the top of the fuselage and the aft end of the wing pylon. The aft plate should be flush with the sides of the wing pylon.



□ 12. Position the 1/16" (1.6mm) **wire landing gear** on the fuselage top, against the front of the wing pylon to act as a spacer. Glue the laser-cut 3/32" (2.4mm) balsa **pylon forward plate** to the forward end of the wing pylon. The forward plate should be flush with the sides of the wing pylon. After the glue cures, remove the landing gear.

□ 13. Sand the wing pylon sides to remove any excess glue from the joint between the pylon sides and ends.

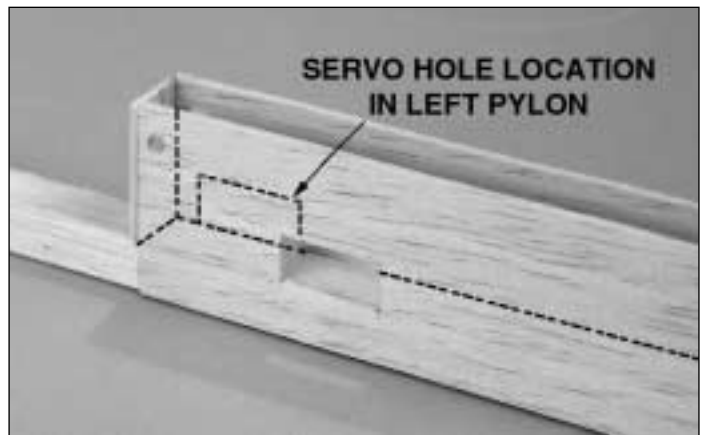

□ 14. Cut one hole in the side of each wing pylon for the elevator and rudder servos. The holes should be just large enough to fit the servo you will be using. The side of each servo should set on the top of the fuselage. **Note:** Make sure to off-set the servo holes from each other, as shown on the plan.



□ 15. From a 1/8" x 1/8" x 24" (3.2mm x 3.2mm x 609.6mm) balsa stick, assemble a tail skid and glue it to the bottom aft end of the fuselage.

## FINISHING

### Final Sanding

Fill any scuffs and dings with balsa filler or by "expansion." See Expert Tip below. After the filler has dried, use fine sandpaper to even and smooth all the edges, seams and surfaces. Remove all the balsa dust from the model with compressed air or a tack cloth.



#### REMOVING SURFACE BLEMISHES

Many surface blemishes on a framed model are caused by bumps and balsa chips on the work surface. This type of "ding" is best repaired by applying a drop or two of tap water to the blemish, then running a hot sealing iron over the spot to expand the wood fibers. After the surface has dried, sand the expanded area smooth.

### Covering the Model

The technique we will describe here is how the model pictured on the box was finished. Cover the model with Top Flite® Transparent MonoKote® film, using the sequence that follows. The use of a Top Flite MonoKote Hot Sock™ on your covering iron will prevent scratching the MonoKote film. **NOTE:** Transparent MonoKote film is lighter than regular MonoKote film.

If you are covering your Basic Light Trainer with Coverite Micafilm, Coverite Balsarite Fabric Balsa Conditioner (COVR2500) will need to be applied to the surface of the plane. Micafilm does not have a heat activated glue on the back of the covering. Balsarite is heat activated and will bond the covering to the surface of the plane.

#### Suggested Covering Sequence

**Important:** Do not shrink the covering until both sides of the part are covered. This will reduce the chances of twisting the part.

1. The bottom, then the top of the stabilizer
2. Cover only the top of the elevator
3. Both sides of the fin
4. Cover both sides of the rudder
5. Both wing tips
6. Bottom of the wing
7. Top of the wing

**Note:** The fuselage is not covered.

### Add Washout (wing twist)

An important characteristic of most airplanes is their ability to stall gently. One way to achieve this is with washout built into the wing. Washout is when the wing is twisted at the tips so that the TE of the wing is higher than the LE. This will cause the wing to first stall next to the fuselage, not at the tip. Because the Basic Light Trainer is designed to be very light, washout would be difficult to build into the wing. The following procedure will explain how to put washout into the wing by shrinking the covering. You will find that some coverings will stay tighter than others. Fabrics seem to relax slightly over time and may require reshinking more than once.

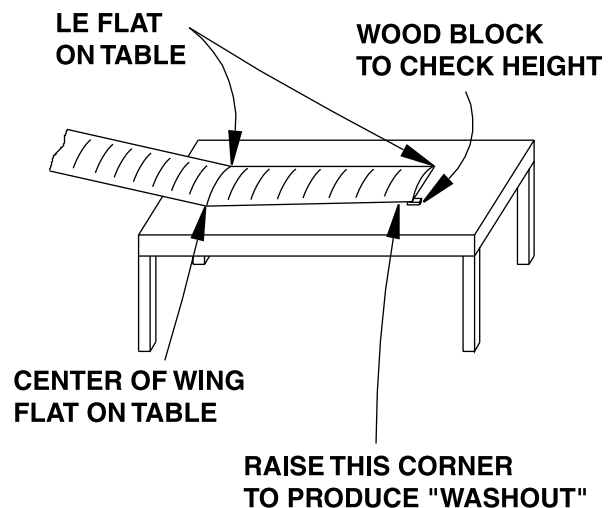

To put washout in the Basic Light Trainer wing, have someone hold the center of the wing firmly down against the flat building surface. Now grasp the tip of the wing and gently twist it so that the trailing edge raises off the surface. While holding in this twist, use a heat gun to "reshrink" the covering. Heat both the top and the bottom. When you let go of the tip, you will see that the wing will retain some of the twist.

You must continue twisting and re-shrinking until the TE is 1/8" (3.2mm) off the surface **at both tips**. As an aid in getting this height correct, you may make a small wood block 1/8" (3.2mm) high by gluing together pieces of leftover wood. Keep this block handy while twisting and heating, to check your progress.

Depending on what type of covering you have used, you may find that, in time, some of the washout may disappear. Check it after an hour and repeat the above process if necessary. Also, recheck it periodically before you go flying.

## COMPLETING ASSEMBLY

### Mount the Stabilizer & Fin



□ 1. From the remaining 1/8" (3.2mm) hardwood dowel cut two **wing hold downs** 2" (50.8mm) long. Use a sanding bar to round the ends of the wing hold downs.

□ 2. Center the wing hold downs in the wing pylon and use CA to secure them.



□ 3. Mount the wing, centered on the wing pylon, using **#32 rubberbands**. Center the stabilizer at the aft end of the fuselage so that the TE of the stabilizer is 1/8" forward of the aft end of the fuse and the LE joint is centered on the top of the fuse. From a few feet behind the fuselage, view the stabilizer, checking that the stabilizer is parallel with the wing. If not, remove the stabilizer and check that the fuselage is not twisted. If it is, dampen the fuse slightly and twist it in the opposite direction until the wood dries. Recheck the stabilizer/wing alignment. When satisfied with the fit, use thin CA to glue the stab to the fuse.

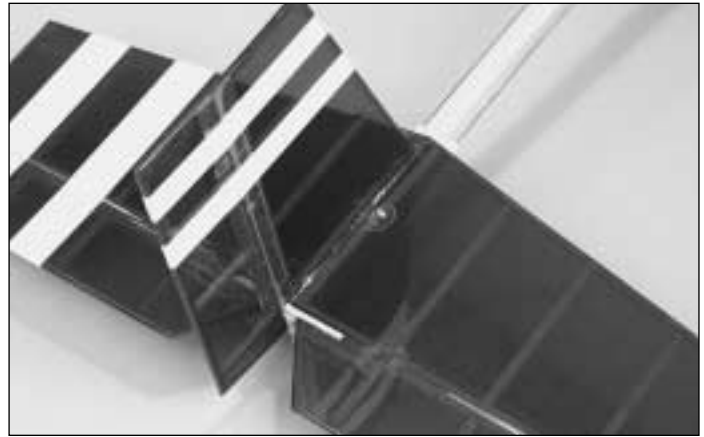

□ 4. With the TE of the fin flush with the aft end of the fuse, use CA to glue the fin along the center line of the stab, perpendicular to the top of the stab.

CELLOPHANE  
TAPE



□ 5. Position the rudder as shown. On the right side of the rudder, use clear cellophane tape along the joint between the rudder and the fin. Attach the elevator to the stab by applying cellophane tape along the top joint.



□ 6. Glue the die-cut 1/16" (1.6mm) plywood **rudder** and **elevator horns** in the slots in the rudder and elevator. **Note:** Use a pin to enlarge the holes for the pushrods, if needed.

## RADIO INSTALLATION

### Mount the Servos

1. Before starting the radio installation, put the motor battery on your charger. Then, when the battery is required for the radio installation, it will be charged.
2. Clean the bottom of the rudder and elevator servos with rubbing alcohol. Apply a piece of double-sided tape (not included) to the bottom of each servo.

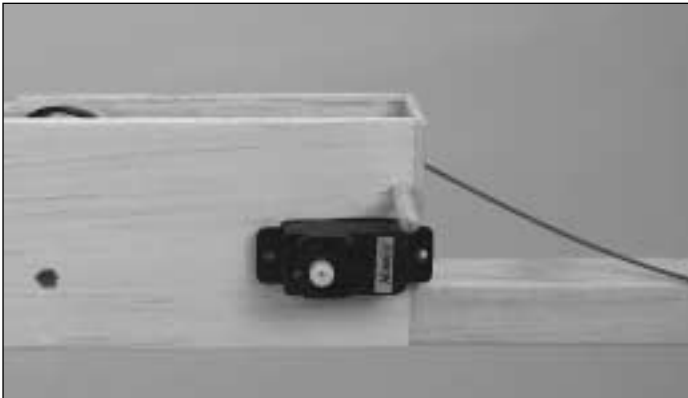

3. Remove the backing from the double-sided tape and insert the servos into the holes in the side of the wing pylon so that the double-sided tape is attached to the inside of the wing pylon.
4. Plug the two servos and the electronic speed control into the micro receiver following the receiver manufacturer's instructions. Place the electronic speed control and receiver inside the wing pylon.

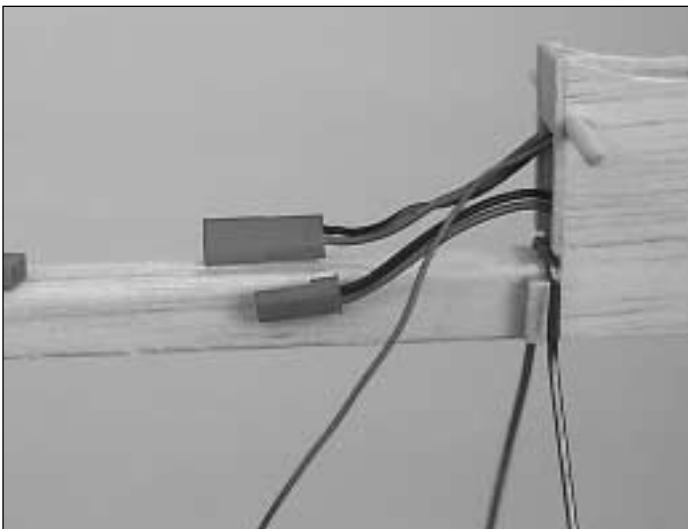

5. Cut a small hole in the front of the wing pylon and route the receiver antenna and plugs for the motor and motor battery out through the front. You can glue a couple of small pieces of the white tube to the bottom of the fuselage and route the receiver antenna through the tubes towards the tail.

## ASSEMBLE THE GEAR DRIVE

Follow these assembly instructions for the Great Planes ElectriFly™ T-280GD ESC motor system and gear drive (GPMG0430).



1. Use denatured alcohol or other solvent to clean the motor shaft. Roughen the shaft with 320-grit sandpaper so glue will adhere.



2. Apply a small drop of medium CA to the hole in the pinion gear, then press the gear onto the motor shaft using the base of a large screwdriver or something similar. While doing this, do not rest the base of the motor on your workbench, but support the motor shaft with a piece of hardwood. This way, the pressure applied to the gear will not displace the armature in the motor.

3. Press the motor by hand as far as it will go into the gear drive unit. If it is a loose fit, secure the motor to the gearbox with a small drop of CA.



## MOUNT THE MOTOR

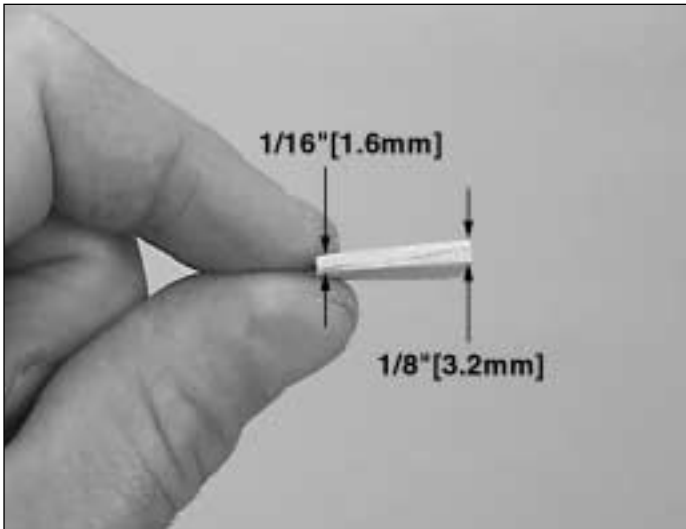

□ 1. From a leftover 1/16" (1.6mm) laser-cut balsa sheet, cut two pieces 1/16" x 1/2" x 3/4" (1.6mm x 12.7mm x 19mm). Glue the two pieces together to make a **motor wedge** 1/8" x 1/2" x 3/4" (3.2mm x 12.7mm x 19mm). Use a sanding bar to sand the top of the wedge so that the front of the wedge is 1/16" (1.6mm) thick and the back is 1/8" (3.2mm) thick.

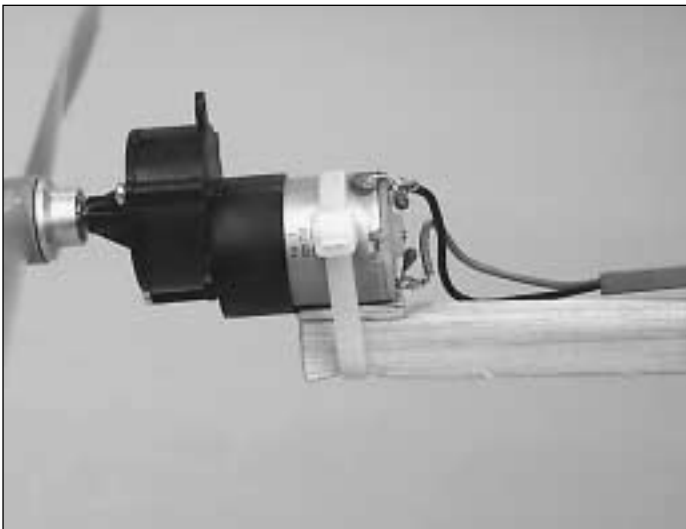

□ 2. Glue the motor wedge on the top front of the fuse so that the 1/16" (1.6mm) edge is flush with the front of the fuse. Place the motor on the wedge and secure it with a large **nylon tie strap**.

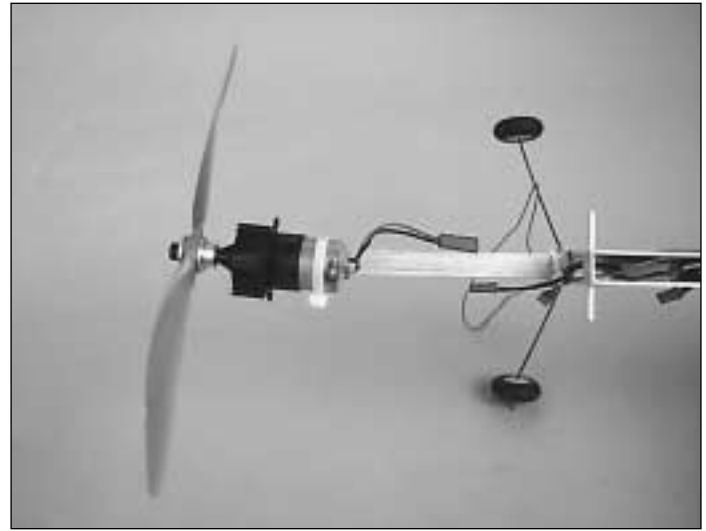

□ 3. The Basic Light Trainer will fly better if the motor is set with 1 to 2 degrees of right thrust. This can be accomplished by laying the fuselage on its side and using a protractor to angle the motor. After the right thrust is set, apply a couple of drops of CA along the joint between the motor and the motor wedge to secure the motor.

□ 4. Plug the motor into the electronic speed control. Secure the motor and electronic speed control wires to the fuselage with the small **nylon tie strap**.

## INSTALL THE PUSHRODS

□ 1. With the propeller removed from the motor, switch on your transmitter. Move the throttle stick to the off position or towards you. Then, plug in the charged motor battery. To switch on your electronic speed control, follow the speed control manufacturer's instructions.

□ 2. Center the elevator and rudder servos. Be sure the trim levers on your transmitter are centered. Switch off the electronic speed control followed by the transmitter and unplug the battery.

□ □ 3. Cut one of the .030 x 20-1/2" (.7mm x 520.7mm) wires 13-1/2" (342.9mm) long. The 13-1/2" (342.9mm) wire is referred to as the **forward pushrod** and the 4-1/2" (114.3mm) wire is the **aft pushrod**.

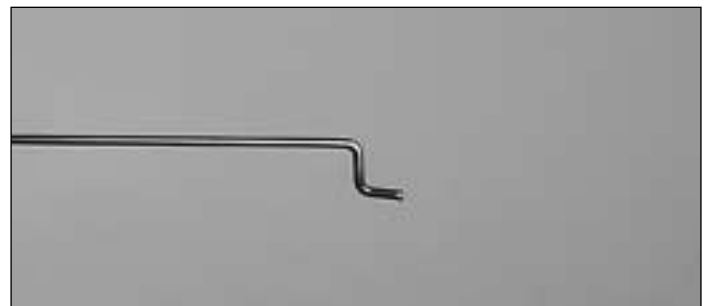

□ □ 4. Make a Z-bend in one end of the forward and aft pushrods.

□ □ 5. Cut three 1/4" (6.4mm) long **guide tubes** from the 6-1/2" long white plastic tube. Slide the guide tubes over the forward pushrod.

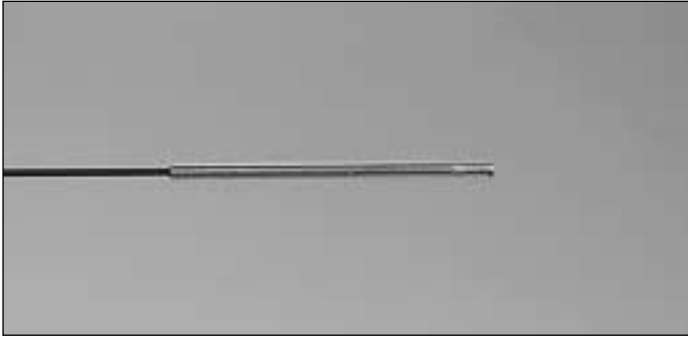

□ □ 6. 1/2" (12.7mm) from the end of the forward pushrod, make a slight bend. Slide the pushrod half-way into one of the 1/16" x 2" (1.6mm x 50.8mm) aluminum **pushrod adjusters**. The bend should cause the pushrod to fit tight in the pushrod adjuster.

□ □ 7. Insert the Z-bend of the forward pushrod in the rudder servo arm and the Z-bend of the aft pushrod in the inner hole of the rudder control horn.

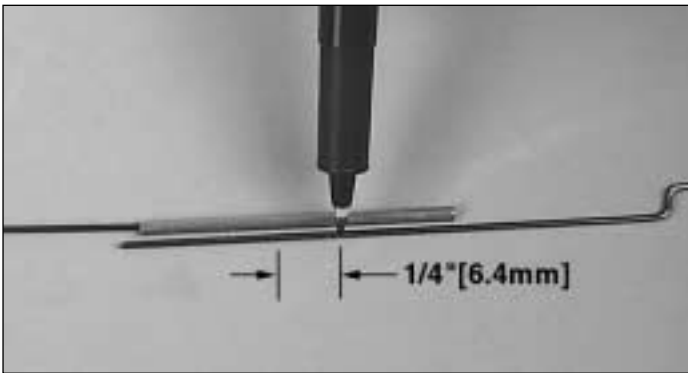

□ □ 8. With the rudder servo arm and rudder centered, lay the aft pushrod over the pushrod adjuster. Mark the aft pushrod approximately 1/4" (6.3mm) back from the center of the pushrod adjuster.

□ □ 9. Remove the aft pushrod from the control horn and cut it at the mark. Make a slight bend in the end of the pushrod so that it fits tightly in the pushrod adjuster.

□ □ 10. Remove the servo arm and forward pushrod from the rudder servo. Insert the aft pushrod in the pushrod adjuster.

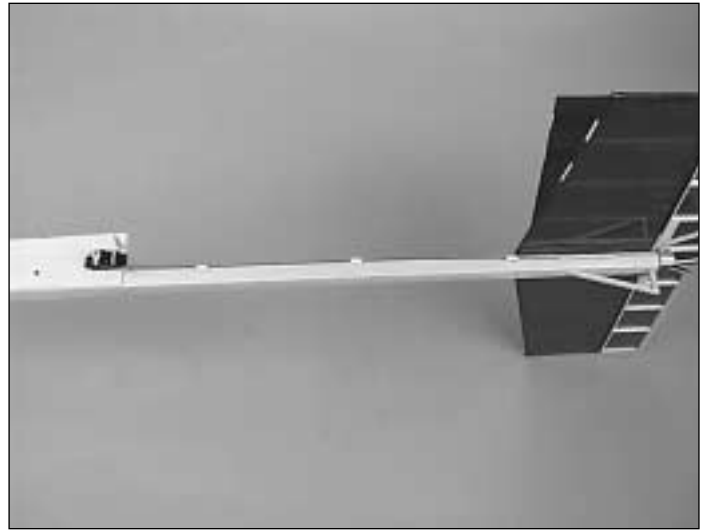

□ □ 11. Reinstall the aft pushrod in the rudder control horn. Insert the forward pushrod in the servo arm and install it on the rudder servo.

□ □ 12. With the rudder servo arm centered, slide the forward or aft pushrod in the pushrod adjuster so that the rudder is centered.

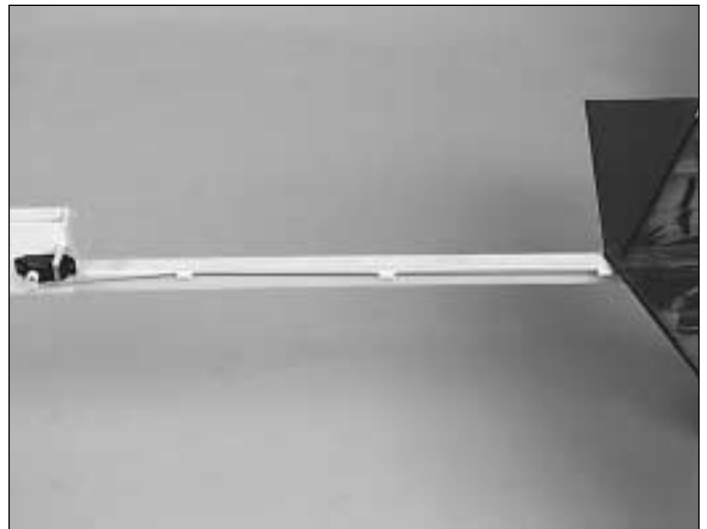

□ □ 13. Glue the three guide tubes to the side of the fuselage. One should be in front of the stabilizer, the second tube should be approximately 2" aft of the wing pylon and the third tube should be centered between the first two.

□ □ 14. Return to step 3 and install the elevator pushrod following the same procedure.

## INSTALL THE LANDING GEAR

- ❑ 1. Reinstall the wire landing gear over the fuselage, positioned under the pylon forward plate.

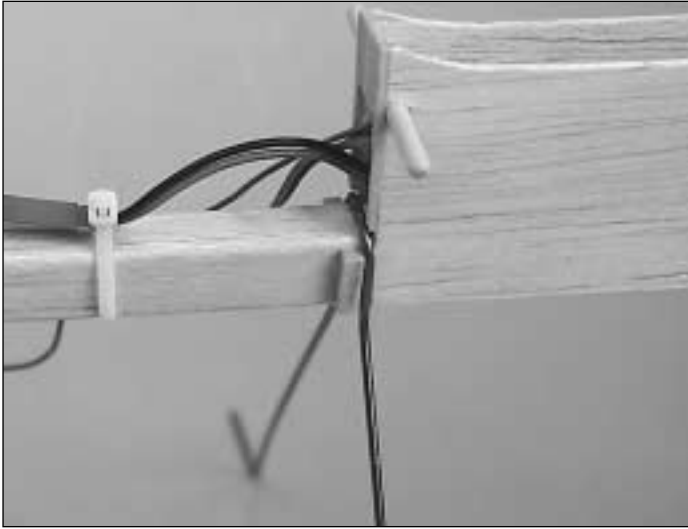

- ❑ 2. Glue a 1/8" x 1/8" x 3/8" (3.2mm x 3.2mm x 9.5mm) long balsa stick on each side of the fuselage, in front of the landing gear wire.

- ❑ 3. Slide the 1-1/2" wheels onto each side of the landing gear wire. Press a nylon wheel collar onto the wire landing gear to secure the wheels.

## SET THE CONTROL THROWS

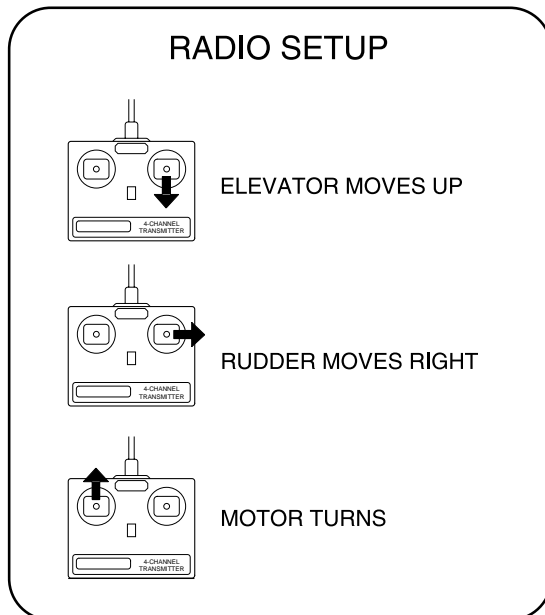

- ❑ 1. Adjust the position of the pushrods at the servo horns and the control horns to change the amount of throw. You may also use the ATV's if your transmitter has them.

We recommend the following control surface throws:

**Elevator:** 5/8" up 5/8" down

**Rudder:** 7/8" left 7/8" right

**IMPORTANT:** The balance and control throws for the Basic Light Trainer have been extensively tested. This chart indicates the settings at which the Basic Light Trainer flies best. Please set up your model to the specifications listed above. If, after you become comfortable with your Basic Light Trainer and you would like to adjust the throws to suit your tastes, that's fine. Too much throw can make the plane harder to handle or force it into a stall or snap roll, so remember, "more is not always better."

## BALANCE YOUR MODEL

**Note:** This section is **VERY** important and must **NOT** be omitted! A model that is not properly balanced will be unstable and possibly unflyable.

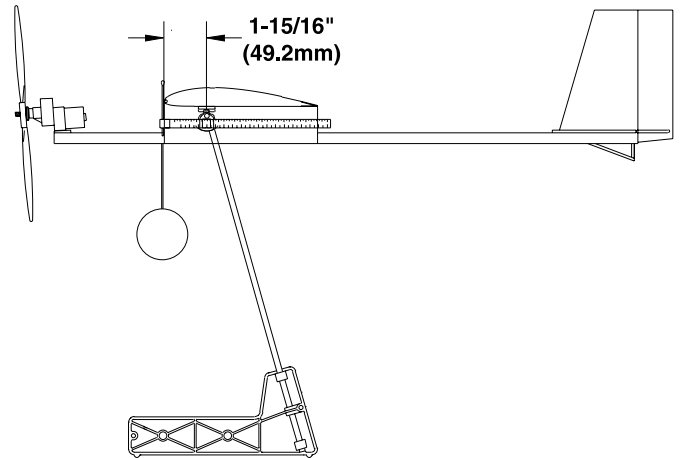

- ❑ 1. Accurately mark the balance point on the bottom of the wing on both sides of the fuselage. The **balance point (C.G.)** is shown on the fuse plan and is located **1-15/16" back from the leading edge** of the wing. This is the balance point at which your model should balance for your first flights. After the initial trim flights and when you become more acquainted with your Basic Light Trainer, you may wish to experiment by shifting the balance up to 1/4" **forward** or **backward** to change its flying characteristics. Moving the balance **forward** may improve the smoothness and stability, but the model may then require more speed for takeoff and may become more difficult to slow down for landing. Moving the balance **aft** makes the model more agile with a lighter, snappier "feel." In any case, **please start at the location we recommend. Do not at any time balance your model outside the recommended range.**

□ 2. With all parts of the model installed (except for the motor battery), lift the model at the balance point. If the tail drops, the model is “tail heavy”. If the nose drops, it is “nose heavy”. Use a piece of cellophane tape to attach the motor battery to the bottom of the fuse while balancing the plane. The tape will allow you to move the battery forward or aft. Because excess weight is critical to the flight performance of park flyers, it is best to balance the plane by moving the battery.

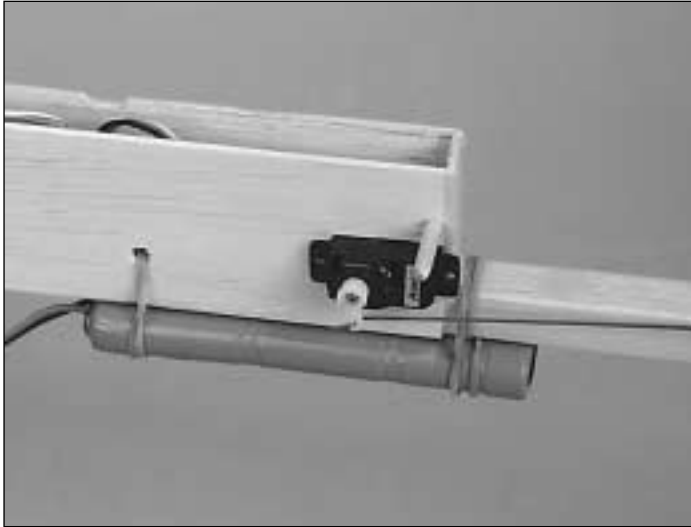

□ 3. After the plane is properly balanced, mark the location for the motor battery. The motor battery is held on to the fuse with two small rubber bands. Our plane balanced with the motor battery mounted under the two servos. We attached the aft end of the battery to the fuse with a small rubber band. Make a small hole through the wing pylon and route a second small rubber band through the hole and attach it to the front of the motor battery.

## ***PREFLIGHT***

### ***Charge the Transmitter Batteries***

Follow the instructions that came with your radio to charge the batteries the evening before you plan to fly. You should always charge the transmitter batteries before flying and at other times as recommended by the radio manufacturer.

### ***Identify Your Model***

No matter if you fly at an AMA sanctioned R/C club site or if you fly somewhere on your own, you should always have your name, address, telephone number and AMA number on or inside your model. It is **required** at all AMA R/C club flying sites and AMA sanctioned flying events. Fill out the identification tag on page 23 and place it on or inside your model.

## ***Ground Inspection***

Before you fly you should perform one last overall inspection to make sure the model is truly ready to fly and that you haven't overlooked anything. If you are not thoroughly familiar with the operation of R/C models, ask an experienced modeler to perform the inspection. Check to see that you have the radio installed correctly and that all the controls are connected properly. The motor must also be checked by confirming that it reaches full power and the prop is rotating in the correct direction. Make certain all control surfaces (elevators and rudder) are secure, the pushrods are connected, the controls respond in the correct direction, radio components are securely mounted, and the C.G. is correct.

## ***Range Check***

Ground check the operational range of your radio before the first flight of the day. With the transmitter antenna collapsed and the receiver and transmitter on, you should be able to walk at least 100 feet away from the model and still have control. Have an assistant stand by your model and, while you work the controls, tell you what the control surfaces are doing. Repeat this test **with the motor running** at various speeds with an assistant holding the model, using hand signals to show you what is happening. If the control surfaces do not respond correctly, **do not fly!** Find and correct the problem first. Look for loose servo connections or broken wires, corroded wires on old servo connectors, poor solder joints in your battery pack or a defective cell, or a damaged receiver crystal from a previous crash.

**Note:** If the radio appears to be affected only when the motor is running, it is possible that the electric motor is causing radio interference. If this happens, you may try installing a .01  $\mu\text{F}$  capacitor between the motor leads, then repeat the range check with the motor running.

## ***PERFORMANCE TIPS***

### ***Cycle the Batteries***

For the longest flight duration, and to get the most from a new battery, the battery should be cycled. “Cycling” a battery means to fully charge (“peak” charge) the battery, then to discharge it (never **fully** discharge a battery). Many battery chargers have peak charging and automatic discharging capabilities. If you do not have a charger that is able to discharge batteries, you can discharge the battery yourself by running the motor with the propeller attached until the propeller barely continues to turn. Charge and discharge the battery 3 or 4 more times on the ground before flying. Be sure to remove the battery from the airplane between each cycle and allow it to cool before recharging.

## ***Examine the Propeller***

Use fine sandpaper to remove imperfections along the edges of the propeller. For the best performance, use a Top Flite Precision Magnetic Prop Balancer™ (TOPQ5700) to balance the propellers (this is a necessity on glow-powered engines, but less critical on small electric models).

## ***Motor Care***

1. Using multiple battery packs for successive flights may cause the motor to become excessively hot, thus causing damage. Allow the motor to cool for at least 10 minutes between flights.

2. The ideal power source for the BLT system is a 6 to 7-cell (7.2 - 8.4 volt) battery pack. The use of a higher voltage battery may reduce motor life.

## ***Oil the Wheels***

If taking off from the ground, the wheels must spin freely. Check the wheels for binding when moved from side to side and put a drop of oil on each axle.

## ***Motor Safety Precautions***

**Note:** Failure to follow these safety precautions may result in severe injury to yourself and others.

Get help from an experienced pilot when learning to operate motors.

Use safety glasses when running motors.

Do not run the motor in an area of loose gravel or sand; the propeller may throw such material in your face or eyes.

Keep your face and body as well as all spectators away from the path of the propeller as you start and run the motor.

Keep items such as these away from the prop: loose clothing, shirt sleeves, ties, scarfs, long hair or loose objects (pencils, screw drivers) that may fall out of shirt or jacket pockets into the prop.

The electric motor and motor battery used in your Basic Light Trainer is very powerful and the spinning propeller has a lot of momentum; therefore, if you touch the propeller while it is spinning it may inflict severe injury. Keep this in mind, respect the motor and propeller for the damage it is capable of and take whatever precautions are necessary to avoid injury. Always disconnect and remove the motor battery until you are ready to fly again and **always make sure the switches are turned off before connecting the battery.**

## ***AMA Safety Code (excerpts)***

Read and abide by the following Academy of Model Aeronautics Official Safety Code:

### **GENERAL**

1. I will not fly my model aircraft in competition or in the presence of spectators until it has been proven to be airworthy by having been previously successfully flight tested.

2. I will not fly my model aircraft higher than approximately 400 feet within 3 miles of an airport without notifying the airport operator. I will give right of way to and avoid flying in the proximity of full scale aircraft. Where necessary an observer shall be utilized to supervise flying to avoid having models fly in the proximity of full scale aircraft.

3. Where established, I will abide by the safety rules for the flying site I use and I will not willfully and deliberately fly my models in a careless, reckless and/or dangerous manner.

7. I will not fly my model unless it is identified with my name and address or AMA number, on or in the model.

### **RADIO CONTROL**

1. I will have completed a successful radio equipment ground check before the first flight of a new or repaired model.

2. I will not fly my model aircraft in the presence of spectators until I become a qualified flyer, unless assisted by an experienced helper.

3. I will perform my initial turn after takeoff away from the pit, spectator and parking areas and I will not thereafter perform maneuvers, flights of any sort or landing approaches over a pit, spectator or parking area.

4. I will operate my model using only radio control frequencies currently allowed by the Federal Communications Commission.

## ***Find a Safe Place to Fly***

Though the BLT is a "Park Flyer," the **best** place to fly **any** model is at an AMA chartered club field. Club fields are designed for R/C flying making your outing safer and more enjoyable. We recommend that you join the AMA and a local club so you can have a safe place to fly and have insurance to cover you in case of a flying accident. The AMA address and telephone number are in the front of this manual.

If there is no club or R/C flying field in your area, find a suitable site that is clear of trees, telephone poles, buildings, towers, busy streets and other obstacles. Since you are not flying at a sanctioned AMA site, be aware that

there may be others like yourself who could be flying nearby. If both of your models happen to be on the same frequency, interference will likely cause one or both of the models to crash. An acceptable minimum distance between flying models is five miles, so keep this in mind when searching for a flying site.

In addition to obstacles, it is important to be aware of people who may wander into the area once you begin flying. At AMA club flying sites it is a severe rule infraction to fly over others, and this is a good rule to follow if flying elsewhere. Please be aware, R/C models tend to attract interested onlookers. Onlookers pose two main problems. First is the danger of actually crashing your model into a person, causing injury. Second is the distraction of those who ask you questions while you are trying to concentrate on flying. To minimize or avoid this problem, have an assistant standing by who can spot people who wander into your flying site (so you can avoid flying over them) and who can perform "crowd control" if people start to gather.

## FLYING

**IMPORTANT:** If you are an inexperienced modeler we strongly urge you to seek the assistance of a competent, experienced R/C pilot to check your model for airworthiness AND to teach you how to fly. No matter how stable or "forgiving" the BLT is, attempting to learn to fly on your own is dangerous and may result in destruction of your model or even injury to yourself and others. Therefore, find an instructor and fly only under his or her guidance and supervision until you have acquired the skills necessary for safe and fully controlled operation of your model.

## Takeoff

We recommend flying the BLT when the wind is no greater than five miles per hour. Less experienced flyers should fly the BLT only in calm (less than one mile per hour) conditions. Frequently, winds are calm in the early morning and early evening. Often these are the most enjoyable times to fly anyway!

Until you have the BLT properly trimmed for level flight, we recommend having an assistant hand-launch the model instead of taking off from the ground.

Turn on the transmitter and plug the battery into the speed control.

**IMPORTANT:** Confirm that the transmitter operates the controls by moving the sticks and watching the surfaces

respond. Occasionally, electric models have been launched with the transmitter turned off or the battery disconnected from the speed control!

When ready to launch, the assistant should hold the bottom of the fuselage behind the landing gear, then raise the model high above his head and point it **into the wind**. With the pilot (*that would be you!*) standing behind the plane, fully advance the throttle to start the motor. As soon as the motor is at full power, the hand launcher should gently toss the plane into the air at a **level** or **slightly** nose-up attitude. Be certain the model is being launched **into** the wind and be immediately ready to make corrections to keep the airplane flying straight, level and into the wind.

When the model has gained adequate flying speed under its own power, **gently** pull the elevator stick back until the airplane starts a gradual climb. Many beginners tend to pull too hard causing the model to stall, so be gentle on the elevator and don't panic. If you do pull too hard and you notice the model losing speed, release the elevator stick and allow the model to regain airspeed.

Continue a **gradual** climb and establish a gentle turn (away from yourself) until the airplane reaches an altitude of 75 to 100 feet.

## Flight

The main purpose of the first few flights is to learn how the model behaves and to adjust the trims for level flight. After the model has climbed to a safe altitude reduce the throttle slightly to slow the model, yet maintain altitude. The BLT should fly well and maintain adequate airspeed at about half to 3/4 throttle.

Adjust the elevator trim so the model flies level at the throttle setting you are using. Adjust the rudder trim to level the wings. It may take a few passes to get the trims adjusted, but this should be your first priority once at a comfortable altitude. Continue to fly around, executing turns and making mental notes (or having your assistant take notes for you) of what additional adjustments or C.G. changes may be required to fine tune the model so it flies the way you like.

If the BLT reaches a high enough altitude, you may periodically cut off the motor power and glide. This may extend the flight time by several minutes, especially if you fly into a rising air current.

## Landing

Because the BLT flies slowly, it requires little room to land. Begin the landing approach by flying downwind at an altitude of approximately 20 feet [6 meters]. When the airplane is approximately 50 to 100 feet [15 to 30 meters] past you, reduce the motor power and make the “final” 180-degree turn into the wind aligning the airplane with the runway or landing area. Do not dive the airplane, as it will pick up too much speed. Instead, when you cut the power, allow the airplane to establish a gradual descent. Concentrate on keeping it heading into the wind toward the runway. When the plane reaches an altitude of about 4 feet [1 meter], gently apply a little “up elevator” to level the plane, but be careful as too much up elevator will cause it to stall. While holding a slight amount of up elevator the airplane will slow and descend as it loses flying speed, thus touching down on the runway. For a smoother landing, use a slight amount of motor power.

Some battery power should be reserved to help maneuver the plane for landing.

## ROG (Rise off Ground) Takeoff

When speaking of small models, frequently a takeoff from the ground is called an “ROG” (*rise off ground*) takeoff. Landings on grass will be a little rough, but doing a ROG takeoff from grass will probably not be possible with the BLT. If planning an ROG takeoff, find a paved surface.

After you have trimmed the BLT for flight and have become familiar with its flight characteristics, you may execute ROG takeoffs. With the model on the runway and pointing into the wind, gently apply power. Initially, the plane may turn to the left or right because it has not gained enough speed for the controls to become effective. Do your best to get through this brief moment and maintain a heading down the runway and into the wind. Make corrections with the right stick of the transmitter to keep it rolling straight into the wind. If the model veers too far off, cut the throttle and try again. As the model begins to gain speed the controls will become effective.

After the airplane has gained adequate speed (this requires experience to gauge), gently pull back on the elevator stick allowing the airplane to become airborne. Establish a gentle climb the same as when you were hand-launching.

**Best of luck and happy flying!**

Use these tags to identify your models.

This model belongs to:

---

Name

---

Address

---

City, State Zip

---

Phone number

---

AMA number

This model belongs to:

---

Name

---

Address

---

City, State Zip

---

Phone number

---

AMA number

This model belongs to:

---

Name

---

Address

---

City, State Zip

---

Phone number

---

AMA number

TWO VIEW

