

# SHOCK 3D

## ARF



### **WARNING**

A radio-controlled model is not a toy and is not intended for persons under 16 years old. Keep this kit out of the reach of younger children, as it contains parts that could be dangerous. A radio-controlled model is capable of causing serious bodily injury and property damage. It is the buyer's responsibility to assemble this aircraft correctly and to properly install the motor, radio, and all other equipment. Test and fly the finished model only in the presence and with the assistance of another experienced R/C flyer. The model must always be operated and flown using great care and common sense, as well as in accordance with the Safety Code of the Academy of Model Aeronautics (5151 Memorial Drive, Muncie, IN 47302, 1-800-435-9262). We suggest you join the AMA and become properly insured prior to flying this model. Also, consult with the AMA or your local hobby dealer to find an experienced instructor in your area. Per the Federal Communications Commission, you are required to use only those radio frequencies specified "for Model Aircraft."

### **LIMITED WARRANTY**

Carl Goldberg Products, Ltd. has inspected and certified the components of this aircraft. The company urges the buyer to perform his own inspection, prior to assembly, and to immediately request a replacement of any parts he believes to be defective for their intended use. The company warrants replacement of any such components, provided the buyer requests such replacement within a period of 30 days from the date of purchase and provided the defective part is returned, if so requested by the company.

No other warranty, expressed or implied, is made by the company with respect to this kit. The buyer acknowledges and understands that it is his responsibility to carefully assemble the finished flying model airplane and to fly it safely. The buyer hereby assumes full responsibility for the risk and all liability for personal or property damage or injury arising out of the buyer's use of the components of this kit.

---

## CARL GOLDBERG PRODUCTS, LT

---

© Copyright Carl Goldberg Products, Ltd. 2004

P.O. Box 88 Oakwood GA 30566 Phone #678-450-0085 Fax # 770-532-2163 [www.carlgoldbergproducts.com](http://www.carlgoldbergproducts.com)

## USING THIS INSTRUCTION MANUAL

Before you begin assembling your **Shock 3D ARF**, take some time to read through this entire instruction book. It is designed to take you step-by-step through the process and to give you added information on motor and radio selection and set-up, balancing your aircraft, and flying your model. The time you spend will speed the assembly process and help you avoid problems.

## PREPARING FOR ASSEMBLY

You will need a work area of approximately 24 x 48" which has been covered to protect it from adhesive, as well as cuts and other damage. Many people cover their work area with a sheet of dry wall (sheet rock) and/or waxed paper to prevent CA Glue and Epoxy from ruining the work surface.

## CONSTRUCTION TIPS

**IMPORTANT: ALWAYS READ A FEW STEPS AHEAD.** This will alert you to coming instructions and will help you plan accordingly.

Using the Parts Identification section, familiarize yourself with the various items included in your kit box.

Do not hesitate to ask questions. Your local hobby dealer and area flyers will most likely be happy to help, as they want you to have a successful flying experience.

You may also receive technical assistance from Carl Goldberg Products, Ltd. via e-mail ([questions@carlgoldberg-products.com](mailto:questions@carlgoldberg-products.com)) or by telephone 1-678-450-0085.

## ADHESIVES & GLUING TECHNIQUES

CA adhesives are specially formulated to firmly glue the plywood, hardwood, and balsa used in your model and to withstand the vibration and stresses of high performance flight. However, there are times, such as when you are installing the stabilizer and fin on the fuselage and want more set-up time for careful alignment and positioning, then you should use epoxy. Occasionally, you also will want to use thin CA, which "wicks" into the surrounding areas. Aliphatic resin glue or similar water-based glues can also be used, but they will add to the assembly time because they dry so much more slowly than CA glue. Remember, when ever using any CA, you must be careful to read instructions thoroughly, as you will have only seconds for positioning of parts. Be sure to trial fit parts together before gluing. Also, never use watery THIN type CA glue for gluing plywood and hardwood parts. Thin CA's do not adequately bond these areas.

## CAUTION

Some people may experience an allergic reaction when exposed to fumes from CA glue or epoxy. As with paints, thinners, and solvents, it is always important to use glues only where there is adequate ventilation to carry fumes away. A fan is recommended. Also, special care must be taken when using CA, as it will bond skin as well as other surfaces. Before using any CA, carefully read all label precautions. When using CA, protective eye-wear and care in keeping the glue away from the face is highly recommended. If CA does happen to get into the eye, hold lid open and flush with water only. Seek immediate medical attention.

## COVERING

The Shock 3D ARF is covered in a premium polyester film chosen by many of the world's top flyers for its beauty, toughness, and ease of application and repair. It is not uncommon for ARF's to develop a few wrinkles in transit. If this is true of your model, the situation is easily corrected. Before you begin putting the pieces together, run around the edge of the seams first then over the surface of each section with an iron (either specially designed for airplane use or the more cumbersome household iron). Apply the heat (set at about 350° F), following along with a soft cloth and pressing down on the covering as you go around. This will more firmly set the covering adhesive into the wood and keep your aircraft covering tight and smooth in the future. Once you have ironed the seams stay away from them with the heat or the covering will slide when you try to shrink the middle. If this happens the wrinkles will not come out of the covering.

One of the great advantages of polyester film is that it can be applied over itself without causing gas bubbles. This allows you to repair your aircraft, as well as to customize it in a number of ways. If, due to a flight mishap, you get a hole or similar covering damage, simply trim away the ragged edges and then apply a patch, following the directions that come with your covering, which is available at your hobby dealer.

### The Shock 3D covering can be matched using

Oracover Black 874

Oracover White 870

Oracover Yellow 872

Oracover Red 883

## ITEMS NEEDED TO COMPLETE THIS AIRCRAFT

- 1 RADIO GUIDANCE SYSTEM (4 CHANNEL MINIMUM REQUIRED WITH 4 SERVOS)
- 1 6" SERVO "Y" HARNESS
- 1 ELECTRONIC SPEED CONTROL (ELECTRIC FLY C-20 FROM GREAT PLANES SUGGESTED)
- 1 NIMH 7C 650AAA BATTERY (2 OR 3 CELL 2100 MAH LI-PO BATTERY SUGGESTED)
  
- 1 CA ACCELERATOR
- 1 1 OZ. BOTTLE CA MEDIUM GLUE
- 1 1/2 OZ. BOTTLE CA THIN GLUE
- 1 5 MINUET EPOXY
- 1 1/4" FOAM RUBBER
- 1 400 SIZE MOTOR OR BRUSHLESS MOTOR EQUIVALENT
- 1 6 TO 1 GEAR DRIVE

## TOOLS AND SUPPLIES FOR ASSEMBLY.

- MODELING OR UTILITY KNIFE
- WORK SURFACE (24" X48")
- SMALL STANDARD & PHILLIPS SCREW-DRIVERS
- MASKING TAPE
- NEEDLE NOSE PLIERS
- 24" RULER
- FLEXIBLE STRAIGHT-EDGE
- 30-60-90° x 6" TRIANGLE
- SOFT PENCIL
- A FEW STRAIGHT OR "T" PINS
- WIRE CUTTER (DYKES)
- OPTIONAL HEAT GUN/COVERING IRON
- ACID BRUSH
- 5 FT. LENGTH OF STRING

# Caution:

**Before starting, carefully go over all high stress areas with an epoxy or wood glue to confirm all areas are well glued.**

## IMPORTANT INFORMATION

Covering coming loose is not **COVERED UNDER WARRANTY**. Due to temperature changes the plane may develop some wrinkles in the covering that you will need to remove with an iron. Be sure to seal the edges down first so that you do not cause the covering to shrink and leave exposed areas of wood. Please inspect the plane before beginning to assemble to make sure you are happy with it. After assembly has begun you cannot return the kit. If you find a problem before beginning to assemble the plane you must contact us, please do not return it to the dealer.

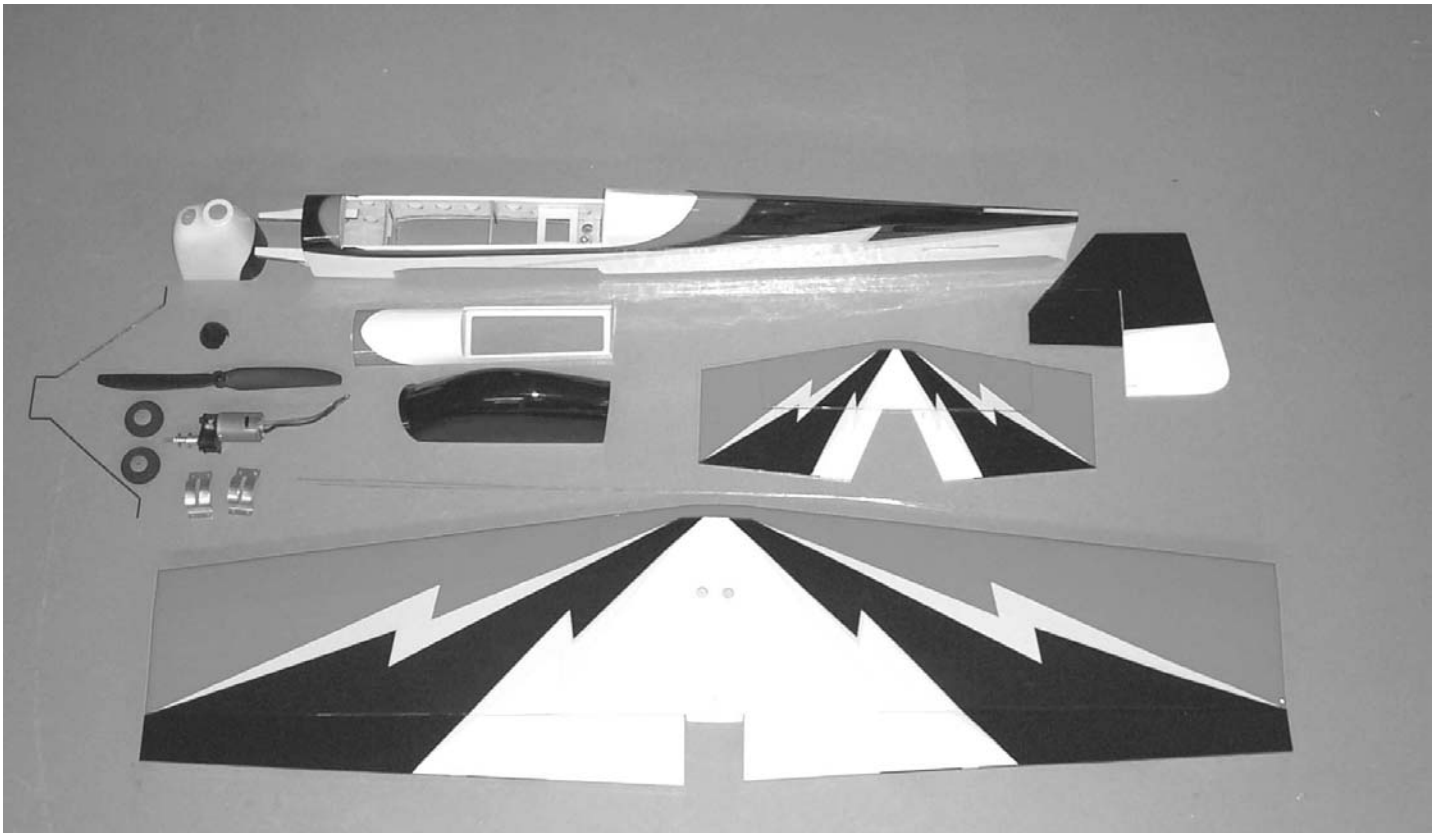

**Parts List  
(Shown Above)**

1. Fuselage
2. Wing with Ailerons
3. Stab with Elevators
4. Fin
5. Rudder
6. Canopy
7. Hatch Cover
8. Cowl
9. Landing Gear
10. (2) Wheels
11. Prop (not included)
12. Spinner(not included)
13. Motor with Gear Drive(not included)
14. Motor mounts(not included)

**Hardware  
(Not Shown)**

**Wing**

- (2) laser cut control horns
- (2) nylon swing in keepers
- (2) 1/32 x 5-1/2" pushrods
- (1) 4-40 x 3/4" socket head bolt
- (1) #4 flat washer
- (2) Pushrod connectors

**Stab and Rudder**

- (2) laser cut control horns
- (1) elevator joiner wire
- (7) CA hinges
- (2) nylon swing in keepers
- (2) pushrod connectors
- (2) 1/32 x 24" pushrods

**Landing Gear**

- (1) Main landing gear
- (2) wheels
- (2) plastic wheel retainers
- (1) tail skid wire
- (1) landing gear cover plate

**Motor Mount**

- (1) 3/8" square spruce optional motor mount

**Cowl Mounting**

- (2) plated #2 x 1/4 screws
- (2) black #2 x 1/4 screws

# Wing

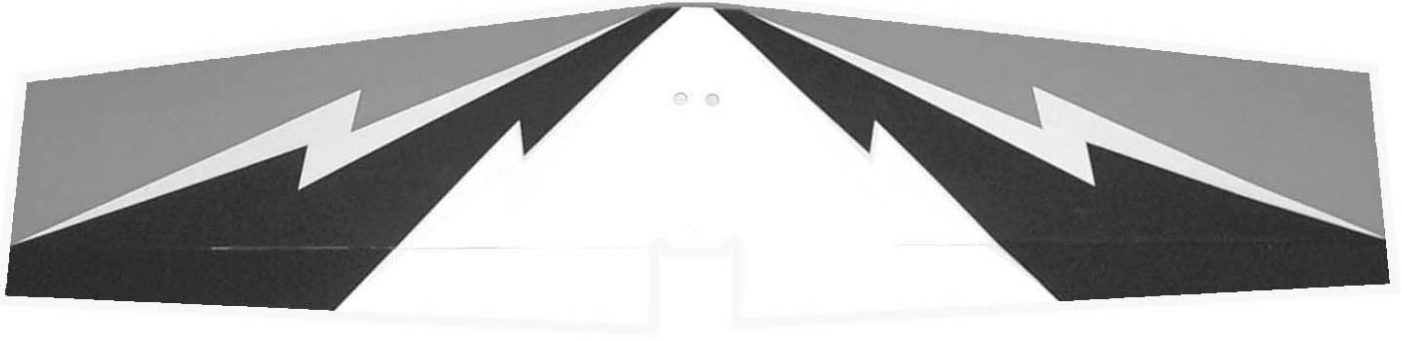

The wing for the Shock 3D comes pre-assembled with the ailerons already hinged. All that is required to finish the wing is to install the aileron servos, control horns and attach the pushrods.

## AILERON SERVO INSTALLATION



1.  Collect the following parts:
  - (2) servos with mounting hardware(not supplied)
  - (1) 6" y-connector(not supplied)
  - (1) piece of string, soft wire, or cable tie(not supplied)
  - (2) laser cut control horns
  - (2) 1/32" x 5-1/2" wire pushrods
  - (2) mini pushrod connectors

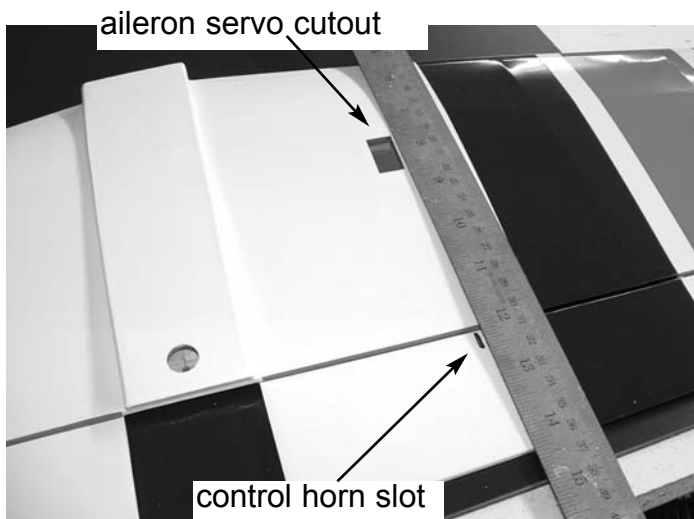

2.  Locate the control horn slot by laying a straight edge along the outside edge on the servo opening. The slot is pre-cut in the aileron but is covered over with the film.



3.  Use an X-acto knife or razor blade and remove the covering over the control horn opening. Do this on both sides of the aileron.

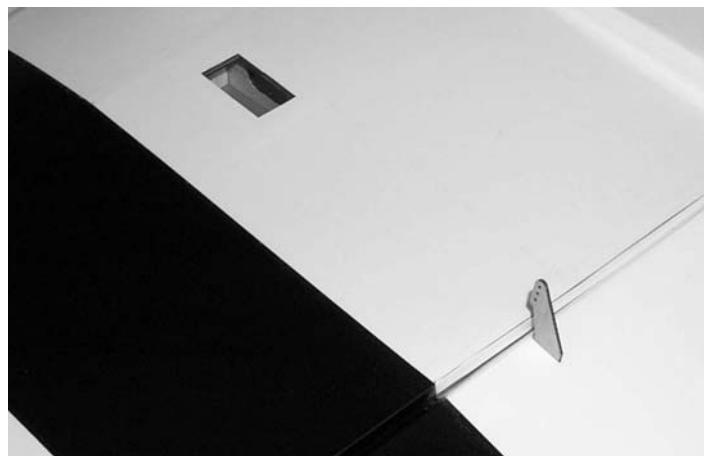

4.  Install the control horn in the slot making sure that it is about 1/32" past the top surface of the aileron. Make sure the holes are aligned over the hinge line of the aileron.

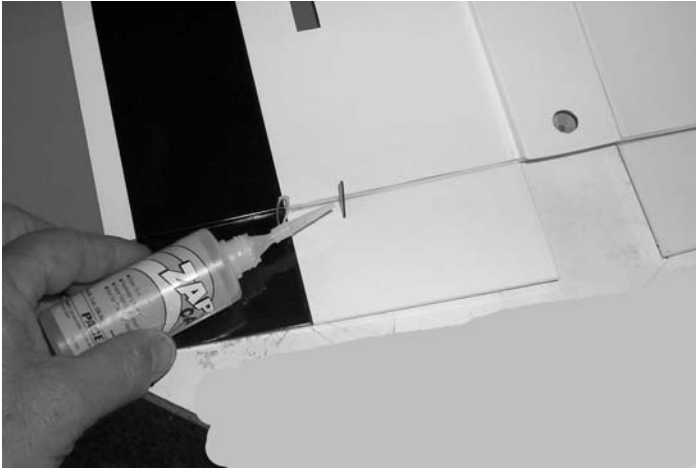

5.  Using thin CA, apply one drop on each side of the control horn.



6.  Flip the wing over and glue the aileron horn from the top side of the wing using thin CA.

7.  Repeat for the other aileron.

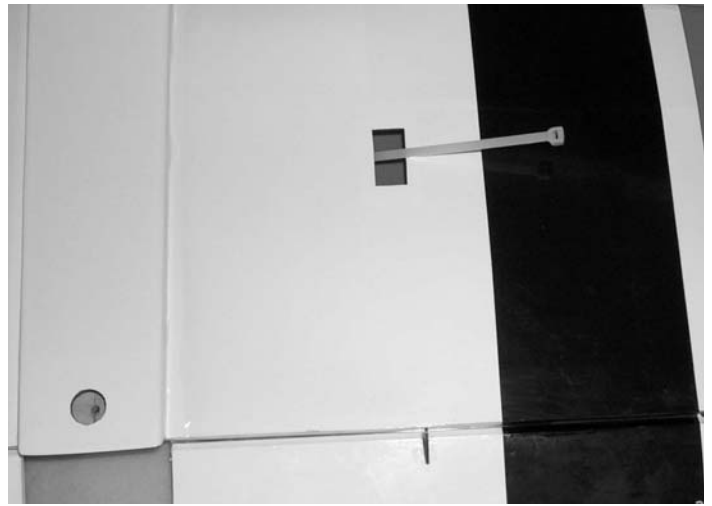

8.  Locate the string, soft wire or a cable tie. Push it into the aileron servo cut out and fish it out the hole in the middle of the wing on the top side.

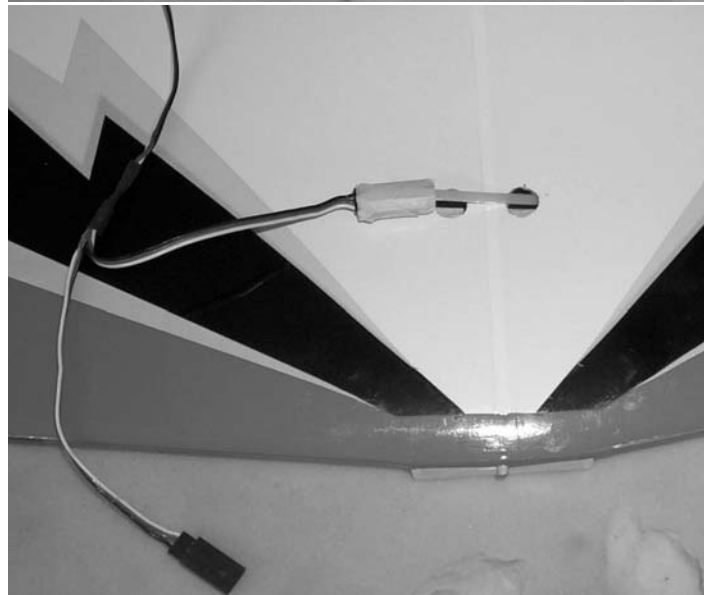

9.  Tape one leg of the servo y-connector to the cable tie, string or soft wire.

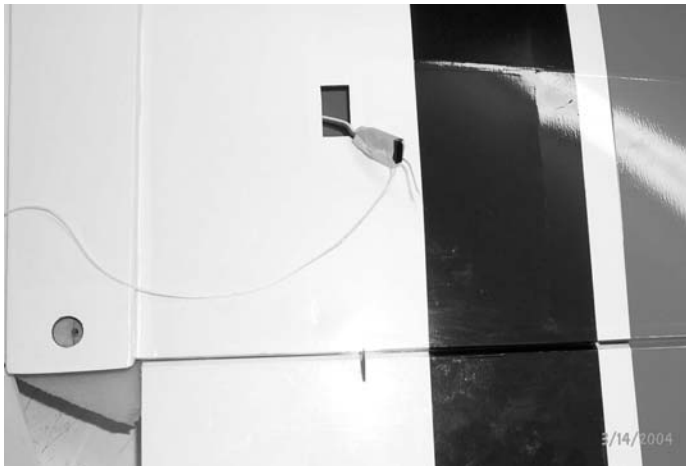

10.  Carefully pull the aileron y-connector through to the servo opening.

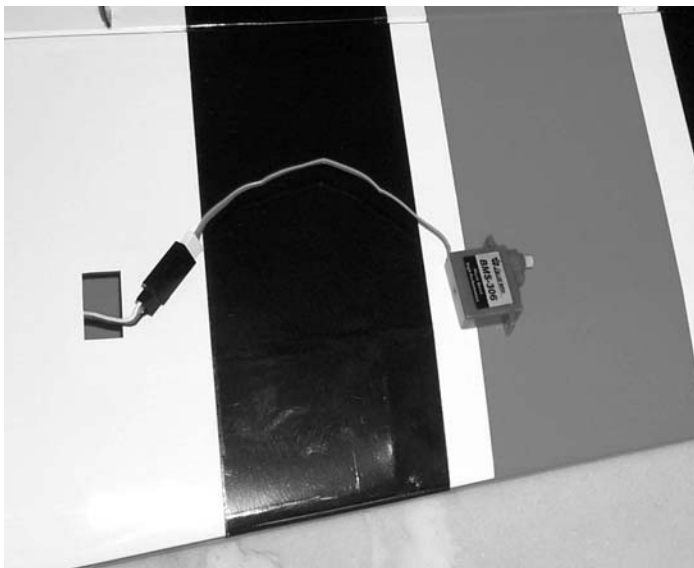

11.  Plug the aileron servo into the y-connector. Use tape on the plug to make sure it does not come loose.

12.  Pull the aileron y-connector back into the wing and seat the servo in the opening.



13.  Screw the servo in place using the hardware supplied with the radio.



14.  Install the pushrod connector on your servo arm. The plastic push-on nut will retain it.

**Caution:**  
**Make sure the nylon nut is pushed all the way onto the pushrod connector.**

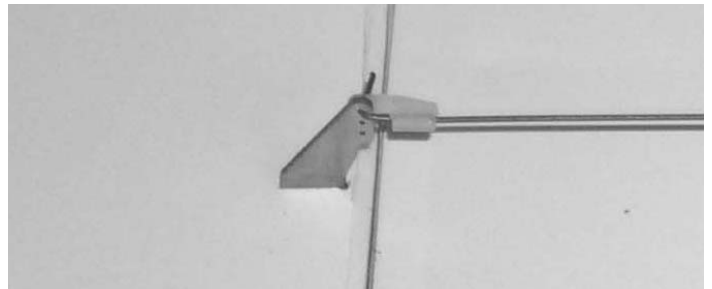

15.  Make a 90 degree bend 1/4" long in the end of one of the 1/32 x 5-1/2" wires and install in the control horn. Use the nylon swing in keeper to retain the wire.

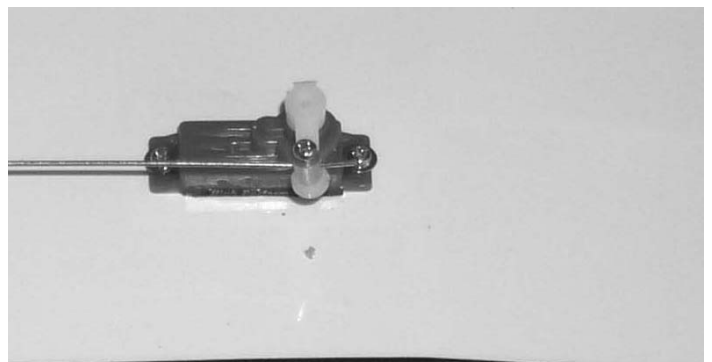

16.  Insert the other end of the pushrod in the pushrod connector you installed on the servo arm. Install the arm on the servo. Center the servo with the radio and center the aileron. Tighten the screw on the servo connector. Install the screw to retain the servo arm on the servo. Cut the excess wire off the pushrod.

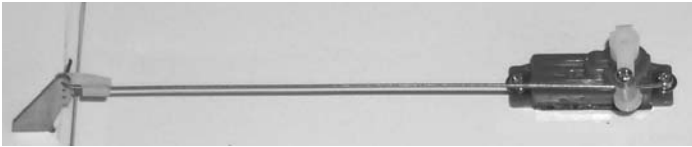

- Repeat for the other aileron servo.

## Stabilizer Mount

1.  Collect the following items.
  - (1) stabilizer
  - (1) right elevator
  - (1) left elevator
  - (2) laser cut control horns
  - (1) fuselage
  - (1) wing
  - (1) wing bolts 4-40 x 3/4"
  - (1) elevator joiner wire
  - (4) CA hinges

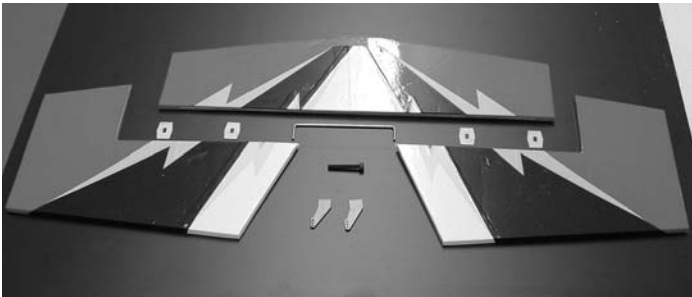

**Caution:**  
install the elevator joiner wire first.



2.  Slide the elevator joiner wire into the slot for the stab. You cannot install it after the stab is in place without cutting the fuselage.

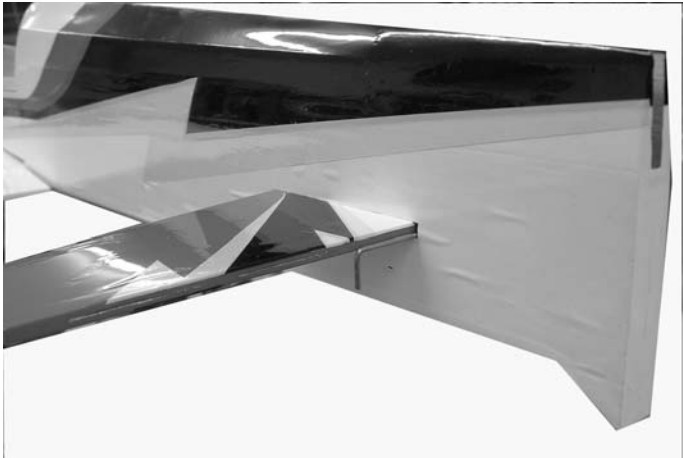

3.  Slide the stab into the precut slot in the fuselage. Measure each side at the trailing edge to make sure it is centered.

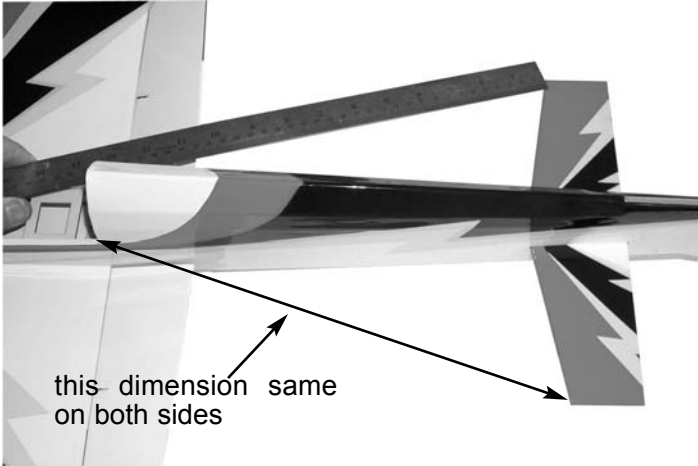
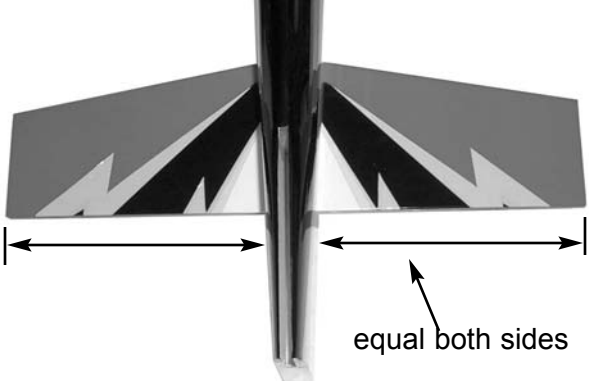

4.  Use a ruler and measure from the tip of the stab to the front of the turtle deck and make sure the dimension is the same on both sides. When you have this the same the stab will be square with the fuselage.



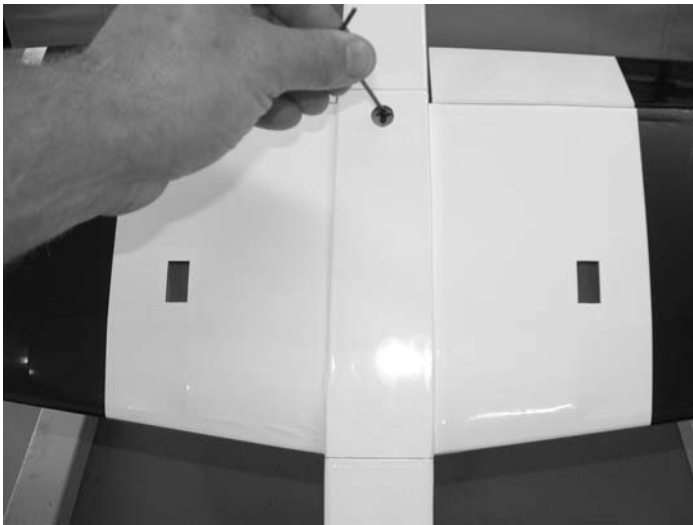

5. □ Bolt the wing in place using the 4-40 x 3/4" socket head screw.

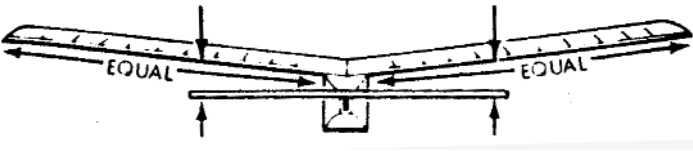

6. □ Sight the stab from the rear and make sure that it is parallel with the wing. If required, remove a small amount of material from the stab saddle to make the stab align with the wing.

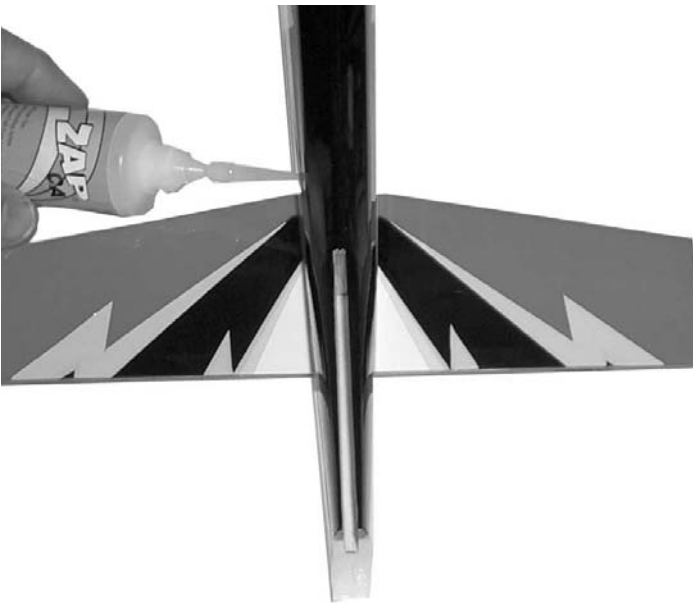

7. □ When satisfied with the fit, glue in place using thin CA. Apply to both top and bottom and on both sides of the fuselage. Be careful that it does not run out of the fuselage and onto the stab.

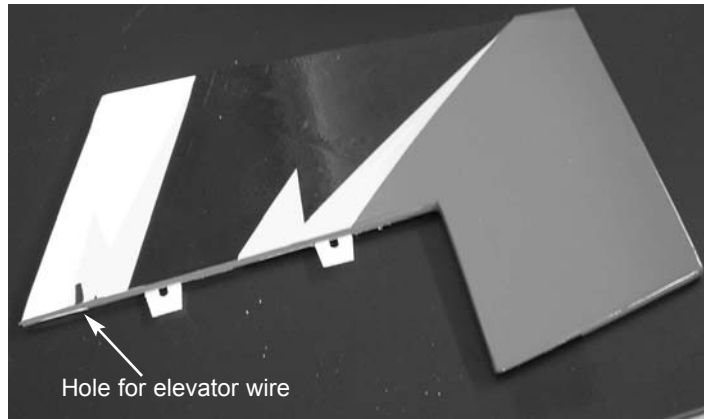

8. □ Take one elevator half and install two CA hinges in the pre-cut slots. Locate the hole for the elevator joiner wire.

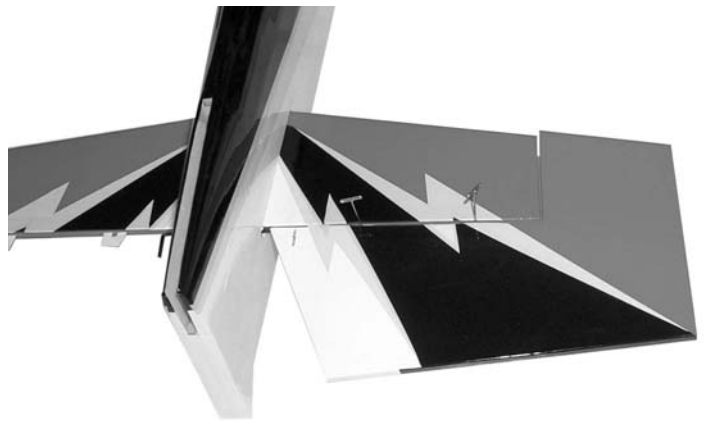

9. □ Put epoxy or white glue in the hole for the elevator joiner wire and fit the elevator to the stab. Use pins in the middle of the hinge to make sure the hinge stays centered in the stab and elevator. Leave 1/32" gap at the elevator counter balance.



10.  Remove the pin and push elevator tight against the stab. Deflect the elevator to its full travel in the down position. Apply one drop of thin CA on each hinge.

Turn the plane over and put one drop of CA on each hinge from the bottom side.

Go back and put one drop of CA on each hinge top and bottom again.

11.  Repeat for the other elevator. Before gluing in place make sure that both elevators are even when installed on the joiner wire. If necessary bend joiner wire till both elevators are level with one another.

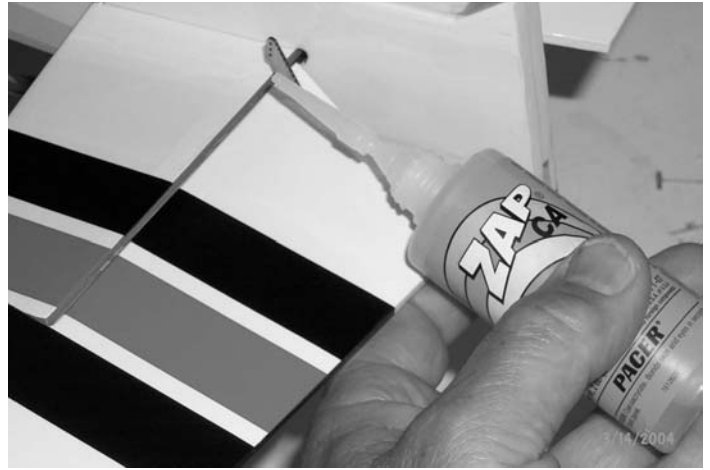

13.  Glue in place using thin CA. Glue on top and bottom.

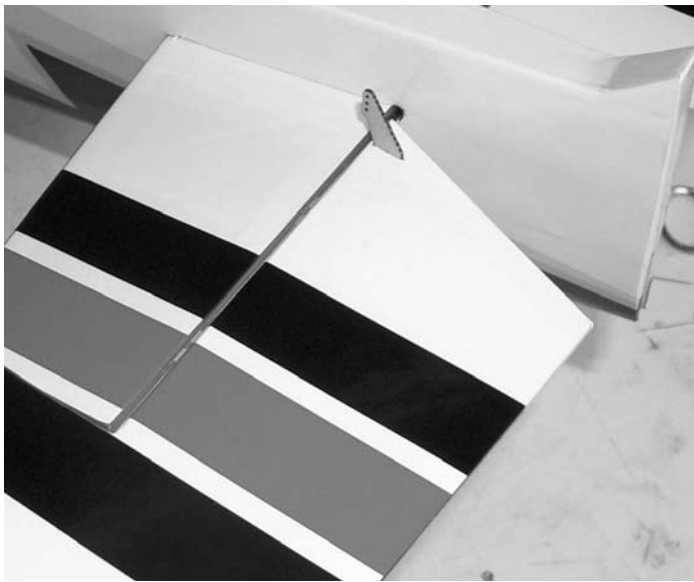

12.  Locate the slot for the elevator control horn on the right elevator half. The slot is pre-cut in the wood but covered over by the covering. Remove the covering with an x-acto knife or razor blade.

Install the control horn making sure the holes for the pushrod are aligned over the hinge line. The control horn should extend past the top surface of the elevator  $1/32''$ .

### Fin And Rudder Installation



1.  Locate the following parts.

(1) fin

(1) rudder

(3) CA hinges

(1) laser cut control horn



2.  Insert fin in the slot on top of fuselage and glue in place using thin CA.



3.  Locate the rudder and install 3 CA hinges, do not glue yet.
- Locate the slot for the control horn and remove covering from pre-cut slot.
- Insert the control horn making sure that it extends 1/32" through the other side and that the holes are aligned with the hinge line. The control horn should be on the left side of the plane.
- Glue the control horn in place using thin CA, glue on both sides.



4.  Install the rudder on the plane using straight pins to make sure the hinges stay centered just as we did with the elevators.
- Deflect the rudder in one direction to its full travel and put one drop of thin CA on each hinge. Move the rudder to full deflection in the other direction and glue each hinge.
- Repeat the gluing so each hinge gets two drops.

### Elevator, Rudder Servo Pushrod Installation

1.  Collect the following items:
  - (2) servos with hardware(not supplied)
  - (2) 1/32" x 24"
  - (2) pushrod connectors
  - (2) nylon swing in keepers



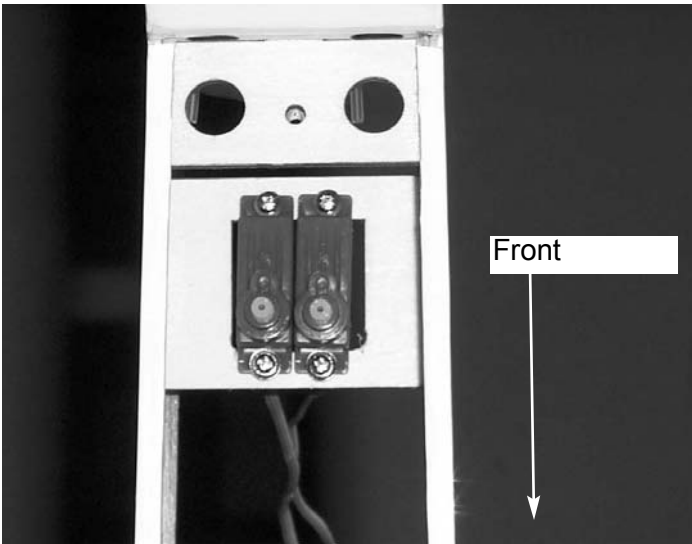

2.  Install the two servos using the hardware supplied with the radio. The output shafts should be to the front of the plane.



3.  Bend a 90 degree angle 1/4" long in the end of one of the 1/32" x 24" pushrods.  
 Insert the wire in the pre-installed tube in the fuselage. You may have to remove the covering over the hole.  
 Turn the plane over and bend and install the rudder pushrod.

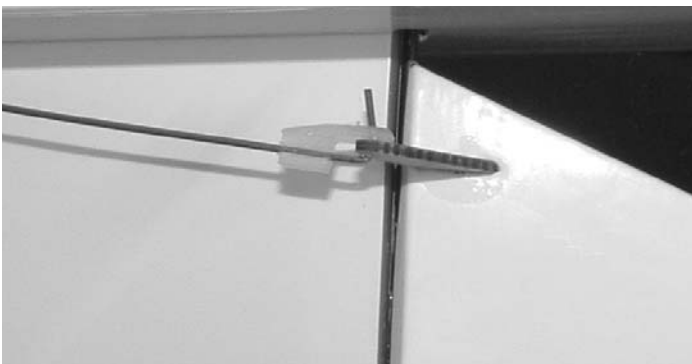

4.  Use the nylon swing in keepers to retain the pushrod on the control horns.



5.  Install the two pushrod connectors on the control arms of the rudder and elevator servo as you did for the ailerons.

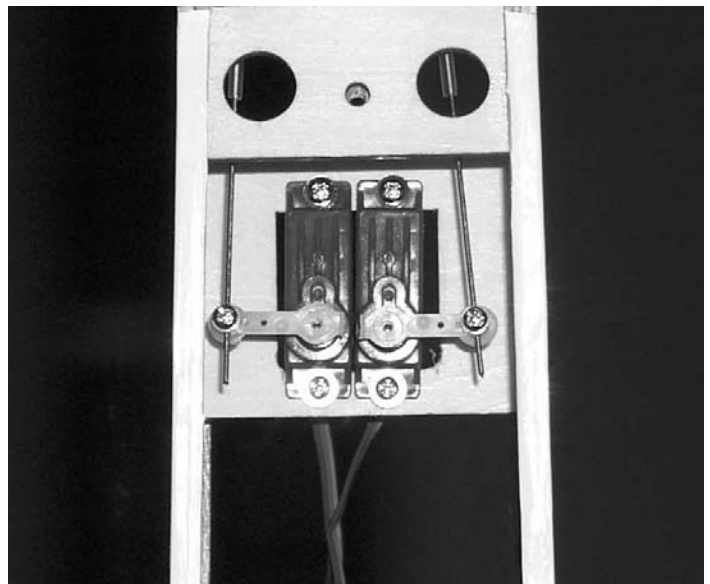

6.  Put the pushrod in the hole in the pushrod connector and install arm on servo. Center the servos with the radio and make sure the rudder and elevator are centered. Tighten the screw firmly. Cut the excess pushrod off leaving about 1/2" past the connector. Don't forget to put the screw in the servo arm.

## Landing Gear Installation

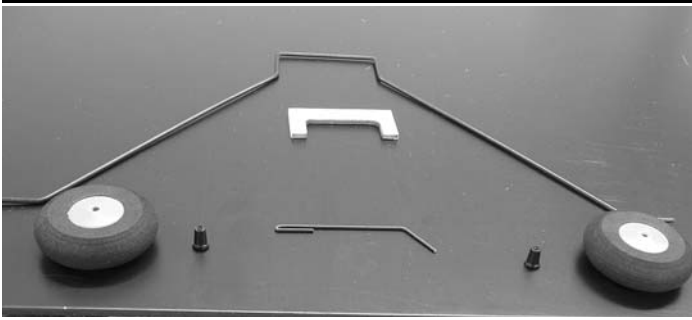

1.  Collect the following items:
  - (1) Landing gear
  - (2) Wheels
  - (2) plastic wheel retainers
  - (1) tail skid wire
  - (1) Landing gear cover



2.  Remove the covering from the landing gear slot at the leading edge of the wing.

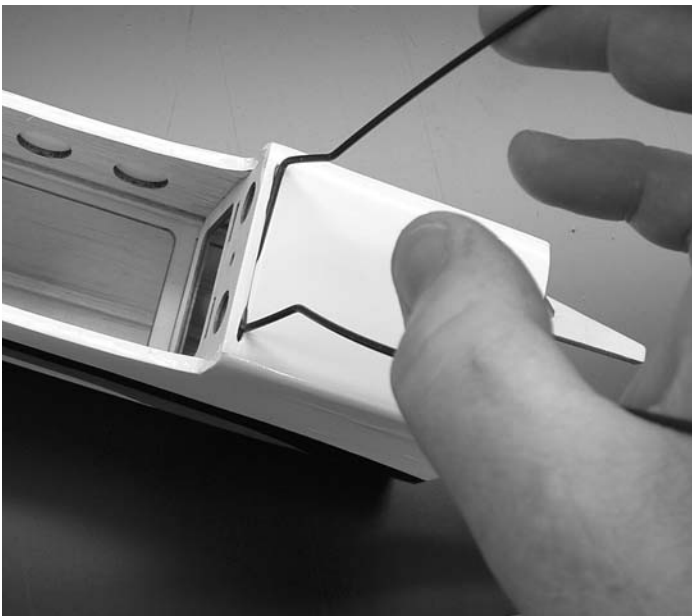

3.  Flex the landing gear legs together slightly and slide in the opening. Push all the way in.

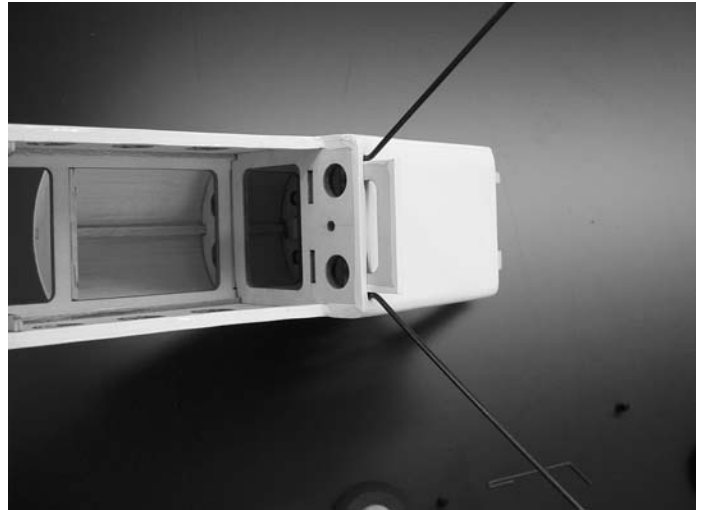

4.  Take the landing gear cover plate and press into the slot on top of the gear. It is not necessary to glue in place.

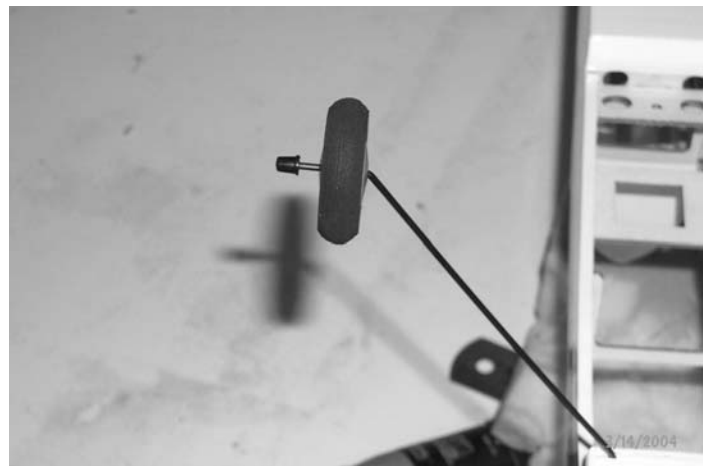

5.  Slide the wheel on the axle and retain with the plastic press on keeper.
  - Repeat for the other wheel.

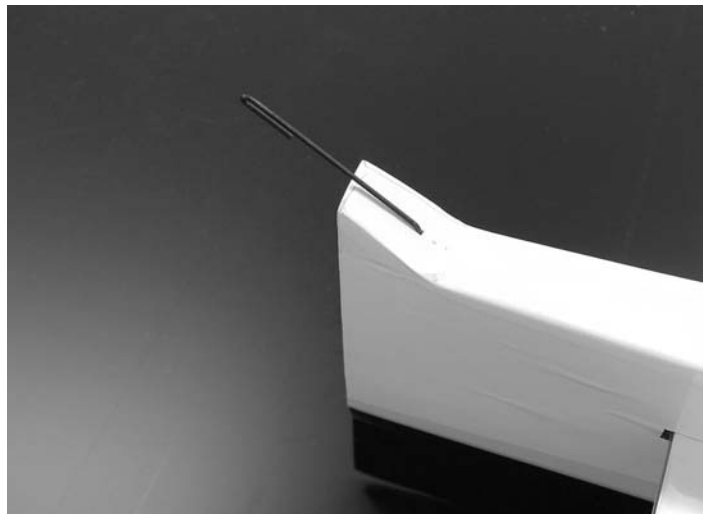

6.  Drill a 1/32" hole in the tail skid mount 1/2" from the end. Insert the tail skid and cut a slot for the wire to fit into. Glue in place with medium CA.

### Motor Mount

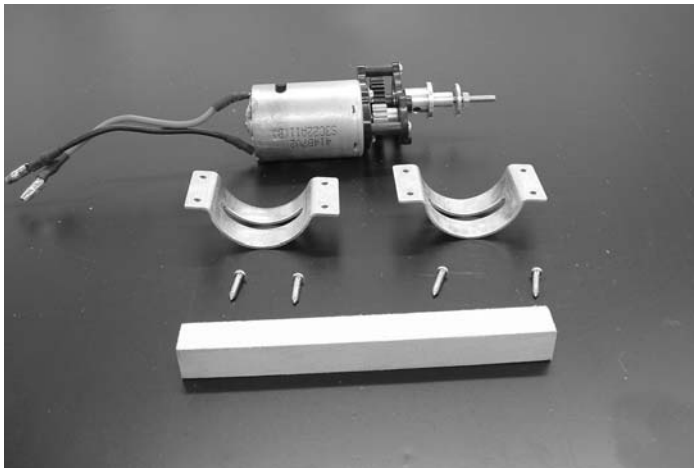

1.  Collect the following parts:
- (1) motor and gear box assembly
  - (2) motor mounts( clam shell metal)
  - (4) #2 x 1/2" sheet metal screws
  - (1) 3/8" square x 3-5/8" spruce motor mount

### Note:

**Motor, motor mounts and gear box shown for reference only, not included in kit.**

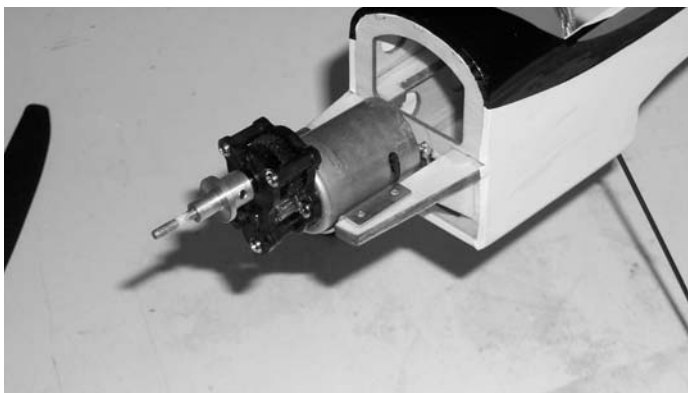

2.  Set the bottom clam shell mount between the beams and 1/8" back from the front edge.
- Mark the mounting hole location on the beams and drill a 1/16" hole at each of the 4 spots.
- Set the motor in place, pass the wires through the firewall in the hole provided.



3.  Place the top shell in place and secure using the four #2x1/2" screws.

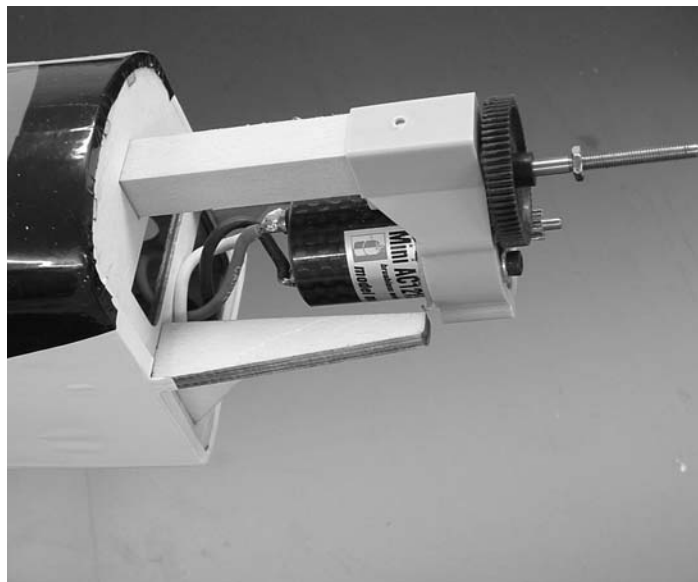

4.  An optional motor mount is supplied to mount the popular beam mount gear drives. Fit the 3/8" square spruce beam in the holes provided in the firewall and the second bulkhead. Glue in place with medium CA.
- The drive shown is a GWS EP350C with D gearing (6.6 to 1) It has a Mini AC 1215 brushless motor. This combination mated with a 2100MAH Li-Poly 3 cell battery and a 12x6 slow fly prop, will give unlimited vertical.

## Cowl Mounting

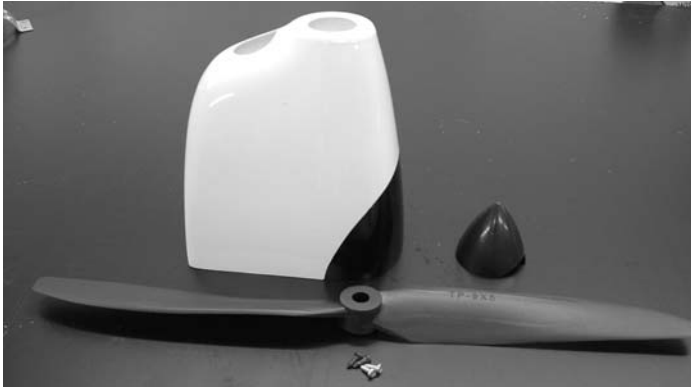

1.  Collect the following parts:
  - (1) Cowl
  - (1) Prop
  - (1) Spinner
  - (2) Plated mounting screws
  - (2) Black mounting screws

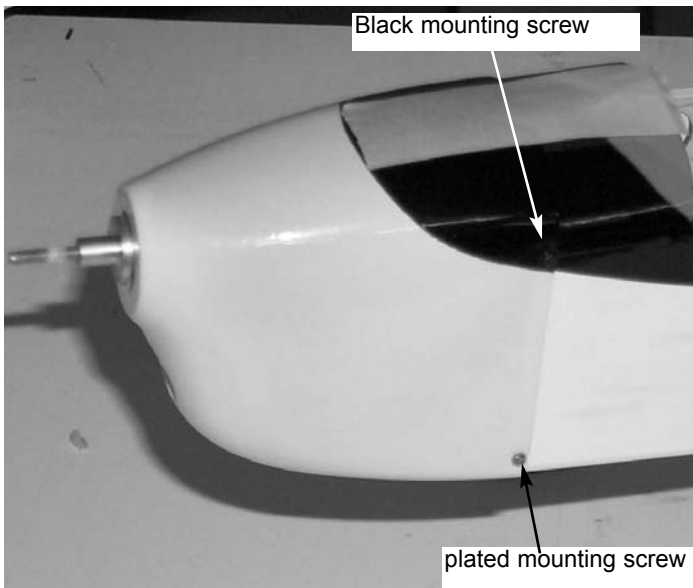

2.  Slide cowl in place, center the prop shaft in the nose ring hole.
  - Put the prop and spinner in place to make sure you are leaving enough clearance at the front of the cowl.
  - Tape the cowl in place making sure the trim line are lined up.
  - When everything is lined up properly, drill four mounting holes for the mounting screws.
  - The holes should be 1/32" with one in the lower corner on each side and one just above the black at the top on each side.

## Canopy Mounting



1.  Collect the following items:
  - (1) Black canopy
  - (1) Hatch

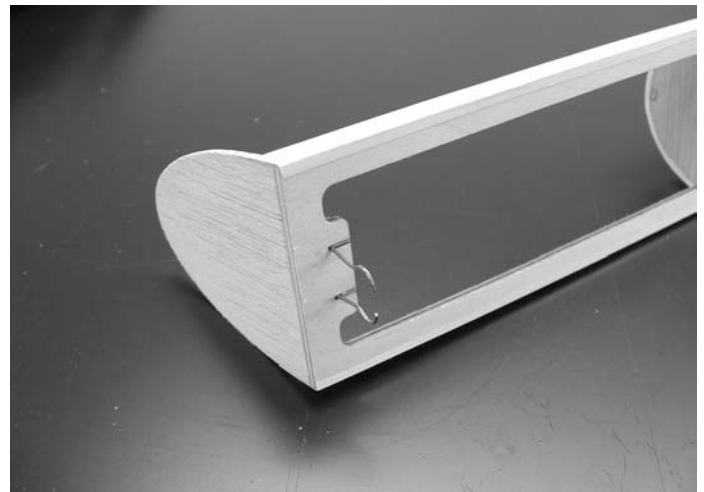

2.  The hatch is held on with a wire clip, already installed. Fit the hatch on the fuselage and make sure the latch is engaged.



3.  Apply a small bead of canopy glue around the edge of the canopy.

## CG and Control Throws

The CG should be 3-1/2" to 4" behind the leading edge at the fuselage. Our model balanced and flew with no added weight set up as shown.

**Notice:**

The plane is very responsive with a high rate of roll, so be ready for snap-py performance. Do not fly on high rates on your first flight.

**Elevator** Low Rate 1/2" each way  
High Rate All you can get

**Ailerons** Low Rate 3/8" each way  
High Rate All you can get

**Rudder** Low Rate 1" each way  
High Rate All you can get

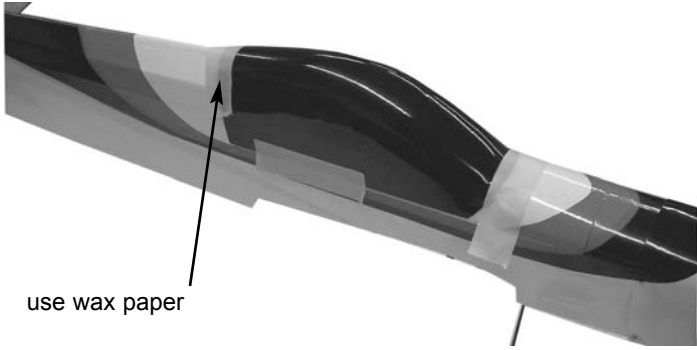

- 4.  Place the canopy on hatch and tape in place till dry. Use wax paper at the rear to make sure you don't glue the canopy to the turtle deck.

**Important:**  
Don't glue the canopy to the hatch without the hatch being installed on plane. If you glue it off the plane it might not fit when you try to install it.

## Receiver-Battery Installation

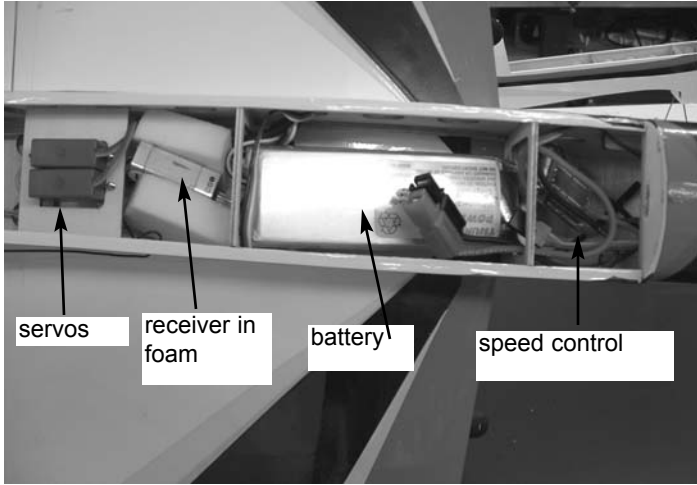

- 1.  The receiver can go just in front of the servos, the battery will fit just forward of the receiver and the speed control can go in the nose compartment.
  - Important: The battery must have some sort of retainer over the top, Don't depend on the canopy to hold it in place.
- 2.  The battery can be taped to the top of the wing using double sided tape, this is how we did it. You can also glue velcro( not included) to the top of the wing, or you can glue a small piece of wood over the top.