

Tiger 120 ARF



INSTRUCTIONS

Ideal as a first giant trainer and as a terrific everyday sport plane, the Tiger 120 ARF combines docile flight characteristics with the aptitude for super-smooth, exciting aerobatics. This ARF has been designed to keep building time to a minimum; it's 90% pre-built, with a pre-assembled elevator and installed pushrod and wing guide tubes, and it features top-quality American hardware and premium covering. So read through these instructions, follow them carefully, and you'll soon be flying a Tiger that "growls as you grow." The better you get the more fun it gives you!

WARNING

A radio-controlled model is not a toy and is not intended for persons under 16 years old. Keep this kit out of the reach of younger children, as it contains parts that could be dangerous. A radio-controlled model is capable of causing serious bodily injury and property damage. It is the buyer's responsibility to assemble this aircraft correctly and to properly install the motor, radio, and all other equipment. Test and fly the finished model only in the presence and with the assistance of another experienced R/C flyer. The model must always be operated and flown using great care and common sense, as well as in accordance with the Safety Code of the Academy of Model Aeronautics (5151 Memorial Drive, Muncie, IN 47302, 1-800-435-9262). We suggest you join the AMA and become properly insured prior to flying this model. Also, consult with the AMA or your local hobby dealer to find an experienced instructor in your area. Per the Federal Communications Commission, you are required to use only those radio frequencies specified "for Model Aircraft."

LIMITED WARRANTY

Carl Goldberg Products has inspected and certified the components of this aircraft. The company urges the buyer to perform his own inspection, prior to assembly, and to immediately request a replacement of any parts he believes to be defective for their intended use. The company warrants replacement of any such components, provided the buyer requests such replacement within a period of one year from the date of purchase and provided the defective part is returned, if so requested by the company.

No other warranty, expressed or implied, is made by the company with respect to this kit. The buyer acknowledges and understands that it is his responsibility to carefully assemble the finished flying model airplane and to fly it safely. The buyer hereby assumes full responsibility for the risk and all liability for personal or property damage or injury arising out of the buyer's use of the components of this kit.

P.O. Box 818 Oakwood GA 30566 Phone #678-450-0085 Fax # 770-532-2163 www.carlgoldbergproducts.com

© Copyright 2006 Carl Goldberg Products LTD.

ITEMS NEEDED TO COMPLETE THIS AIR-CRAFT

- 1 RADIO GUIDANCE SYSTEM (5 CHANNEL MINIMUM REQUIRED) 8 SERVOS
- 2 6" FLAP SERVO EXTENSION WIRES
- 2 18" AILERON SERVO EXTENSION WIRES
- 2 Y-HARNESS
- 1 ENGINE .90-.1.20 2-CYCLE or .90-1.80 4-cycle, AND MUFFLER
- 1 CA Accelerator
- 1 2 OZ. Bottle medium CA
- 1 1/2 OZ. Bottle Thin CA
- 1 30 minute and/or 5 minute epoxy.
- 1 Foam rubber 1/2"x8"x12"
- 1 3" Spinner

NOTE: The Tiger 120 ARF is covered in White (#870) UltraCote®. The trim colors are True Red #866, Yellow #872 and Orange #877.

TOOLS AND SUPPLIES FOR ASSEMBLY.

- MODELING OR UTILITY KNIFE
- WORK SURFACE (24" X70")
- ELECTRIC DRILL
- 1/16", 5/64", 3/32", 1/8", 5/32", 1/4" DRILL BITS
- SMALL STANDARD & PHILLIPS SCREW-DRIVERS
- MASKING TAPE
- NEEDLE NOSE PLIERS
- 36" RULER OR TAPE MEASURE
- FLEXIBLE STRAIGHT-EDGE
- T-SQUARE
- 30-60-90° x 6" TRIANGLE
- SOFT PENCIL
- A FEW STRAIGHT OR "T" PINS
- ADJUSTABLE WRENCH
- WIRE CUTTER
- OPTIONAL HEAT GUN/COVERING IRON
- ACID BRUSH

INTRODUCTION

USING THIS INSTRUCTION MANUAL

Before you begin assembling your **Tiger 120 ARF**, take some time to read through this entire instruction book. It is designed to take you step-by-step through the process and to give you added information on engine and radio selection and set-up, balancing your aircraft, and flying your model. The time you spend will speed the assembly process and help you avoid problems.

PREPARING FOR ASSEMBLY

You will need a work area of approximately 24 x 70" which has been covered to protect it from adhesive, as well as cuts and other damage. Many people cover their work area with a sheet of dry wall (sheet rock) and/or waxed paper to prevent CA and Epoxy from ruining the work surface.

CONSTRUCTION TIPS

IMPORTANT: ALWAYS READ A FEW STEPS AHEAD. This will alert you to coming instructions and will help you plan accordingly.

Using the Parts Identification section, familiarize yourself with the various items included in your kit box.

As you work, **CHECK OFF EACH STEP** in the box provided, so that you are sure you do not forget anything.

Do not hesitate to ask questions. Your local hobby dealer and area flyers will most likely be happy to help, as they want you to have a successful flying experience. You may also receive technical assistance from Carl Goldberg Products via e-mail (carlgoldbergproducts.com) or by telephone 678-450-0085.

COVERING

The Tiger 120 ARF is covered in premium iron on film. It is not uncommon for ARF's to develop a few wrinkles in transit. If this is true of your model, the situation is easily corrected. Before you begin putting the pieces together, run over the surface of each section with an iron (either specially designed for airplane use or the more cumbersome household iron) or use a modeling heat gun. Apply the heat (set at about 350° F), following along with a soft cloth and pressing down on the covering as you go around. This will more firmly set the covering adhesive into the wood and keep your aircraft covering tight and smooth in the future.

One of the great advantages of film is that it can be applied over itself without causing gas bubbles. This allows you to repair your aircraft, as well as to customize it in a number of ways. If, due to a flight mishap, you get a hole or similar covering damage, simply trim away the ragged edges and then apply a patch, following the directions that come with replacement film, which is available at your hobby dealer. In case of a major crash, where large amounts of the film must be replaced, heat the damaged covering and then slowly peel up. If you are applying sufficient heat, the film will come up easily and leave no color on the wood.

ADHESIVES & GLUING TECHNIQUES

CA adhesives are specially formulated to firmly glue the plywood, hardwood, and balsa used in your model and to withstand the vibration and stresses of high performance flight. However, there are times, such as when you are installing the stabilizer and fin on the fuselage and want more set-up time for careful alignment and positioning, then you should use epoxy. Occasionally, you also will want to use thin CA, which "wicks" into the surrounding areas. Aliphatic resin glue or similar water-based glues can also be used, but they will add to the assembly time because they dry so much more slowly than CA glue. Remember, when ever using any CA, you must be careful to read instructions thoroughly, as you will have only seconds for positioning of parts. Be sure to trial fit parts together before gluing. Also, never use watery THIN type CA glue for gluing plywood and hardwood parts. Thin CA's do not adequately bond these areas.

CAUTION

Some people may experience an allergic reaction when exposed to fumes from CA glue or epoxy. As with paints, thinners, and solvents, it is always important to use glues only where there is adequate ventilation to carry fumes away. A fan is recommended. Also, special care must be taken when using CA, as it will bond skin as well as other surfaces. Before using any CA, carefully read all label precautions. When using CA, protective eye-wear and care in keeping the glue away from the face is highly recommended. If CA does happen to get into the eye, hold lid open and flush with water only. Seek immediate medical attention.

RADIO EQUIPMENT & CARE

There are many fine radio systems on the market. Your local hobby dealer and club members are good sources of information on equipment and its suitability for various projects. It is recommended that you speak to them before making a final choice.

Today's RC systems are very well engineered and constructed.

However, they will remain only as good as the way in which they are USED. Always follow the rules of proper usage and all manufacturer's instructions for your particular piece of equipment.



TRANSMITTERS: Keep your transmitter clean and free from fuel residue and dirt. Battery condition and RF output should be monitored, and the system should be aligned and tuned annually. Do not transport under vibration (such as on the floor of a car) without cushioning.

RECEIVERS: Receivers must be vibration free. When installing in the aircraft, wrap them in a minimum of 1/4" soft foam rubber (not plastic foam). Keep well clear of all cables and batteries. Tune annually (or as recommended by the manufacturer), as indicated below under "Check-Ups."

SERVOS: Servos are vibration prone. Be sure to mount them with grommet shock mounts in servo trays which are also shock mounted. Also be sure to keep them clean. If the neutral position "drifts," this is a sign of change which should not be ignored; find out WHY before flying again.

BATTERIES: Nicads also can suffer from vibration, so they too should be wrapped in soft foam rubber before installing. Check their condition periodically by measuring the voltage with a volt meter or battery tester. Charge the batteries before EVERY flying session. When not used for a period of time (such as during the winter months) the batteries should be charged every 30 days. Never store batteries in a discharged condition.

PUSHRODS: Obviously, pushrods should be installed to operate freely, so that they place no load on the servo. Using a servo's power to move a tight rod or heavy surface by force increases the battery drain, shortens the electronic life, and can cause neutralizing problems. In addition, it is important the pushrods do not flex or vibrate. Any vibration is transferred directly to the servo.

CONNECTORS: In using connectors, never pull on the wires to disconnect; grasp the plugs instead. Clean them by dunking in a solvent, such as dope thinner. Tape the connectors together when installing and make sure there is no strain on the cables.

CHECK-UPS: A full check-up by the factory or an author-

ized service center should be done AT LEAST ONCE A YEAR, as well as any time something unusual occurs during usage. A malfunction or "glitch" is the first sign of an impending failure; it should not be ignored. The checkup should include tuning and alignment of the system, as well as battery testing.

ENGINE & PROPELLER SELECTION

When selecting an engine, it is important to stay within the manufacturer's recommended range, as failure to do so is likely to lead to less than satisfactory performance and may well lead to failure of the aircraft. Remember, that manufacturers design and test their models for specific engine sizes. Therefore, the aircraft is unlikely to withstand the stresses created above this range. Many a modeler has watched all his hours of work and many dollars worth of hardware head earthward because he did not heed this warning: **DO NOT OVER-POWER YOUR MODEL!** Doing so will automatically void the manufacturer's warranty.

Typically, size recommendations are for both a 2-cycle or a 4-cycle engine. A 2-cycle engine has more raw power because it has faster RPMs on the propeller. A 4-cycle engine swings a bigger prop and therefore creates more pull. It is also quieter. 4-cycle engines are generally preferred for high performance, more aerobatic planes. However, if flying a tri-gear plane, a 2-cycle should be used. The expense of an engine is usually related to its efficiency. Some engines of similar cubic inch displacements are more powerful than others. Check with a dealer or an experienced flyer to learn about the specific attributes of the engine you are considering.

If selecting a more sophisticated engine, you may go with the lower recommended range. However, if purchasing a more basic engine, it is probably best to select something in the higher recommended range. If you are a relatively new RC pilot, it's probably a good idea to select an engine that is popular at the flying field, so that if you have any engine problems, other modelers will be familiar with the engine and be able to help. **REMEMBER: DON'T OVER-POWER THE AIRCRAFT!**

The propeller size must be matched to the engine. For example, a .60 may use a 11" diameter prop while a .80 can use a 13" prop. Refer to the information that is sup-

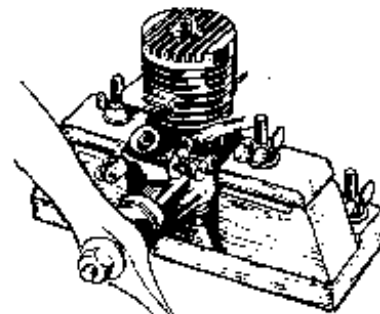

plied with your engine for recommended propeller sizes. It's wise to buy a few spare props, as everyone breaks them occasionally, and particularly often when learning to fly.

Balancing your propeller helps to protect your radio from the damaging effects of vibration. There are good, easy to use prop balancers on the market. Follow the instructions that are supplied with the prop balancer. Never

carve or cut a prop near the hub for any reason (such as to fit a spinner).

A 3" CGP 4-Pin Snap-On Spinner is available for the Tiger 120 ARF. It is a rugged precision molded spinner that does not require any special mounting nuts or screws. Carefully read the spinner instructions and warnings included in this book. Although a spinner helps reduce the chance of injury from a rotating prop, extreme caution always must be used when the engine is running.

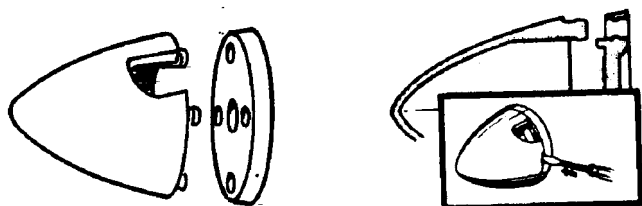

As with other precision equipment, a new engine should be "broken-in" to enhance performance and extend its life. Breaking-in usually consists of running the engine with a "rich" fuel mixture and at lower RPMs until all the moving parts get to "know each other better." This can be done with the engine mounted in the model or securely clamped into a CGP Engine Test Stand or similar device. Refer to your engine's operating manual for the recommended break-in procedure and follow it carefully.

CGP ENGINE TEST STAND

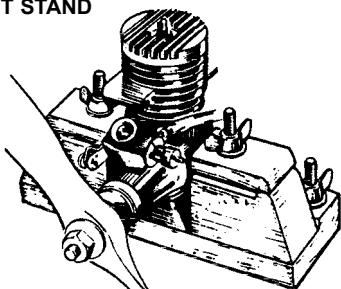

FIELD EQUIPMENT

The following equipment will be needed at the flying field to start your engine, make adjustments, and clean your model after flying.

FLIGHT BOX: Something sturdy in which to carry your equipment. CGP's quick-building MiniTote carries the basics: fuel, starter and battery, and a few essential tools. The larger CGP Super Tote is economical, easy to build, and pack lots of utility into little space. They hold fuel, transmitter, starter & battery, as well as many tools, in a balanced load that is easy to carry. The fuel tote is designed to carry your fuel in a handy box that keeps the jugs from rolling around in your car.



STARTING BATTERY AND GLO-PLUG CLIP: A 1-1/2 volt battery is required to heat your engine's glo-plug for starting. Wires connect the glo-plug clip to the battery. Because engine starting draws a lot of electric power from the battery, rechargeable ni-cad batteries are recommended. Although they cost more initially, they are more economical in the long run than frequently replacing dry-cell batteries.

FUEL: For best engine performance, use the fuel recommended by your engine's manufacturer. 2 and 4-cycle engines require different fuel blends. Ask your dealer to recommend a good quality fuel.

FUEL PUMP: Needed to transfer fuel from the fuel can to the model's fuel tank. A simple squeeze-type bulb will do for small tanks, whereas manual crank or electric pumps fill larger tanks more quickly.

FUEL LINE: Have about 3 feet of silicone fuel line to make connections between the fuel pump, the fuel can, and the model's fuel tank.

EXTRA PROPS: Experts always have a few spares on hand, so flying doesn't have to stop due to a broken propeller.

GLOSSARY OF MODELING TERMS

ARF: Almost Ready to Fly
AILERON: the control surface on the wing that rolls the plane
AIRFOIL: the shape of the wing as seen from the end
ANGLE OF ATTACK: the angle at which the wing meets the air flow
BEVEL: to sand to an angle shape
BURR: the rough edges on a piece of wood or metal after it is cut
CAP STRIP: a thin strip glued to the edges of the ribs to shape the wing
CONTROL HORN: a device attached to each control surface to provide an attachment point for the pushrod
COWL (COWLING): the nose section of the fuselage that encloses the engine
DECALAGE: the difference between the incidence of the wing and stabilizer
DIHEDRAL: the upward angle of the wings, as seen from the front
ELEVATOR: the moveable part of the horizontal tail, which controls pitch
EMPENNAGE: the tail of the plan
FIN: the fixed vertical part of the tail
FIREWALL: the hard wooden former at the front of the fuselage, to which the engine is mounted
FORMER: a piece which shapes the fuselage; and to which the sides of the fuselage are attached.
GUSSET: a small triangular piece glued into a corner to strengthen it
INCIDENCE: the angle of the wing or the tail in relation to the thrustline
LAMINATE: to glue two thin sheets of material together to form a thick sheet
LEADING EDGE (L.E.): the edge of the wing that first meets the airflow
LONGERON: a stringer that runs the length of the fuselage
OUTPUT ARM: the piece that attaches to the servo and connects it to the pushrod
PITCH: an up and down movement of the nose of the plane, which is controlled by the elevator
PROTOTYPE: the full scale airplane from which the model design was taken
PUSHROD: the long, stiff dowel, plastic or wire piece that connects the servo with the control horn

RTF: Ready to Fly
RIB: the airfoil-shaped piece that connects the leading edge, spars and trailing edge of the wing together and holds them in shape
RETRACTS: devices for extending and retracting the wheels on command
ROLL: tilting of the plane as viewed from the front, controlled by the ailerons
RUDDER: the moveable vertical tail of the plane, which controls yaw
SERVO: the part of the airborne radio system that moves the control surfaces
SHEAR WEB: wood sheeting that connects the top and bottom spars to stiffen the wing
SHIM: a thin piece of wood inserted between two other pieces to improve their fit
SPAR: a wooden stick running lengthwise through the wing that serves as its backbone
SPINNER: the rounded cone that fits over the propeller hub
STABILIZER (STAB): the fixed horizontal part of the tail
STALL: a situation in which the plane is flying too slowly to move sufficient air across the wing to produce lift
STRINGER: a long piece of wood attached to the formers to shape the fuselage
THRUSTLINE: a line drawn from the center of the propeller hub straight through the airplane
TORQUE: a rolling tendency caused by the spinning propeller
TRAILING EDGE (T.E.): the edge of the wing that faces the rear of the plane
TRIM: small adjustments made to the control surfaces to cause the plane to fly straight and level by itself
WASHIN: a twist in the wing that makes the trailing edge lower than normal
WASHOUT: a twist in the wing that makes the trailing edge higher than normal
WING SADDLE: the shaped part of the fuselage in which the wing rests
WHEEL COLLAR: a metal ring that holds the wheel on the axle
YAW: a right-to-left movement of the nose, controlled by the rudder

HARDWARE IDENTIFICATION



BLIND NUT



EYELET



SNAP LINK

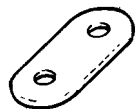

LANDING GEAR STRAP

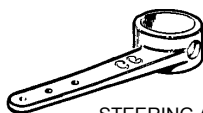

STEERING ARM

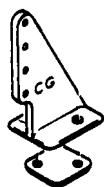

CONTROL HORN



PUSHROD CONNECTOR WITH SNAP NUT.

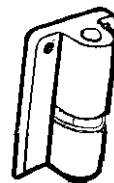

NOSE GEAR BLOCK



WASHER



SET SCREW



SOCKET HEAD SCREW



WHEEL COLLAR



PAN HEAD SCREW



SHEET METAL SCREW

WING ASSEMBLY & INSTALLATION

AILERON and Flap INSTALLATION



1. Collect the following parts:

- (1) Left and right wing
- (1) Left and right aileron
- (1) Left and right flap
- (14) CA hinge



2. Locate the pre-cut aileron and flap hinge slots in both wing halves. Using a hobby knife (#11 blade), slide the blade into each slot to make sure it is cleanly cut.
- Repeat this process with the ailerons and flaps, making sure all hinge slots are clean.

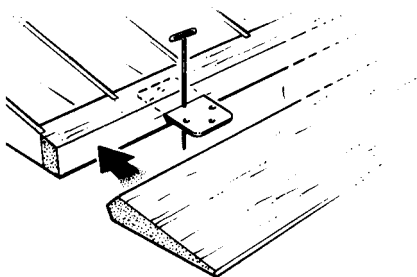

3. Place a straight pin into the center of each of the four CA hinges.
- Slide each hinge into the hinge slots on one of the wing halves. The pin will prevent the hinges from going in further than halfway into the wing.
4. Select the aileron for the wing on which you are working and insert the exposed half of each hinge into the aileron slots.

- Slide the aileron toward the wing until no gap remains between the aileron and the wing.
- Install the flap in the same manner. Align the stripes on the wing and make sure the aileron clears the tip and the flap.
5. When satisfied with the alignment, remove the straight pins, being sure to keep the aileron and flap tight to the wing. You may wish to apply a few pieces of masking tape to keep the pieces in place.



6. Keeping the aileron, flap, and wing in position, apply 3 or 4 drops of thin CA to the small exposed area of each hinge.
- Turn the assembly over and again apply 3 or 4 drops of CA to the exposed hinge surfaces.
- Allow to dry for 10 minutes before flexing the aileron.
7. Repeat the above steps for the other half of the wing and each flap.

AILERON SERVO INSTALLATION

The following pictures may not exactly match the hardware you are using. Always check the radio manufacturer's instructions when installing radio equipment.



1. Collect the following items:
- (2) Wing halves
 - (4) Servos with rubber grommets
 - (16) Servo Mounting Screw (supplied with radio)
 - (2) 18" servo extensions
 - (2) 6" servo extensions



2. Pull the servo leads down through the wing and exit through the hole on the top surface of the wing.

IMPORTANT! To ensure that any connections located inside the wing will not come loose, either when the wires are pulled, and during flying, always tape them securely together with electrical tape.

3. Repeat these steps for the other half of the wing, so that both servo extensions are exiting the holes in the center of the wing.



4. Mount the aileron and flap servos using the hardware supplied with the radio. The output arm should go toward the leading edge.

AILERON FLAP CONTROL HORN INSTALLATION

1. Collect the following items
 - (4) Silicone clevis keepers
 - (4) 4-40 x 1-3/4" bolts
 - (4) 4-40 metal clevis
 - (4) 4-40 nuts
 - (4) Nylon ball nuts
 - (4) Nylon washers
 - (4) Nylon control clevis
 - (4) 4-40 x 5-1/2" pushrods threaded both ends

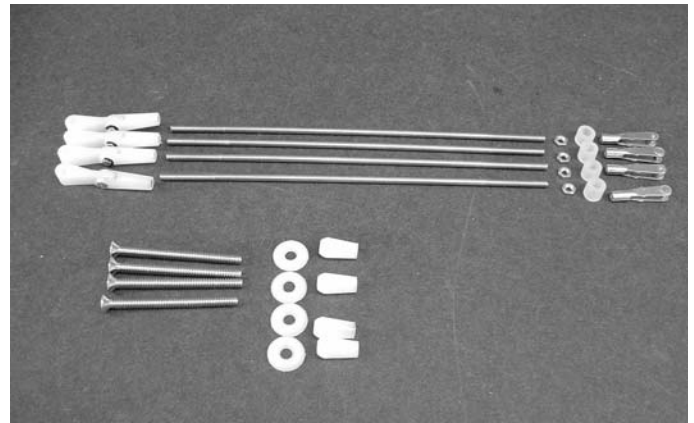

2. Use a straight edge and make a mark at a 90° degree angle to the trailing edge and in line with the side of the servo



3. For proper operation the aileron servo horn location should be marked on the outboard side of each servo (closest to tip). The flaps will need to be marked on the outboard side on one wing and the inboard side on the other wing.

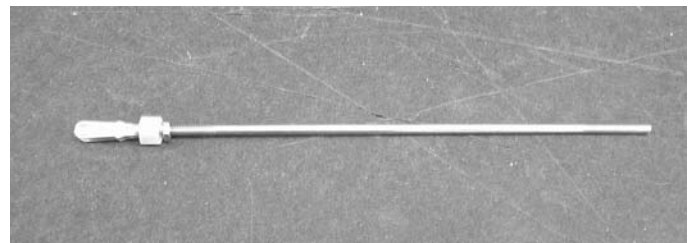
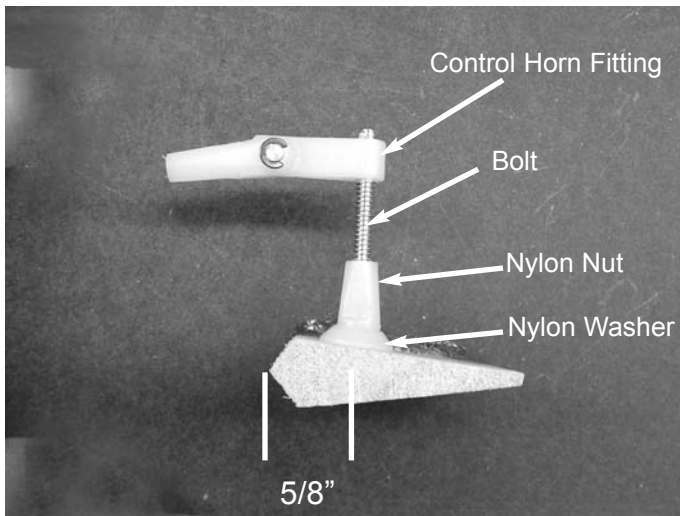

- 6. Locate the 4-40 pushrods and thread a nut and a clevis with silicone keeper on one end. The aileron pushrods are 1 1/4" longer than the flap pushrods.

- 4. Measure 5/8" back from the trailing edge of the wing along the mark you made for the control horn. Drill a 9/64" hole at this location. Make the hole perpendicular to the trailing edge of the wing, not square to the surface of the aileron.
- 5. Insert the 6-32 bolt through the ailerons from the top side. No washer goes on the top. Place the nylon washer on the bottom side and screw the nylon nut in place. The nut will self tap onto the screw but it is much easier if you run a 6-32 tap through the hole first. Run the tap through the control horn fitting also and screw into place. Leave it flush with the top of the screw or one thread down (1/32") to provide the mechanical leverage needed.

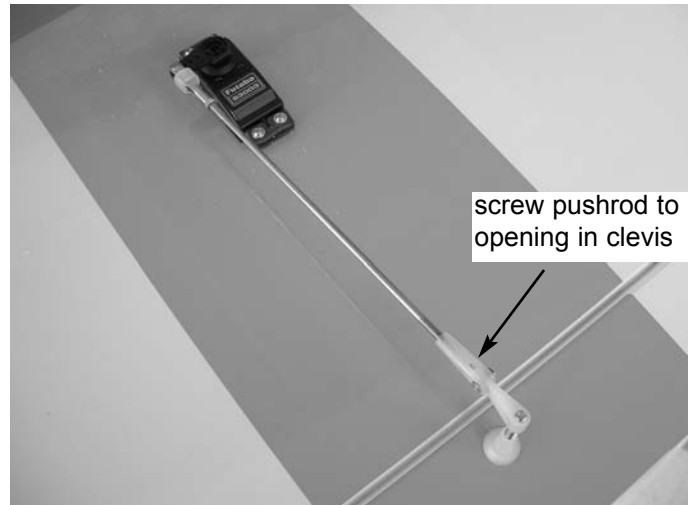

- 7. Screw the other end of the pushrod into the nylon pushrod fitting. It should screw in to the opening in the back of the clevis. Center the aileron and servo and attach the clevis to the output arm on your servo. Adjust the clevis to fit.

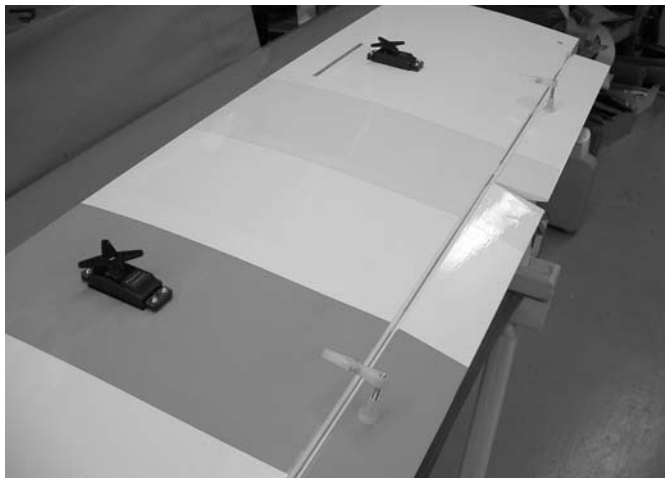

- 6. Repeat for the other aileron and both flaps.

WING INSTALLATION ON FUSELAGE

1. Collect the following items:
 - (1) Right wing
 - (1) Left wing
 - (2) 8mm x 36mm aluminum dowel
 - (1) Large aluminum tube
 - (1) Small aluminum Tube
 - (2) 1/4-20 x 2" nylon bolts
 - (2) Plywood reinforcement plate

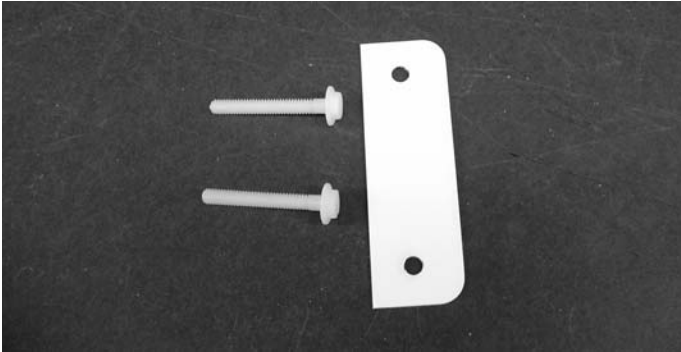

NOTE: If the covering on your wing has loosened in transit, refer to the covering section of the "INTRODUCTION" before continuing.

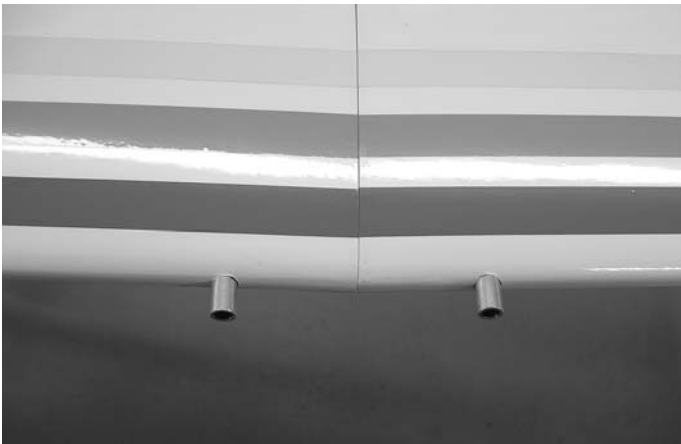

2. Using epoxy, mount the 8mm x 36mm aluminum dowels into the holes in the leading edge of the wing. Make sure to leave about 1/2" of dowel sticking out of the front of the wing. You may wish to slightly taper the exposed dowel ends for ease of insertion into the fuse holes.



3. Insert the large aluminum tube into one wing half and push the tube into the wing until it stops. Then insert the small aluminum tube into the small hole till it stops. Then slide the wing halves together.



4. Insert the wing into the wing saddle of the fuselage by sliding the dowels in the front of the wing into the holes in the former just forward of the wing saddle.



- Align the holes in the wing bolt plate over the holes in the wing. Insert the 1/4x20 bolts and tighten.

TAIL ASSEMBLY & INSTALLATION

STAB & ELEVATOR INSTALLATION

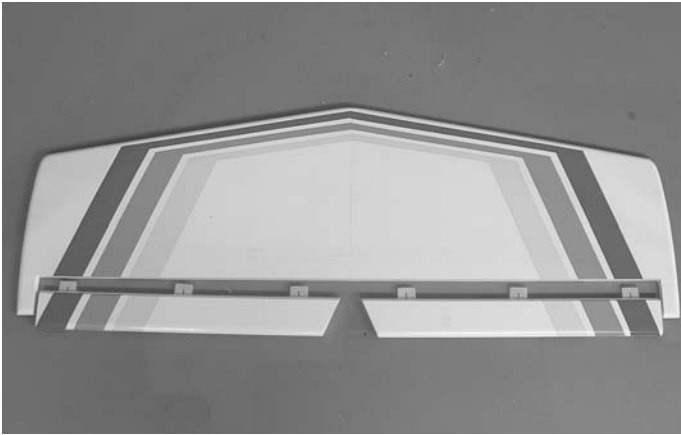

1. Collect the following parts:
 - (1) Stabilizer
 - (2) Elevators
 - (1) Wing/fuse assembly
 - (6) CA hinges

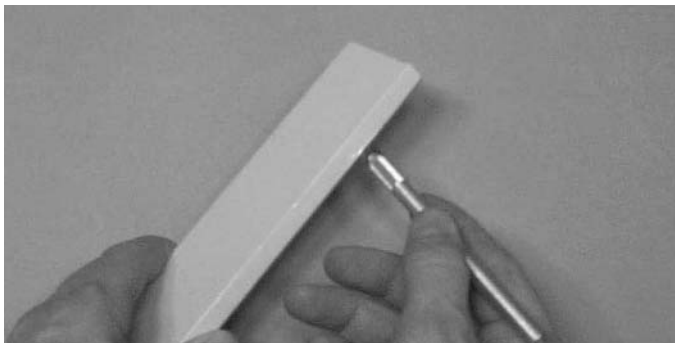

2. As with the wing and ailerons, use a modeling knife to make sure the hinge slots are cleanly cut.

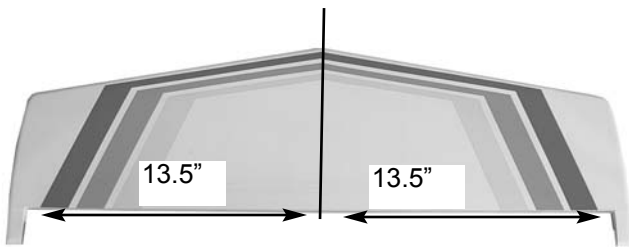

3. Place two strips of masking tape along the edge of the stab, next to the outer stab tips and above the hinge line.
 - Using a T-square, draw a line from the front center point of the stab to the rear hinge line.
 - Measure 13.5" out ("B") from the centerline and make a mark on the masking tape.

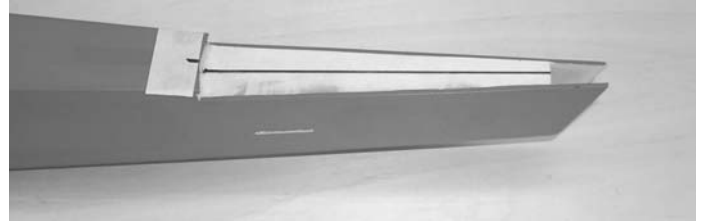

4. Place masking tape on the tip of the fuse, just in front of the stab.
5. Measure and mark the center point on the tape.

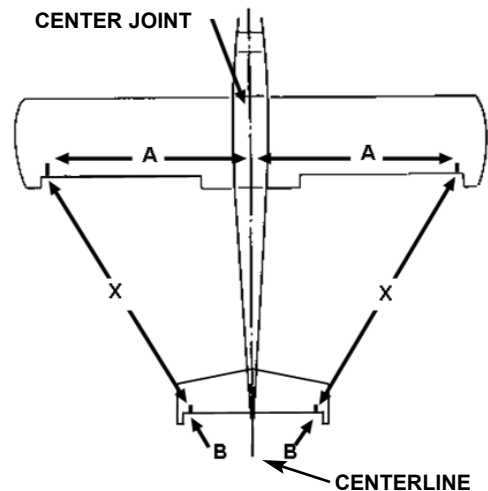

6. Place a piece of masking tape on each wing tip, just above the aileron hinge line.
 - Measure 35" out from the fuselage side to the wing tip and mark the spot on the tape, on both the left and the right side of the wing

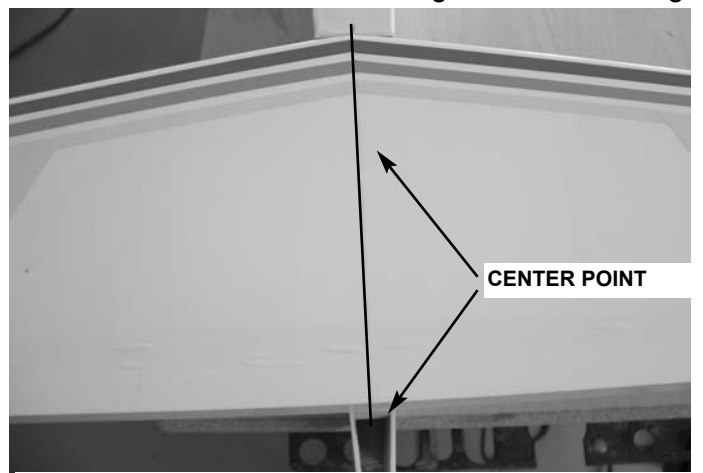

7. Place the stab on the platform with the center of the stab lined up with the center point on the fuse.
 - Measuring from the mark on each wing tip to the mark on the stab tip, make sure the distance "X" on the right side and left side of the plane are equal.

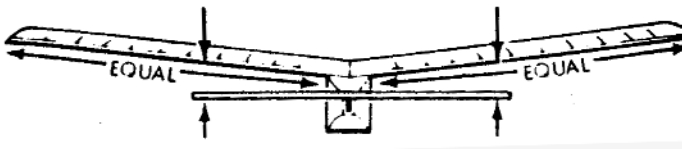

8. Make sure the stab is level (parallel) with the wing and insert paper strip shims, if necessary.



9. When satisfied with the alignment of the stab, temporarily tape securely in place.
- Turn over the plane and mark the area on the bottom of the stab where it rests on the fuse.
 - Remove the stab from the fuse and, working 1/4" inside the drawn lines, carefully remove the covering from the bottom of the stab. BE CAREFUL TO AVOID CUTTING THE WOOD
10. Spread epoxy on both the bottom of the stab and the stab platform of the fuse.
- Replace the stab on the platform and, after again checking the alignment of the stab to the wing, allow the epoxy to dry thoroughly.



11. As with the installation of the ailerons, insert a straight pin in the center of each CA hinge.
- Slide the hinges halfway into the elevator and then slide the entire assembly into the hinge slots in the stabilizer.

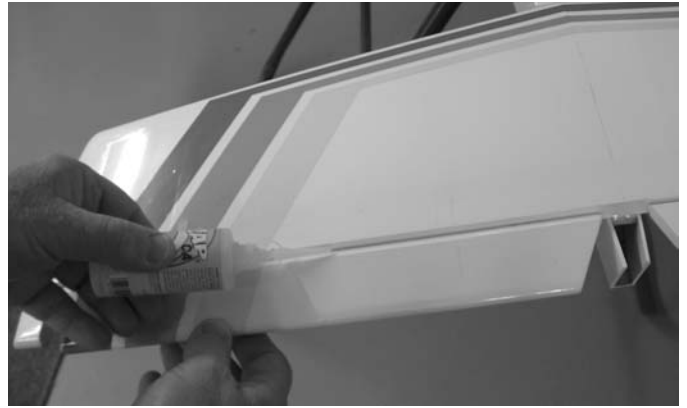

12. Keeping the stab and elevator in position, remove the pins and apply 3 or 4 drops of thin CA to each hinge location.
- Allow the elevator/stab assembly to dry for at least 10 minutes before flexing the elevator.

FIN INSTALLATION

1. Collect the following items:
- (1) Fin

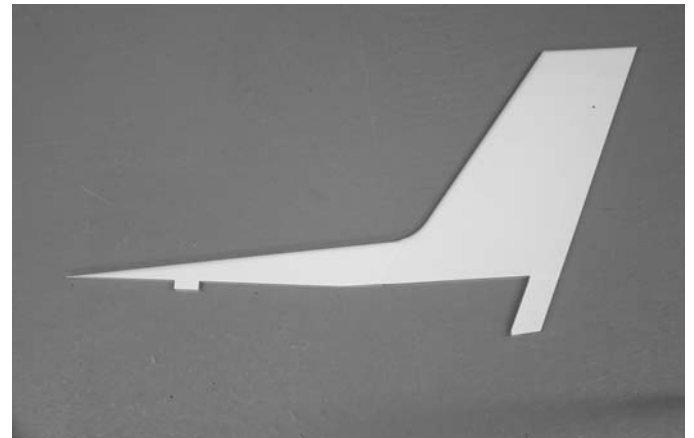

2. Trial fit the fit into the fuselage slot on the rear of the fuselage and the notch on top.



3. When satisfied with the fit, draw lines on the fuse and stab, on both sides of the fin, showing its location.

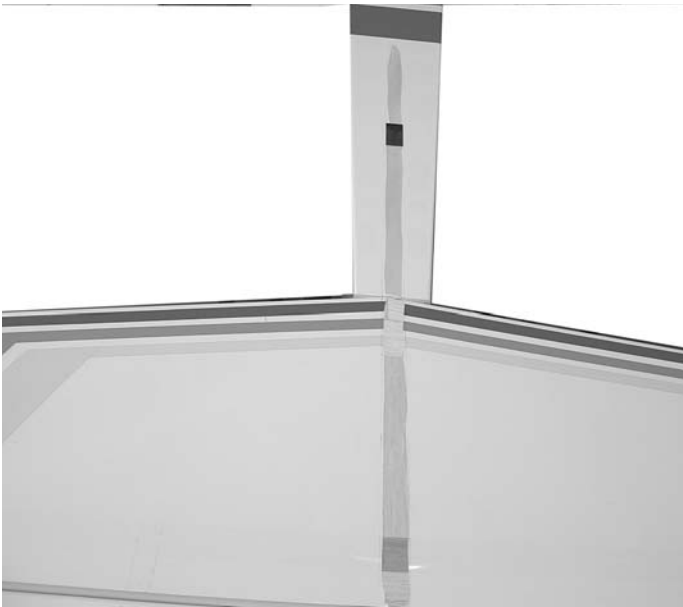

- TAKING CARE NOT TO CUT INTO THE WOOD STRUCTURE UNDERNEATH**, and working inside the drawn lines, carefully remove the covering where the fin mounts on the fuse and stab.

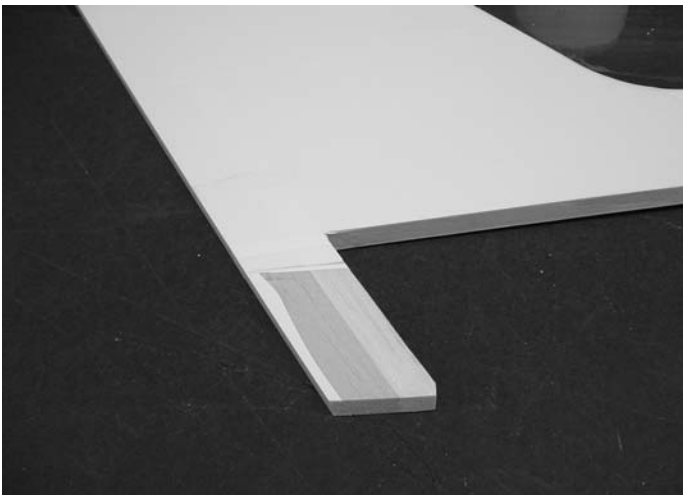

- 4. Also remove the covering on the bottom portion of the fin where it fits into the fuselage.

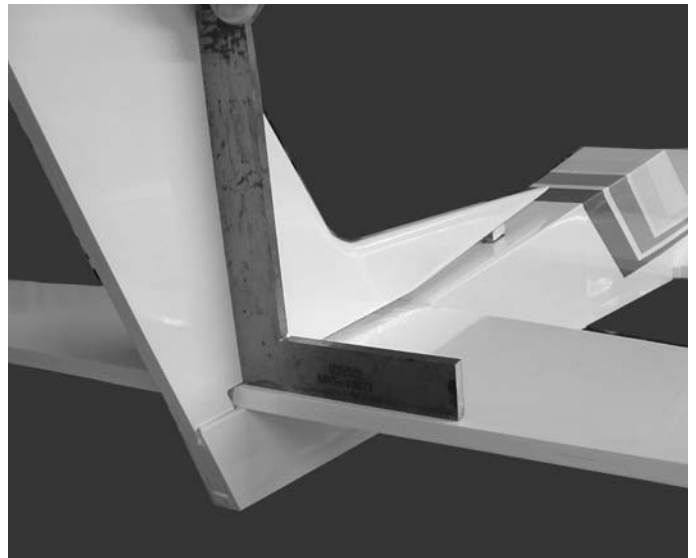

- 5. Remount the fin on the fuse and, using a 90° triangle, make sure the fin is perpendicular to the stab.
- When satisfied with the fit, remove fin and mix up a couple of spoonfuls of epoxy.
- Apply a **THIN**, even coat of epoxy on the bottom of the fin and along both sides of the fin mounting posts. Avoid too much glue, which will squeeze out from underneath the fin.
- Mount the fin on the fuse and place the triangle against the fin to make sure it is perpendicular.
- Use masking tape to secure the fin and triangle in position until the epoxy is thoroughly dry. Make sure not to glue the triangle!

RUDDER & ELEVATOR CONTROL HORN INSTALLATION

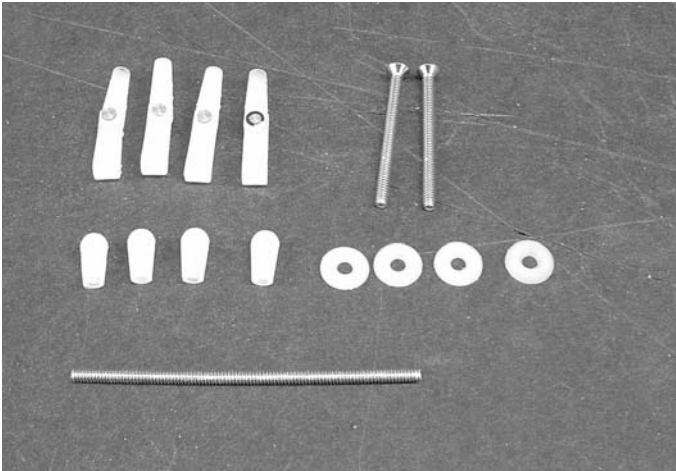

1. Collect the following items:

- (1) Rudder
- (1) fuselage with Elevators
- (3) CA hinges
- (2) 6-32 Control horn bolts
- (4) nylon control horn fittings
- (4) nylon washers
- (4) nylon nuts
- (1) 6-32 x 2-3/4" threaded rod

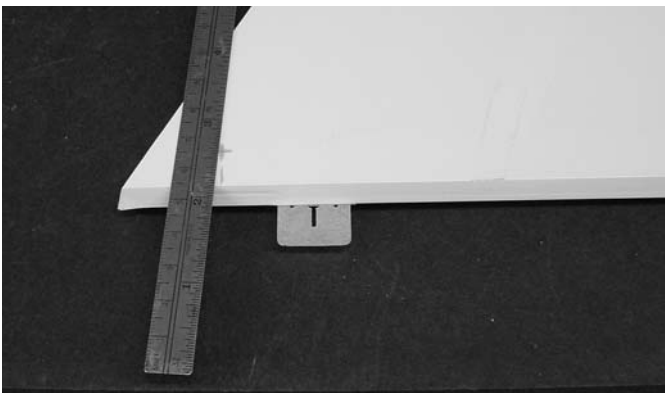

2. Measuring from the bottom of the fin along the leading edge 1-1/8" up from the bottom. Measure carefully because if you get it too high on the rudder it will interfere with the elevator control horns. It should be lined up with the exit holes in the side of the fuselage. Measure back from the leading edge 5/8" on this mark and drill a 9/64" hole.
- Install the 3-1/2" threaded rod through the hole.

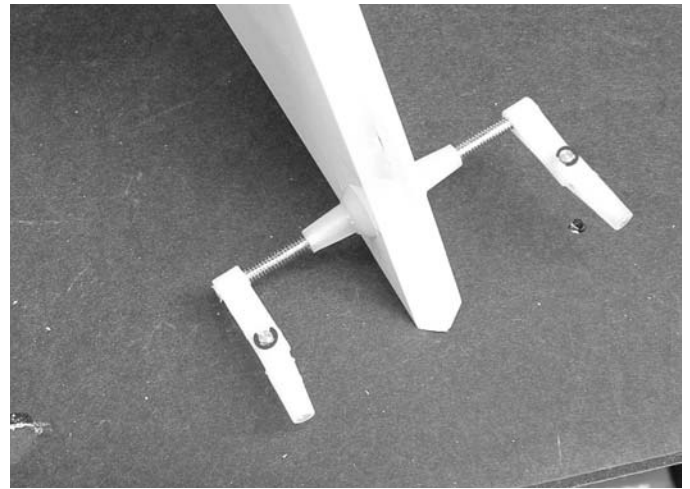

3. Install a nylon flat washer on each side and screw the nylon nuts in place on each side. Center the threaded rod in the rudder.
- Screw the nylon pushrod fittings on each end of the threaded rod flush with the end.



4. Using the three CA hinges, mount the rudder to the fin, just as was done for the elevator and the ailerons.

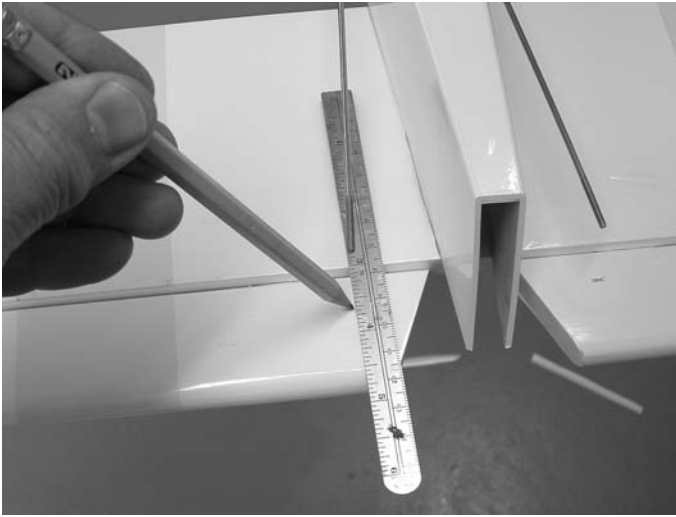

5. Insert the elevator pushrods into the tubes in the fuselage. Make a mark at the location they cross the elevator. This should be 1-1/4" out from the inside edge of the elevator. Make sure not to get them too close to the fuselage or they will interfere with the rudder horns. Measure back along this line 5/8" and drill a 9/64" hole for the control horn.



6. Install the 6-32 bolt from the top (no washer on top). Place the nylon washer on the bottom and screw the nylon nut into place. Thread the control horn on the end flush with the end of the bolt. Screw the elevator pushrods into the control horn fittings.

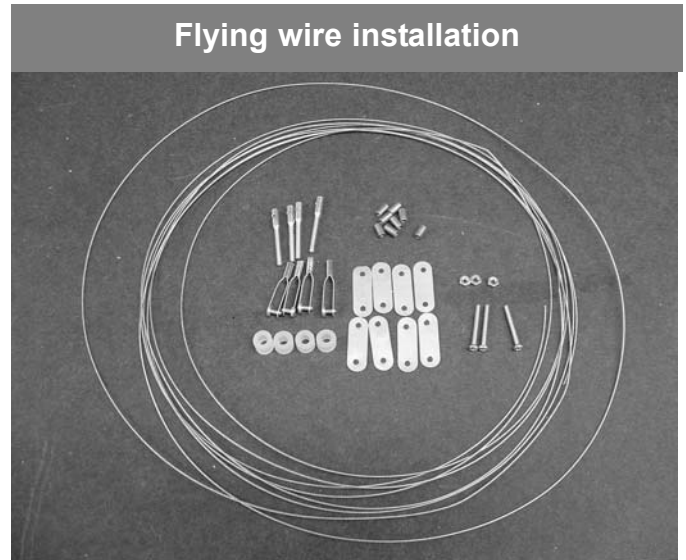

Flying wire installation

1. Collect the following items:

- (1) Braided cable
- (4) 2-56 rigging couplers
- (4) 2-56 clevis
- (4) Silicone clevis keepers
- (8) cable swages
- (8) metal cable brackets
- (3) 2mm x 13mm bolts
- (3) 2mm nuts

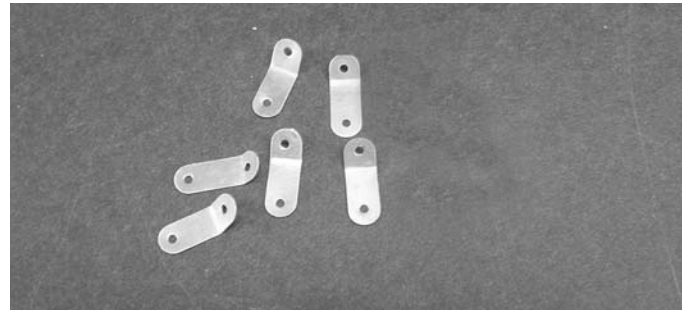

2. Take 6 of the metal brackets and grip 1/4" of the end with a pair of pliers and make a 45 degree bend .

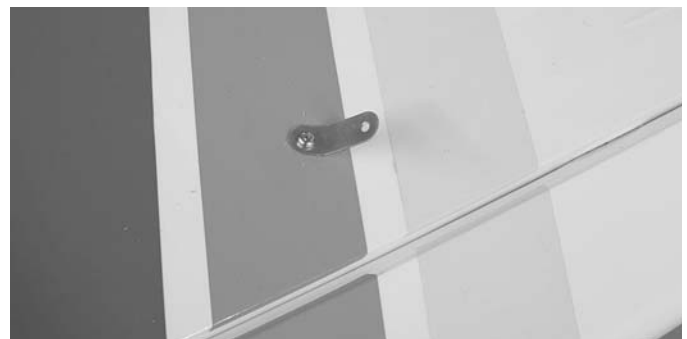

3. Using the 2mm screws and nuts, bolt the brackets in place on the stab and fin. The screw should go through the bracket, through the hole in the stab, then on the other side of the stab install another bracket and hold in place with the nut. Repeat for the fin, one bracket on each side.



Note: If you plan to do the tail dragger conversion you should skip ahead to the tail wheel mounting now. Then come back to step # 5 below.

4. Take the remaining two brackets and grip in the center with the pliers and make a 30 degree bend. Measure 1-1/2" from the rear of the fuselage and screw the two brackets in place using the #4 sheet metal screws. You will need to enlarge the hole on one end for the #4 screw.

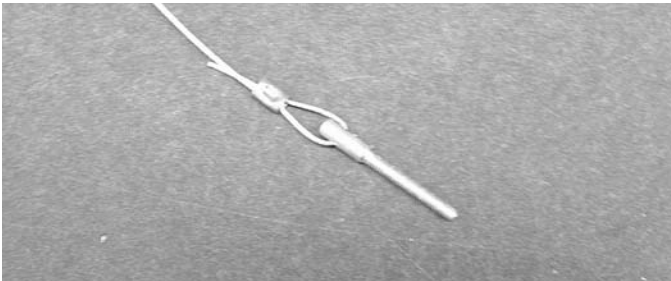

5. Take the braided cable and cut two 14-1/2" pieces and two 11" pieces for the flying wires. The remainder is the rudder cables. Slip the cable through the swage then through the hole in the rigging coupler. Let 1" extend through the hole then bend back through the swage. Crimp the swage to lock the cable in place.
- Repeat this for one end of each of the four cables.

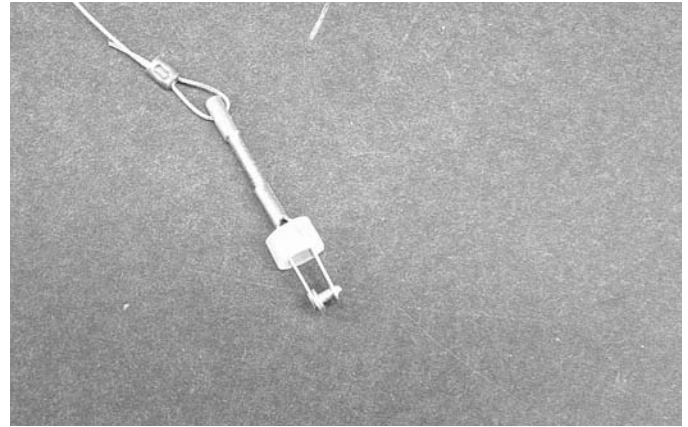

6. Put the silicone keeper on the clevis and screw the clevis onto the rigging coupler. Screw in into the clevis until the coupler is flush with the opening in the center of the clevis.
- Repeat for the other three cables.

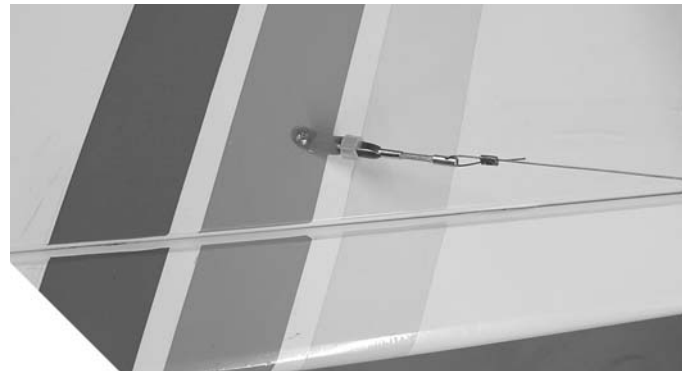

7. Attach the clevis of the two 14-1/2" cables onto the brackets on the top side of the stab.
- Attach the clevis of the two 11" cables onto the brackets on the bottom side of the stab.
- Screw a #4 nut onto the other four rigging couplers and screw the couplers into the clevis. Attach the clevis to the other four brackets.

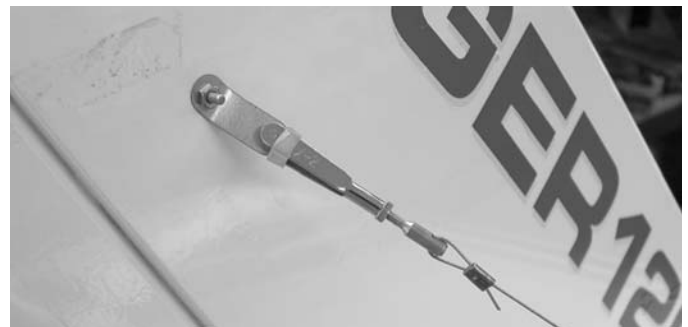

8. Pull the top cable through the swage, then through the coupler on the fin. Loop back through the swage and pull snug, don't get it too tight till the others are in place or you might warp the stab or fin. Crimp the swage.

- Repeat for the other top cable.



9. Take the bottom wires and fit through the bottom fuselage couplers and crimp in place. (Set-up shown is for tail wheel)



10. After all wires are in place adjust the tension using the clevises. Adjust equally so as not to warp the surfaces. They don't need to be guitar string tight, just snug.

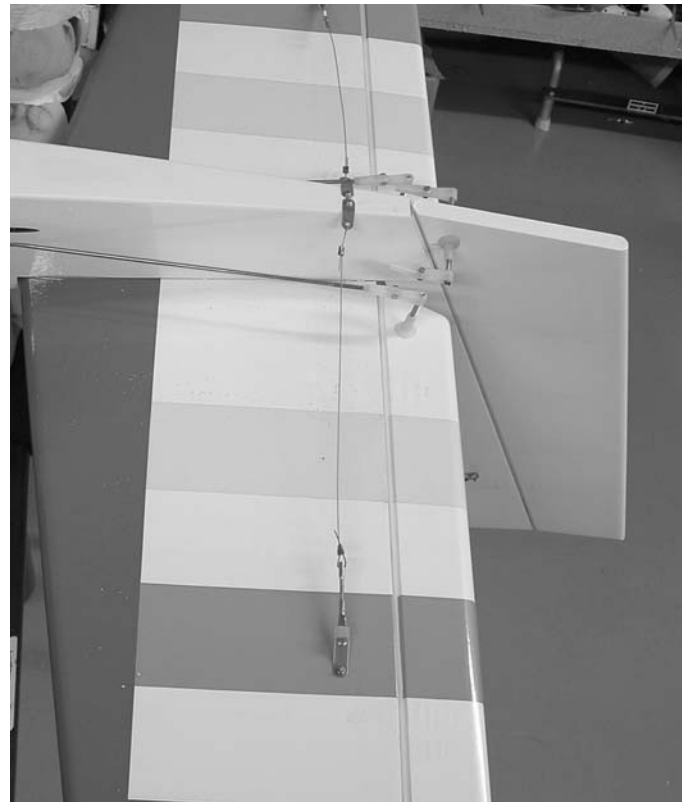

OUTFITTING THE FUSELAGE

FUEL TANK ASSEMBLY

1. Gather the following items
 - (1) fuel tank
 - (1) rubber tank stopper
 - (1) clunk
 - (1) 3mm x 25mm screw
 - (1) cap washer large
 - (1) cap washer small
 - (1) 3mm x 40mm brass tube
 - (1) 3mm x 60mm brass tube
 - (1) silicone tube 4mm x 80mm

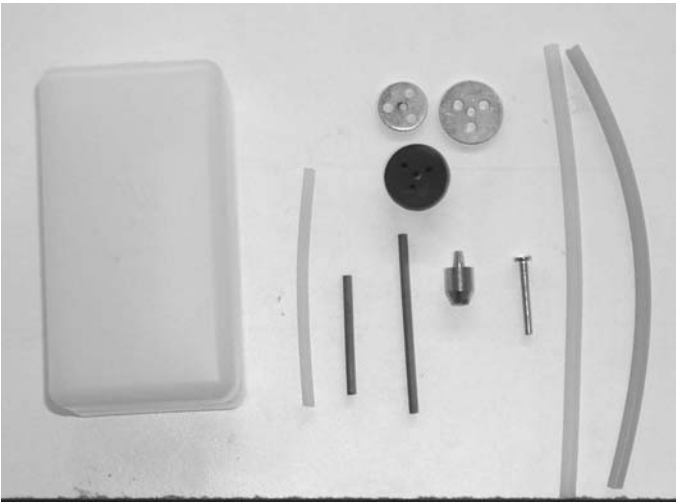

2. Insert the 3mm screw through the center hole in the large washer, through the center hole in the rubber washer against the large side, and screw the small washer on the back side.



- Decide if you want to use a two line or a three line tank. Most two strokes use a two line, one to the carb and a vent tube to the pressure fitting on the muffler. You can get to the carb line to remove and fill through.

On most four strokes you cannot get to the carb easily so plumb a third line into the tank to use as a fill line. You will fill through it then plug it for flight. The carb line will stay connected all the time.

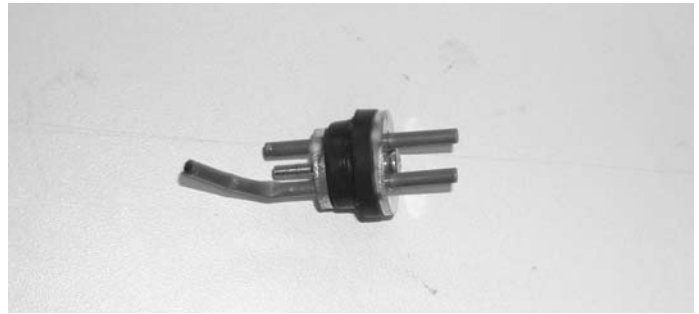

3. Insert the brass tubes through two or three of the holes. They should be arranged so as the long one (vent tube) will be on the right side of the plane and the short one on the left side.
 - The tubes should extend out the front of the cap 5/8". Bend the long tube up at about a 20 degree angle. This should be adjusted so the end of the tube almost touches the top of the tank when installed.

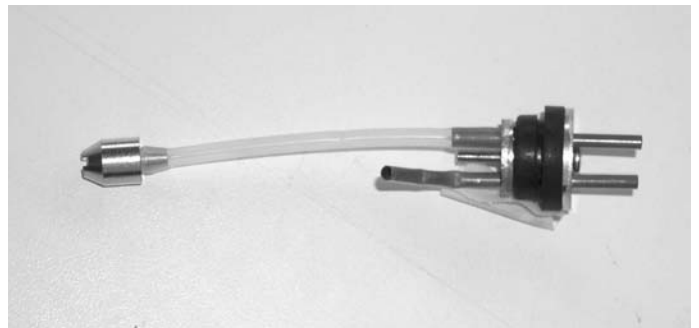

4. Install the 4mm silicone tube to the short brass tube and install the clunk to the other end of the silicone tube. This is the fuel pick-up and must be free to "flop" around in the tank so it can pick up fuel in any attitude.



5. Install the assembly into the tank so the vent tube is turned up to the top of the tank and is positioned on the right side of the tank. Tighten the screw to expand the rubber cap. Don't over tighten or you could split the tank.

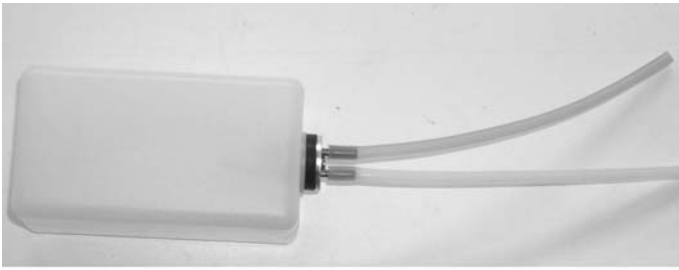

6. Attach the two pieces of 5mm tubing to the two tank outlets. Use different colors so you can tell which is the vent and which is the fuel pickup after the tank is installed. Make a note of which color you attach to which tube. The short brass with the clunk is the fuel pickup and must go to the carburetor. The long brass tube is the vent and should go to the pressure outlet on the muffler.
- Set tank aside till ready to install.

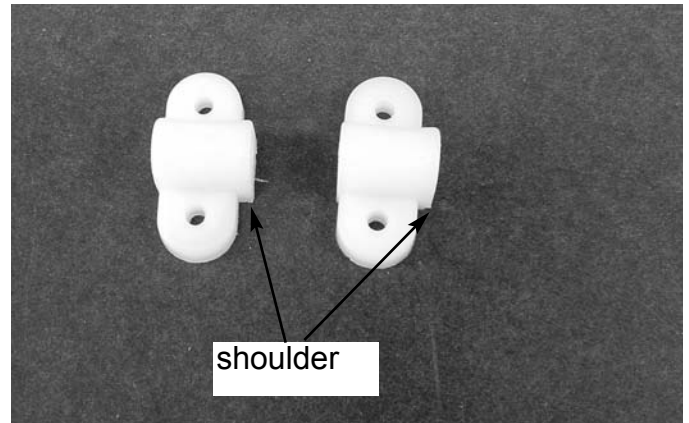

2. Cut the two tabs holding the nose gear blocks together. The blocks have a shoulder on one side. The shoulder should go toward the top on both pieces.

NOSE GEAR INSTALLATION

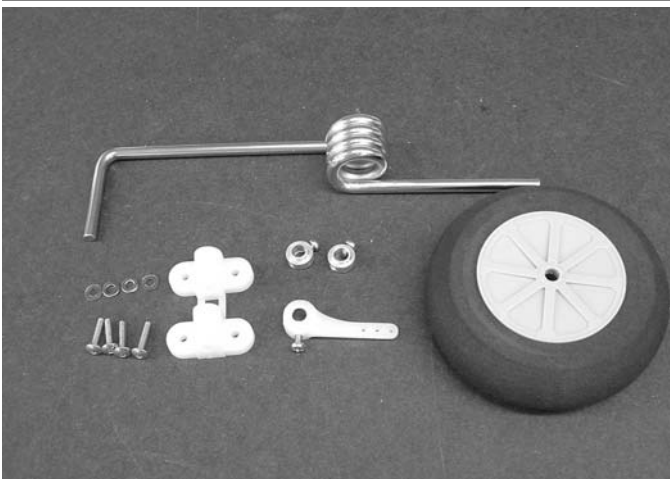

1. Gather the following items:
 - (4) 4-40 x 5/8" socket head screw
 - (4) #4 washer
 - (1) Nylon nose gear block
 - (1) Nose Gear Wire
 - (2) 5mm wheel collar
 - (1) Nylon steering arm
 - (1) set screw for steering arm



3. Screw the nose gear blocks to the firewall with the 4-40 x 5/8" screws and the #4 washers. Don't tighten the bolts until both blocks are in place and the nose gear is inserted in the holes. This will hold the blocks in alignment while you tighten down the bolts. Be sure to use lockite on the bolts.



4. Locate the 1/16" x 18" nose gear steering pushrod (no threads on either end). Make a 90 degree bend 1/2" long on one end. Put the end into the outer hole on the nose gear steering arm and slide the rod into the nylon tube. Insert the nose gear into the bottom block then into a wheel collar, then into the steering arm and finally into the top block.
- Push the nose gear flush with the top of the top block. Tighten the set screw on the wheel collar and the steering arm.

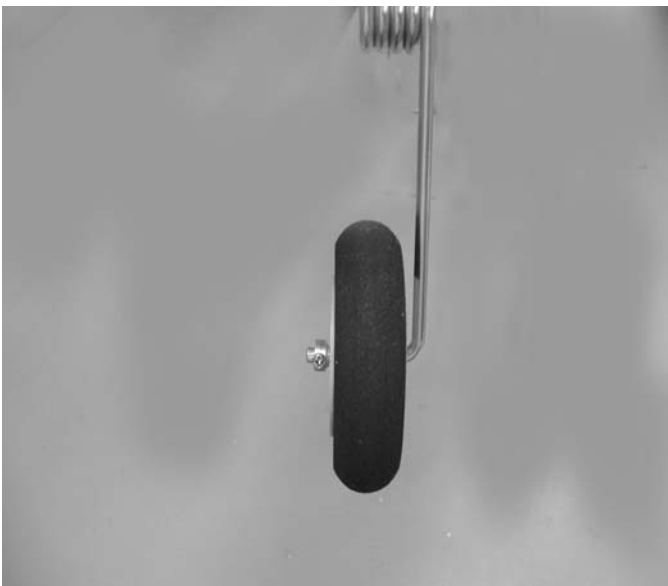

5. Install the nose wheel and secure with the other wheel collar.

ENGINE INSTALLATION

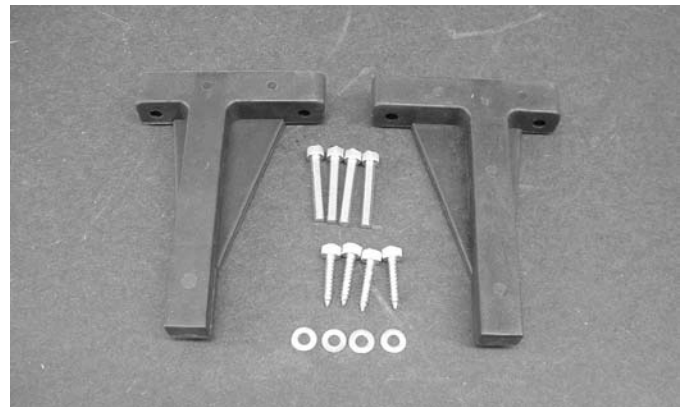

1. In addition to the engine collect the following items:
 - (2) Motor mount
 - (4) 8-32 blind nut(Installed in fuse)
 - (4) 8-32 x 1" socket head bolt
 - (4) #6 x 3/4" sheet metal screw
 - (4) #8 washer

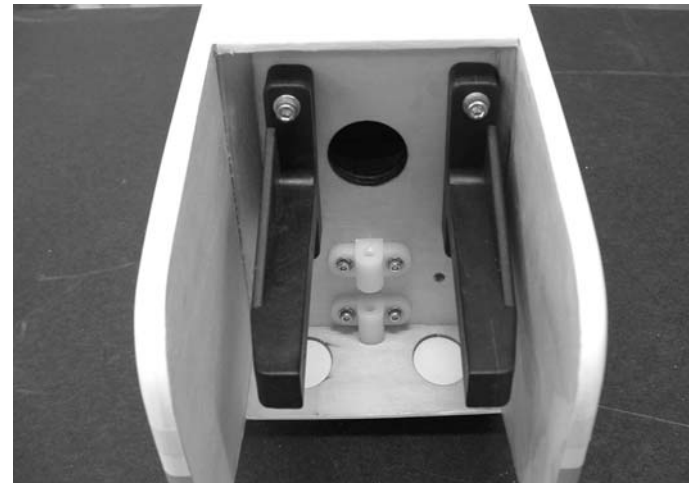

2. Install the mounts in the fuselage using the 8-32 bolts and washers. Be sure to use locktite on the bolts.

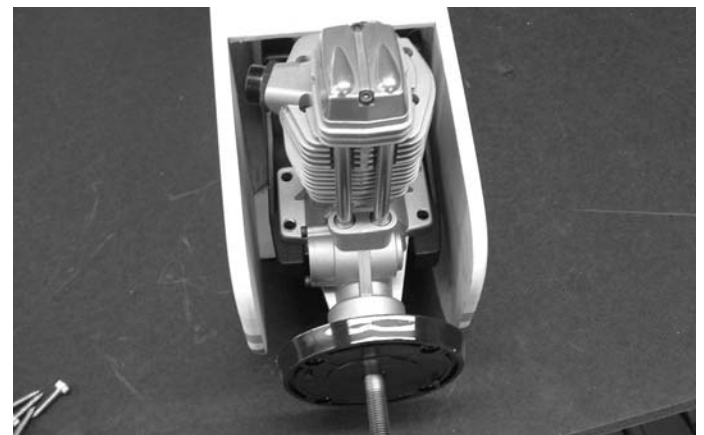

3. Position the engine in the mounts making sure to leave clearance for the spinner back plate on front.

4. Mark the location of the mounting holes and drill a 1/8" hole at each location. Mount the engine using the 6-32 sheet metal screws. Be careful and don't over tighten the screws, they will break easily.

FUEL TANK INSTALLATION

1. Collect the following items:
 - (1) 1/2 x 8 x 12" piece of foam rubber(not included).
 - (1) Assembled fuel tank

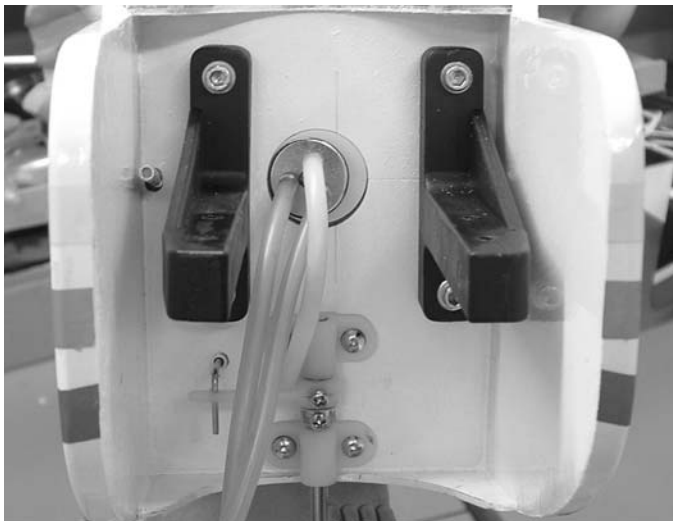

2. Put one of the 1-1/2" wide foam pieces in the bottom of the fuel tank compartment in the fuselage.
3. Taking note of which tube is the vent and which is the fuel pickup,route the fuel tubing into the engine compartment, resting on the half-circle cut-out in the former.



4. Place the fuel tank in the fuselage and through the opening in the bulkhead and into the tank compartment and place the second 1-1/2" piece of foam on top of the tank.
5. Cut the fuel tubing to reach the engine carburetor and muffler and attach these cut ends to the carb and muffler.

HATCH INSTALLATION



1. Slide the hatch tab into the fuse and over the fuel tank compartment and secure with the two 4-40 x 1/2" screws.

CANOPY INSTALLATION

1. Collect the following items:
(1 Tinted Canopy)
2. (Optional) Install any cockpit detail and pilot figure you desire.

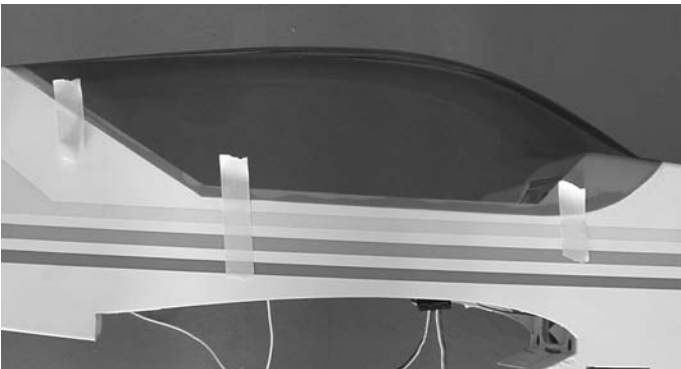

3. The canopy is pre-cut so all that is required is to run a bead of canopy glue around the inside edge. Allow the canopy to overlap the turtle deck at the rear 3/8". Use masking tape to hold in place till the glue dries.

PROPELLER & SPINNER INSTALLATION

The propeller size must be matched to the engine. For example, a .60 may use a 11" diameter prop while a .80 four stroke can use a 13" prop. Follow the engine manufacturer's recommendation for correct propeller sizes or speak to a knowledgeable dealer. It's wise to buy a few spare props, as everyone breaks them occasionally, and particularly often when learning to fly.

Balancing your propeller helps to protect your radio from the damaging effects of vibration. There are good, easy to use prop balancers on the market. We recommend sanding the heavy blade on the curved face, out near the tip, rather than on the flat face. Try to maintain the normal airfoil curvature. Avoid scratches which may cause the prop to break. **Never carve or cut a prop near the hub for any reason** (such as to fit a spinner).

It is equally important to use a correctly sized spinner. The CGP 4-pin spinner (3-1/2") for the Tiger 120 ARF is a rugged precision-molded spinner which does not require any special mounting nuts or screws. **CAREFULLY READ THE SPINNER INSTRUCTIONS AND WARNINGS INCLUDED WITH THE SPINNER.** And remember, although a spinner helps reduce the chance of injury from a rotating prop, extreme caution always must be used when the engine is running.

RUDDER SERVO INSTALLATION

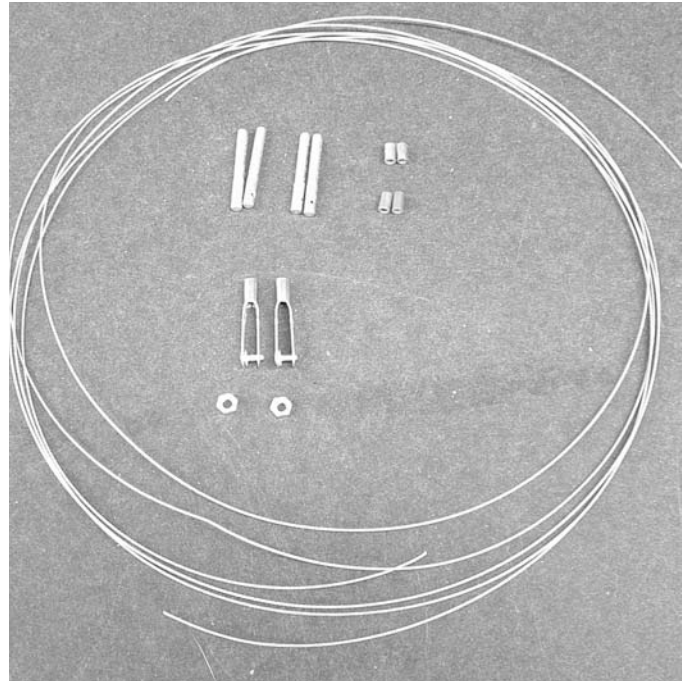

1. Collect the following items:
(1) Braided cable
(2) 4-40 metal clevis
(2) Silicone clevis keepers
(2) 4-40 jam nuts
(4) 4-40 rigging couplers
(4) Cable swages
(1) EZ servo connector

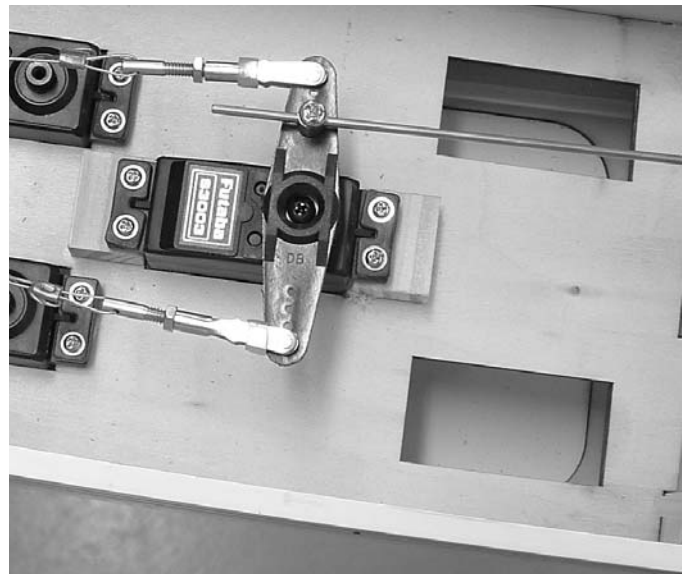

2. Mount the rudder servo on the raised rails in the center of the servo tray using the hardware supplied with the radio.

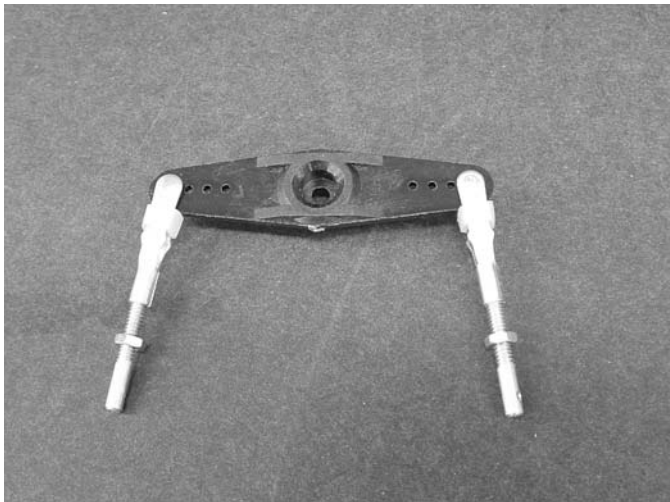

3. Put a silicon keeper on each clevis. Thread a 4-40 jam nut on each rigging coupler and screw on the clevis. Don't screw it all the way in, leave room to tighten the cables. Attach the clevis to the servo arm.

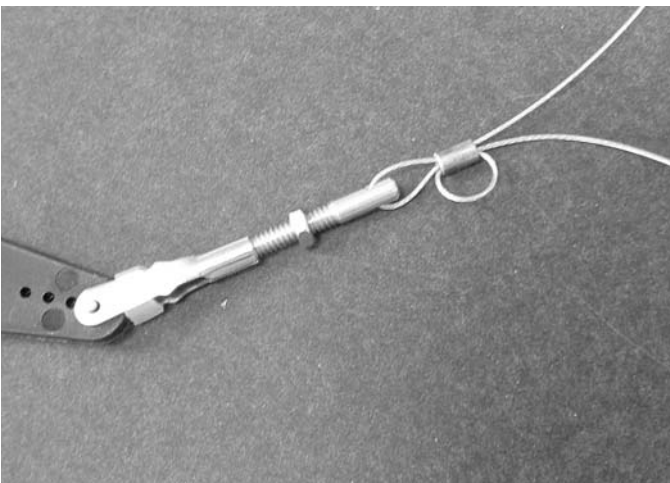

4. Cut the braided cable into two equal pieces. Thread one end through one of the cable swages, through the rigging coupler and back through the swage. Take the end and loop it back through the swage again. Crimp the swage to lock the cable in place.
- Repeat for the other side of the servo arm.



5. Use one of the elevator pushrods to pull the rudder cable out the hole in the rear. Insert the pushrod in the cable outlet and push forward into the servo compartment. Tape the rudder cable to the end and pull out the rear. The cables will need to cross to make the nose gear work in the proper direction.
- Repeat for the other side.



6. Thread the other two 4-40 rigging couplers into the rudder control horns on the rear. Center the servo with the radio and center the rudder. Thread the cable through the swage, through the rigging couplers and back through the swage. Loop back through the swage again. Repeat for the other side. Pull both tight and with everything centered, crimp the two swages.
- Adjust the cables so the rudder has no play in it.

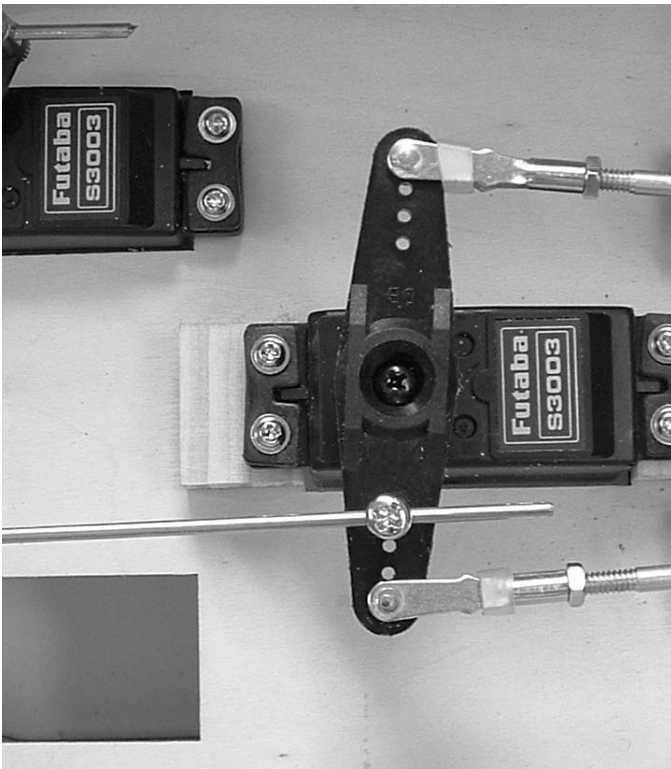

7. Attach the EZ connector to the inside hole on the rudder arm.
- Insert the nose gear steering pushrod in the EZ connector and adjust. Tighten the set screw on top.



3. Mount the two elevator servos using the hardware supplied with the radio. The output arm should be forward.

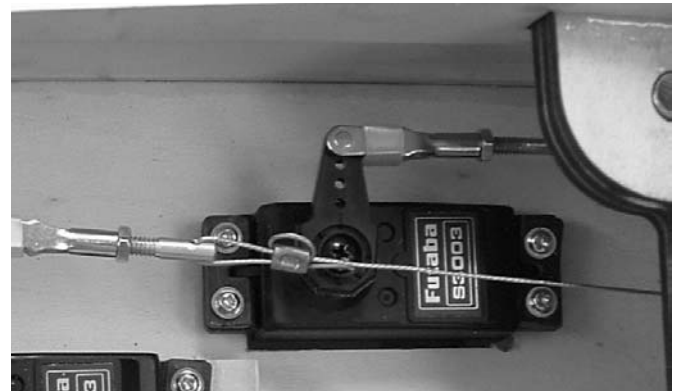

4. Install the silicone clevis keeper on the clevis. Screw a 4-40 nut on the pushrod then the clevis. Attach the clevis to the servo arm. Center the servo with the radio and adjust the clevis till the elevator is neutral. Tighten the jam nut against the clevis. Don't forget the arm retaining screw.

Elevator Servo & Pushrod Installation

1. Collect the following items:
 - (2) 4-40 x 36" pushrods
 - (2) 4-40 metal clevis
 - (2) Silicone clevis keepers
 - (2) 4-40 jam nuts



2. Insert the two 4-40 pushrods into the nylon tubes in the fuselage. Pull them out the rear holes and screw into the elevator horn brackets. They should screw all the way into the clevis.

THROTTLE SERVO INSTALLATION

1. Collect the following items:
 - (1) 2-56 x 18" pushrod
 - (1) Nylon snap link
 - (1) EZ servo connector

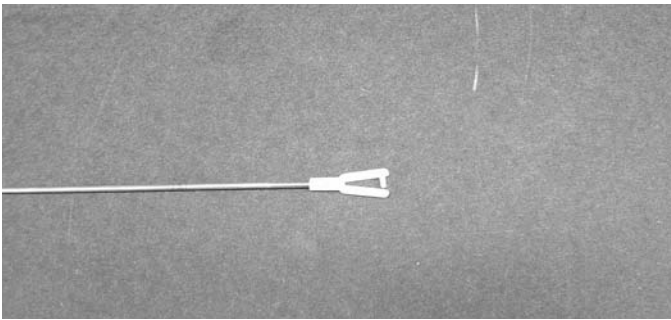

2. Screw the nylon snap link on the end of the 2-56 rod.

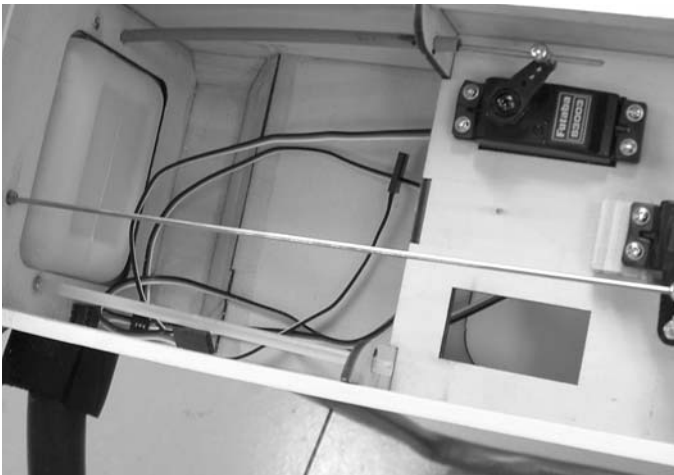

3. Mount the servo on the side of the fuselage that matches your motor. The right side pushrod comes out even with the mount for two stroke engines and the left side comes out high on the firewall for four stroke engines.



4. Attach the ez connector to your servo arm.
5. Slide the pushrod into the nylon tube and attach the snap link to the throttle arm. Fit the other end into the ez connector on the servo. Set the servo to full throttle and open the throttle barrel fully. Tighten the set screw to lock pushrod in place.

1. Insert the Y-harness into the the aileron plug in the receiver and then wrap both the receiver and the battery in the 1/2" foam.

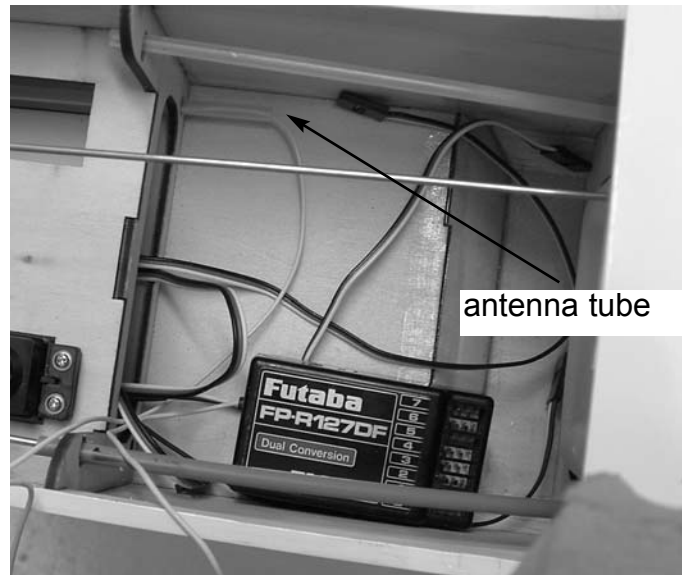

2. Push the receiver antenna into the nylon tube at the front of the servo tray.

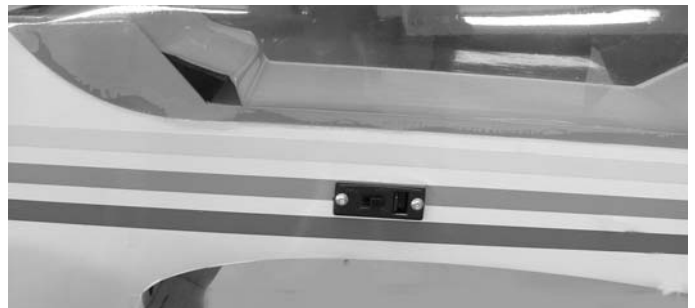

3. The switch can be mounted on the side of the fuselage opposite the exhaust port.
4. Place the receiver just behind the fuel tank and the battery in front of the servos. Plug in all of the servos, keeping both the aileron and the charge cord accessible.
 - If necessary for balance the battery can be moved forward and put under the fuel tank.

RECEIVER AND BATTERY INSTALLATION



MAIN GEAR & WHEEL INSTALLATION

NOTE: If you desire the tail dragger configuration, go to the Landing Gear Installation in the Tail dragger Option section.

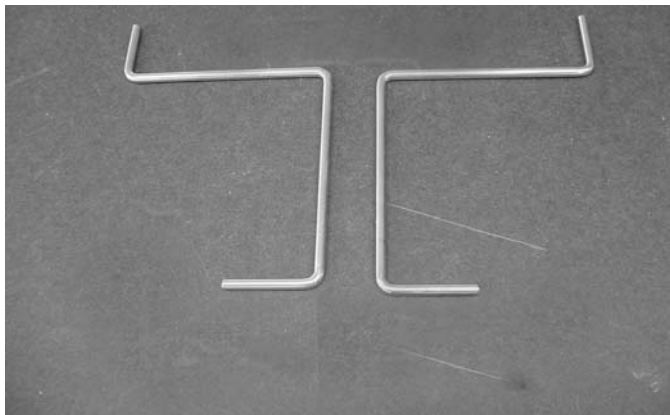

1. Collect the following items:

- (2) Landing gear wire
- (8) #4 x 5/16" screw
- (4) Landing gear strap
- (2) 3-1/4" wheels
- (2) 5mm wheel collar



2. Locate the landing gear slots in the bottom of the wing and remove the covering material.
- Insert the shorter end of the gear into the hole in the bottom of the slot, so that it points toward the center of the wing.
3. Use two nylon straps and four screws on each side to secure the wire gear.



4. Install the wheels on the axles, as shown. The wheel goes on first, followed by the wheel collar, and the set screw.



BALANCING THE MODEL

IMPORTANT: NEVER NEGLECT THIS STEP WITH ANY AIRPLANE. If you try to fly a plane with the balance point behind the recommended range, you run the risk of having an unstable aircraft and the strong likelihood of a crash. **TAKE THE TIME TO PROPERLY BALANCE YOUR MODEL!**

To determine the Center of Gravity, measure back on the fuselage 3-7/8" from the leading edge of the wing. The C.G. range for this aircraft is 3-3/4" to 4-3/4".

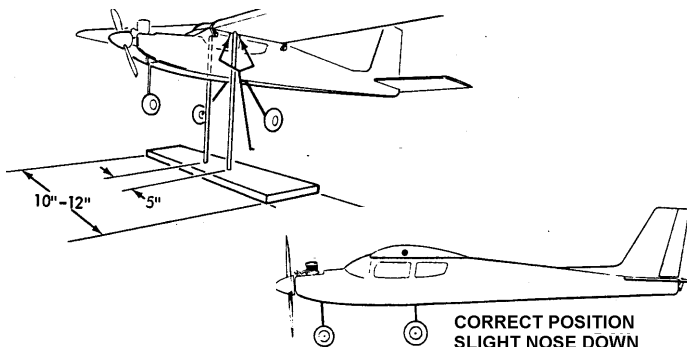

Place the fully assembled aircraft on a model balancing stand, as shown above. You can make this simple set-up with a couple of 1/4" dowels with rounded tops, spaced 5" apart. Alternatively, lift the model under the wing near the fuse by your finger tips. (You may wish to get help from a friend if using the latter method.) Referring to the recommended balance range for your model, move the position of the plane on the balance stand until the model is level or the nose slightly down. If the is tail heavy, shift the R/C equipment away from the heavy end of the model and recheck until the model will balance within the acceptable range. If shifting the R/C gear still doesn't balance the model, add weight to the far end of the nose or tail, respectively, until the model is correctly balanced. The least weight is needed when added as far back or forward as possible. Fasten the weight permanently in place.

TAIL DRAGGER OPTION



NOTE: The tail-dragger option is not recommended for novice pilots. It is best to get plenty of practice with a tri-gear before converting your Tiger 120 ARF into a tail-dragger.

This option might require additional weight added to the nose of the plane to achieve the correct CG Balance. The amount of weight you have to add depends on the weight of the motor you are using.

The tail wheel option shown is available direct from Carl Goldberg Products by calling 678-450-0085 Monday thru Friday 9:00 to 2:00 EST. This package includes all the hardware required to turn the Tiger 120 in to a tail dragger version.

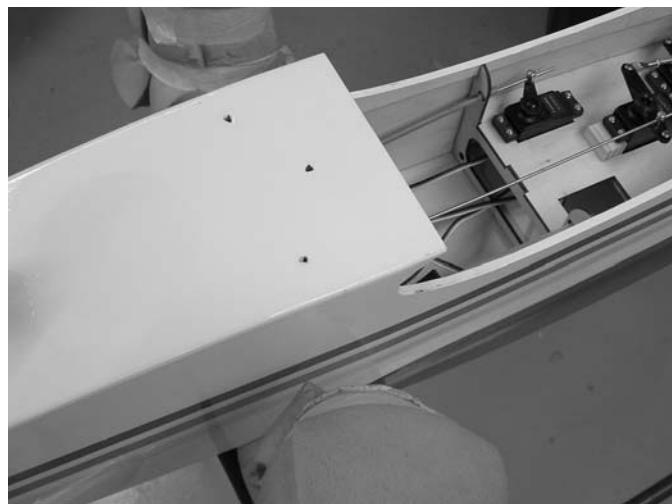

LANDING GEAR INSTALLATION

- To configure your Tiger 120 as a tail-dragger, you will need to purchase the following items. **These items are not included in this kit.**
 - (1) Main landing gear
 - (3) 6-32 x 1/2" socket head screw
 - (2) axles with nuts

- The blind nuts are pre-installed in the fuselage. Rub the covering with your finger and locate the holes and remove the covering.



3. Bolt the main gear in place using the 4mm x 25mm screws.

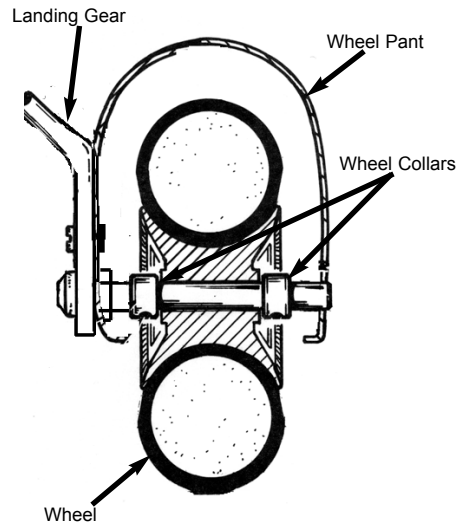

5. Mount the wheel pant on the landing gear along with the wheel collars and wheels.
 - Center the wheel on the axle.
 - Use the 4-40 x 1/2" bolt to hold the wheel pant to the gear.

Be sure to use thread lock on the bolts.

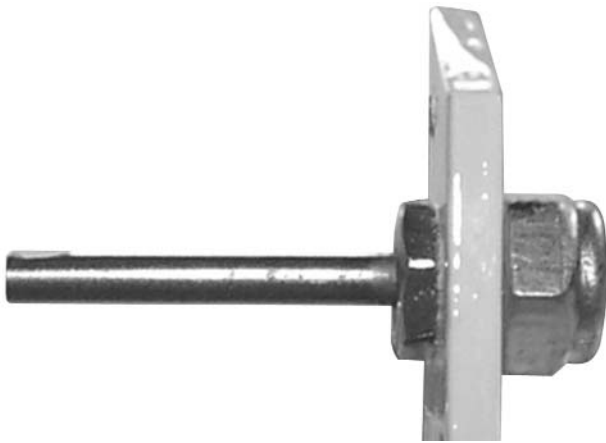

3. Mount the axle to the landing gears.

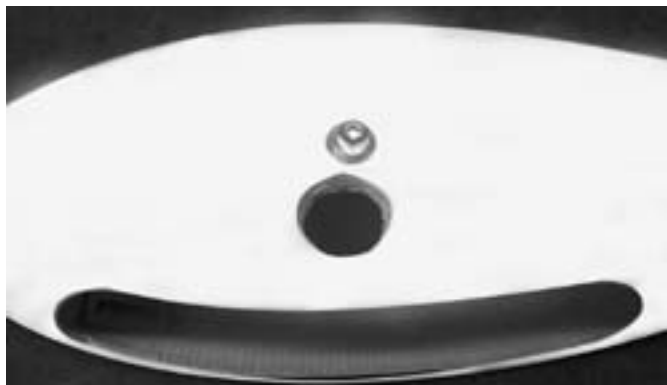

4. Install the blind nut in the wheel pant using the 4-40 bolt to pull it into the hole.

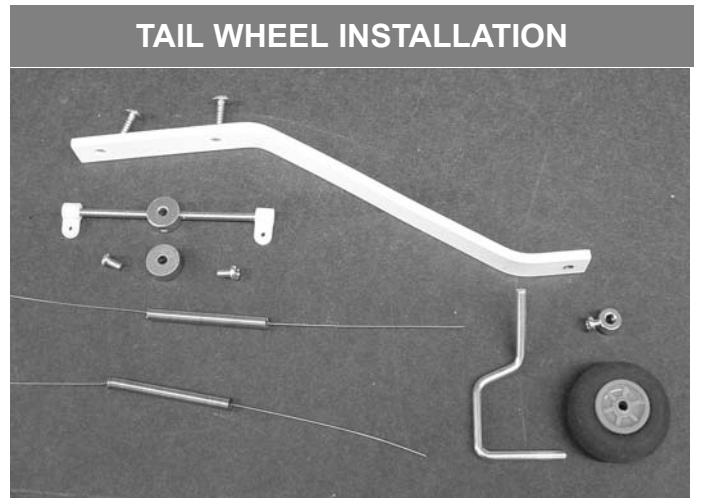

1. Tail wheel package includes mounting hardware.



2. Mount the bracket on the rear of the fuselage using the #4 x 1/2" screws. Install only the rear on first.



3. Mount the two flying wire brackets under the front mounting screw of the tail wheel bracket.



4. Install the wheel collar with just the set screw on the axle bracket and insert through the mounting bracket.
- Install the two nylon pushrod fittings on the ends of the two threaded rods. Screw the threaded rods into the sides of the other wheel collar
- Install the assembly on the top of the axle bracket and tighten the set screw. Make sure the threaded rods are parallel with the axle.



5. Place the wheel on the axle and secure with the wheel collar.

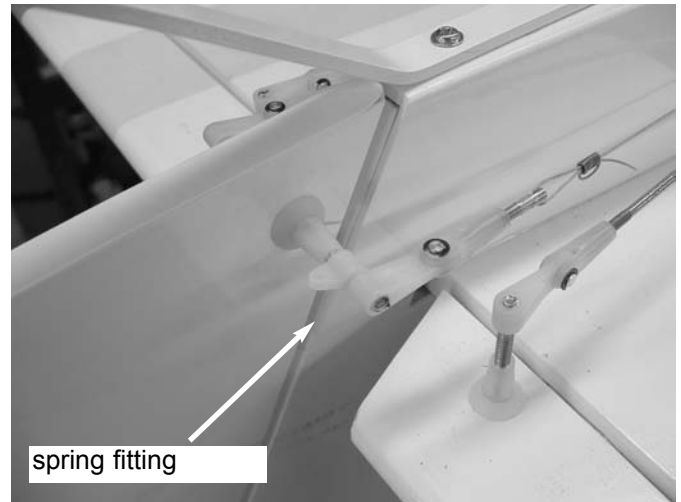

6. If you have not installed the pushrod fitting for the tiller springs you will need to remove the rudder cables and screw them in place.

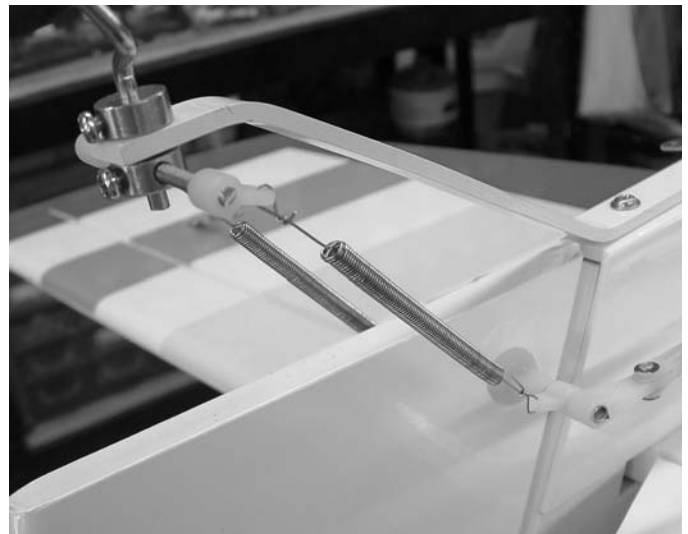

7. Install the springs between the rudder horn and the tail wheel steering arm. Make sure rudder is centered and tail wheel is straight ahead.

FLYING YOUR Tiger 120 ARF

GETTING READY TO FLY

Taking time here really pays off later. Rushing the set-up and testing frequently results in a model that never performs up to its full potential and may even lead to a crash.

CONTROL SURFACE SETTINGS. For the first few flights, even if you are an experienced flier, it is best to set the control surfaces at the GENTLE (LOW) settings. You can then work your way up to the higher settings. The settings for the Tiger 120 ARF are:

	LOW	HIGH
AILERONS	3/8"	1/2"
ELEVATOR	3/8"	1/2"
RUDDER	1-1/2"	

RADIO CHECK. Many an experienced flier has rued the day he neglected to check EVERYTHING! After fully charging the batteries, turn on the receiver and transmitter and actuate all controls many times to make sure all responses are correct. Standing behind the model, the right aileron should go up when the stick is moved to the right. Moving the transmitter stick down should move the elevator up, and vice versa. Also check the wheel movement, which should move right with the right rudder movement. Check that the throttle opens to permit full power when the stick is moved up. Practice steering the model on the ground, with the throttle set at minimum, to keep model moving at a walking pace. **Before and after all tests**, make sure all gear is neatly and firmly in place - engine and servos fastened down, receiver and battery wrapped in foam and secured against shifting, propeller tight, and antenna extended.

Prior to the beginning of each day's flying, make a range check of your equipment in accordance with the manufacturer's instructions. With transmitter antenna collapsed to 6-8", you should have at least 100 feet range on the ground. Check this by turning on both the receiver and transmitter and with the model heading away from you, walk away while transmitting signals. Watch to see that no signals are missed until you are at least 100 feet away. **Remember not to use your transmitter when someone else is flying or testing on the same frequency. DO NOT ATTEMPT FLIGHTS UNLESS ALL THE EQUIPMENT WORKS PERFECTLY.**

After everything checks out, check it again! When you are satisfied with the performance of all equipment functions, point your **TIGER'S** nose into the wind and, gradually increasing to full power, take off for a short (2 to 3-minute) first flight.

Before the second flight, take off the wing and check all screws, radio equipment, engine mounting, muffler, etc. to make sure that nothing has come loose.

Spend the following flights getting familiar with your model and making sure it is properly trimmed for straight and level flight. When you feel comfortable with your model, it's time to try aerobatics.

BEGINNING AEROBATICS

Almost all maneuvers are a combination of loops and rolls, so if you can do these two things, you're off to a good start! We highly recommend the book **Flight Training Course, Volume II**, published by **R/C Modeler Magazine**. Some of the following is taken from this manual, with the gracious permission of the magazine.

Above all, remember that top gun aerobatics are the result of practice. The crisp, graceful movements come from the pilot's willingness to do and do it again. Don't give up; practice really does make perfect!

Which side is up? Learning to recognize which side is up may sound foolish, but many a plane has bitten the dust because the pilot lost track of the plane's position. Other than learning to recognize the plane's silhouette at different angles and attitudes, the best insurance is to force yourself to concentrate on each thing that you do, i.e. making a left turn. If your mind strays and you forget what you're doing, coming back to it can cause a few new grey hairs!

THE LOOP. This is a good first stunt. The model starts flying straight and level into the wind, then pulls up into a smooth, round loop. The up and down portion should be straight, without the plane falling off to the right or left, and the speed should be constant. As the plane finishes the loop, it pulls out straight and level, at the same heading and altitude as when it entered the maneuver.

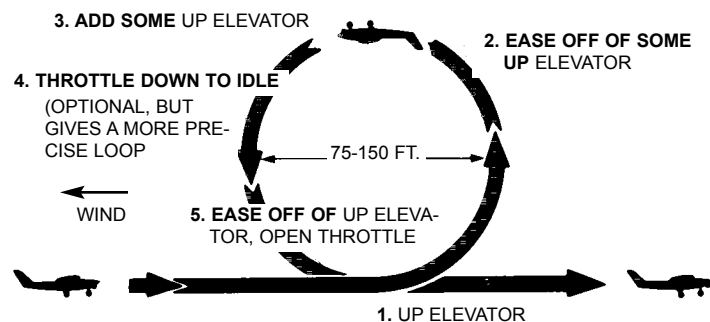

THE HORIZONTAL ROLL. *Important! Always remember that, when the plane is inverted, the elevator works backwards.* Therefore, when the plane is inverted, you give **down elevator**. Also, be sure to fly high enough to give a good margin for error, as your early attempts will probably end up in a 30° dive. We also recommend you practice with the plane in front of you, rather than overhead.

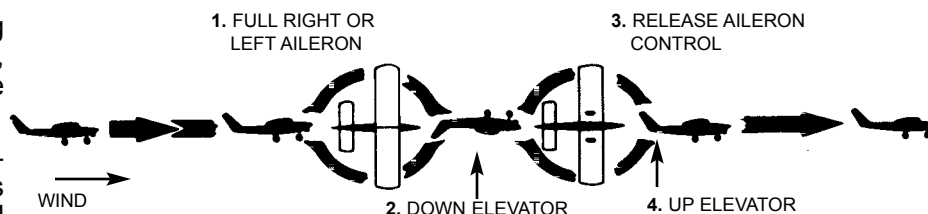

Good luck and happy flying!