

# CUB ARF



## **WARNING**

A radio-controlled model is not a toy and is not intended for persons under 16 years old. Keep this kit out of the reach of younger children, as it contains parts that could be dangerous. A radio-controlled model is capable of causing serious bodily injury and property damage. It is the buyer's responsibility to assemble this aircraft correctly and to properly install the motor, radio, and all other equipment. Test and fly the finished model only in the presence and with the assistance of another experienced R/C flyer. The model must always be operated and flown using great care and common sense, as well as in accordance with the Safety Code of the Academy of Model Aeronautics ([www.modelaircraft.org](http://www.modelaircraft.org)). We suggest you join the AMA and become properly insured prior to flying this model. Also, consult with the AMA or your local hobby dealer to find an experienced instructor in your area. Per the Federal Communications Commission, you are required to use only those radio frequencies specified "for Model Aircraft."

## **LIMITED WARRANTY**

Carl Goldberg Products, Ltd. has inspected and certified the components of this aircraft. The company urges the buyer to perform his own inspection, prior to assembly, and to immediately request a replacement of any parts he believes to be defective for their intended use. The company warrants replacement of any such components, provided the buyer requests such replacement within a period of 90 days from the date of purchase and provided the defective part is returned, if so requested by the company.

No other warranty, expressed or implied, is made by the company with respect to this kit. The buyer acknowledges and understands that it is his responsibility to carefully assemble the finished flying model airplane and to fly it safely. The buyer hereby assumes full responsibility for the risk and all liability for personal or property damage or injury arising out of the buyer's use of the components of this kit.

---

## **CARL GOLDBERG PRODUCTS, LTD.**

---

P.O. Box 818 Oakwood GA 30566 Phone #678-450-0085 Fax # 770-532-2163 [www.carlgoldbergproducts.com](http://www.carlgoldbergproducts.com)

## ITEMS NEEDED TO COMPLETE THIS AIRCRAFT

- 1 RADIO GUIDANCE SYSTEM (4 CHANNEL MINIMUM REQUIRED WITH 5 SERVOS)
- 2 12" AILERON SERVO EXTENSION WIRES
- 1 Y-HARNESS
- 1 ENGINE .46-.61 2-CYCLE, .70-.91 4-CYCLE AND MUFFLER
- 1 CA ACCELERATOR
- 1 2 OZ. BOTTLE CA MEDIUM GLUE
- 1 1/2 OZ. BOTTLE CA THIN GLUE
- 1 20 MINUJET EPOXY
- 1 1/4" FOAM RUBBER

### OPTIONAL:

- 1 1/6 PILOT FIGURE
- 1 SWITCH HARNESS
- 1 Spinner Nut

**NOTE: The Cub ARF comes in two colors  
Red, White, & Blue**

**covering matches: Midnight Blue(#885) and  
White (#870) True Red (Oracover)**

**Yellow:**

**covering matches: Cub Yellow  
Black (Oracover)**

## TOOLS AND SUPPLIES FOR ASSEMBLY.

- MODELING OR UTILITY KNIFE
- WORK SURFACE (24" X70")
- ELECTRIC DRILL
- 1/16", 3/32", 1/8", 3/16", 5/32", 1/4", 5/64"  
7/32" DRILL BITS
- SMALL STANDARD & PHILLIPS SCREW-  
DRIVERS
- MASKING TAPE
- NEEDLE NOSE PLIERS
- MOTO TOOL
- 24" RULER
- FLEXIBLE STRAIGHT-EDGE
- 30-60-90° x 6" TRIANGLE
- SOFT PENCIL
- A FEW STRAIGHT OR "T" PINS
- ADJUSTABLE WRENCH
- WIRE CUTTER (DYKES)
- OPTIONAL HEAT GUN/COVERING IRON
- ACID BRUSH
- ELECTRICAL TAPE
- SOLDERING IRON, FLUX, SOLDER
- PIECE OF MEDIUM SANDPAPER
- 5 FT. LENGTH OF STRING

# INTRODUCTION

## USING THIS INSTRUCTION MANUAL

Before you begin assembling your Cub ARF, take some time to read through this entire instruction book. It is designed to take you step-by-step through the process and to give you added information on engine and radio selection and set-up, balancing your aircraft, and flying your model. The time you spend will speed the assembly process and help you avoid problems.

## PREPARING FOR ASSEMBLY

You will need a work area of approximately 24 x 70" which has been covered to protect it from adhesive, as well as cuts and other damage. Many people cover their work area with a sheet of dry wall (sheet rock) and/or waxed paper to prevent CA Glue and Epoxy from ruining the work surface.

## CONSTRUCTION TIPS

**IMPORTANT: ALWAYS READ A FEW STEPS AHEAD.** This will alert you to coming instructions and will help you plan accordingly.

As you work, CHECK OFF EACH STEP in the box provided, so that you are sure you do not forget anything.

Do not hesitate to ask questions. Your local hobby dealer and area flyers will most likely be happy to help, as they want you to have a successful flying experience. You may also receive technical assistance from Carl Goldberg Products, Ltd. via e-mail (questions@carlgoldbergproducts.com) or by telephone 1-678-450-0085.

## ADHESIVES & GLUING TECHNIQUES

CA adhesives are specially formulated to firmly glue the plywood, hardwood, and balsa used in your model and to withstand the vibration and stresses of high performance flight. However, there are times, such as when you are installing the stabilizer and fin on the fuselage and want more set-up time for careful alignment and positioning, then you should use epoxy. Occasionally, you also will want to use thin CA, which "wicks" into the surrounding areas. Aliphatic resin glue or similar water-based glues can also be used, but they will add to the assembly time because they dry so much more slowly than CA glue. Remember, when ever using any CA, you must be careful to read instructions thoroughly, as you will have only seconds for positioning of parts. Be sure to trial fit parts together before gluing. Also, never use watery THIN type CA glue for gluing plywood and hardwood parts. Thin CA's do not adequately bond these areas.

## CAUTION

Some people may experience an allergic reaction when exposed to fumes from CA glue or epoxy. As with paints, thinners, and solvents, it is always important to use glues only where there is adequate ventilation to carry fumes away. A fan is recommended. Also, special care must be taken when using CA, as it will bond skin as well as other surfaces. Before using any CA, carefully read all label precautions. When using CA, protective eye-wear and care in keeping the glue away from the face is highly recommended. If CA does happen to get into the eye, hold lid open and flush with water only. Seek immediate medical attention.

## COVERING

The Cub ARF is covered in a premium polyester film chosen by many of the world's top flyers for its beauty, toughness, and ease of application and repair. It is not uncommon for ARF's to develop a few wrinkles in transit. If this is true of your model, the situation is easily corrected. Before you begin putting the pieces together, run over the seams of the covering to make sure they are secure. Then apply heat to the center surfaces of each section with an iron (either specially designed for airplane use or the more cumbersome household iron) or use a modeling heat gun. Apply the heat (set at about 350° F), following along with a soft cloth and pressing down on the covering as you go around. This will more firmly set the covering adhesive into the wood and keep your aircraft covering tight and smooth in the future.

One of the great advantages of polyester film is that it can be applied over itself without causing gas bubbles. This allows you to repair your aircraft, as well as to customize it in a number of ways. If, due to a flight mishap, you get a hole or similar covering damage, simply trim away the ragged edges and then apply a patch, following the directions that come with your covering, which is available at your hobby dealer.

# WING ASSEMBLY

## AILERON INSTALLATION

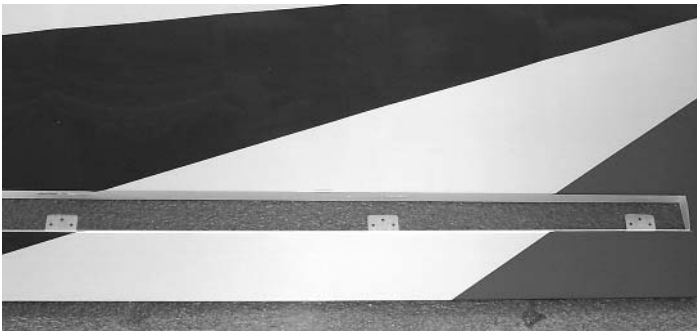

1.  Collect the following parts:

- (1) Left wing
- (1) Right wing
- (1) Left aileron
- (1) Right aileron
- (8) Jet hinge

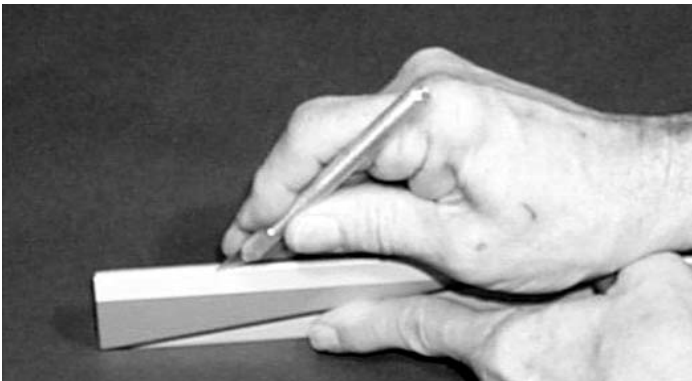

2.  Locate the pre-cut aileron hinge slots in both wing halves. Using a hobby knife (#11 blade), slide the blade into each slot to make sure it is cleanly cut.
- Repeat this process with the ailerons, making sure all hinge slots are clean.

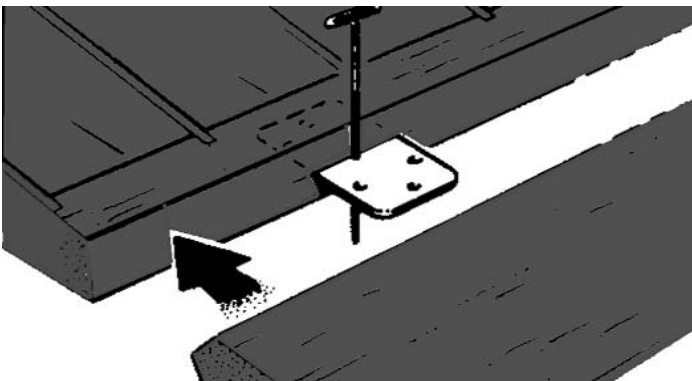

3.  Place a straight pin into the center of each of the four CA hinges.
- Slide each hinge into the hinge slots on one of the wing halves. The pin will prevent the hinges from going further than halfway into the wing.

4.  Select the aileron for the wing on which you are working and insert the exposed half of each hinge into the aileron slots.
- Slide the aileron toward the wing until no gap remains between the aileron and the wing.
5.  Carefully check the alignment of the aileron. It should be centered, with about 1/32" on either end.
- When satisfied with the alignment, remove the straight pins, being sure to keep the aileron tight to the wing. You may wish to apply a few pieces of masking tape to keep the pieces in place.

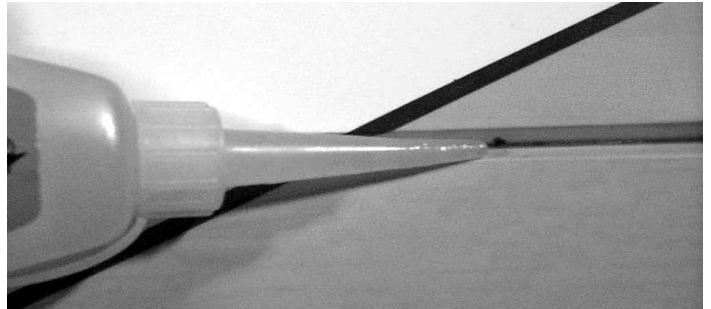

6.  Keeping the aileron and wing in position, apply 3 or 4 drops of thin CA glue to the small exposed area of each hinge.
- Turn the assembly over and again apply 3 or 4 drops of thin CA glue to the exposed hinge surfaces.
- Allow to dry for 10 minutes before flexing the aileron.
7.  Repeat the above steps for the other half of the wing.

## AILERON SERVO INSTALLATION

1.  Collect the following parts:

- (1) Left wing
- (1) Right wing
- (2) Servos
- (2) 12" Servo Extensions
- (1) Wheel Collar
- (1) 24" Thread ( Not Included)

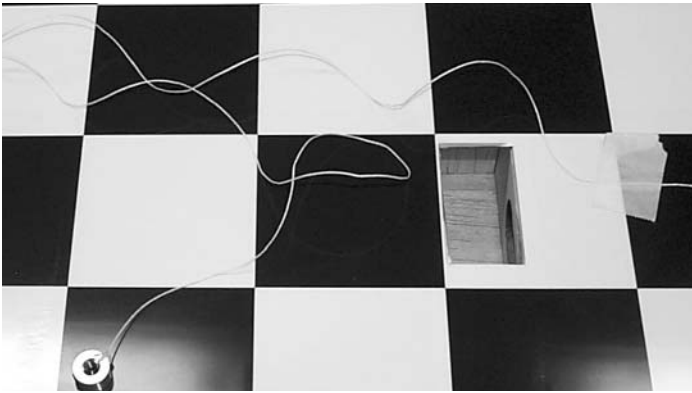

2.  Locate the the servo hole in the bottom of wing.
- Carefully cut the covering over the servo holes.

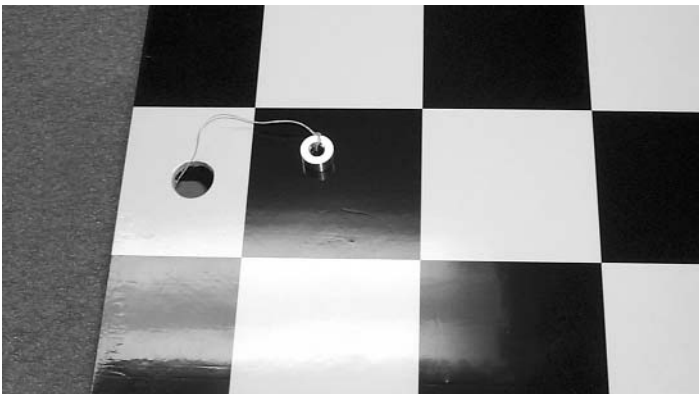

3.  Tie the string to the wheel collar.
- Insert the wheel collar with the string into the servo hole.
- While holding the wing up on the root rib, drop the other end of the string with the nut into the aileron servo hole. Allow the nut to fall down through the wing rib holes till it rest against the center root rib.
- Pull the wheel collar with the string out the hole in the bottom of the wing next to the center rib.

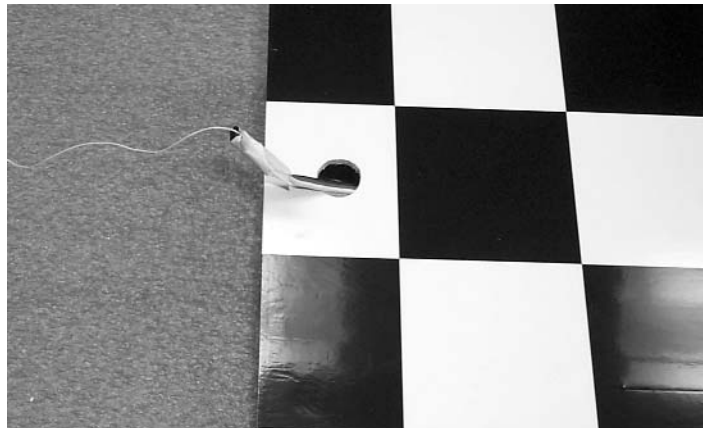

**IMPORTANT!** To ensure that any connections located inside the wing will not come loose, either when the wires are pulled, or during flying, **always tape them securely together with electrical tape.**

4.  Attach the aileron servo wire to the 12" extension and securely tape the connection together.
- Tie one end of the string to the aileron servo extension.
3.  **SLOWLY** pull on the string until the end of the 12" extension comes out of the hole.
- Tape the extension securely to the wing, so that it will not slide back in while you are working.



4.  Using the screws supplied with your radio, screw the servos to the mounting plates in the wings.
- Repeat these steps for the other aileron servo.

## AILERON CONTROL HORN INSTALLATION

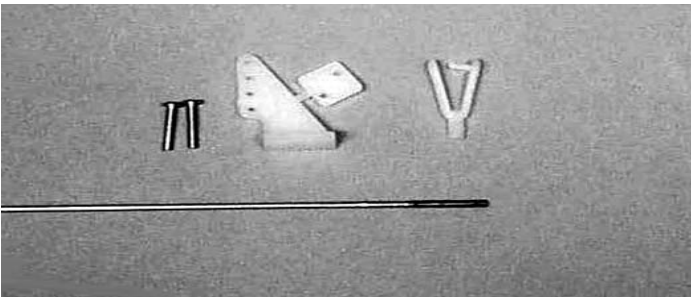

1.  Collect the following items
  - (2) Large control horn with back plate
  - (4) 2-56 x 3/4" screw
  - (2) .072 x 10" threaded wire
  - (2) Snap link
  - (1) Nylon Swivel Keeper

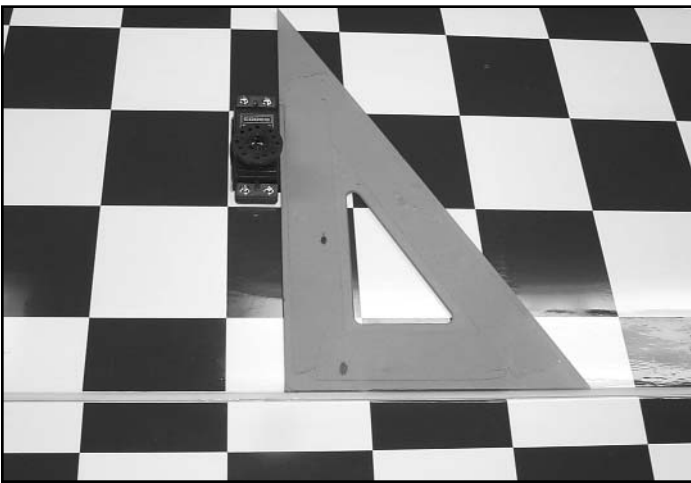

2.  With the aileron servo in place, make a mark at a 90° degree angle to the trailing edge and in line with the side of the servo.

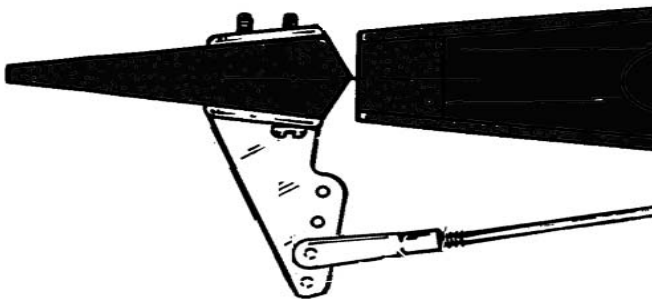

3.  Position the control horn so that the snap link holes are on the mark just made and right next to the hinge line, as shown.
4.  Using a 5/64" drill bit, make a pilot hole in each screw location.
  - Mount the control horn with the 2-56 x 3/4" screws.

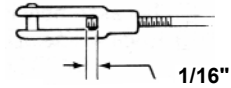

5.  Thread the .072 x 10" rod onto the snap link. Make sure the rod shows in the center of the snap link.
  - Place the snap link in the second hole from the top on the control horn.



6.  Making sure the aileron is in neutral (level) position, mark where the wire meets the hole on the servo arm.
  - Remove the wire and cut it about 1/2" beyond the mark.



- Make a 90° bend (or a "z" bend, if preferred) in the wire and insert the wire in the servo arm.
- Secure the wire with a nylon swivel keeper.
- Repeat for the other servo in the other wing.

## WING STRUT BRACKET INSTALLATION

1.  COLLECT THE FOLLOWING ITEMS:  
 (4) STRUT MOUNTING BRACKET  
 (4) #2 x 3/8 SHEET METAL SCREW

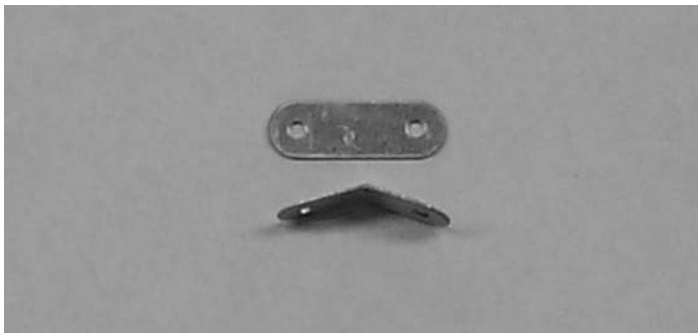

2.  Place a small drop of thin CA glue into the wing strut mounting holes found in the bottom of the wing above and below the aileron servo.  
 Slightly bend the strut mounting bracket in the middle.



3.  Using #2 x 3/8 sheet metal screw, mount the bracket so that it is pointing to the fuselage.

## MOUNTING WING TO FUSELAGE

1.  Collect the following items:  
 (1) Right wing  
 (1) Left wing  
 (2) 5/16 x 1-1/2" dowel  
 (1) 3/4" x 17-1/2" aluminum tube



2.  Using epoxy, mount the 5/16 x 1-3/4" dowels into the holes in the notch of the leading edge of the wing. Make sure to leave about 1/2" of dowel sticking out of the front of the wing. You may wish to slightly taper the exposed dowel ends for ease of insertion into the fuse holes.

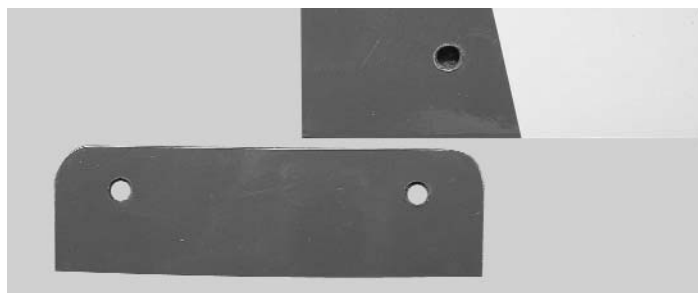

5.  Insert the aluminum tube into one wing half and push the tube into the wing until it stops. Then insert the other wing half onto the tube and slide the wing halves together.  
 Tilt the leading edge of the wing down into the fuselage and insert both dowels in the holes that are in the front of the fuselage  
 Insert a 1/4-20 x 2" nylon bolt into each hole in the wing bolt pad and then insert each screw into the holes near the trailing edge of the wing.  
 Tighten both screws down until they are tight.

## STAB INSTALLATION

1.  Collect the following parts:  
 (1) Stabilizer  
 (1) Wing/fuse assembly

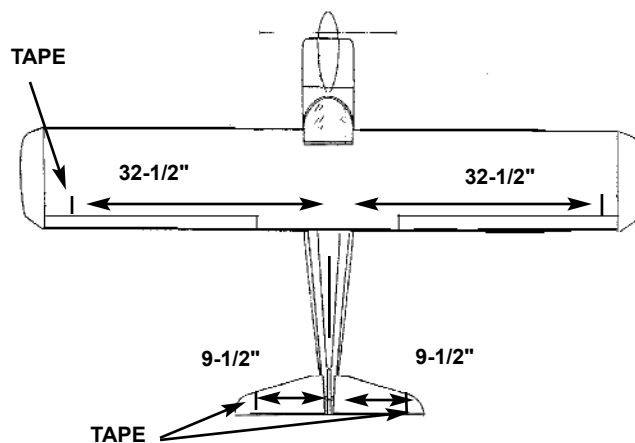

3.  Place a piece of masking tape on each wing tip, just above the aileron hinge line, as shown above.  
 Measuring out from the center joint of the wing, make a mark on the tape at 32-1/2". Repeat for the other side of the wing
4.  Place two strips of masking tape along the edge of the stab, next to the outer stab tips and above the hinge line.  
 Measure the total length of the stab along the hinge line and locate the centerline with a mark.  
 Measure 9-1/2" out from the centerline and make a mark on the masking tape on both the left and the right side of the stabilizer.

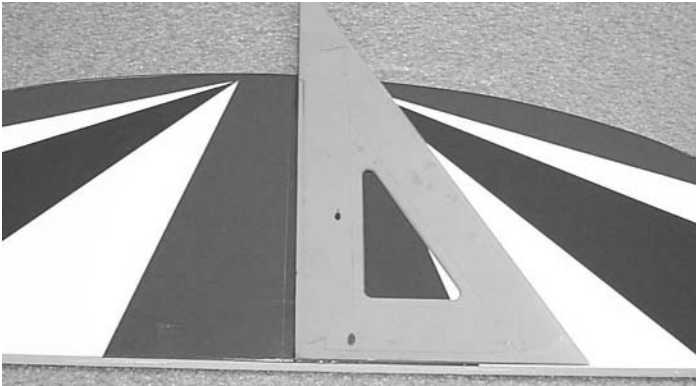

5.  From the center point on the stab, draw a vertical line up to the top of the stab.
- Place masking tape on the top of the fuse, just in front of the stab.
- Measure and mark the center point on the tape.

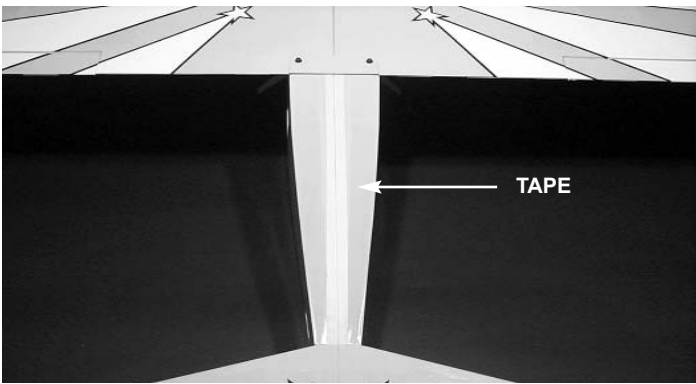

- Mark a centerline on the fuselage, just behind the wing.
- Place a piece of masking tape along the top of the fuselage, as shown, and draw a line from the center mark in front of the stab up to the center mark below the wing.

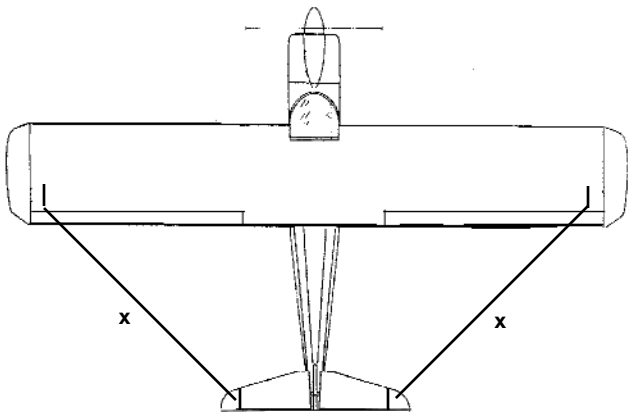

6.  Place the stab on the platform with the center of the stab lined up with the center point on the fuse.
- Measuring from the mark on each wing tip to the mark on the stab tip, make sure the distance "X" on the right side is the same as the distance on the left side.

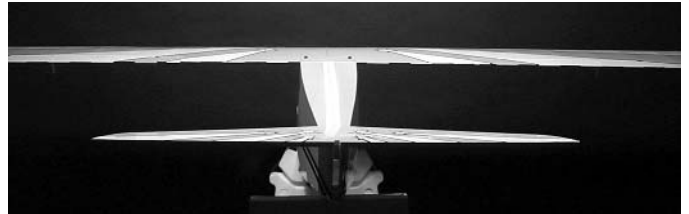

7.  Check to see that the stab is level (parallel) with the wing. If necessary, insert paper strip shims to achieve proper alignment.

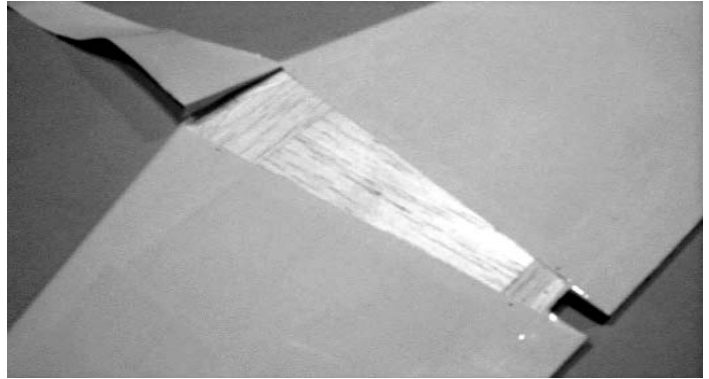

8.  When satisfied with the alignment of the stab, temporarily tape it securely in place.
- Mark the area on the bottom of the stab where it rests on the fuse.
- Remove the stab from the fuse and, working 1/4" inside the drawn lines, carefully remove the covering from the bottom of the stab. **BE CAREFUL TO AVOID CUTTING THE WOOD.**
9.  Spread epoxy on both the bottom of the stab and the stab platform of the fuse.
- Replace the stab on the platform and, after again checking the alignment of the stab to the wing, allow the epoxy to dry thoroughly.



1.  Insert the elevator joiner in through the space behind the stabilizer slot.





2.  Slide the fin mounting post into the rear of the fuselage.
  - Check the fit. The fin should fit easily into the slot at the rear of the fuselage and the notch in the rear of the stab. The fin should stand upright by itself. Enlarge the notch, if necessary.



4.  When satisfied with the fit, mark the location of the fin on the fuse and stab by drawing a line on both sides of the fin, as shown.



- TAKING CARE NOT TO CUT INTO THE WOOD STRUCTURE UNDERNEATH**, and working inside the drawn lines, carefully remove the covering where the fin mounts on the fuse and stab.

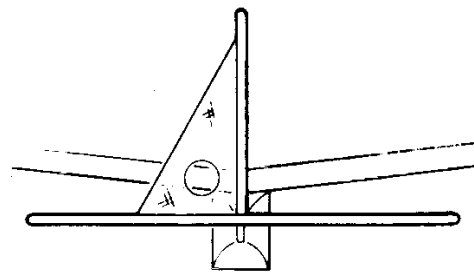

5.  Remount the fin on the fuse and, using a 90° triangle, make sure the fin is perpendicular to the stab.
  - When satisfied with the fit, remove fin and mix up a couple of spoonfuls of epoxy.
  - Apply a **THIN**, even coat of epoxy on the bottom of the fin and along both sides of the fin mounting posts. Avoid too much glue, which will squeeze out from underneath the fin.
  - Mount the fin on the fuse and place the triangle against the fin to make sure it is perpendicular.
  - Use masking tape to secure the fin and triangle in position until the epoxy is thoroughly dry. Make sure not to glue the triangle!

### ELEVATOR HINGING

1.  Collect the following items:
  - (1) Rudder
  - (2) Elevator
  - (6) Hinges



2.  Take three hinges and, as with the aileron hinge installation, insert the hinge into the elevator, using straight pins to ensure the hinge stays centered between the stabilizer and the elevator.
  - Inset the elevator joiner wire into the hole and slot in the elevator, then slide the exposed side of the hinges into the slots in the stab until the pins touch both the stab and the elevator.

3.  Remove the pins in each hinge and, keeping the elevator/stab assembly in position, apply 3 or 4 drops of thin CA to each hinge, on both the top and bottom sides of the stab.
- Allow ten minutes for the CA to cure before flexing the elevator. Then install the second elevator.

### RUDDER HINGING

1.  Collect the following items:
  - (1) Rudder
  - (1) Tail Wheel Bracket
  - (3) Hinges

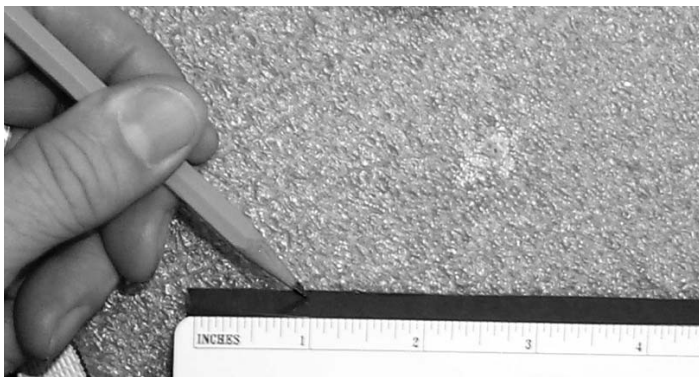

1.  Mark 1" up from the bottom of the rudder.

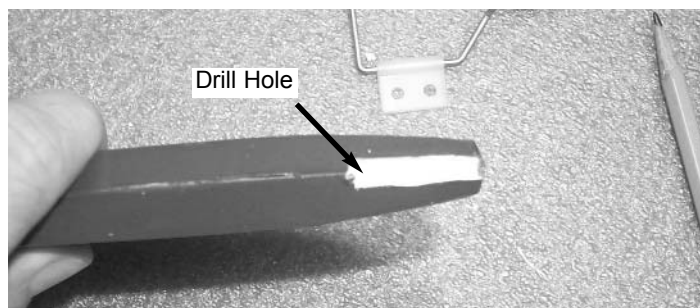

2.  Drill a 3/32" hole on the hinge line at the 1" mark you just made.
- Cut a slot along the rudder hinge line for the tailwheel wire to fit into.

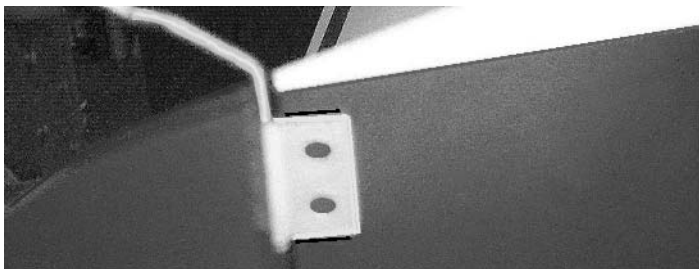

3.  Mark where the tail wheel bracket meets the fuselage.



4.  Make a slot on the hinge line in the fin post for the nylon tail wheel hinge bracket.
- Place one drop of oil on the nylon hinge where the wire goes through the hole.
- Mix some epoxy for the nylon tail wheel hinge, the glue the tail wheel hinge into the rudder post.
- Install the hinges into the rudder and glue the rudder in place using the same hinging method used for the elevator and ailerons. Remember to leave a 1/32" gap at the top of the rudder.

### ELEVATOR PUSHROD

1.  Collect the following items:
  - (1) Control horn
  - (2) 2-56 x 3/4" machine screw
  - (1) .072 x 27-1/4" Threaded Rod
  - (1) Nylon Clevis
  - (1) Silicone Clevis keeper

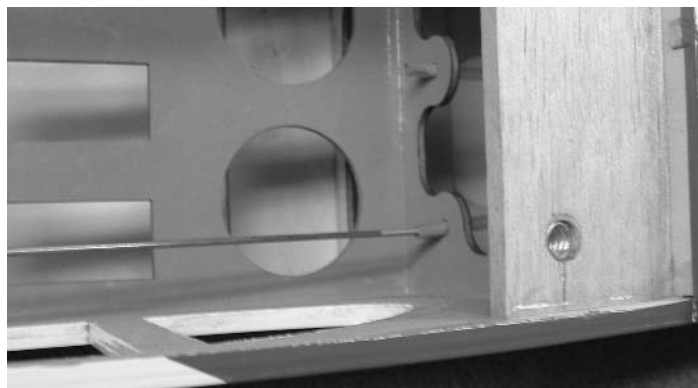

2.  Insert one of the .072 x 27-1/4" threaded rods into the elevator pushrod tube.

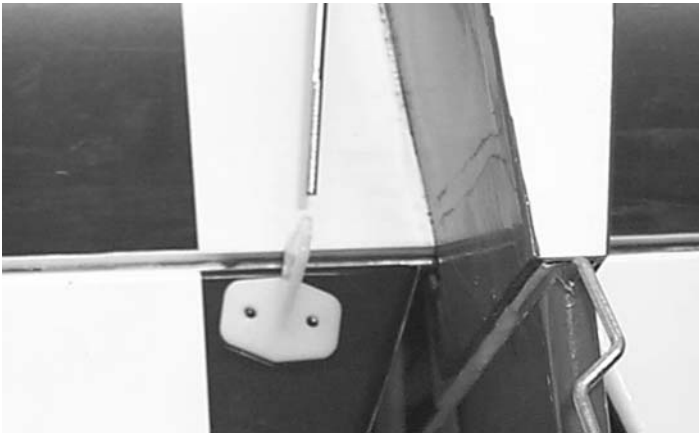

3.  Turn the fuselage over and pull the pushrod out to the elevator.
- Place the control horn so that it is at the end of the pushrod and the clevis holes are over the hinge line.

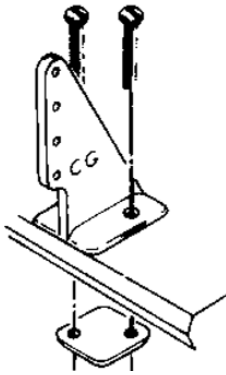

4.  Mark the location of the mounting holes.
- Using a 5/64" drill bit, drill the holes through the elevator.
- Using two 2-56 x 3/4" screws, screw the control horn and the backplate tightly to the elevator.

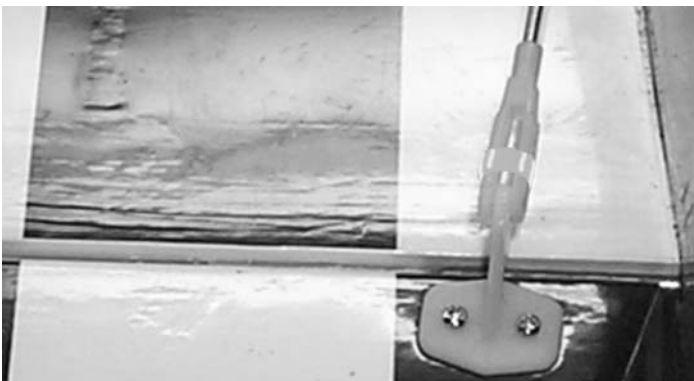

5.  Place the silicone keeper over the pushrod.
- Thread the nylon clevis onto the pushrod.
- Snap the clevis onto the outer hole in the control horn.
- Pull the silicon keeper onto the nylon clevis.

## RUDDER PUSHROD

1.  Collect the following items:
  - (1) Control horn
  - (2) 2-56 x 3/4" machine screw
  - (1) .072 x 27-1/4" Threaded Rod
  - (1) Nylon Clevis
  - (1) Silicone Clevis keeper



2.  Insert the rudder pushrod just like you did the elevator.
- Place the control horn so that it is at the end of the pushrod and the clevis holes are over the hinge line.
- Mark the location of the control horn mounting holes. Try to mount the control horn over the tailwheel wire so that the mounting screws are on either side of the wire in the rudder.

## ELEVATOR & RUDDER SERVO

1.  Collect the following items:
  - (1) Fuselage
  - (2) Servo with hardware (Not Included)
  - (2) Swivel Keeper



2.  Mount the elevator servo in as shown above.
- Tape the elevator and the rudder so that they are level with the stabilizer and the fin.



3.  Measure the length of the pushrod to the servo arm hole and make a 90 degree bend.
- Mount the swivel keeper on to the wire and clip in place.



4.  Repeat steps 2 & 3 for the rudder servo.
- The servo should look the same as above when finished.

### INSTALLING THE ENGINE

1.  Collect the following items:
  - (2) Motor Mounts
  - (1) Engine
  - (4) 8-32 x 3/4" Philip Head Screw
  - (4) 8-32 x 1" Philip Head Screw
  - (4) #8 Washer
  - (4) 8-32 Nylon Locking Nut

#### Note:

Your engine installation may be different then shown depending on the motor you use.

#### Caution:

Always use thread lock on any type of machine bolt and nut.

#### Note:

This installation is for a inverted mounted engine. If you wish to have a side mounted engine, then your installation steps may be different. You also might need a round style motor mount and not use the one beam mounts supplied in this kit..



2.  Using thread lock, mount the motor mounts to the firewall using 8-32 x 3/4" screws with #8 washers.

#### Note:

The firewall is pre-drilled so that the mounts have an opening of 1.67" this will fit a O.S. 70 Surpass up to a O.S. 90 Surpass. The motor you choose might require a different spacing. The blind nuts can be removed and changed if required.



3.  Place your motor on the motor mounts,
- Center the motor between the mounts.
- Measure from the firewall to the prop drive washer 4-7/8 ".
- Mark one of the engine mounting holes location.
- Using a 3/16 bit, drill on the mark.
- Mount the motor to the motor mount using a 8-32 x1" bolts and the #8 locking nut.
- repeat for the other three motor mounting holes.



3.  Drill a 1/8" hole in the firewall in position with the throttle arm.
- Insert the 1/8" x 9" nylon tubing in the hole.



4.  Let the tubing exit into the fuselage towards the throttle servo mount.
- Insert the throttle pushrod thru the tubing starting at the firewall.
- Insert the bent end into the throttle arm on the carburetor.

### THROTTLE PUSHROD INSTALLATION

1.  Collect the following items:
  - (1) .072 x 15" threaded wire
  - (1) 1/8 x 9" nylon guide tubing
  - (1) Snap nut
  - (1) Pushrod connector
  - (1) 4-40 x 1/4" screw

**NOTE:** The following photos and instructions are for mounting a 4-cycle engine. Other engines might require different steps for installations.

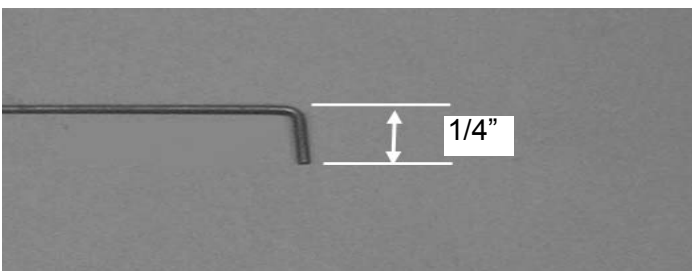

2.  Mark 1/4" from the end of the .072 wire and make a 90° bend.

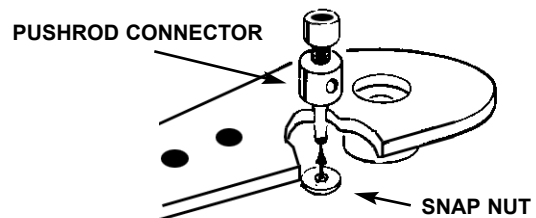

5.  Attach the Pushrod connector to a servo arm same as shown above.



6.  Install the throttle servo into the servo tray.
  - Insert the pushrod wire through the connector on the servo arm.
  - mount the servo arm onto the servo.

**Note:**

**Do not cut the remaining pushrod wire till you align the servo with the radio.**

**FUEL TANK ASSEMBLY**

1.  Gather the following items
  - (1) fuel tank
  - (1) rubber tank stopper
  - (1) clunk
  - (1) 3mm x 25mm screw
  - (1) cap washer large
  - (1) cap washer small
  - (1) 3mm x 40mm brass tube
  - (1) 3mm x 60mm brass tube
  - (1) silicone tube 4mm x 80mm
  - (2) silicone tube 5mm x 165mm



2.  Insert the 3mm screw through the center hole in the large washer, through the center hole in the rubber washer against the large side, and screw the small washer on the back side.



3.  Insert the brass tubes through two of the holes. They should be arranged so as the long one will be on the right side of the plane and the short one on the left side.
  - The tubes should extend out the front of the cap 5/8". Bend the long tube up at about a 20 degree angle. This should be adjusted so the end of the tube almost touches the top of the tank when installed.

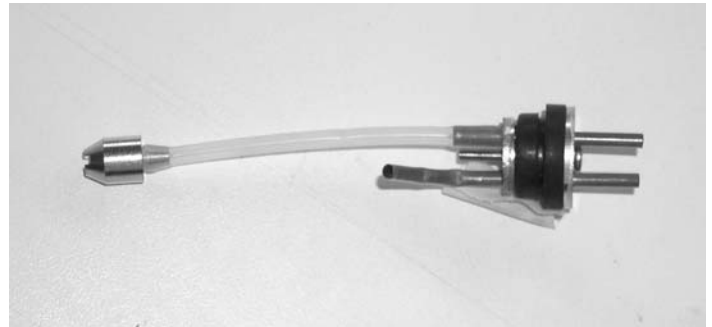

4.  Install the 4mm silicone tube to the short brass tube and install the clunk to the other end of the silicone tube. This is the fuel pick-up and must be free to "flop" around in the tank so it can pick up fuel in any attitude.



5.  Install the assembly into the tank so the vent tube is turned up to the top of the tank and is positioned on the right side of the tank. Tighten the screw to expand the rubber cap. Don't over tighten or you could split the tank.

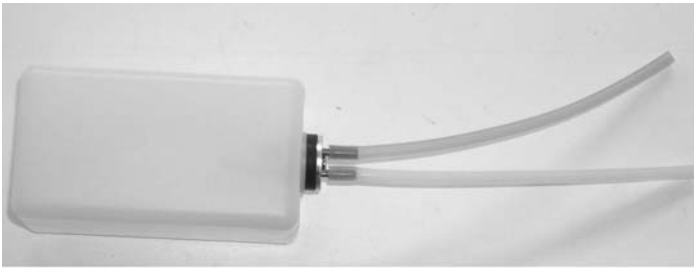

6.  Attach the two pieces of 5mm tubing to the two tank outlets. They are different colors so you can tell which is the vent and which is the fuel pickup after the tank is installed. Make a note of which color you attach to which tube. The short brass with the clunk is the fuel pickup and must go to the carburetor. The long brass tube is the vent and should go to the pressure outlet on the muffler.
- Set tank aside till ready to install.

### FUEL TANK INSTALLATION

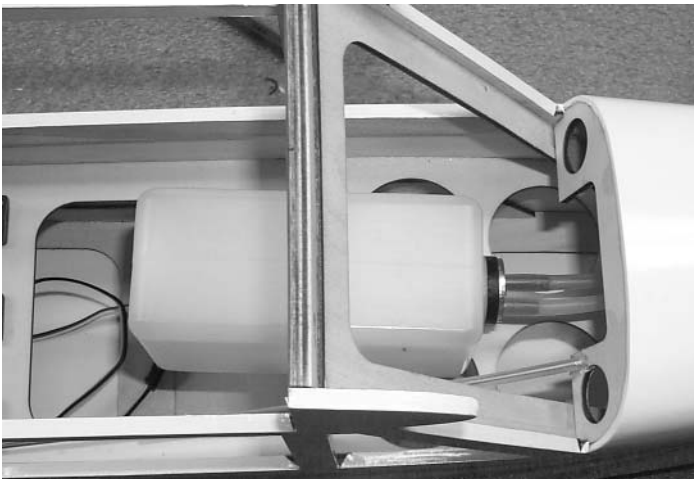

1.  Making sure the vent tube is pointing up inside the tank, install the fuel tank through the fuselage cabin.
- Insert the fuel lines through the hole in the firewall



2.  You can insert some optional foam rubber under the fuel tank to help hold the tank in place.
- Connect the fuel lines to your motor.

### MAIN LANDING GEAR

1.  Collect the following items:
  - (4) 1/2" Brass Straps
  - (4) 2-56 Hex Nuts
  - (4) 2-56 x 5/16 Philip Head Screw
  - (2) Main Landing Gear Wire
  - (2) 1/2" Nylon Landing Gear Straps
  - (4) #2 x 5/16 Sheet Metal Screw
  - (4) #2 x 3/8 Sheet Metal Screw
  - (4) 5/32 Wheel Collars with Set Screws
  - (2) 3-1/4" Wheels
  - (2) Small Rubber Bands
  - (2) Covered Landing Gear Fairing



1.  Bend the 1/2" brass straps the same as you did on the wing.
- Insert the 2-56 x 5/16 screws through the front of the landing gear fairing.
- Place a brass strap and a 2-56 hex nut and tighten. (**Don't Forget to use Lock tight**).
- Repeat this for the other landing gear fairing. Make sure you make a left and right side.



2.  Insert the Main landing gear wire into the hole in the bottom of the fuselage.
- Hold the landing gear in place by using the 1/2" nylon straps across the wire and #2 x 3/8" screws.



3.  Mount the fairing on the bottom of the plane as shown above.
- Drill a 1/16" hole for the brass straps and screw them down with the #2 x 3/8 screws.
- Place the small rubber band over the landing gear wire and into the notch on the fairing.



4.  Place one 5/32 wheel collar on the end of the axle.
- Insert the wheel onto the axle.
- Place the second 5/32 wheel collar on the out side of the wheel.
- Center the wheel and the wheel collars on the axle.
- Tighten both the inside and the out side collars.
- Repeat for the other side of the landing gear.

## TAIL WHEEL

1.  Collect the following items:
  - (1) 1-1/2" Wheel
  - (1) 3/32 Wheel Collar with Set Screw

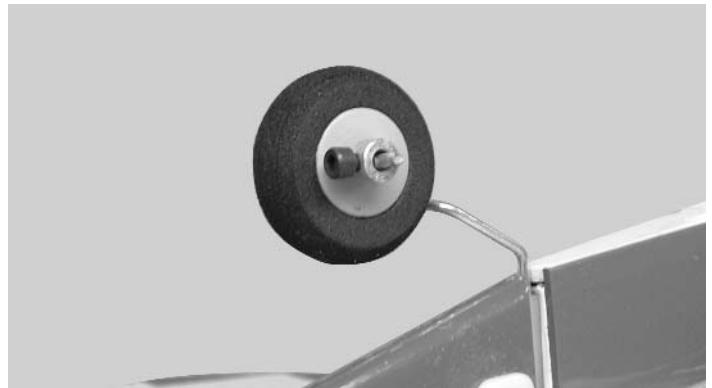

2.  Slide the 1-1/4" wheel onto the tail wheel bracket.
- Place a 3/32" wheel collar on the axle and tighten the set screw.

## COWL INSTALLATION

1.  Collect the following items:
  - (1) Cowl
  - (1) Fuselage
  - (4) #2 x 3/8 Sheet Metal Screw

**Note:**  
**Your cowl installation may be different then shown depending on the motor used.**



2.  Very carefully start removing the side of the cowl where the engine will protrude.
- Make sure that you leave space around the engine so that the cowl will not rub on the engine.





3.  Keep the hole in the front of the cowl centered on the engine.



4.  Screw the cowl to the fuselage using #2 x 5/16 screws.

## WINDOWS

1.  Collect the following items:
  - (1) Fuselage
  - (1) Windshield
  - (1) Side windows (Right & Left)

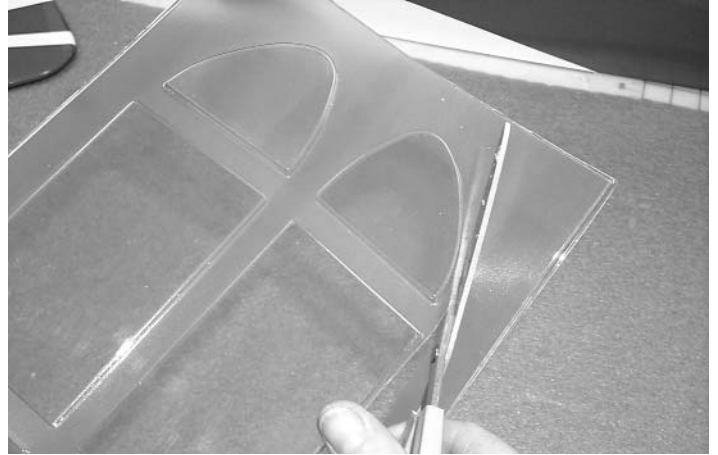

2.  Using scissors, cut around the outside of the windows leaving a 1/8" flange around the edge.

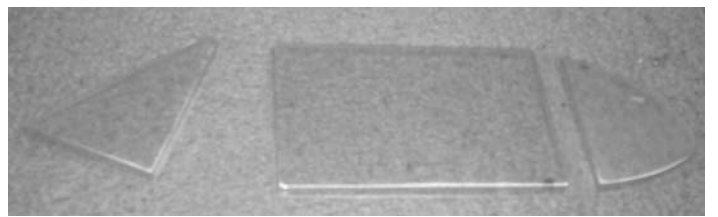

3.  Keep the two rear windows together but, cut the front window off by cutting down the middle of the space between the 1st and 2nd window.

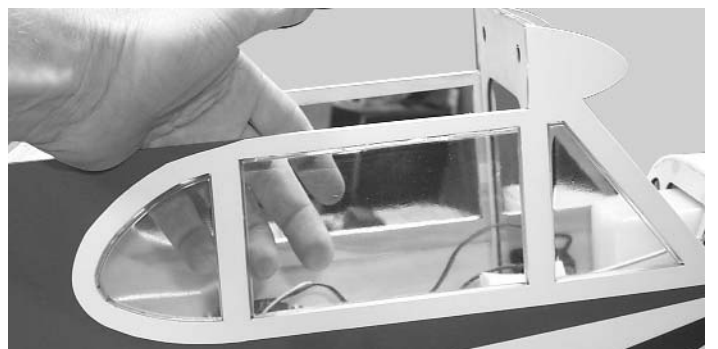

4.  Glue the windows in using a small amount of medium CA glue or a canopy glue, on the flange around the outside of the window.
  - Holding or tape the window in place till the glue hardens.

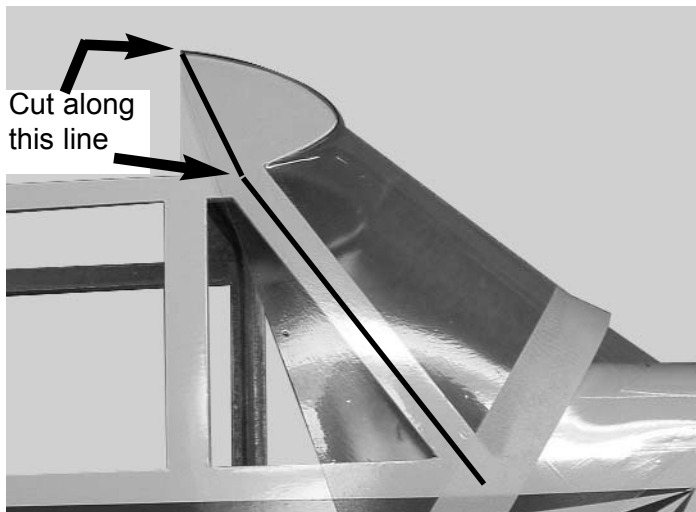

5.  Temporary tape the front Windshield in place on the fuselage.
- Mark the side of the Windshield using a pen or pencil where shown above.
- Remove the Windshield and cut along the line that you just drew.
- Cut the top of the windshield even with the back of the wing mount former.

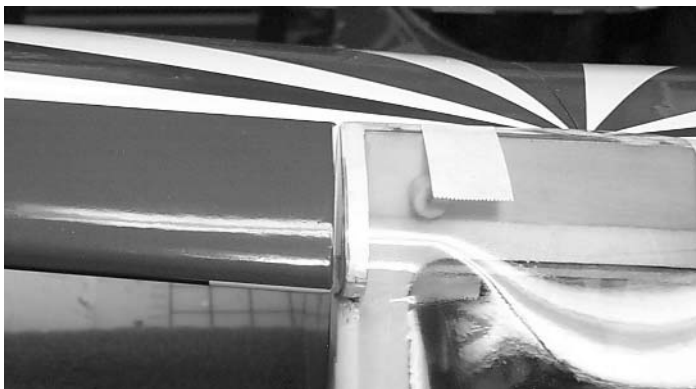

6.  Temporary place the Windshield back on the fuselage and mount the wing.
- Make sure the Windshield does not interfere with the wing mounting to the fuselage.

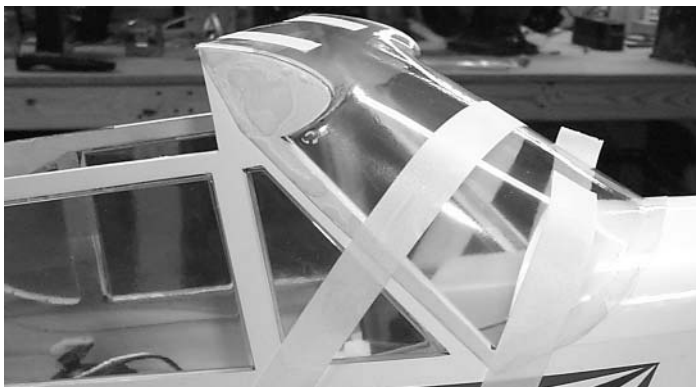

7.  Remove the wing and glue the Windshield to the fuselage.
- Use masking tape to hold the windshield in place till dry.

## WING STRUTS

1.  Collect the following items:
  - (1) Fuselage
  - (2) Wing Struts
  - (6) 2-56 Silver Clevis
  - (6) 2-56 Hex Nut
  - (6) Clevis Clips
  - (2) Aluminum Strut Bracket
  - (2) #2 x 5/16 Screw

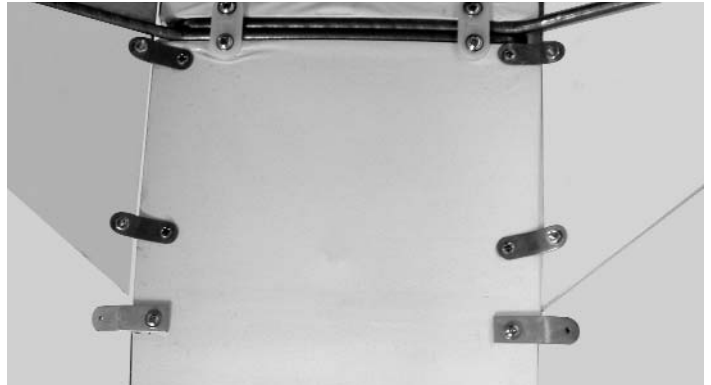

2.  Place the aluminum strut brackets just behind the landing gear fairings.
- Make a mark where the mounting holes are located.
- Drill 1/16" holes at the marks and mount the straps using the #2 x 5/16" screws.

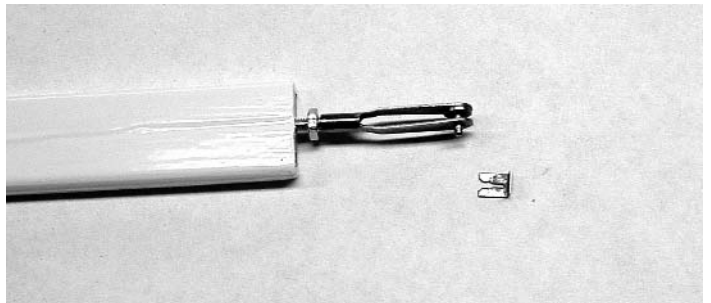

3.  On each end of the wing struts place a 2-56 hex nut, and a 2-56 Golden clevis.

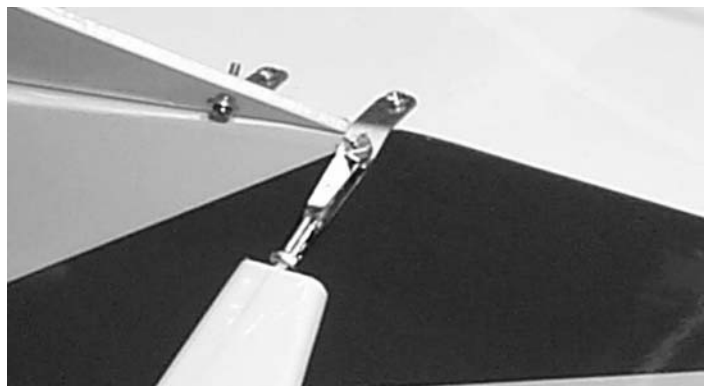

4.  Hook the bottom of the strut to the aluminum bracket on the bottom of the fuselage.

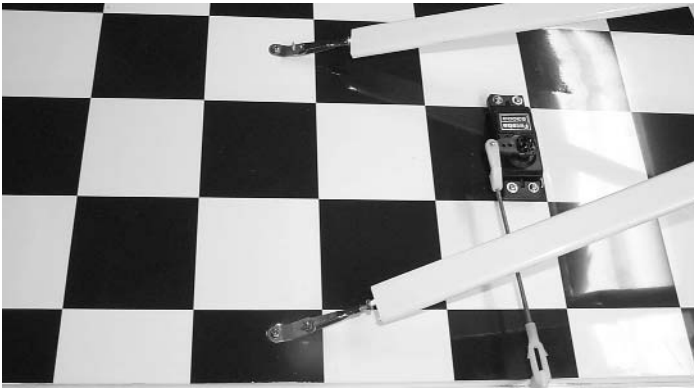

5.  Attach the wing to the strut by screwing the clevises in & out to the straps.

**Caution:**

**Tighten the wing struts just enough so that you do not have to “pull or tug” to put the struts on or off the wing and fuselage brackets.**

**Do not over tighten the struts they can distort the wing.**



3.  Drill a hole in the bottom of the fuselage and extend the receiver out to the tail.
  - Wrap the battery in foam and place it under or just behind the fuel tank. After checking the CG you can move the battery around to get the right balance.

**OPTIONAL FLYING WIRES**

WE RECOMMEND THAT YOU USE FLYING WIRES IF YOU WILL BE USING ANY ENGINE LARGER THAN A .70 2 STROKE OR .91 4 STROKE

**RECEIVER, BATTERY & SWITCH**



1.  Install your radio switch.



2.  Plug in your receiver. Make sure you wrap the receiver in foam.



1. Locate the following parts
  - Roll of braided cable
  - (8) metal brackets (2 with one larger holes)
  - (4) 2-56 rigging couplers
  - (4) golden clevis
  - (4) metal clevis retainers
  - (8) cable swages
  - (3) 2-56 x 1/2" screws
  - (3) 2-56 nuts
  - (3) #2 flat washers
  - (2) #2 x 1/2" sheet metal screws



2.  Take the 8 flat brackets and bend in the middle to about a 30 degree angle.
  - Use the three 2-56 x 1/2" screws with a washer under the head, and mount the brackets to the fin and stab with the aircraft nut on the bottom.

### Caution:

### Use thread lock on all bolts and nuts.



3.  The brackets go on each side of the fin and stab with one bolt holding two on. There is a predrilled hole at each location. Hold up to a light to help locate the hole under the covering.



4.  Measure forward 1" from the rudder hinge line.
  - Mount the other two brackets with the one larger hole to the bottom of the fuselage using the #2x1/2" sheet metal screws.

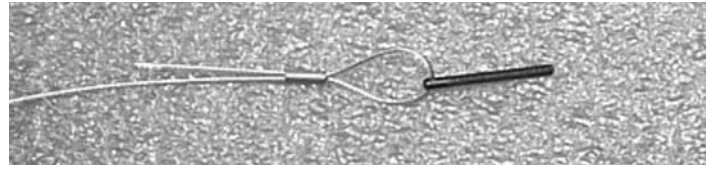

5.  Insert the cable through the 1/16 OD x 1/4" brass tubing.
  - Next thread the cable through the hole at the end of the 2-56 threaded rods and pass it back through the brass tube.

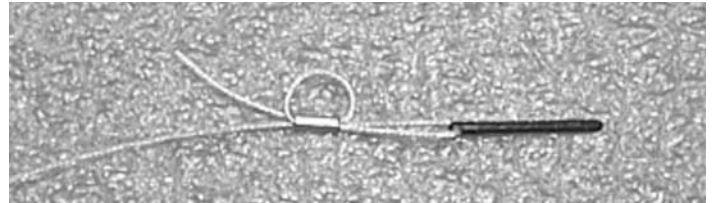

6.  Loop the end of the cable back through the brass tube.
  - Use pliers and crimp the brass tubing onto the cable to secure it.



7.  Screw a golden clevis on the rigging coupler and attach it to the bracket at the fin.
  - Pull the cable to the bracket on the stab and cut 2" past the hole.



8.  Pass the cable through the brass tube, through the bracket on the stab and back through the brass tube.
  - Pull the cable tight, but be careful not to put pressure on the stab or fin. We want the cable to just be snug at this point and we will adjust the tension after all four are in place.
  - Loop the cable back through the brass tube again and crimp.
  - Use pliers and crimp the brass tubing onto the cable to secure it.

8.  Pass the cable through the brass tube, through the bracket on the stab and back through the brass tube. Pull the cable tight, but be careful not to put pressure on the stab or fin. We want the cable to just be snug at this point and we will adjust the tension after all four are in place. Loop the cable back through the brass tube again and crimp.
- Repeat for the other four cables.
6.  After all four flying wires are in place, adjust the tension by disconnecting the clevis and turning.

**The wires should just be snug with no slop, don't distort the flying surfaces with too much tension.**



## DECAL APPLICATION

1.  Using glass cleaner and a soft cloth, clean the model surface thoroughly before applying decals.
2.  Cut the decal sheets apart in sections, as needed.
- Fold the decal in half, front to rear. Open at the fold and place the decal on a flat surface. The protective backing will bubble away from the decal at the fold.

We have given you small "N" numbers to be placed on the rudder or you can use the larger "N" numbers on the side of the fuselage if you choose.

If you choose to place the numbers on the side you will have to remove the black stripe where the number will rest. Remove the stripe by using an iron set to 300 deg. and gently pulling the stripe up. Once you have applied the number then you can reapply the stripe using heat.

## The Following is from the Carl Goldberg Products Anniversary Cub Booklet

### Setting Control Surfaces.

All pushrods must move freely, without binding; adjust if required for smooth operation. When setting control travel, be cautious that no servo is hooked to a control in a manner that prevents the servo wheel from moving through its complete range of rotation. For example, if the throttle servo "buzzes" when moved to "full-throttle" position, the servo still has movement left, but is jammed against the engine's full-throttle limit position. This can damage the servo and drain the battery, leading to loss of control, and a crash.

The following instructions describe how to set the control surfaces measuring up and down movement. A more precise measurement method is the use of the angle gauge described at the end of this section. Figures in parenthesis (see sketches) are the angular deflections for respective surfaces.

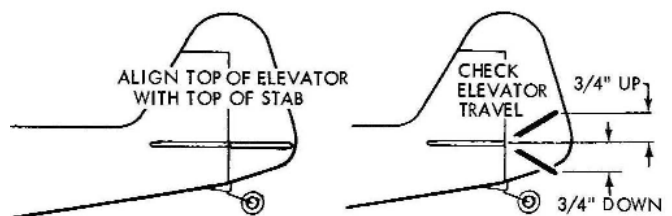

- With elevator trim tab on Tx set in center, adjust elevator mini-snap until top of elevator is flat with top of stab as shown above.
- Move the elevator stick on Tx full up and down. The elevator should move down about  $\frac{3}{4}$ " and up  $\frac{3}{4}$ ".

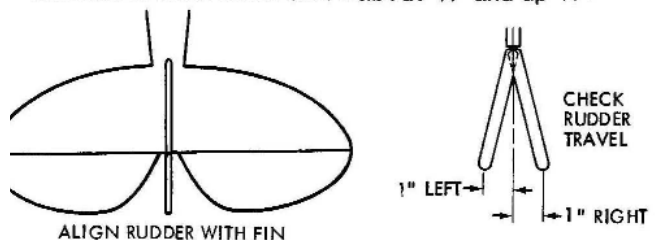

- With rudder trim tab on Tx set in center, adjust mini-snap until rudder aligns perfectly with fin. Tail wheel should point straight ahead.
- Move the rudder stick on Tx full right and left. The rudder should move to the right about 1" and left 1".
- Move throttle lever on Tx to cycle the throttle from idle to full power. Minor adjustments can be made by shifting the mini-snap location on the engine throttle arm.

- With aileron trim tab on Tx set in center, adjust mini-snaps until ailerons are flat with bottom of wing. Move the aileron stick full right and left. The ailerons should move respectively up about  $\frac{3}{8}$ " and down  $\frac{1}{4}$ " (slightly more up than down is desirable).

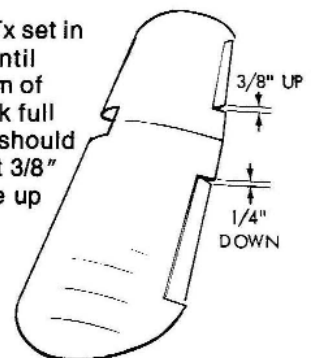

**THIS COMPLETES THE RADIO INSTALLATION**

# BALANCING AND CONTROL THROWS

## Throws

Use these control throws for the first flights. Work your way up to more throw movement when you are comfortable with the Cub ARF.

Elevator 3/4" UP & Down

Ailerons 3/8" Up & Down

Rudder 1" Right & Left

When you have gotten comfortable flying the Cub slowly increase the throws while still staying within your flying ability.

The Cub was designed around a .70 to .91 four-cycle engine these engines will give you excellent performance. Remember, a bigger engine is not always better.

## CG Balancing

Balancing the Cub is very important, you might need to use weight depending on the servos and engine that you use. Start out with the balance point between 3-3/4 to 4-1/4. This range of balance point is a safe place for you to fly the Cub. As you get comfortable you can move the CG back further. The further you move the CG the more wild the aerobatics will become, **BUT** the more unstable the Cub will also become.

## PRE-FLIGHT & BASIC AEROBATICS

The following is presented as a pre-flight review for safe and enjoyable flying. If you have been flying only tricycle gear models, you should have little, if any problem getting used to take offs and landings with a tail wheel. For take off, remember to feed in right rudder as required to keep the model rolling straight ahead. Very little right rudder is needed.

If you have never successfully flown an R/C model before, do not try to teach yourself to fly this higher performance model.

## VIII RADIO CHECK

Before going to the field to fly, with batteries fully charged, turn on receiver and transmitter and actuate all controls many times until you are satisfied with all functions. Stand behind the model, and make sure that the control responses are correct. Move the control stick to the right and the right aileron should go up. Moving the stick back or down on the Tx should move the elevator up, and vice versa.

Check also to see that your tail wheel turns to the right when you give right rudder. Your throttle should open to permit full power when the stick is moved forward or up. Make sure that everything is neatly and firmly in place—engine fastened down, servos snugged down, receiver and battery wrapped in foam rubber, tank properly supported, etc. Prop must be tight. Nothing should be loose, or unfinished, or unchecked. Receiver antenna must be extended, not coiled up inside the model.

Prior to the beginning of each day's flying, make a range check of your equipment in accordance with the manufacturer's instructions. In general, with transmitter antenna collapsed to 6" to 8", you should have at least 100 feet range on the ground. To check this, turn on both the transmitter and receiver switches, set the model heading away from you, and walk away while transmitting signals. Watch to see that no signals are missed until you are at least 100 feet away. Only if the equipment works perfectly should any flights be attempted. **Be careful not to use your transmitter** when someone else on the field is flying or testing on the same frequency.

## AEROBATICS

We highly recommend the book **Flight Training Course, Volume II**, published by **R/C Modeler Magazine**, a small portion of which they have graciously permitted us to reprint here.

On your previous R/C plane, you probably have already tried some of the maneuvers shown here. We present them as an introduction and review of a rewarding aspect of R/C flying—carefully planned and executed flying technique. It's something even expert pattern flyers must practice diligently. An apparently simple thing such as "Touch and Goes," and flying a tight, well-defined traffic pattern are really basic to performing accurate and precise advanced maneuvers.

"Touch and Goes" are an exercise in approach planning, airspeed control, and smooth use of the throttle. These are important

## VII WHERE TO FLY YOUR MODEL

Fly only in areas sanctioned for R/C and known to be free of radio interference. If you don't know the whereabouts of an R/C club near you, write the Academy of Model Aeronautics (AMA) and ask if they have a club on file in your area. Most clubs are chartered with the AMA, and we recommend you become a member.

With everything ready, the engine should be started and broken in for at least a tank or two at no more than moderate speed. While the engine is running, the control surfaces should not jitter or move until you command them. The throttle also should respond to your command.

### CHECK STEERING THE MODEL ON THE GROUND

Apply minimum throttle so that it just keeps the model moving at a walking pace. With rudder stick and rudder trim in neutral position, the model should move straight ahead. If it constantly turns left or right, the tail wheel is not pointing straight ahead, and should be adjusted until it is correct. After taxi runs are completed, thoroughly examine the model, and tighten loose screws, etc.

## PRE-FLIGHT CHECK LIST, THINGS TO DO, AND THINGS TO TAKE TO THE FIELD

- Flight batteries fully charged
- Radio transmitter (DON'T LEAVE IT AT HOME!)
- Fresh 1-1/2 volt starting battery & Glo plug clip
- Tools to tighten anything that can vibrate loose
- Fuel and fuel bulb or pump
- Paper toweling (for clean up)
- SUPER JET
- Extra props
- Prop wrench

elements for all advanced maneuvers. And they will be flown only as crisp and graceful as you want them to be since "practice does make perfect!"

"Which Side is Up?" The business about learning to recognize which side is up may sound foolish, but many a plane has bitten the dust because the pilot thought it was flying one way and it was going another. Other than learning to recognize the plane's silhouette at different angles and attitudes, the best insurance is to learn to keep your head on what you're doing. That is, force yourself to remember where you've come from as well as where you're going. For example, if you concentrate on the fact that you're making a left turn, you'll probably never mix up that silhouette in the sky. If you look away though or forget what the plane is doing, coming back to it can cause a few new grey hairs!

## TOUCH AND GOES

In doing a Touch and Go you'll be putting three things together that you've already worked on: the final leg of the Traffic Pattern Approach, the Landing Perfection, and the Takeoff. The only thing that's added is making the transition from the touchdown to the takeoff while the plane is still rolling. And, you have to be able to put your plane down on the runway with enough room left over for a smooth takeoff and gradual climb out.

### What The Touch And Go Looks Like.

The plane is flying at about 25-feet altitude at about 200 feet from the end of the runway flying into the wind. The engine is either running at an idle or nearly so with the plane sinking gradually toward the runway in a slightly nose-down attitude. When the plane reaches about 6-feet altitude, the glide path levels off in preparation for the flare out and final touchdown.

When the plane touches down, it slows down to approximately  $\frac{1}{4}$  the flight speed. Without stopping the plane begins accelerating and lifts off. The lift off and climbout is gradual and smooth.

PLANE THROTTLED DOWN HOLDING SOME UP ELEVATOR FOR DESCENT

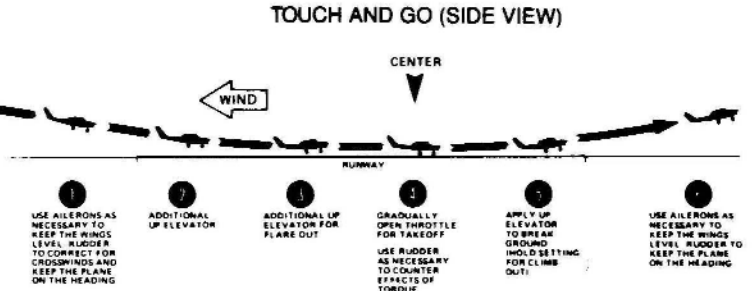

## THE LOOP

This is a good one to start with because it's usually the first "stunt" the new pilot has the guts to try. Another reason is that, at first glance, there seems to be nothing to it.

### What The Maneuver Looks Like.

The model starts the maneuver flying straight and level into the wind. Then it pulls up into a smooth, round loop. The up and down portions should be straight up and down with reference to the ground. That is, the plane shouldn't fall off to the left or right. The speed of the plane should be constant throughout the loop.

As the plane finishes the loop, it should pull out in a straight and level flight at the same heading and altitude as it entered the loop and fly off for 50 feet.

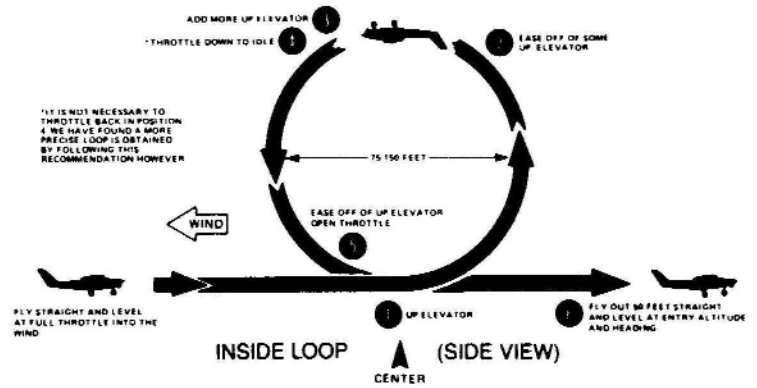

## THE STALL TURN

Getting the plane in a vertical climb and applying rudder at the proper time is what the Stall Turn is all about. Too soon, and you'll only wag your tail. Too late, and it won't do any good — the plane will just stall out and fall off. So, to get the Stall Turn to happen as it should, you have to be able to get the vertical climb vertical. Recognize that second or two just before the plane stalls out — while there is still enough air moving over the rudder and apply the rudder. That gets the tail moving so it will continue to coast around while the plane stalls out.

### What The Stall Turn Looks Like

The Stall turn, or hammerhead, is one of those smooth, pretty maneuvers. Flying straight and level, past center about 100 feet, the plane pulls up sharply into a vertical climb. As it climbs, the engine idles down and the plane begins to slow down as if it has run out of gas. When it looks as though there's no more oomph left, the plane pivots 180° on its left or right wing tip and heads straight down. Under control all the way.

When the plane gets to the entry altitude, it pulls out, heading in a direction opposite the entry and levels off. The throttle opens up and the plane flies off. Neat.

