

# Shoestring 15e ARF

Assembly Manual



**E-flite**<sup>®</sup>  
ADVANCING ELECTRIC FLIGHT

## Notice

All instructions, warranties and other collateral documents are subject to change at the sole discretion of Horizon Hobby, Inc. For up-to-date product literature, visit <http://www.horizonhobby.com> and click on the support tab for this product.

## Meaning of Special Language

The following terms are used throughout the product literature to indicate various levels of potential harm when operating this product:

**NOTICE:** Procedures, which if not properly followed, create a possibility of physical property damage AND a little or no possibility of injury.

**CAUTION:** Procedures, which if not properly followed, create the probability of physical property damage AND a possibility of serious injury.

**WARNING:** Procedures, which if not properly followed, create the probability of property damage, collateral damage, and serious injury OR create a high probability of superficial injury.

 **WARNING:** Read the ENTIRE instruction manual to become familiar with the features of the product before operating. Failure to operate the product correctly can result in damage to the product, personal property and cause serious injury.

This is a sophisticated hobby product and NOT a toy. It must be operated with caution and common sense and requires some basic mechanical ability. Failure to operate this Product in a safe and responsible manner could result in injury or damage to the product or other property. This product is not intended for use by children without direct adult supervision. Do not attempt disassembly, use with incompatible components or augment product in any way without the approval of Horizon Hobby, Inc. This manual contains instructions for safety, operation and maintenance. It is essential to read and follow all the instructions and warnings in the manual, prior to assembly, setup or use, in order to operate correctly and avoid damage or serious injury.

## Warnings

Read and follow all instructions and safety precautions before use. Improper use can result in fire, serious injury and damage to property.

**Age Recommendation: Not for children under 14 years. This is not a toy.**

## COMPONENTS

Use only with compatible components. Should any compatibility questions exist, please refer to the product instructions, the component instructions or contact Horizon Hobby, Inc.

## FLIGHT

Fly only in open areas to ensure safety. It is recommended flying be done at AMA (Academy of Model Aeronautics) approved flying sites. Consult local laws and ordinances before choosing a location to fly your aircraft.

## PROPELLER

Keep loose items that can get entangled in the propeller away from the prop, including loose clothing or other objects such as pencils and screwdrivers. Especially keep your hands away from the propeller as injury can occur.

## BATTERIES

### Notes on Lithium Polymer Batteries

When misused, lithium polymer batteries are significantly more volatile than alkaline or Ni-Cd/ Ni-MH batteries used in RC applications. Always follow the manufacturer's instructions when using and disposing of any batteries. Mishandling of Li-Po batteries can result in fire causing serious injury and damage.

## SMALL PARTS

This kit includes small parts and should not be left unattended near children as choking and serious injury could result.

## SAFETY PRECAUTIONS

- Check all control surfaces prior to each takeoff.
- Do not fly your model near spectators, parking areas or any other area that could result in injury to people or damage of property.
- Do not fly during adverse weather conditions. Poor visibility and/or strong winds can cause disorientation and loss of control of your aircraft.
- Do not take chances. If at any time during flight you observe any erratic or abnormal operation, land immediately and do not resume flight until the cause of the problem has been ascertained and corrected. Safety can never be taken lightly.
- Do not fly near power lines.

## Table of Contents

Notice .....	2
Meaning of Special Language .....	2
Warnings .....	2
Introduction .....	3
Important Information Regarding Warranty Information	3
Specifications .....	3
Using the Manual .....	3
Contents of Kit/Parts Layout .....	4
Covering Colors .....	4
Before Starting Assembly .....	4
Hardware/Accessory Sizes .....	4
Recommended Radio Equipment .....	4
Recommended Sport Setup .....	4
Recommended Racing Setup .....	4
Optional Accessories .....	4
Required Tools and Adhesives .....	4
Landing Gear Installation .....	5
Hinging the Ailerons .....	7
Installing the Aileron Servos .....	8
Hinging the Elevators .....	10
Wing and Stabilizer Installation .....	13
Rudder and Fin Installation .....	15
Servo and Receiver Installation .....	17
Motor and Speed Control Installation .....	19
Cowling Installation .....	21
Decal Installation .....	23
Center of Gravity .....	24
Control Throws .....	24
Preflight .....	25
Range Test Your Radio .....	25
Flying Your Model .....	26
Daily Flight Checks .....	27
Limited Warranty .....	27
Warranty Services .....	28
Compliance Information for the European Union .....	28
Academy of Model Aeronautics National Model Aircraft Safety Code .....	29

## Introduction

Congratulations on buying the Shoestring 15e. You have purchased what is arguably one of the most fun airplanes in the marketplace today. Originally designed as a fast sport flyer to bring an adrenaline rush to mid- to advanced-level pilots, the project quickly advanced to an even greater purpose. Working with legendary designers Dan Kane and Jerry Small, we developed the airplane into the standard for the upcoming Electric Formula One racing class from the NMPRA (National Miniature Pylon Racing Association).

We have designed a unique cowl system that includes all the graceful curves of the front of the fuselage into one piece that stretches back to the mid canopy point. This allows for very easy maintenance, easy mounting of equipment, and great cooling for the EP power system. We also elected to use mini servos throughout to save weight and expense.

Power for your airplane can be anything from our Power 15 motor on a 3S setup and 10 x 10E prop (prop clearance limits anything longer) to a full blown race setup with our new Power 25 1250Kv on 4S and an 8 x 8E prop turning about 15,000 rpm. The sport setup will put you in the 80 mph range while the race setup has been clocked at about 115 mph.

The airplane is a smooth flyer and goes exactly where you point it. Make sure all your friends pick up one of these kits, then challenge each other to some impromptu racing for bragging rights at your local field. You'll have a blast!

## Important Information Regarding Warranty Information

Please read our Warranty and Liability Limitations section before building this product. If you as the Purchaser or user are not prepared to accept the liability associated with the use of this Product, you are advised to return this Product immediately in new and unused condition to the place of purchase.

### Specifications

Wingspan:	50.5 in (128cm)
Length:	38.3 in (97.3cm)
Wing Area:	375 sq in (24.2 sq dm)
Weight with battery:	3.4–3.5 lb (1.55–1.70 kg)
Weight w/o battery:	2.8–3.1 lb (1.25–1.40 kg)

### Using the Manual

This manual is divided into sections to help make assembly easier to understand and to provide breaks between each major section. In addition, check boxes have been placed next to each step to keep track of its completion. Steps with a single circle (○) are performed once, while steps with two or more circles (○○) indicate the step will require repeating, such as for a right or left wing panel, two servos, etc.

Remember to take your time and follow the directions.

## Contents of Kit/Parts Layout

### Replacement Parts

EFL420501	Fuselage with Hatch
EFL420502	Main Wing Set with Ailerons
EFL420503	Tail Set
EFL420504	Landing Gear with Axle
EFL420505	Wheel pants set (painted)
EFL420506	EP Standoff set (8pcs)
EFL420507	Cowl (painted)
EFL420508	Wing tube
EFL420509	Fuselage hatch
EFL420510	Hardware Bag
EFL420511	Landing Gear with Axles
EFL420512	Wing Mounting Clips



### Covering Colors

Midnight Blue	HANU885
Sky Blue	HANU875
Bright Yellow	HANU872

### Hardware/Accessory Sizes

Main wheel	2-inch (52mm)
Tail wheel	1/2-inch (13mm)

## Before Starting Assembly

Before beginning the assembly of your model, remove each part from its bag for inspection. Closely inspect the fuselage, wing panels, rudder and stabilizer for damage. If you find any damaged or missing parts, contact the place of purchase.

If you find any wrinkles in the covering, use a heat gun (HAN100) and covering glove (HAN150) or covering iron (HAN101) with a sealing iron sock (HAN141) to remove them. Use caution while working around seams or areas where the colors overlap to prevent pulling the seams.

### Recommended Radio Equipment

You will need a minimum 4-channel transmitter, receiver and four servos.

#### Recommended Transmitter

SPMR5510	DX5e DSMX® 5-Channel Transmitter Only
----------	---------------------------------------

#### Additional Items

SPMAR7010	AR7010 7-Channel DSMX Receiver
SPMSA5030	Mini Digital Aircraft Servo (2)
JRPS388	Digital Micro Metal Gear Servo (2)
SPMA3001	6-inch (152mm) Servo Extension (2)

### Recommended Sport Setup

Motor:	Power 15 Brushless 975Kv Outrunner (EFLM4015A)
Speed Control:	40A Pro Switch-Mode BEC BL ESC (EFLA1040)
Battery:	3200mAh 3S 11.1V 30C Li-Po Battery (EFLB32003S30)
Spinner:	1.5-inch Aluminum Bullet Spinner (EFLSP150B)
Propeller:	10 x 10E (APC10010E)

## Recommended Racing Setup

Motor:	Power 25 BL 1250Kv Outrunner (EFLM4025B)
Speed Control:	60A Pro Switch-Mode BEC BL ESC (EFLA1060)
Battery:	4S 14.4V 30C Li-Po Battery (EFLB25004S30)
Spinner:	1.5-inch Aluminum Bullet Spinner (EFLSP150B)
Propeller:	8 x 8E (APC08080E)

### Optional Accessories

EFLA110	Power Meter
EFLC3025	Celestra™ 80W AC/DC Multi-Chemistry Battery Charger

## Required Tools and Adhesives

### Tools & Equipment

Drill	Epoxy brush
Felt-tipped pen	Flat blade screwdriver
Low-tack tape	Light machine oil
Long nose pliers	Mixing cup
Mixing sticks	Needle nose pliers
Paper towels	Pencil
Pin vise	Phillips screwdriver: #1, #2
Rubbing alcohol	Ruler
Sandpaper	T-pins
Side cutter	Square
Straight edge	Toothpicks
Balancing stand (optional)	
Open end or box wrench: 10mm, 13mm	
Hook and loop strap (EFLH1444)	
Hook and loop tape (DUB348)	
Hobby knife with #11 blade	
Hex wrench or ball driver: 2.5mm, 3/32-inch, 3mm	
Drill bit: 1/32-inch (1mm), 1/16-inch (1.5mm), 5/64-inch (2mm), 1/8-inch (3mm), 5/32-inch (4mm)	

### Adhesives

Medium CA	PAAPT02
Thin CA	PAAPT08
Threadlock	PAAPT42
30-minute epoxy	PAAPT39
Plastic Tape, Clear, 3/4 x 125-inch	MMM190CL

## ***Etips***

During the course of building your model, we suggest you use a soft base for the building surface.

Such things as a foam stand, large piece of bedding foam or a thick bath towel will work well and help protect the model from damage during assembly. This is not shown in the instructions to provide the greatest detail in the photos.

## ***Etips***

When referencing directions (up, down, left, right, top and bottom), take note that these are in relationship to the pilot sitting in the cockpit of the aircraft unless noted otherwise.

## ***Etips***

Before starting the assembly of your model, we recommend preparing your radio system for installation. This includes charging the transmitter and receiver batteries, as well as centering the trims and sticks on your transmitter. If using a computer radio, make sure to reset a model memory and name it for this particular model. We also recommend binding the transmitter and receiver at this time, following the instructions provided with your radio system.

→ We highly recommend re-binding the radio system once all the control throws are set. This will keep the servos from moving to their endpoints until the transmitter and receiver connect.

## ***Landing Gear Installation***

### **Required Parts**

Fuselage  
Wheel pant (right and left)  
Landing gear fairing (left and right)  
Main wheel (2)  
Axle with hardware (2)  
Aluminum landing gear

### **Located with Fuseage**

4mm washer (2)  
4mm lock washer (2)  
4mm x 15mm socket head bolt (2)

### **Required Tools and Adhesives**

Felt-tipped pen  
Light machine oil  
Threadlock  
Hobby scissors  
Open-end wrench: 10mm  
Hex wrench or ball driver: 2.5mm, 3mm  
Drill  
Drill bit: 5/32-inch (4mm)  
Flat blade screwdriver  
Hobby knife with #11 blade

## ***Etips***

Always use threadlock on metal-to-metal fasteners to prevent them from vibrating loose.

- 1. Secure the landing gear to the bottom of the aircraft using two 4mm x 15mm socket head bolts, two 4mm washers and two 4mm lock washers. The straight side of the gear faces to the front of the aircraft. Use a 3mm hex wrench or ball driver to tighten the bolts.



- 2. Use hobby scissors and a hobby knife with a #11 blade to trim the landing gear fairings. Leave the size of the fairings slightly over-sized.



- 3. Fit the landing gear fairings over the gear. Slowly trim the fairings to fit to the fuselage. When installed, they will cover the area where the landing gear attaches to the fuselage. Use clear tape to secure the fairings to the fuselage.

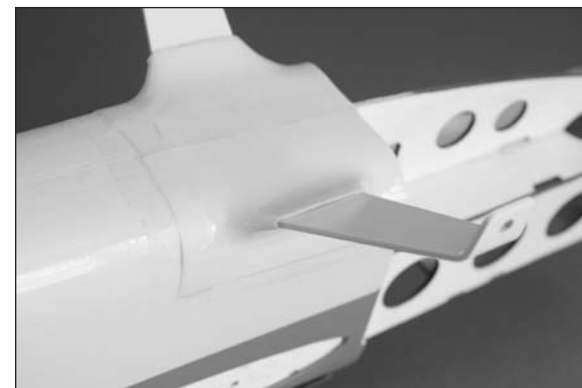

- 4. Remove the hardware from the axle. Place a drop of light machine oil on the axle to help the wheel roll freely.

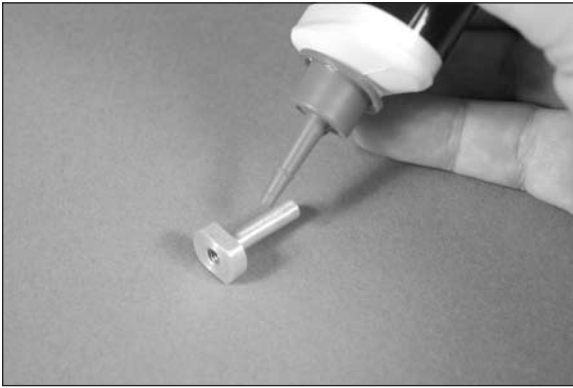

- 5. Slide the axle into the wheel.

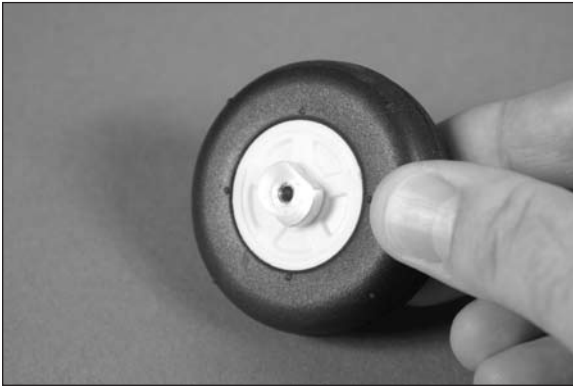

***E-tips***

Always use threadlock on metal-to-metal fasteners to prevent them from vibrating loose.

- 6. Use a 2.5mm hex wrench or ball driver to secure the wheel using the shorter 4mm x 5mm button head screw and 4mm washer removed from the axle.



- 7. Slide the wheel into the wheel pant. You may need to flex the pant open slightly to get the wheel to fit.



- 8. Use the longer 4mm x 12mm button head screw and 4mm washer to secure the wheel and wheel pant to the landing gear. Use a 2.5mm hex wrench or ball driver to tighten the screw. Use a 10mm open-end wrench to hold the axle while tightening the screw.



- 9. Repeat Steps 4 through 8 to install the remaining wheel and wheel pant on the landing gear.



## Hinging the Ailerons

### Required Parts

Left wing panel with aileron  
Right wing panel with aileron

### Required Tools and Adhesives

T-pin  
Pin vise  
Thin CA  
Drill bit: 1/16-inch (1.5mm)

- 1. Remove the aileron and hinges from the wing panel. Use a pin vise and 1/16-inch (1.5mm) drill bit to drill a hole in the center of each hinge slot. Drill holes in both the aileron and wing. This creates a tunnel for the CA to wick into, making a better bond between the hinge and surrounding wood.

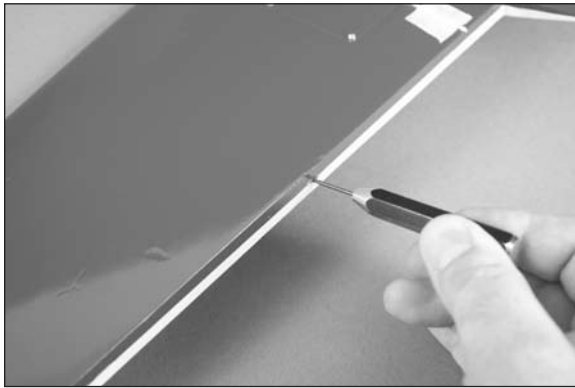

- 2. Place a T-pin in the center of each of the three hinges. This will center the hinges when installed in the aileron.

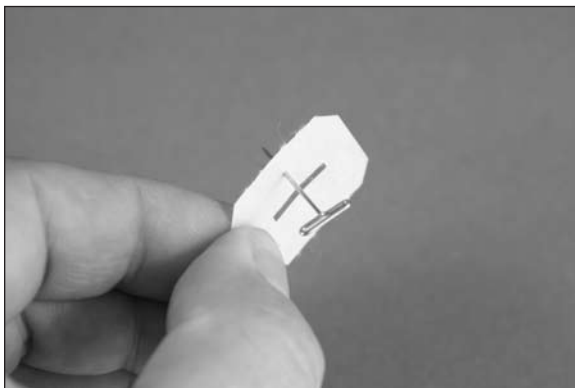

- 3. Place the hinges in the aileron as shown.

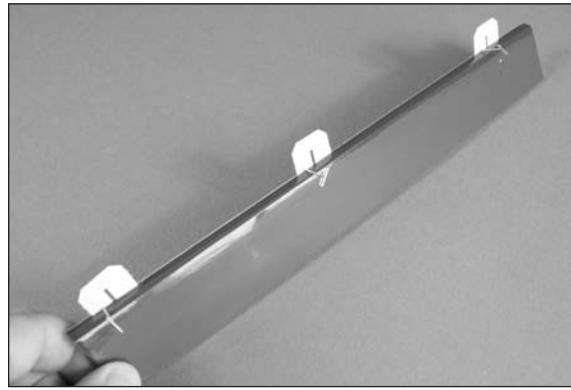

- 4. Slide the aileron back into position.

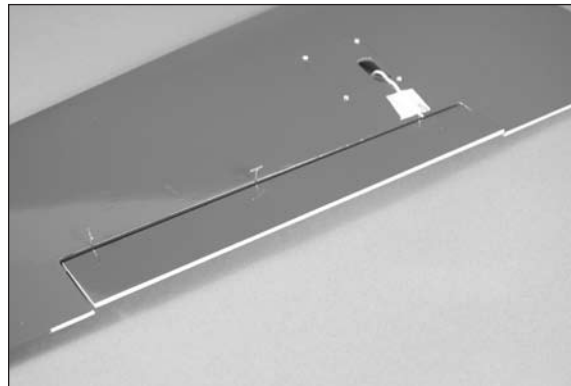

**Etips**

When gluing the hinges, do not use CA accelerator. The CA must be allowed to soak into the hinge to provide the best bond between the hinge and surrounding wood.

- 5. Remove the T-pins, then press the aileron tightly against the wing. Center the aileron in the opening and check that it can move freely without binding at the root or tip. Wick thin CA into the top and bottom of all three hinges.

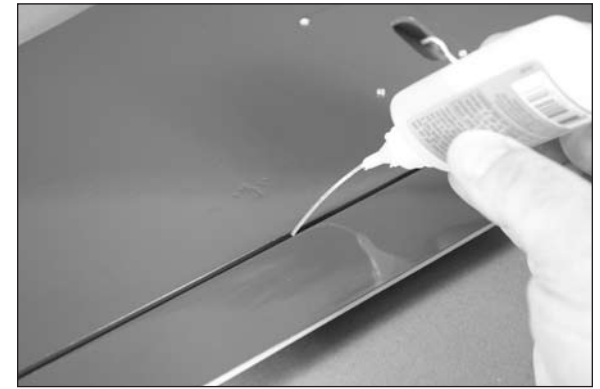

- 6. Once the CA has fully cured. Gently pull on the aileron to make sure the hinges are secure. If any hinges are loose, reapply CA to the hinge. Flex the aileron through its range of motion a number of times to break in the aileron hinges.

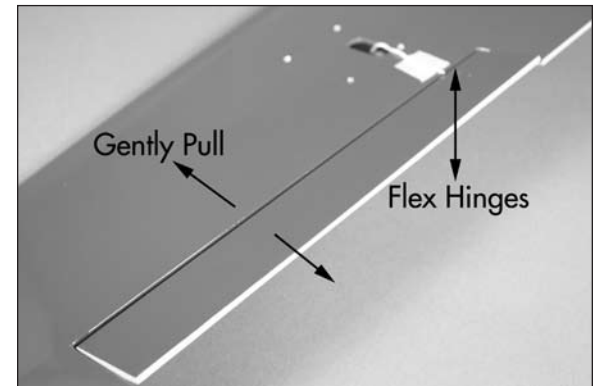

- 7. Repeat Steps 1 through 7 to hinge the remaining aileron.

## Installing the Aileron Servos

### Required Parts

Wing panel (right and left)  
Transmitter                      Receiver  
Control horn (2)      Receiver battery  
Thin wing servos with hardware (2)  
Metal clevis (2)  
2-inch (52mm) linkage with 2mm nut (2)  
2mm x 12mm sheet metal screw (4)  
Control horn backplate (2)  
6-inch (152mm) servo extension (2)

### Required Tools and Adhesives

Side cutter                      Phillips screwdriver: #1  
Thin CA                      String or dental floss  
Pin vise  
Drill bit: 1/16-inch (1.5mm), 5/64-inch (2mm)

- 1. Remove the servo cover from the wing by removing the four 2mm x 12mm sheet metal screws using a #1 Phillips screwdriver. Do not let the string fall into the wing as it is used to pull the servo lead through the wing.

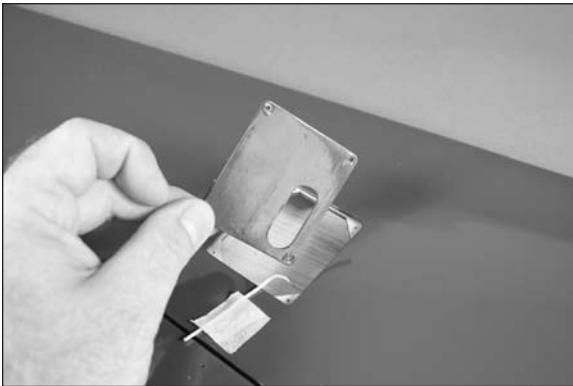

- 2. Install the rubber grommets and brass eyelets in the servo. Place the servo between the tabs on the servo cover with the output of the servo over the opening in the cover. With the servo spaced slightly off the cover, use a pencil to mark the location for the servo mounting screws.



- 3. Use a pin vise and 1/16-inch (1.5mm) drill bit to drill the holes for the servo mounting screws.

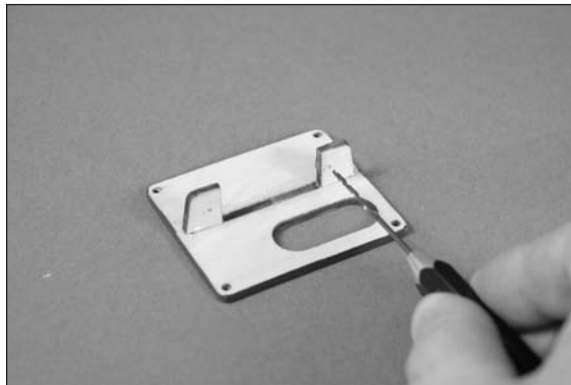

- 4. Use a #1 Phillips screwdriver to thread a servo mounting screw into each of the holes to cut threads in the surrounding wood. Remove the screw before moving to the next step.

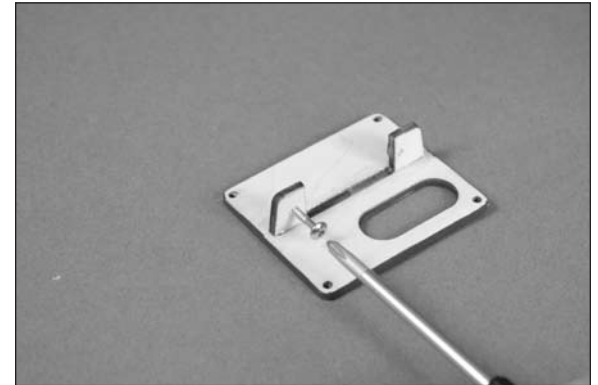

- 5. Apply 2-3 drops of thin CA in each of the holes to harden the surrounding wood. This will harden the threads so the screws do not easily strip the surrounding wood.





- 6. Secure the servo using the screws provided with the servo and a #1 Phillips screwdriver. The output shaft of the servo will align with the opening in the cover. Center the aileron servo using the radio system.

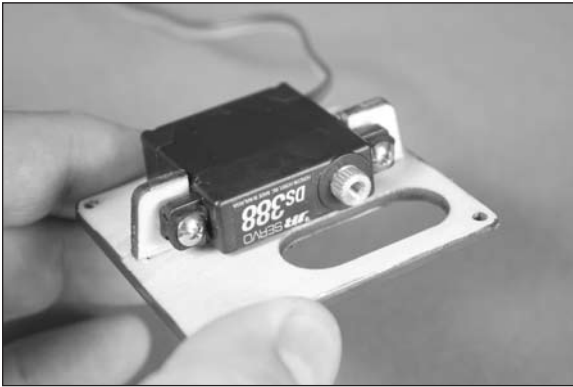

- 7. Use a pin vise and 5/64-inch (2mm) drill bit to enlarge the hole in the servo arm 1/2 inch (13mm) from the center of the servo horn. Remove the arms from the servo horn that will not be used using side cutters.

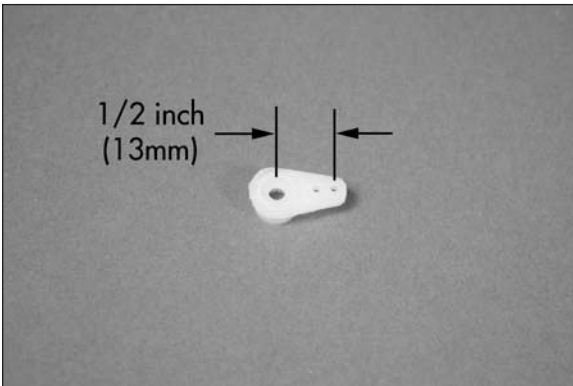

- 8. Fit the servo horn to the servo so it is perpendicular to the servo. Use side cutters to remove the arms that do not protrude through the cover.



- 9. Use string or dental floss to secure a 6-inch (152mm) servo extension to the aileron servo lead.

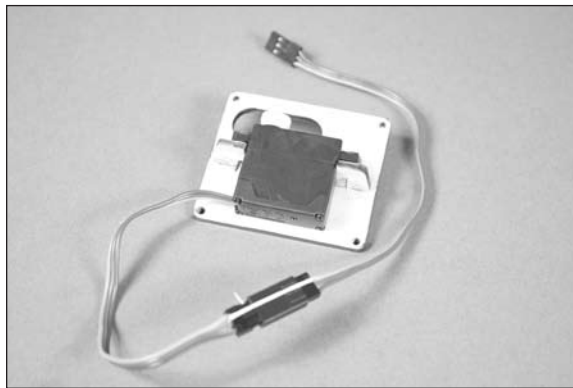

- 10. Tie the string around the extension. Use the string to pull the extension through the wing root.



- 11. Apply 1–2 drops of thin CA in each of the holes to harden the surrounding wood for the aileron cover screws.

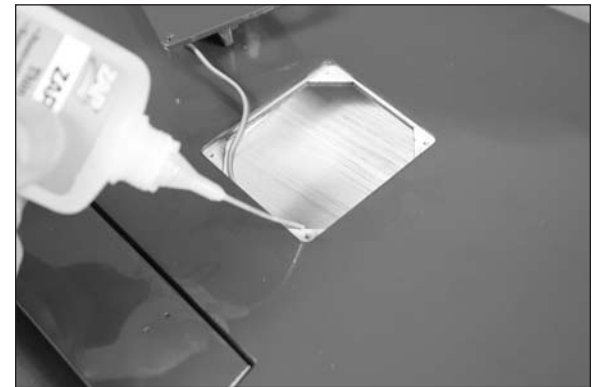

- ○ 12. Secure the aileron servo cover using the four 2mm x 12mm sheet metal screws remove in step 1 and a #1 Phillips screwdriver.

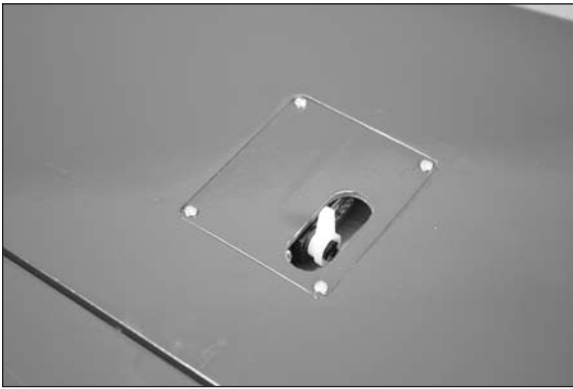

- ○ 13. Use a pin vise and 5/64-inch (2mm) drill bit to drill the two holes completely through the aileron for the aileron control horn mounting screws. The holes have already been started and are easily found on the bottom of the aileron

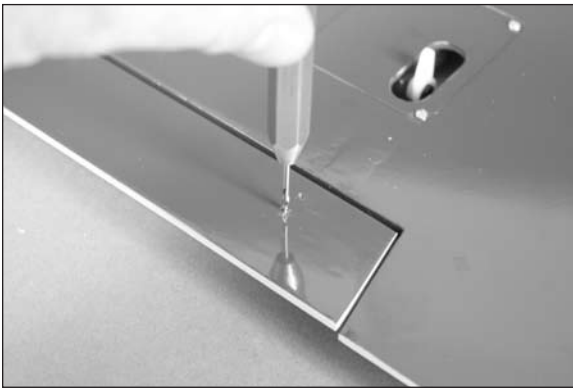

- ○ 14. Attach the control horn to the aileron using two 2mm x 12mm sheet metal screws and a control horn backplate. Use a #1 Phillips screwdriver to tighten the screws.

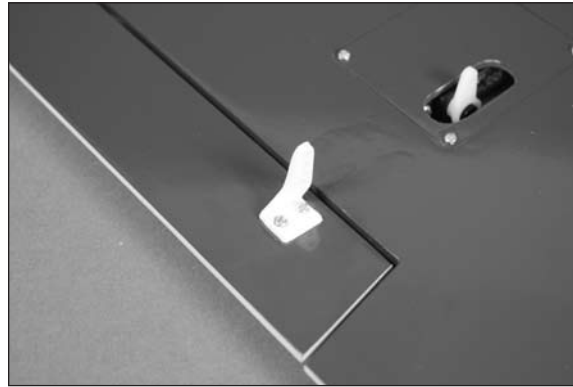

- ○ 15. With the aileron servo centered, attach the Z-bend of the 2-inch (52mm) pushrod to the aileron servo horn. Thread a clevis on the pushrod. Adjust the clevis so when it is attached to the control horn the aileron is centered. Tighten the 2mm nut against the clevis using needle nose pliers to prevent the clevis from vibrating loose.

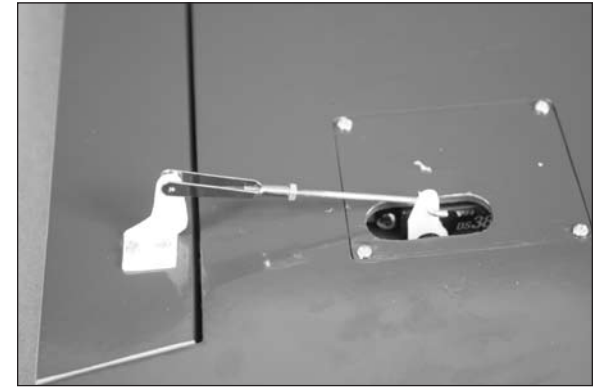

- 16. Repeat steps 1 through 15 to install the remaining aileron servo and linkage.

## Hinging the Elevators

### Required Parts

Stabilizer and elevator assembly

### Required Tools and Adhesives

Pin vise	Drill bit: 1/16-inch (1.5mm)
Sandpaper	Toothpicks
30-minute epoxy	Low-tack tape
Square	Felt-tipped pen
Thin CA	T-pins
Mixing cups	Mixing sticks
Paper towels	Rubbing alcohol
Ruler or straightedge	

→ The top of the elevator and stabilizer are shown in this section of the manual.

- 1. Remove the stabilizers from the elevator. Also, remove the elevator joiner connecting the elevators.

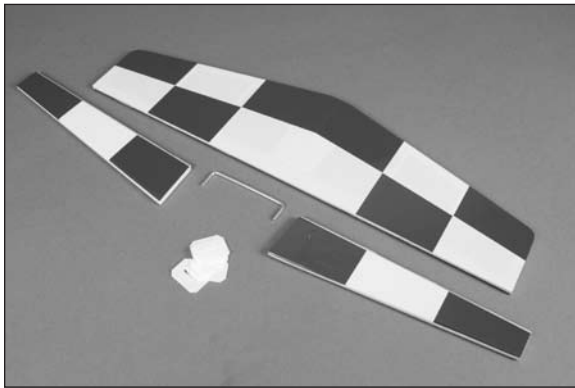

- 2. Use a pin vise and 1/16-inch (1.5mm) drill bit to drill a hole in the center of each hinge slot. Drill holes in both the elevators and stabilizer. This creates a tunnel for the CA to wick into, making a better bond between the hinge and surrounding wood.

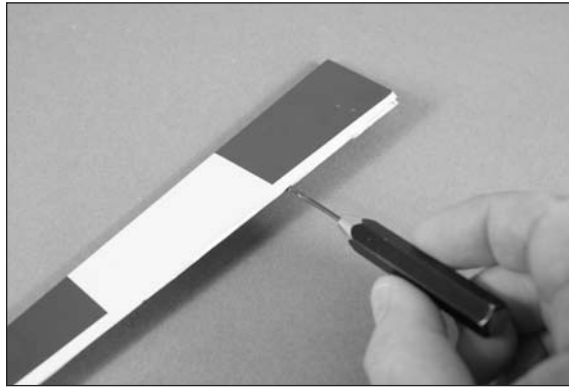

- 3. Use sandpaper to roughen the ends of the joiner wire. This provides a surface for the epoxy to bond to when the joiner is installed.

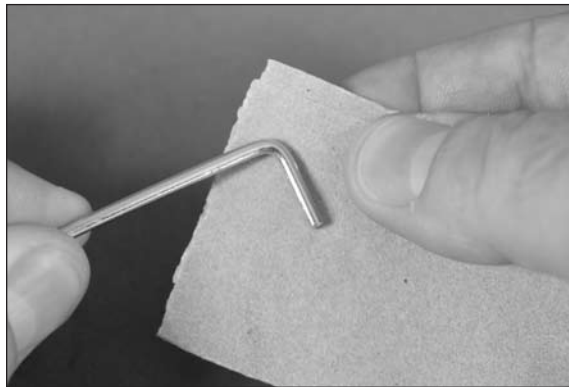

- 4. Mix a small amount of epoxy. Use a toothpick to apply the epoxy to the joiner where it contacts the elevators.

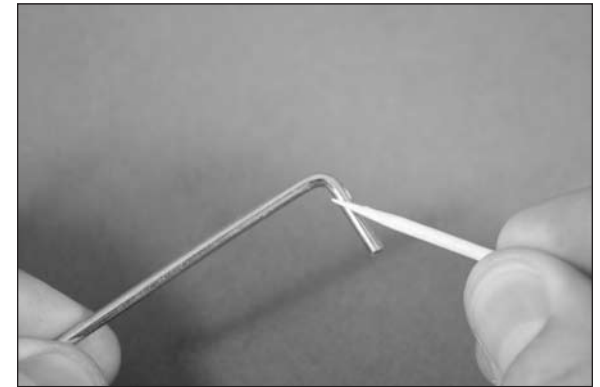

- 5. Use a toothpick to apply epoxy into the hole for the joiner wire and the exposed wood where the joiner wire fits in the elevators.

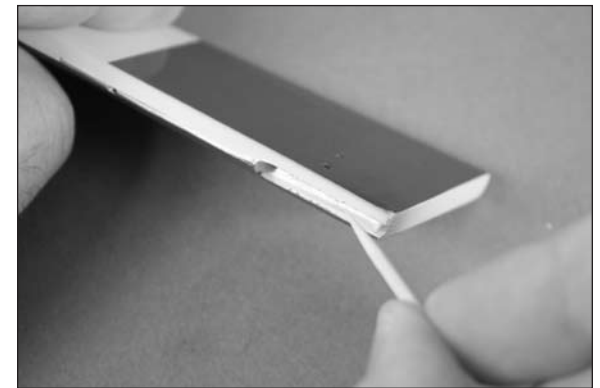

***Etips***

Steps 6 through 13 can be performed while the epoxy is curing on the joiner wire.

- 6. Insert the joiner wire into both elevator halves. Use low-tack tape to keep the joiner wire in position while the epoxy cures. Use a straight edge to make sure the elevator halves are in alignment with each other. Also make sure the elevator halves lay flat on your work surface.

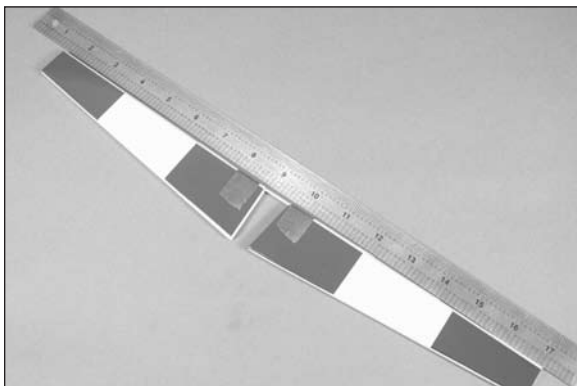

- 7. Use a ruler to determine the center of the stabilizer. Use a square and felt-tipped pen to mark the center line on the top of the stabilizer. This will help in aligning the stabilizer on the fuselage later.

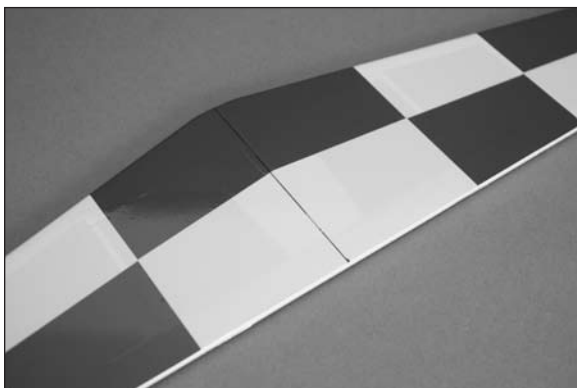

- 8. Place a T-pin in the center of each of the six hinges. This will center the hinges when installed in the stabilizer.

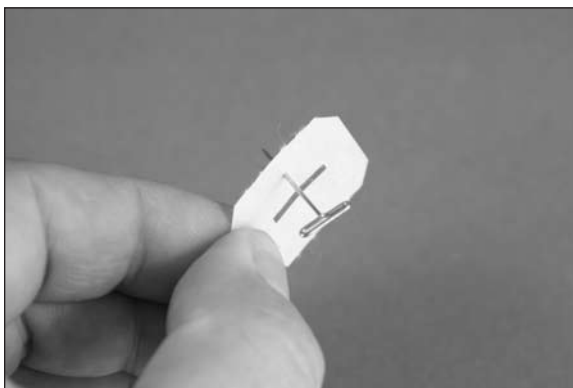

- 9. Place the hinges in the stabilizer as shown.

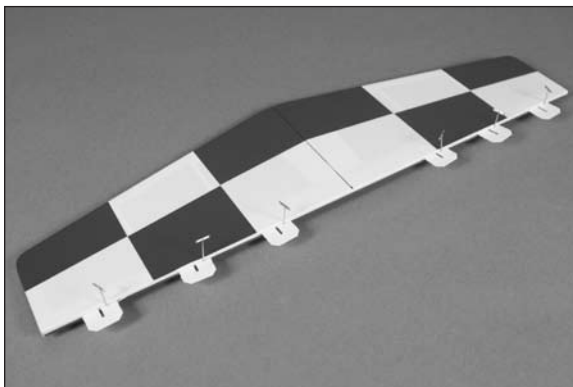

- 10. Slide the elevators in position on the stabilizer.

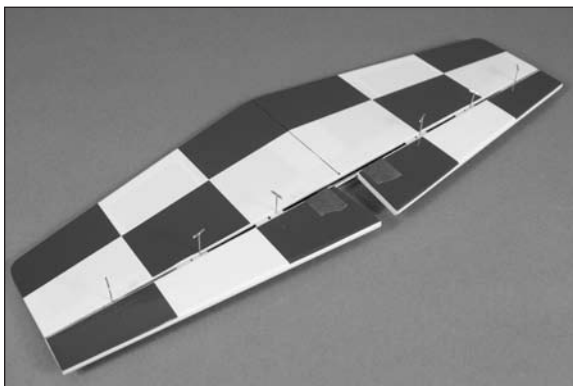

- 11. Make sure the tips of the elevators are aligned with the tips of the stabilizer.

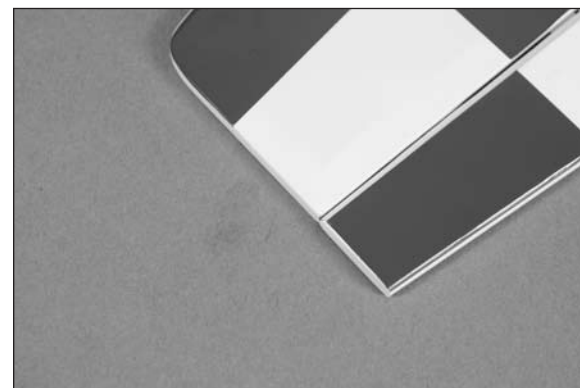

- 12. Press the elevators tightly against the stabilizer. Apply thin CA into the top and bottom of all six hinges.

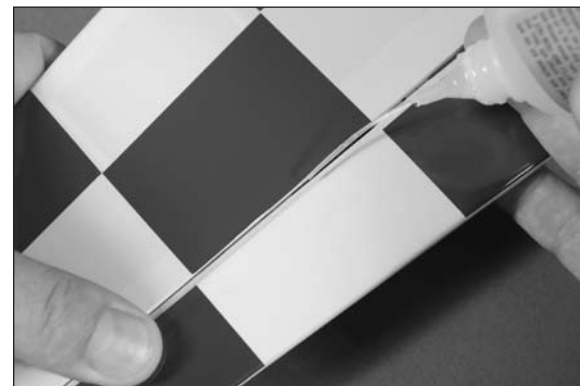

- 13. Once the CA has fully cured. Gently pull on the elevator to make sure the hinges are secure. If any hinges are loose, reapply CA to the hinge. Flex the elevator through its range of motion a number of times to break in the hinges.

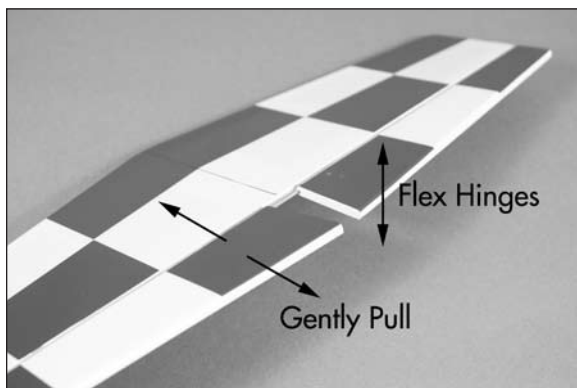

## Wing and Stabilizer Installation

### Required Parts

Fuselage assembly	Wing panels (right and left)
Clip (2)	Stabilizer assembly
Aluminum wing tube	

### Required Tools and Adhesives

30-minute epoxy	Phillips screwdriver: #2
Epoxy brush	Ruler
Felt-tipped pen	Mixing cups
Mixing sticks	Paper towels
T-pin	Low-tack tape
Rubbing alcohol	Hobby knife with #11 blade

- 1. Remove the canopy from the fuselage by sliding it forward, then lifting it from the fuselage at the rear.

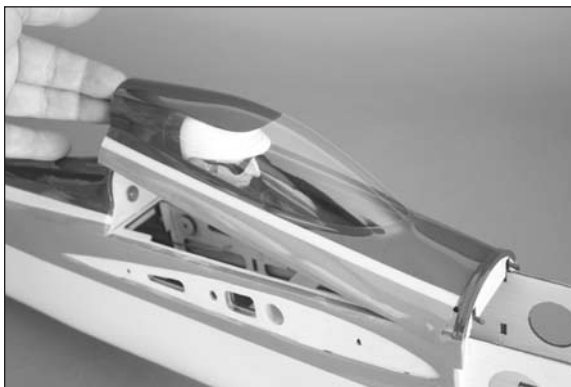

- 2. Slide the aluminum wing tube into the socket in the wing panel. The tube will slide in easily, so do not force it in any farther than it will easily slide.

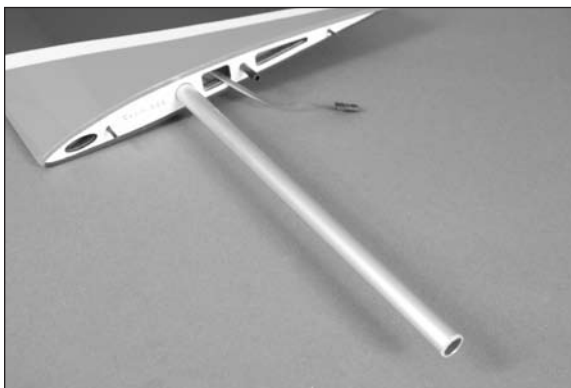

- 3. Slide the tube into the socket in the fuselage. Make sure to guide the lead for the aileron servo in the fuselage when positioning the wing.

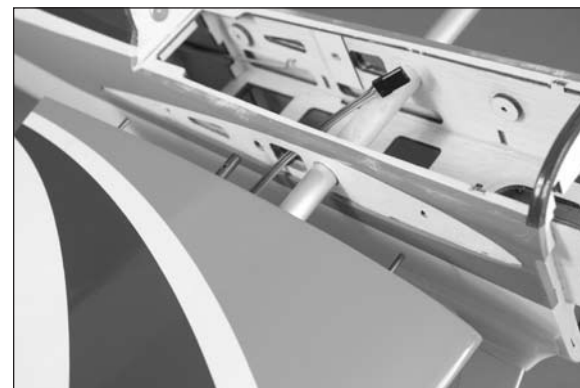

- 4. Use a clip to secure the wing to the fuselage.



- 5. Repeat step 3 to install the second wing panel.

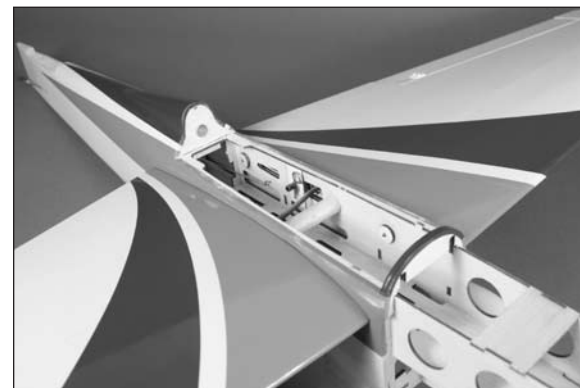

- 6. Place the stabilizer in position. Use a T-pin at the rear of the stabilizer and tape at the front so it can be easily repositioned. The line drawn earlier will help in setting the initial alignment.



- 7. Measure from each wing tip to corresponding stabilizer tip. These measurements must match exactly for the stabilizer to be in alignment. Remove the tape and move the stabilizer if necessary.

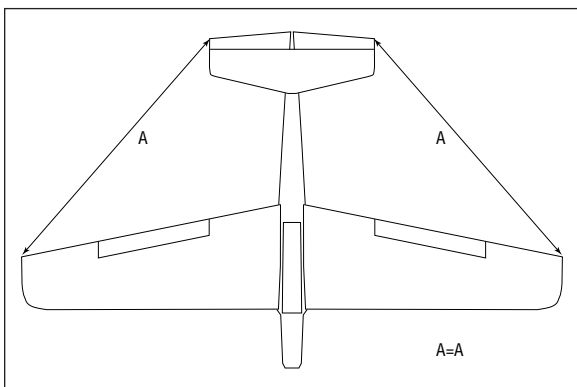

- 8. Step back from the model 3–6 feet (1–2 meters) and view the model from the rear. Check that the wing and stabilizer are in alignment with each other. You might need to lightly sand the stabilizer saddle to bring the wing and stabilizer into alignment.

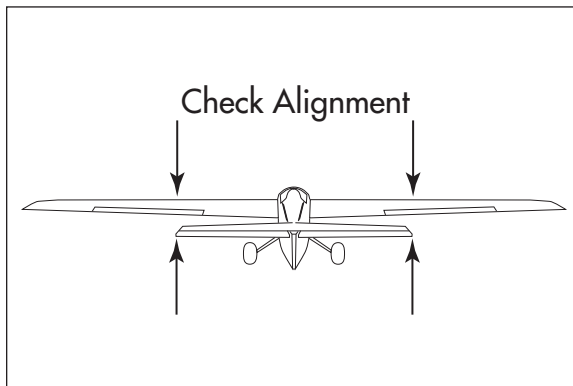

- 9. After the stabilizer has been aligned, trace the outline of the fuselage on the bottom of the stabilizer using a felt-tipped pen.



## ***E-tips***

When cutting the covering, make sure not to cut into the underlying wood and weaken the stabilizer. Another option is to use a soldering iron or hot knife to melt the covering, rather than cutting, to avoid damaging the stabilizer.

- 10. Remove the stabilizer from the fuselage. Use a hobby knife with a new #11 blade to trim the covering 1/16 inch (1.5mm) inside the line drawn in the previous step.



- 11. Mix 1/2 ounce (15ml) of 30-minute epoxy. Lightly brush epoxy on the stabilizer saddle.

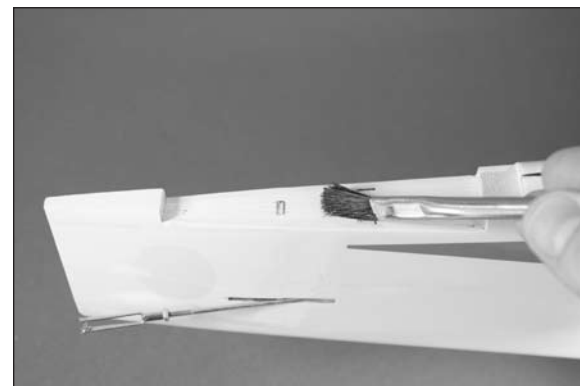

- 12. Lightly brush epoxy on the exposed wood on the bottom of the stabilizer.



- 13. Secure the stabilizer on the fuselage using tape and a T-pin. Use a paper towel and rubbing alcohol to remove any excess epoxy. Allow the epoxy to fully cure before proceeding. Once cured, remove the T-pin and tape from the stabilizer.



- 14. Once the epoxy has fully cured, remove the wing from the fuselage.

## Rudder and Fin Installation

### Required Parts

Fuselage assembly  
Rudder and fin assembly

### Required Tools and Adhesives

30-minute epoxy	Epoxy brush
Square	Felt-tipped pen
Mixing cup	Mixing sticks
Paper towels	Rubbing alcohol
Low-tack tape	Thin CA
Pin vise	Drill bit: 1/16-inch (1.5mm)
T-pins	Phillips screwdriver: #1
Hobby knife with #11 blade	

- 1. Separate the rudder from the fin. Set the hinges aside at this time. Fit the fin into position on the fuselage. Use a felt-tipped pen to trace the outline of the fin on the top of the stabilizer.



### **E-tips**

When cutting the covering, make sure not to cut into the underlying wood and weaken the stabilizer. Another option is to use a soldering iron or hot knife to melt the covering, rather than cutting, to avoid damaging the stabilizer.

- 2. Use a hobby knife with a new #11 blade to trim the covering 1/16 inch (1.5mm) inside the line drawn in the previous step.



- 3. Mix 1/2 ounce (15ml) of 30-minute epoxy. Lightly brush a thin layer of 30-minute epoxy on the exposed wood of the stabilizer.



- 4. Brush a thin layer of epoxy on the bottom of the fin as shown.

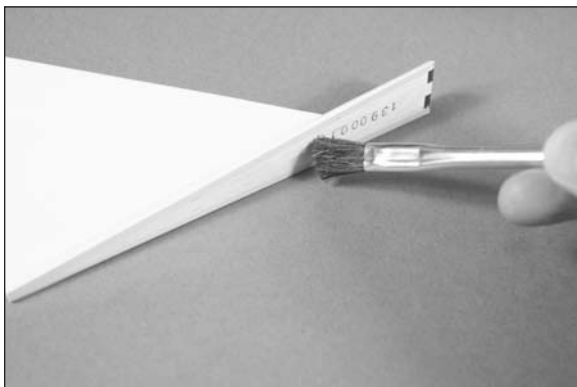

- 5. Position the fin back on the fuselage. Use a paper towel and rubbing alcohol to remove any excess epoxy.



- 6. Use a square to make sure the fin is aligned with the stabilizer.



- 7. Use low-tack tape to keep the fin in alignment with the stabilizer until the epoxy fully cures.

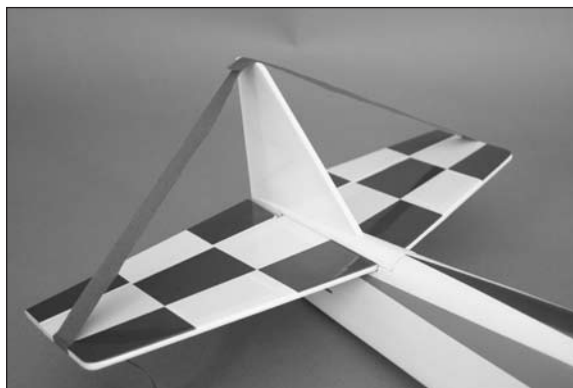

- 8. Use a pin vise and 1/16-inch (1.5mm) drill bit to drill a hole in the center of each hinge slot. Drill holes in both the rudder and fin at this time. This creates a tunnel for the CA to wick into, making a better bond between the hinge and surrounding wood.



- 9. Place a T-pin in the center of each of the three hinges. This will center the hinges when installed in the rudder.

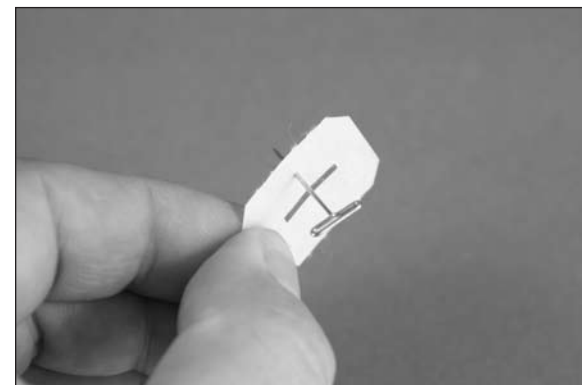



- 10. Insert the hinges in the rudder.



- 11. Press the rudder tightly against the fin. Remove the T-pins and apply thin CA to both sides of the three hinges.



- 12. Once the CA has fully cured. Gently pull on the rudder to make sure the hinges are secure. If any hinges are loose, reapply CA and flex the rudder through its range of motion a number of times to break them in.

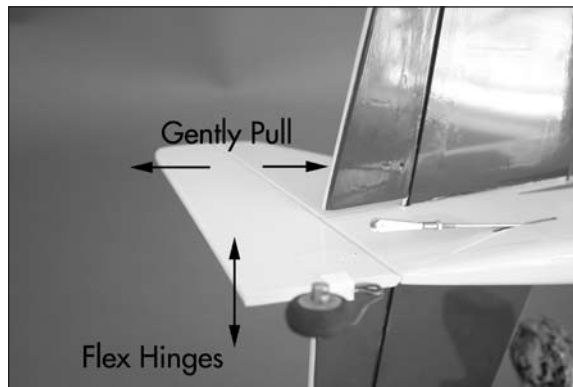

## Servo and Receiver Installation

### Required Parts

Fuselage assembly	Servo with hardware (2)
Receiver	Receiver battery
Transmitter	Control horn (2)
2mm x 12mm sheet metal screw (4)	
Control horn backplate (2)	
Hook and loop tape (not included)	

### Required Tools and Adhesives

Pencil	Thin CA
Pin vise	Side cutters
Needle nose pliers	Phillips screwdriver: #1
Drill bit: 1/16-inch (1.5mm), 5/64-inch (2mm)	

- 1. Prepare the rudder servo by installing the grommets and brass eyelets. Place the rudder servo in the fuselage with the output shaft to the front of the fuselage. Position the servo so the edge toward the center is centered in the opening. Use a pencil to transfer the positions for the mounting screws on the servo tray.

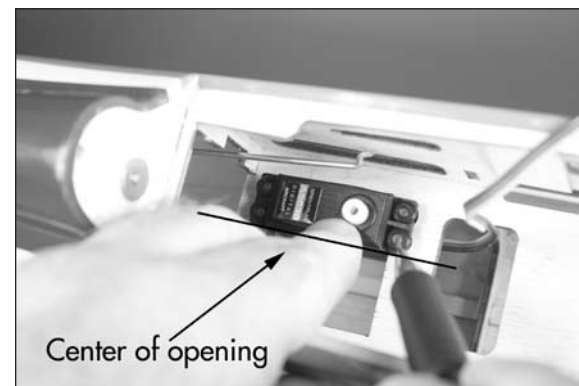

- 2. Remove the servo from the fuselage. Use a pin vise and 1/16-inch (1.5mm) drill bit to drill the four holes for the servo mounting screws.

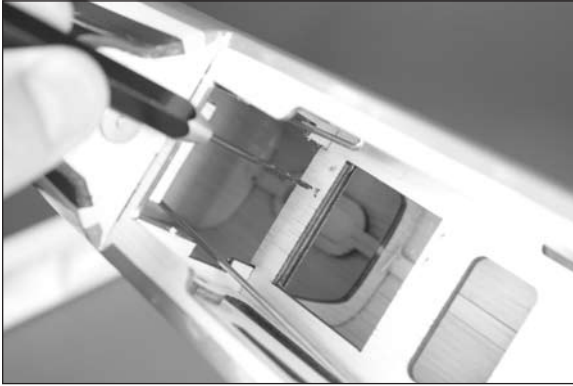

- 3. Use a #1 Phillips screwdriver to thread a servo mounting screw into each of the holes to cut threads in the surrounding wood. Remove the screw before moving to the next step. Prepare all four mounting holes at this time.

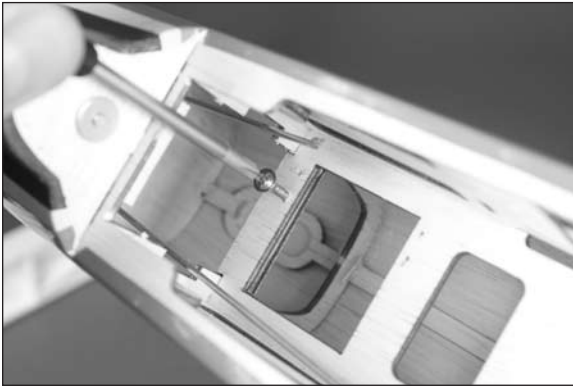

- 4. Place 2-3 drops of thin CA in each hole to harden the surrounding wood. This harder surface makes the screws more secure when installed.

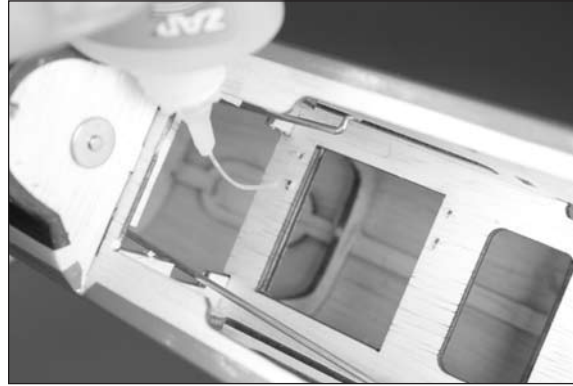

- 5. Return the servo to the fuselage. Use a #1 Phillips screwdriver and the screws provided with the servo to secure it in the fuselage.

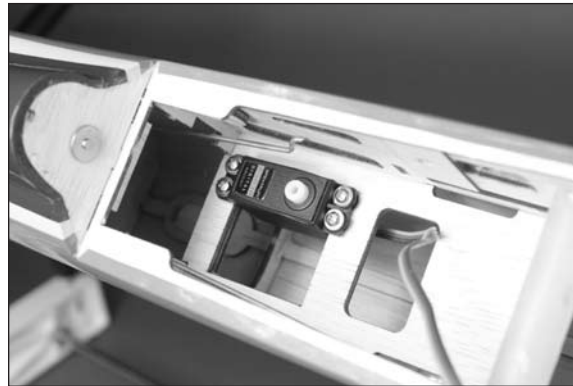

- 6. Use a pin vise and 5/64-inch (2mm) drill bit to enlarge the hole in the servo arm 3/8 inch (10mm) from the center of the servo horn. Remove the arms from the servo horn that will not be used using side cutters.

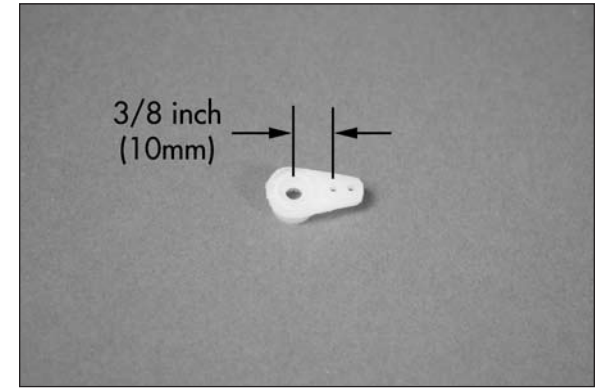

- 7. Insert the Z-bend from the pushrod wire through the hole in the servo horn. Use the radio system to center the rudder servo. Install the servo horn so it is perpendicular to the servo center line. Secure the horn using the screw from the servo and a #1 Phillips screwdriver.

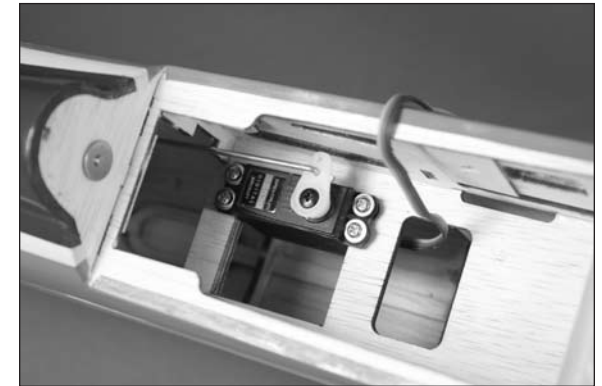

- ○ 8. Use a pin vise and 5/64-inch (2mm) drill bit to drill the two locations for the control horn mounting screws. The locations have been pre-drilled at the factory.



- ○ 9. Secure the control horn to the rudder using two 2mm x 12mm sheet metal screws and a control horn backplate. Tighten the screws using a #1 Phillips screwdriver.



- ○ 10. Use a square or straight edge to make sure the rudder is in alignment with the fin. The clevis attaches to the outer hole on the control horn. Adjust the clevis as necessary so the rudder is aligned with the fin when the rudder servo is centered. Once aligned, use needle nose pliers to tighten the nut against the clevis to keep it from vibrating loose.

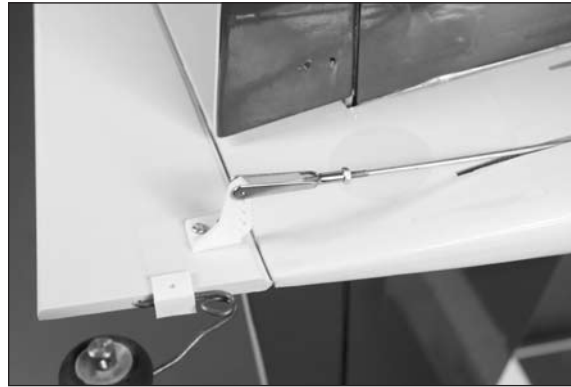

- 11. Repeat steps 3 through 10 to connect the elevator pushrod wire. The positions and measurements for the elevator connections are the same as the rudder.



- 12. Use hook and loop tape to install the receiver in the fuselage. Connect the rudder and elevator servo to the receiver. Secure the remote receiver in the fuselage using hook and loop tape.



**E-tips**

When flying in extreme High-G racing, it may be a good idea to use a tie-wrap (not included) to secure the position of the receiver.

## Motor and Speed Control Installation

### Required Parts

Fuselage assembly    Motor battery  
Tie-wrap (not included) (2)  
3mm lock washer (4)

### Required Parts (Power 15)

Power 15 motor with accessories  
Electronic speed control (ESC) 40-Amp  
Aluminum spacer, 9/16-inch (14mm) (4)  
3mm x 25mm socket head cap screw (4)

### Required Parts (Power 25)

Power 25 motor with accessories  
Electronic speed control (ESC) 60-Amp  
Aluminum spacer, 5/16-inch (7mm) (4)  
3mm x 20mm button head machine screw (4)

### Required Tools and Adhesives

Threadlock                      Hook and loop tape  
Hook and loop strap  
Phillips screwdriver: #2  
Hex wrench or ball driver: 2mm (Power 25) or  
2.5mm (Power 15)

**E-tips**

Always use threadlock on metal-to-metal fasteners to prevent them from vibrating loose.

- 1. Use a #2 Phillips screwdriver to attach the X-mount to the motor using the screws provided with the motor.

Power 15



Power 25



- 2a. Attach the Power 15 motor to the firewall using four 14mm spacers, 3mm x 25mm socket head screws and four 3mm lock washers. Tighten the screws using a 2.5mm hex wrench or ball driver.

Power 15



Power 25



- 3. Route the leads for the motor through the hole in the firewall.

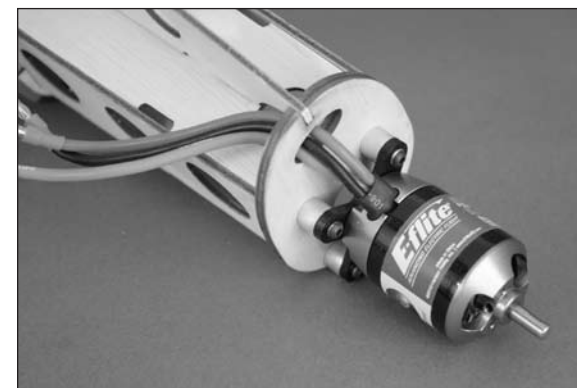

- 4. Loop a tie-wrap (not included) through the plate in the fuselage right above the landing gear plate. Make sure the tie-wrap is not looped through the battery mounting plate.



- 5. Slide the speed control into the fuselage with the battery wires, receiver lead and switch going in and through the tie-wrap. Position the speed control, then tighten the tie-wrap to secure the speed control in the fuselage. The heat sink will face the top of the fuselage.

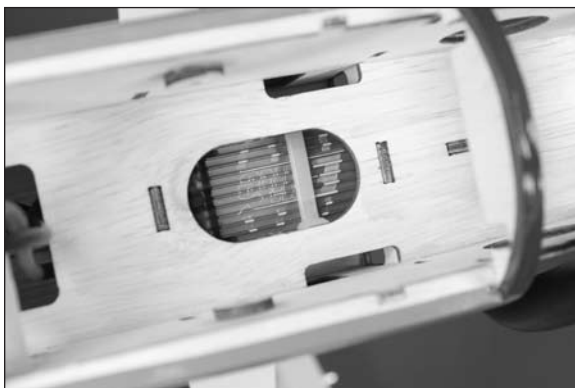

## ***E-tips***

Matching the colors between the ESC and motor when they are connected results in the correct motor direction if using all E-flite components.

- 6. Connect the wires from the motor to the wires of the speed control. Use a tie-wrap (not included) to secure the leads so they don't interfere with the operation of the motor or installation of the cowling.

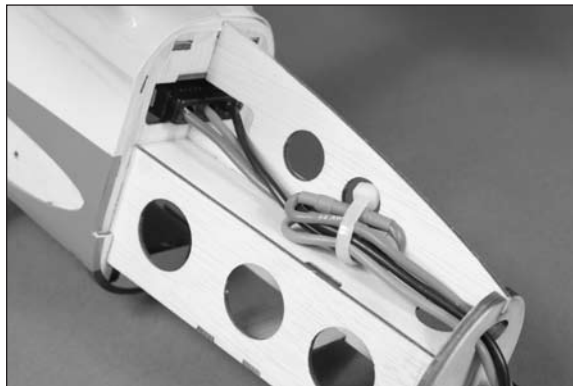

- 7. Route the battery lead through the opening in the fuselage. The lead for the receiver is routed under the battery tray and receiver, then plugged into the throttle channel of the receiver. Mount the switch from the speed control in the fuselage where it can be accessed when the canopy is removed.



- 9. Secure the battery in the fuselage using a hook and loop strap. Also, place hook and loop tape on the battery and fuselage where they contact each other to prevent the battery from moving.

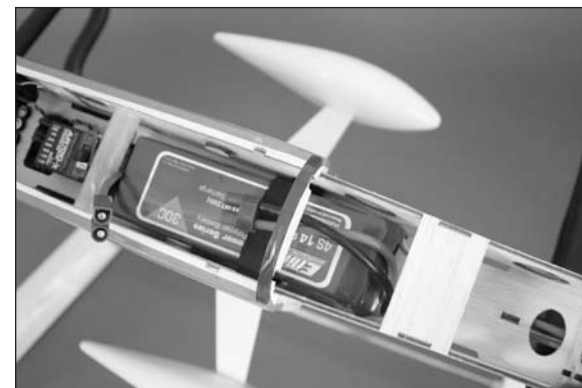

## Cowling Installation

### Required Parts

Fuselage assembly    Cowling  
Canopy                  Propeller  
2mm x 6mm sheet metal screw (4)  
Spinner backplate with adapter (not included)

### Required Tools and Adhesives

Low-tack tape            Thin CA  
Pin vise                  Phillips screwdriver: #1  
Hex wrench or ball driver: 3/32-inch  
Open end or box wrench: 13mm  
Drill bit: 1/32-inch (1mm), 5/64-inch (2mm)

- 1. Use a pin vise and 5/64-inch (2mm) drill bit to drill the four holes in the cowl for the mounting screws. Indentations in the cowl show where these holes should be drilled.



- 2. Place the canopy back on the fuselage and attach the wings. Slide the cowl on the fuselage. You will need to flex the cowl to fit it over the landing gear fairings on the bottom of the fuselage.



### **E-tips**

Always balance your propeller. An unbalanced propeller can cause vibrations to be transmitted into the airframe, which could damage the airframe or other components as well as produce unwanted flight characteristics.

- 3. Prepare the spinner assembly by sliding the propeller on the adapter shaft. Place the adapter nut on the shaft, but do not tighten it at this time.



- 4. Slide the propeller adapter and spinner backplate on the motor shaft. Check that the cowl is aligned with the spinner backplate. There should also be a 5/64 inch (2mm) gap between the backplate and cowl. Use two pieces of low-tack tape to hold the cowl in position on the fuselage.



- 6. Once aligned, use a pin vise and 1/32-inch (1mm) drill bit to drill through the holes in the cowl and into the fuselage.

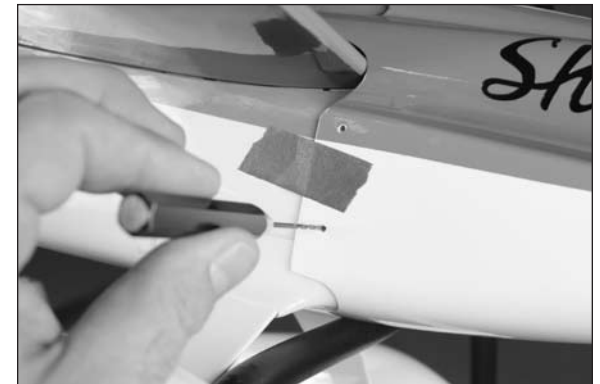

- 7. Remove the cowl from the fuselage. Use a #1 Phillips screwdriver to thread a 2mm x 6mm sheet metal screw into the cowl mounting holes to cut threads in the surrounding wood. Remove the screw before moving to the next step. Prepare all four mounting holes at this time.



- 8. Remove the cowl from the fuselage. Place 1–2 drops of thin CA in each hole to harden the surrounding wood. This harder surface makes the screws more secure when installed.

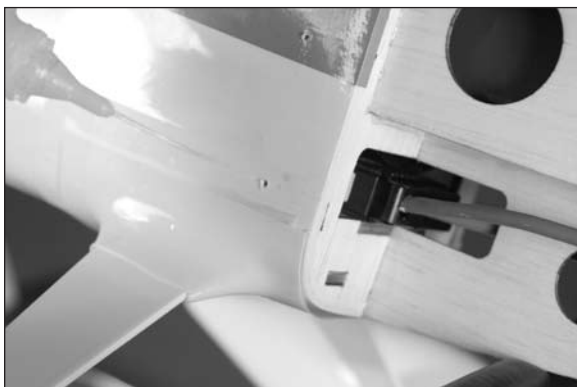

- 9. The cowl can now be secured to the fuselage using the four 2mm x 6mm sheet metal screws. Tighten the screws using a #1 Phillips screwdriver.



- 10. Install the propeller adapter and backplate on the motor shaft. Use a 13mm box wrench or open end wrench to tighten the propeller nut.



- 11. Position the spinner cone. Make sure the opening in the spinner cone does not contact the propeller. Use a 3/32-inch hex wrench or ball driver to tighten the screw that secures the spinner cone.



## Decal Installation

### Required Parts

Fuselage assembly    Wing assembly

### Required Tools and Adhesives

Spray bottle                      Dish washing detergent  
Paper towel                      Hobby knife with #11 blade

- 1. Apply the decals to your model using the photos located in this section of the manual and the box art from your model. Use a spray bottle and a drop of dish washing liquid sprayed in the location of the decal to allow repositioning. Use a paper towel as a squeegee to remove excess water from under the decal. Allow the model to rest overnight so the remaining water can evaporate.

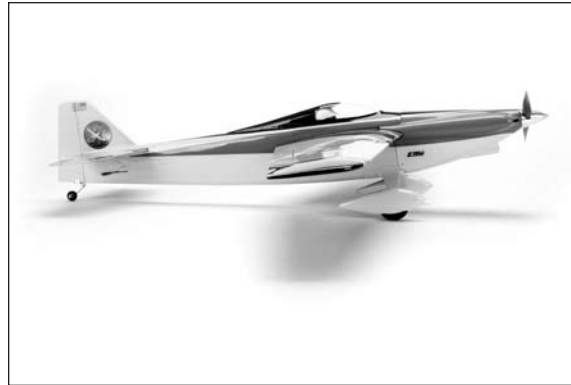
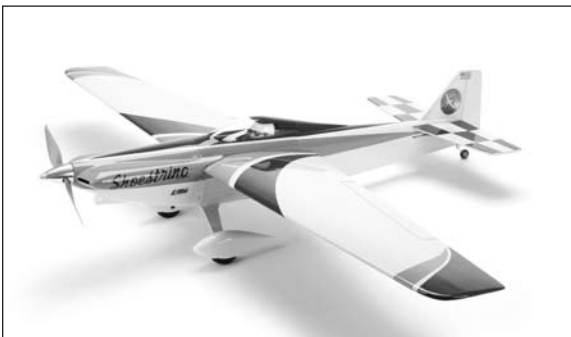

## Center of Gravity

### Required Parts

Assembled airframe

### Required Tools and Adhesives

Felt-tipped pen                      Ruler  
Balancing stand (optional)

An important part of preparing the aircraft for flight is properly balancing the model.

**⚠ CAUTION:** Do not inadvertently skip this step or property damage and injury could occur.

- 1. Assemble your model in preparation for flight, making sure the wing is on securely and the motor battery is installed as instructed in this manual.
- 2. The recommended Center of Gravity (CG) location for your model is  $2\frac{3}{8}$  to  $2\frac{5}{8}$  inches (60 to 66mm) back from the leading edge of the wing as shown with the battery pack installed. Mark the location of the CG on the bottom of the wing with a felt-tipped pen.

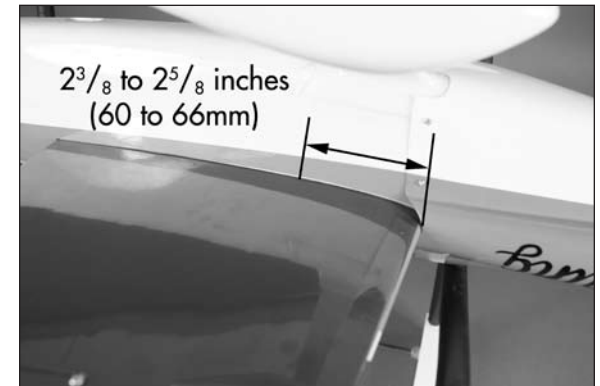



- 3. When balancing your model, support the plane upright at the marks made on the bottom of the wing with your fingers or a commercially available balancing stand. This is the correct balance point for your model. Make sure your model is assembled and ready for flight before balancing.

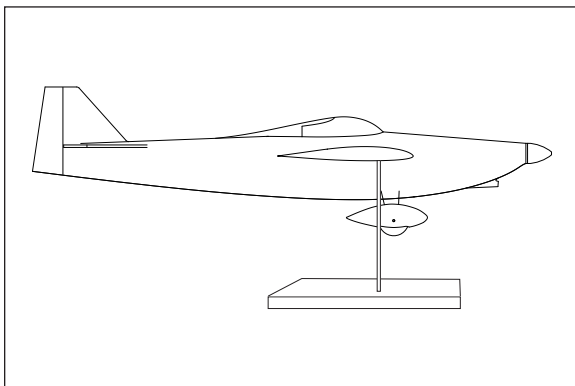

Adjust the motor battery as necessary so the model is level or slightly nose down. This is the correct balance point for your model. You should find the CG to be very close with the battery installed as shown in this manual. Mark the location of the battery on the battery tray using a felt-tipped pen so it can be returned to this position if it is removed from your model.

After the first flights, the CG position can be adjusted for your personal preference.

## Control Throws

- 1. Turn on the transmitter and receiver of your model. Check the movement of the rudder using the transmitter. When the stick is moved right, the rudder should also move right. Reverse the direction of the servo at the transmitter if necessary.
- 2. Check the movement of the elevator with the radio system. Moving the elevator stick toward the bottom of the transmitter should make the airplane elevator move up.
- 3. Check the movement of the ailerons with the radio system. Moving the aileron stick right should make the right aileron move up and the left aileron move down.
- 4. Use a ruler to adjust the throw of the elevator, ailerons and rudder. Adjust the position of the pushrod at the control horn to achieve the following measurements when moving the sticks to their endpoints:

### Aileron

High Rate		
Up:	3/8-inch	10mm
Down:	1/4-inch	6mm
Low Rate		
Up:	5/16-inch	8mm
Down:	3/16-inch	5mm

### Elevator

High Rate		
Up:	9/32-inch	7mm
Down:	1/4-inch	6mm
Low Rate		
Up:	3/16-inch	5mm
Down:	5/32-inch	4mm

### Rudder

High Rate		
Right:	11/16-inch	17mm
Left:	11/16-inch	17mm
Low Rate		
Right:	19/32-inch	15mm
Left:	19/32-inch	15mm

**E-tips**

Measurements are taken at the inner or widest point on the control surface.

These are general guidelines measured from our own flight tests. You can experiment with higher rates to match your preferred style of flying.

**E-tips**

Travel Adjust and Sub-Trims are not listed and should be adjusted according to each individual model and preference.

**E-tips**

We highly recommend re-binding the radio system once all the control throws are set. This will keep the servos from moving to their endpoints until the transmitter and receiver connect.

## Preflight

### Check Your Radio

Before going to the field, make sure your batteries are fully charged per the instructions included with your radio. Charge the transmitter and motor battery for your airplane. Use the recommended charger supplied with your particular radio system, following the instructions provided with the radio. In most cases, the radio should be charged the night before going out flying.

Before each flying session, range check your radio. See your radio manual for the recommended range and instructions for your radio system. Each radio manufacturer specifies different procedures for their radio systems. Next, run the motor. With the model securely anchored, check the range again. The range test should not be significantly affected. If it is, do not attempt to fly! Have your radio equipment checked out by the manufacturer.

Double-check that all controls (aileron, elevator, rudder and throttle) move in the correct direction.

Check the radio installation and make sure all the control surfaces are moving correctly (i.e., the correct direction and with the recommended throws).

Check all the control horns, servo horns, and clevises to make sure they are secure and in good condition.

## Range Test Your Radio

Before each flying session, and especially with a new model, it is important to perform a range check. It is helpful to have another person available to assist during the range check. If you are using a Spektrum™ transmitter, please refer to your transmitter's manual for detailed instructions on the range check process.

- 1. With the model resting on the ground, stand 30 paces (approximately 90 feet) away from the model.
- 2. Face the model with the transmitter in your normal flying position. Ensure the throttle is in the full down position and plug the flight battery into the speed control.
- 3. As you move the controls, watch to be sure the airplane's motor and controls operate smoothly. You should have total control of the model at 30 paces (90 feet).
- 4. If control issues exist, call the appropriate Horizon Product Support office (see addresses listed in the Warranty Services section of this manual) or go to [horizonhobby.com](http://horizonhobby.com) to find a local Spektrum distributor in your country for service when using a Spektrum™ radio system.

## Flying Your Model

### POWER 15 SPORT SETUP

If you followed the suggestions for the sport setup, you'll have adequate control throws to do just about any aerobatic maneuver you want from an airplane that is designed to fly fast. Balance the airplane at the  $2\frac{3}{8}$  inches (60mm) mark to start with and then adjust fore and aft from there by moving the motor battery. The initial CG will provide a very solid feeling airplane that will readily stall with full up elevator, which gives good control for landings.

#### Take-off

Use care with a 10-inch propeller mounted, especially off the grass. A smooth application of throttle will result in a fairly straight takeoff run, needing a small amount of right rudder. When the tailwheel is on the ground (before the tail has risen) it provides good authority against any torque-induced yaw.... Once the tailwheel lifts off the ground, be prepared to apply additional right rudder to keep the airplane on a straight path. It takes about 8–10 seconds for the airplane to gain full speed, but you don't have to wait for this speed to have fun. With the light wing loading, you'll find the Shoestring 15e to be very maneuverable and fun to fly.

### POWER 25 1250KV RACING SETUP

This setup is an entirely different animal. This setup will raise the top speed from around 80 mph to 115 mph and will provide you with many hours of pure adrenaline (at 4 minutes or so per flight). The size of the loops you can do will amaze you. Balance the airplane at the  $2\frac{3}{8}$  inches (60mm) mark to start with and then adjust fore and aft from there by moving the motor battery. The initial CG will provide a very solid feeling airplane that will readily stall with full up (high-rate) elevator, which gives good control for landings. We recommend following the suggestions on the pushrod attachment in the manual for the racing setup. Using the inner holes at the servo will result in the greatest amount of torque being delivered to the control surface. At these speeds, it is good to have a reserve of holding power and extra torque.

## Take-off

With the high Kv motor and a small 8-inch propeller, there is a ton of torque coming from your motor, so be prepared on your first takeoff. The airplane will easily come off the ground at 1/2 throttle, so if you stop yourself from going full bore and wait to apply full power until well airborne, your takeoffs will be easier and a thing of beauty. While the tailwheel is on the ground it provides good authority against any torque-induced yaw, but once the tailwheel lifts off, be prepared to apply additional right rudder to keep the airplane on a straight path. With an 8-inch pitch prop, it takes a full 15 seconds for the airplane to gain full speed.

### Racing tips

The key to going fast and maintaining your speed is to induce the least amount of drag while you are flying the airplane. Every time you move a flight control you increase the drag, so use very little control surface movement to help with this. Get used to using a lot of stick movement on your transmitter (on all axes) and your ability to make smooth corrections and fly a faster line through the air will increase tremendously.

I like to set up my transmitter so almost full elevator stick movement is required to complete a turn around a pylon. Ailerons are set up so a complete full roll takes 2–3 seconds (the distance from one end of a racing course to the other). I usually also set up my rudder so that full right rudder will provide a straight takeoff run with a wide open throttle. I also mix in a little rudder with aileron movement (about 4%); just enough so you can roll from right knife edge to left knife edge and back again without gaining any altitude.

Some tips on passing your racing friends. Stay above their racing line. There is a tremendous amount of what we call bad air (turbulence) right behind and below them. While it might seem cool and exciting to execute a pass below, at these speeds there is rarely any time to correct from turbulence before your beloved racer is in the ground. Take heed!

## Landing

Landing your model is identical whether you are using the Sport (Power 15) or Racing (Power 25) setups. With the wing loading at about 21 ounces per square foot, the landing speeds for this airplane are actually very slow ... if you can get it to slow down. It is a very clean airplane and if you let the nose drop on approach, it will pick up all the speed you just worked so hard to lose. Just go to high rate to make sure you have adequate elevator once you get the airplane slowed down when it is least effective. Plan your approach and be prepared to make a go-around on the first few tries. You'll get the hang of it very quickly.

Happy Landings!

## Daily Flight Checks

- 1. Check the battery voltage of the transmitter battery. Do not fly below the manufacturer's recommended voltage. To do so may cause your aircraft to crash.

### ***E-tips***

When you check these batteries, ensure you have the polarities correct on your expanded scale voltmeter.

- 2. Check all hardware (linkages, screws, nuts, and bolts) prior to each day's flight. Ensure the control surfaces and linkages are not binding and all parts are properly secured.
- 3. Ensure all surfaces are moving in the proper manner.
- 4. Perform a ground range check before each day's flying session.
- 5. Prior to starting your aircraft, turn off your transmitter, then turn it back on. Do this each time you start your aircraft. If any critical switches are on without your knowledge, the transmitter alarm will sound a warning.
- 6. Check that all trim levers are in the proper location.
- 7. All servo pigtails and switch harness plugs should be secured in the receiver. Make sure the switch harness moves freely in both directions.

## Limited Warranty

### WHAT THIS WARRANTY COVERS

Horizon Hobby, Inc. ("Horizon") warrants to the original purchaser that the product purchased (the "Product") will be free from defects in materials and workmanship at the date of purchase.

### WHAT IS NOT COVERED

This warranty is not transferable and does not cover (i) cosmetic damage, (ii) damage due to acts of God, accident, misuse, abuse, negligence, commercial use, or due to improper use, installation, operation or maintenance, (iii) modification of or to any part of the Product, (iv) attempted service by anyone other than a Horizon Hobby authorized service center, or (v) Products not purchased from an authorized Horizon dealer.

OTHER THAN THE EXPRESS WARRANTY ABOVE, HORIZON MAKES NO OTHER WARRANTY OR REPRESENTATION, AND HEREBY DISCLAIMS ANY AND ALL IMPLIED WARRANTIES, INCLUDING, WITHOUT LIMITATION, THE IMPLIED WARRANTIES OF NON-INFRINGEMENT, MERCHANTABILITY AND FITNESS FOR A PARTICULAR PURPOSE. THE PURCHASER ACKNOWLEDGES THAT THEY ALONE HAVE DETERMINED THAT THE PRODUCT WILL SUITABLY MEET THE REQUIREMENTS OF THE PURCHASER'S INTENDED USE.

### PURCHASER'S REMEDY

Horizon's sole obligation and purchaser's sole and exclusive remedy shall be that Horizon will, at its option, either (i) service, or (ii) replace, any Product determined by Horizon to be defective. Horizon reserves the right to inspect any and all Product(s) involved in a warranty claim. Service or replacement decisions are at the sole discretion of Horizon. Proof of purchase is required for all warranty claims. SERVICE OR REPLACEMENT AS PROVIDED UNDER THIS WARRANTY IS THE PURCHASER'S SOLE AND EXCLUSIVE REMEDY.

## LIMITATION OF LIABILITY

HORIZON SHALL NOT BE LIABLE FOR SPECIAL, INDIRECT, INCIDENTAL OR CONSEQUENTIAL DAMAGES, LOSS OF PROFITS OR PRODUCTION OR COMMERCIAL LOSS IN ANY WAY, REGARDLESS OF WHETHER SUCH CLAIM IS BASED IN CONTRACT, WARRANTY, TORT, NEGLIGENCE, STRICT LIABILITY OR ANY OTHER THEORY OF LIABILITY, EVEN IF HORIZON HAS BEEN ADVISED OF THE POSSIBILITY OF SUCH DAMAGES. Further, in no event shall the liability of Horizon exceed the individual price of the Product on which liability is asserted. As Horizon has no control over use, setup, final assembly, modification or misuse, no liability shall be assumed nor accepted for any resulting damage or injury. By the act of use, setup or assembly, the user accepts all resulting liability. If you as the purchaser or user are not prepared to accept the liability associated with the use of the Product, purchaser is advised to return the Product immediately in new and unused condition to the place of purchase.

## LAW

These terms are governed by Illinois law (without regard to conflict of law principals). This warranty gives you specific legal rights, and you may also have other rights which vary from state to state. Horizon reserves the right to change or modify this warranty at any time without notice.

## Warranty Services

### QUESTIONS, ASSISTANCE, AND SERVICES

Your local hobby store and/or place of purchase cannot provide warranty support or service. Once assembly, setup or use of the Product has been started, you must contact Horizon directly. This will enable Horizon to better answer your questions and service you in the event that you may need any assistance. For questions or assistance, please direct your email to [productsupport@horizonhobby.com](mailto:productsupport@horizonhobby.com), or call 877.504.0233 toll free to speak to a Product Support representative. You may also find information on our website at [www.horizonhobby.com](http://www.horizonhobby.com).

### INSPECTION OR SERVICES

If this Product needs to be inspected or serviced, please use the Horizon Online Service Request submission process found on our website or call Horizon to obtain a Return Merchandise Authorization (RMA) number. Pack the Product securely using a shipping carton. Please note that original boxes may be included, but are not designed to withstand the rigors of shipping without additional protection. Ship via a carrier that provides tracking and insurance for lost or damaged parcels, as Horizon is not responsible for merchandise until it arrives and is accepted at our facility. An Online Service Request is available at <http://www.horizonhobby.com> under the Support tab. If you do not have internet access, please contact Horizon Product Support to obtain a RMA number along with instructions for submitting your product for service. When calling Horizon, you will be asked to provide your complete name, street address, email address and phone number where you can be reached during business hours. When sending product into Horizon, please include your RMA number, a list of the included items, and a brief summary of the problem. A copy of your original sales receipt must be included for warranty consideration. Be sure your name, address, and RMA number are clearly written on the outside of the shipping carton.

**Notice: Do not ship LiPo batteries to Horizon. If you have any issue with a LiPo battery, please contact the appropriate Horizon Product Support office.**

## WARRANTY REQUIREMENTS

**For Warranty consideration, you must include your original sales receipt verifying the proof-of-purchase date.** Provided warranty conditions have been met, your Product will be serviced or replaced free of charge. Service or replacement decisions are at the sole discretion of Horizon.

## NON-WARRANTY SERVICE

**Should your service not be covered by warranty service will be completed and payment will be required without notification or estimate of the expense unless the expense exceeds 50% of the retail purchase cost.** By submitting the item for service you are agreeing to payment of the service without notification. Service estimates are available upon request. You must include this request with your item submitted for service. Non-warranty service estimates will be billed a minimum of ½ hour of labor. In addition you will be billed for return freight. Horizon accepts money orders and cashiers checks, as well as Visa, MasterCard, American Express, and Discover cards. By submitting any item to Horizon for service, you are agreeing to Horizon's Terms and Conditions found on our website <http://www.horizonhobby.com/Service/Request/>.

## UNITED STATES

*(Electronics and engines)*

Horizon Service Center  
4105 Fieldstone Rd  
Champaign, Illinois  
61822 USA  
productsupport@horizonhobby.com  
877-504-0233  
Online Repair Request visit:  
[www.horizonhobby.com/service](http://www.horizonhobby.com/service)

*(All other products)*

Horizon Product Support  
4105 Fieldstone Rd  
Champaign, Illinois  
61822 USA  
productsupport@horizonhobby.com  
877-504-0233

## UNITED KINGDOM

Horizon Hobby Limited  
Units 1-4 Ployters Rd  
Staple Tye  
Harlow, Essex  
CM18 7NS  
United Kingdom  
sales@horizonhobby.co.uk  
+44 (0) 1279 641 097

## GERMANY

Horizon Technischer Service  
Christian-Junge-Straße 1  
25337 Elmshorn  
Germany  
service@horizonhobby.de  
+49 4121 46199 66

## FRANCE

Horizon Hobby SAS  
14 Rue Gustave Eiffel  
Zone d'Activité du Réveil Matin  
91230 Montgeron  
+33 (0) 1 60 47 44 70

## Compliance Information for the European Union



### INSTRUCTIONS FOR DISPOSAL OF WEEE BY USERS IN THE EUROPEAN UNION

This product must not be disposed of with other waste. Instead, it is the user's responsibility to dispose of their waste equipment by handing it over to a designated collection point for the recycling of waste electrical and electronic equipment. The separate collection and recycling of your waste equipment at the time of disposal will help to conserve natural resources and ensure that it is recycled in a manner that protects human health and the environment. For more information about where you can drop off your waste equipment for recycling, please contact your local city office, your household waste disposal service or where you purchased the product.

## Academy of Model Aeronautics National Model Aircraft Safety Code

*Effective January 1, 2011*

### A. GENERAL

A model aircraft is a non-human-carrying aircraft capable of sustained flight in the atmosphere. It may not exceed limitations of this code and is intended exclusively for sport, recreation and/or competition. All model flights must be conducted in accordance with this safety code and any additional rules specific to the flying site.

1. Model aircraft will not be flown:
  - (a) In a careless or reckless manner.
  - (b) At a location where model aircraft activities are prohibited.
2. Model aircraft pilots will:
  - (a) Yield the right of way to all man carrying aircraft.
  - b) See and avoid all aircraft and a spotter must be used when appropriate. (AMA Document #540-D-See and Avoid Guidance.)
  - (c) Not fly higher than approximately 400 feet above ground level within three (3) miles of an airport, without notifying the airport operator.
  - (d) Not interfere with operations and traffic patterns at any airport, heliport or seaplane base except where there is a mixed use agreement.
  - (e) Not exceed a takeoff weight, including fuel, of 55 pounds unless in compliance with the AMA Large Model Aircraft program. (AMA Document 520-A)
  - (f) Ensure the aircraft is identified with the name and address or AMA number of the owner on the inside or affixed to the outside of the model aircraft. (This does not apply to model aircraft flown indoors).
  - (g) Not operate aircraft with metal-blade propellers or with gaseous boosts except for helicopters operated under the provisions of AMA Document #555.
  - (h) Not operate model aircraft while under the influence of alcohol or while using any drug which could adversely affect the pilot's ability to safely control the model.
  - (i) Not operate model aircraft carrying pyrotechnic devices which explode or burn, or any device which propels a projectile or drops any object that creates a hazard to persons or property.

Exceptions:

- Free Flight fuses or devices that burn producing smoke and are securely attached to the model aircraft during flight.
  - Rocket motors (using solid propellant) up to a G-series size may be used provided they remain attached to the model during flight. Model rockets may be flown in accordance with the National Model Rocketry Safety Code but may not be launched from model aircraft.
  - Officially designated AMA Air Show Teams (AST) are authorized to use devices and practices as defined within the Team AMA Program Document (AMA Document #718).
    - (j) Not operate a turbine-powered aircraft, unless in compliance with the AMA turbine regulations. (AMA Document #510-A).
3. Model aircraft will not be flown in AMA sanctioned events, air shows or model demonstrations unless:
- (a) The aircraft, control system and pilot skills have successfully demonstrated all maneuvers intended or anticipated prior to the specific event.
  - (b) An inexperienced pilot is assisted by an experienced pilot.
4. When and where required by rule, helmets must be properly worn and fastened. They must be OSHA, DOT, ANSI, SNELL or NOCSAE approved or comply with comparable standards.

#### **B. RADIO CONTROL (RC)**

1. All pilots shall avoid flying directly over unprotected people, vessels, vehicles or structures and shall avoid endangerment of life and property of others.
2. A successful radio equipment ground-range check in accordance with manufacturer's recommendations will be completed before the first flight of a new or repaired model aircraft.
3. At all flying sites a safety line(s) must be established in front of which all flying takes place (AMA Document #706-Recommended Field Layout):
  - (a) Only personnel associated with flying the model aircraft are allowed at or in front of the safety line.
  - (b) At air shows or demonstrations, a straight safety line must be established.
  - (c) An area away from the safety line must be maintained for spectators.
  - (d) Intentional flying behind the safety line is prohibited.
4. RC model aircraft must use the radio-control frequencies currently allowed by the Federal Communications Commission (FCC). Only individuals properly licensed by the FCC are authorized to operate equipment on Amateur Band frequencies.

5. RC model aircraft will not operate within three (3) miles of any pre-existing flying site without a frequency-management agreement (AMA Documents #922- Testing for RF Interference; #923- Frequency Management Agreement)
6. With the exception of events flown under official AMA Competition Regulations, excluding takeoff and landing, no powered model may be flown outdoors closer than 25 feet to any individual, except for the pilot and the pilot's helper(s) located at the flight line.
7. Under no circumstances may a pilot or other person touch a model aircraft in flight while it is still under power, except to divert it from striking an individual. This does not apply to model aircraft flown indoors.
8. RC night flying requires a lighting system providing the pilot with a clear view of the model's attitude and orientation at all times.
9. The pilot of a RC model aircraft shall:
  - (a) Maintain control during the entire flight, maintaining visual contact without enhancement other than by corrective lenses prescribed for the pilot.
  - (b) Fly using the assistance of a camera or First-Person View (FPV) only in accordance with the procedures outlined in AMA Document #550.

#### **C. FREE FLIGHT**

1. Must be at least 100 feet downwind of spectators and automobile parking when the model aircraft is launched.
2. Launch area must be clear of all individuals except mechanics, officials, and other fliers.
3. An effective device will be used to extinguish any fuse on the model aircraft after the fuse has completed its function.

#### **D. CONTROL LINE**

1. The complete control system (including the safety thong where applicable) must have an inspection and pull test prior to flying.
2. The pull test will be in accordance with the current Competition Regulations for the applicable model aircraft category.
3. Model aircraft not fitting a specific category shall use those pull-test requirements as indicated for Control Line Precision Aerobatics.
4. The flying area must be clear of all utility wires or poles and a model aircraft will not be flown closer than 50 feet to any above-ground electric utility lines.
5. The flying area must be clear of all nonessential participants and spectators before the engine is started.

## ***Building and Flying Notes***

---

---

---

---

---

---

---

---

---

---

---

---

---

---

---

---

---

---

---

---

---

---

---

---



© 2011 Horizon Hobby, Inc.  
[horizonhobby.com](http://horizonhobby.com)  
[www.e-fliterc.com](http://www.e-fliterc.com)

E-flite, DSMX, Celectra and the Horizon Hobby logo are trademarks or registered trademarks of Horizon Hobby, Inc.  
The Spektrum trademark is used with permission of Bachmann Industries, Inc.

All other trademarks, service marks and logos are the property of their respective owners.