

**axial**<sup>®</sup>  
www.axialracing.com

AXI90074-1001

**WRAITH**<sup>™</sup>

READY-TO-RUN

**WRAITH**<sup>™</sup> **1.9**

1/10th SCALE ELECTRIC 4WD ROCK RACER



INSTRUCTION MANUAL  
BEDIENUNGSANLEITUNG  
MANUEL D'UTILISATION  
MANUALE DI ISTRUZIONI

ROCK RACER SERIES

**HORIZON**<sup>®</sup>  
H O B B Y

## NOTICE

All instructions, warranties and other collateral documents are subject to change at the sole discretion of Horizon Hobby, LLC. For up-to-date product literature, visit [horizonhobby.com](http://horizonhobby.com) and click on the support tab for this product.

## MEANING OF SPECIAL LANGUAGE

The following terms are used throughout the product literature to indicate various levels of potential harm when operating this product:

**WARNING:** Procedures, which if not properly followed, create the probability of property damage, collateral damage, and serious injury OR create a high probability of superficial injury.

**CAUTION:** Procedures, which if not properly followed, create the probability of physical property damage AND a possibility of serious injury.

**NOTICE:** Procedures, which if not properly followed, create a possibility of physical property damage AND a little or no possibility of injury.

 **WARNING:** Read the ENTIRE instruction manual to become familiar with the features of the product before operating. Failure to operate the product correctly can result in damage to the product, personal property and cause serious injury. This is a sophisticated hobby product. It must be operated with caution and common sense and requires some basic mechanical ability. Failure to operate this Product in a safe and responsible manner could result in injury or damage to the product or other property. This product is not intended for use by children without direct adult supervision. Do not use with incompatible components or alter this product in any way outside of the instructions provided by Horizon Hobby, LLC. This manual contains instructions for safety, operation and maintenance. It is essential to read and follow all the instructions and warnings in the manual, prior to assembly, setup or use, in order to operate correctly and avoid damage or serious injury.

**Age Recommendation: Not for children under 14 years. This is not a toy.**

## SAFETY PRECAUTIONS AND WARNINGS

As the user of this product, you are solely responsible for operating in a manner that does not endanger yourself and others or result in damage to the product or property of others.

This model is controlled by a radio signal subject to interference from many sources outside your control. This interference can cause momentary loss of control, so it is advisable to always keep a safe distance in all directions around your model as this margin will help avoid collisions or injury.

- Never operate your model with low transmitter batteries.
- Always operate your model in open spaces away from full-size vehicles, traffic and people.
- Never operate the model in the street or in populated areas for any reason.
- Carefully follow the directions and warnings for this and any optional support equipment (chargers, rechargeable battery packs, etc.) you use.
- Keep all chemicals, small parts and anything electrical out of the reach of children.
- Never lick or place any portion of the model in your mouth as it could cause serious injury or even death.
- Exercise caution when using tools and sharp instruments.
- Take care during maintenance as some parts may have sharp edges.
- Immediately after using your model, do NOT touch equipment such as the motor, electronic speed control and battery, because they generate high temperatures. You may burn yourself seriously touching them.
- Do not put fingers or any objects inside rotating and moving parts, as this may cause damage or serious injury.
- Always turn on your transmitter before you turn on the receiver in the car. Always turn off the receiver before turning your transmitter off.
- Keep the wheels of the model off the ground when checking the operation of the radio equipment.

 **WARNING AGAINST COUNTERFEIT PRODUCTS:** Always purchase from a Horizon Hobby, LLC authorized dealer to ensure authentic high-quality Spektrum product. Horizon Hobby, LLC disclaims all support and warranty with regards, but not limited to, compatibility and performance of counterfeit products or products claiming compatibility with DSM® or Spektrum technology.



## TABLE OF CONTENTS

Water-resistant Vehicle with Waterproof Electronics .....	3	AE-5L Forward/reverse ESC with drag brake .....	10
box Contents .....	4	Gear Ratios.....	11
Required Equipment .....	4	Troubleshooting.....	11
recommended tools.....	4	Notes.....	11
Getting started checklist.....	5	Limited Warranty.....	12
Vehicle parts.....	5	Warranty and Service Contact Information .....	12
Charge the vehicle battery.....	6	FCC Information.....	13
Install the transmitter batteries.....	6	IC Information.....	13
Transmitter functions.....	6	Compliance Information for the European Union.....	13
Install the vehicle battery.....	7	Parts reference .....	50
Binding.....	8	Exploded views.....	55
Range-checking the radio system .....	8	Parts lists.....	59
vehicle maintenance .....	9	Electronics .....	61
Adjusting the battery tray.....	10		

## WATER-RESISTANT VEHICLE WITH WATERPROOF ELECTRONICS

Your new Horizon Hobby vehicle has been designed and built with a combination of waterproof and water-resistant components to allow you to operate the product in many “wet conditions,” including puddles, creeks, wet grass, snow and even rain.

While the entire vehicle is highly water-resistant, it is not completely waterproof and your vehicle should NOT be treated like a submarine. The various electronic components used in the vehicle, such as the Electronic Speed Control (ESC), servo(s) and receiver are waterproof, however, most of the mechanical components are water-resistant and should not be submerged.

Metal parts, including the bearings, hinge pins, screws and nuts, as well as the contacts in the electrical cables, will be susceptible to corrosion if additional maintenance is not performed after running in wet conditions. To maximize the long-term performance of your vehicle and to keep the warranty intact, the procedures described in the “Wet Conditions Maintenance” section below must be performed regularly if you choose to run in wet conditions. If you are not willing to perform the additional care and maintenance required, then you should not operate the vehicle in those conditions.

 **CAUTION:** Failure to exercise caution while using this product and complying with the following precautions could result in product malfunction and/or void the warranty.

### GENERAL PRECAUTIONS

- Read through the wet conditions maintenance procedures and make sure that you have all the tools you will need to properly maintain your vehicle.
- Not all batteries can be used in wet conditions. Consult the battery manufacturer before use. Caution should be taken when using Li-Po batteries in wet conditions.
- Most transmitters are not water-resistant. Consult your transmitter’s manual or the manufacturer before operation.
- Never operate your transmitter or vehicle where lightning may be present.
- Do not operate your vehicle where it could come in contact with salt water (ocean water or water on salt-covered roads), contaminated or polluted water. Salt water is very conductive and highly corrosive, so use caution.
- Even minimal water contact can reduce the life of your motor if it has not been certified as water-resistant or waterproof. If the motor becomes excessively wet, apply very light throttle until the water is mostly removed from the motor. Running a wet motor at high speeds may rapidly damage the motor.
- Driving in wet conditions can reduce the life of the motor. The additional resistance of operating in water causes excess strain. Alter the gear ratio by using a smaller pinion or larger spur gear. This will increase torque (and motor life) when running in mud, deeper puddles, or any wet conditions that will increase the load on the motor for an extended period of time.

### WET CONDITIONS MAINTENANCE

- Drain any water that has collected in the tires by spinning them at high speed. With the body removed, place the vehicle upside down and pull full throttle for a few short bursts until the water has been removed.

 **CAUTION:** Always keep hands, fingers, tools and any loose or hanging objects away from rotating parts when performing the above drying technique.

- Remove the battery pack(s) and dry the contacts. If you have an air compressor or a can of compressed air, blow out any water that may be inside the recessed connector housing.
- Remove the tires/wheels from the vehicle and gently rinse the mud and dirt off with a garden hose. Avoid rinsing the bearings and transmission.

**NOTICE:** Never use a pressure washer to clean your vehicle.

- Use an air compressor or a can of compressed air to dry the vehicle and help remove any water that may have gotten into small crevices or corners.
- Spray the bearings, drive train, fasteners and other metal parts with a water-displacing light oil. Do not spray the motor.
- Let the vehicle air dry before you store it. Water (and oil) may continue to drip for a few hours.
- Increase the frequency of disassembly, inspection and lubrication of the following:
  - Front and rear axle hub assembly bearings.
  - All transmission cases, gears and differentials.
  - Motor—clean with an aerosol motor cleaner and re-oil the bushings with lightweight motor oil.

## BOX CONTENTS

- Spektrum™ STX2® 2.4GHz Transmitter (SPMSTX200)
- Wraith 1.9 RTR
  - 35T Electric Motor (AX31312)
  - SRX200 2CH Receiver (SPMSRX200)
  - TSX45 High-Torque Metal Gear Dual Ball Bearing Servo (TACM0245)
  - AE-5L ESC w/LED Ports and Lights (DYNS2213)
  - AE-5L LED Light Set (AX31481)

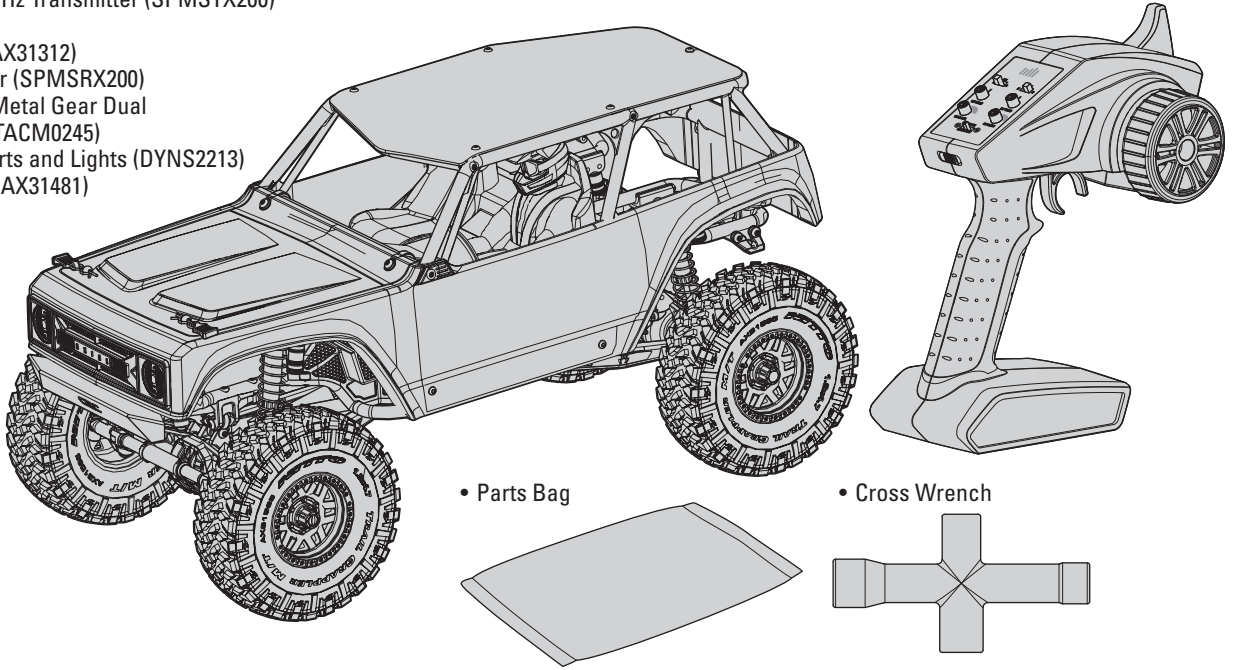

• Parts Bag

• Cross Wrench

## REQUIRED EQUIPMENT

- (4) AA Alkaline batteries
- 2-3S LiPo Battery  
**OR**  
• 5-9 Cell NiMH/NiCd battery  
(IC3™ Connector Required)
- Battery charger compatible with the chosen vehicle battery type

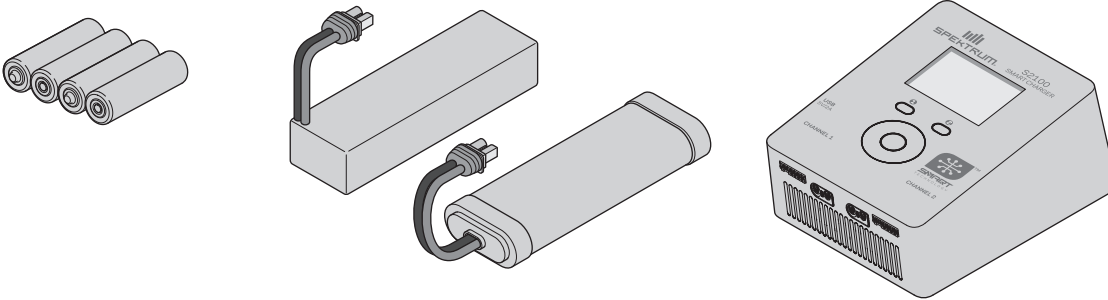

## RECOMMENDED TOOLS

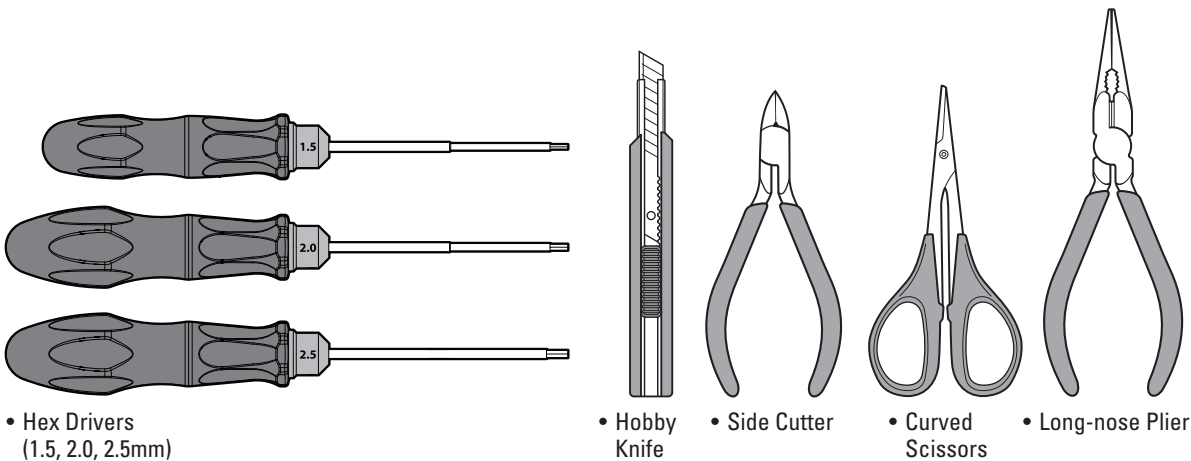

• Hex Drivers  
(1.5, 2.0, 2.5mm)

• Hobby Knife

• Side Cutter

• Curved Scissors

• Long-nose Plier



## GETTING STARTED CHECKLIST

Read the manual
Familiarize yourself with the vehicle and its components
Check all screws, especially the driveshaft setscrews, for tightness from the factory
Charge the vehicle battery
Install 4 AA batteries in the transmitter

Power on the transmitter
Install the vehicle battery in the vehicle
Check for proper function of the throttle and steering
Range check the radio system
Drive the vehicle, challenge yourself and have FUN!
Perform any necessary vehicle maintenance

## VEHICLE PARTS

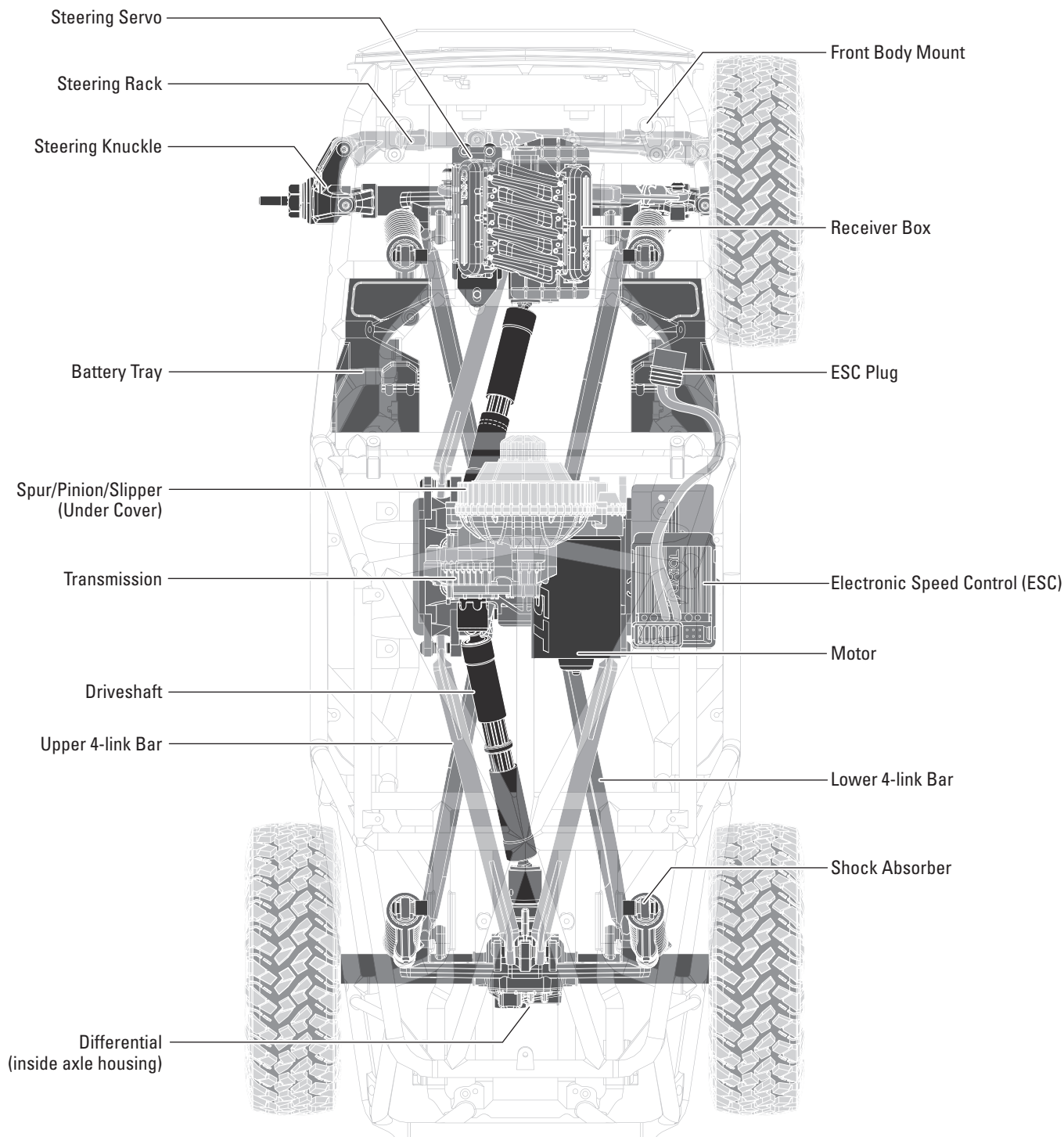

## CHARGE THE VEHICLE BATTERY

Follow the manufacturer's directions for your charger to properly charge the vehicle battery.

**CAUTION:** Only use chargers designed to charge the chosen battery type. Using an incorrect charger or incorrect charger settings could cause the battery to catch fire or explode.

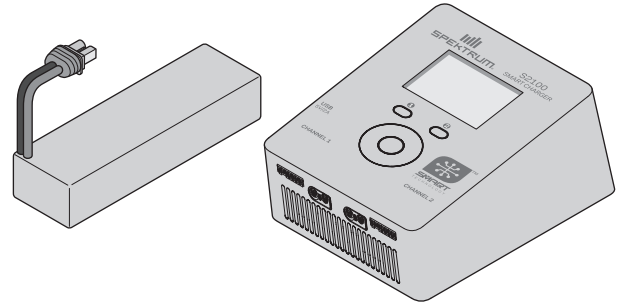

## INSTALL THE TRANSMITTER BATTERIES

This transmitter requires 4 AA batteries.

1. Remove the battery cover from the transmitter.
2. Install the batteries as shown.
3. Install the battery cover.

**CAUTION:** NEVER remove the transmitter batteries while the model is powered on. Loss of model control, damage, or injury may occur.

**CAUTION:** If using rechargeable batteries, charge only rechargeable batteries. Charging non-rechargeable batteries may cause the batteries to burst, resulting in injury to persons and/or damage to property.

**CAUTION:** Risk of explosion if battery is replaced by an incorrect type. Dispose of used batteries according to national regulations.

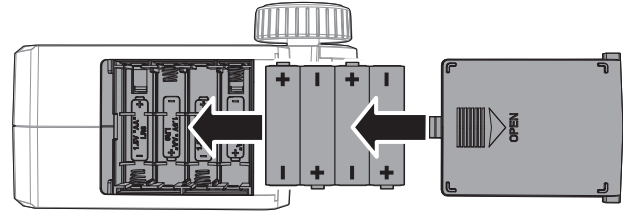

## TRANSMITTER FUNCTIONS

### A. Servo Reversing

To reverse the Throttle (TH) or Steering (ST) channel, switch the position of the correlating switch—"N" is for normal, "R" is for reverse.

### B. Throttle Trim

Adjusts the throttle neutral point

### C. Steering Trim

Adjusts the steering center point. Normally, the steering trim is adjusted until the vehicle tracks straight.

### D. Throttle Rate

Adjusts the end point of the throttle

### E. Steering Rate

Adjusts the end point of the steering

### F. Indicator Lights

- Solid red lights: Indicates radio connectivity and adequate battery power
- Flashing red lights: Indicates the battery voltage is critically low. Replace batteries

### G. Throttle Limit

Limits throttle output to 50/75/100%

Select 50% or 75% for less experienced drivers or when you are driving the vehicle in a small area.

### H. Antenna

### I. Power Button

### J. Throttle/Brake

### K. Steering Wheel

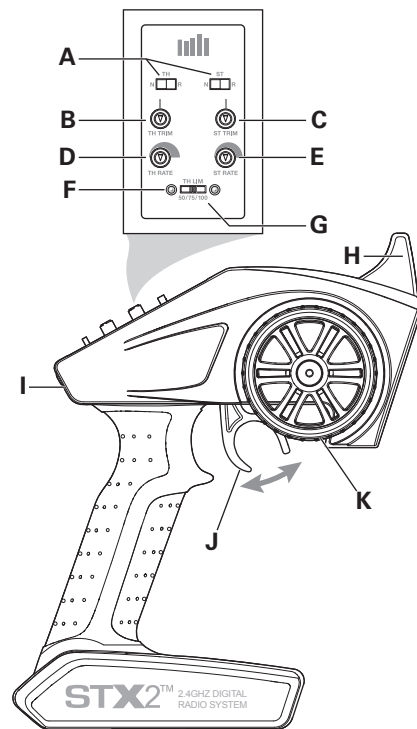



## INSTALL THE VEHICLE BATTERY

**NOTICE:** Power to the vehicle is controlled by connecting and disconnecting the battery from the ESC. Always power on the transmitter first before connecting the vehicle battery. Always disconnect the battery from the ESC when not in use.

1. Power on the transmitter.

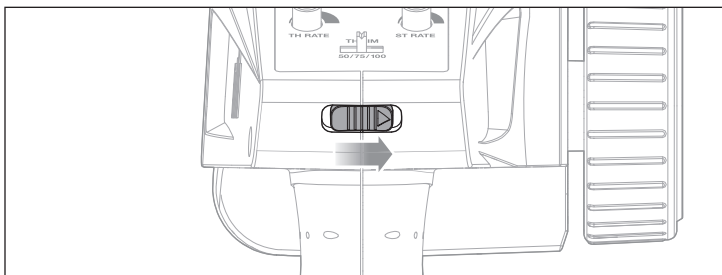

2. Remove the body clips and open the hood.

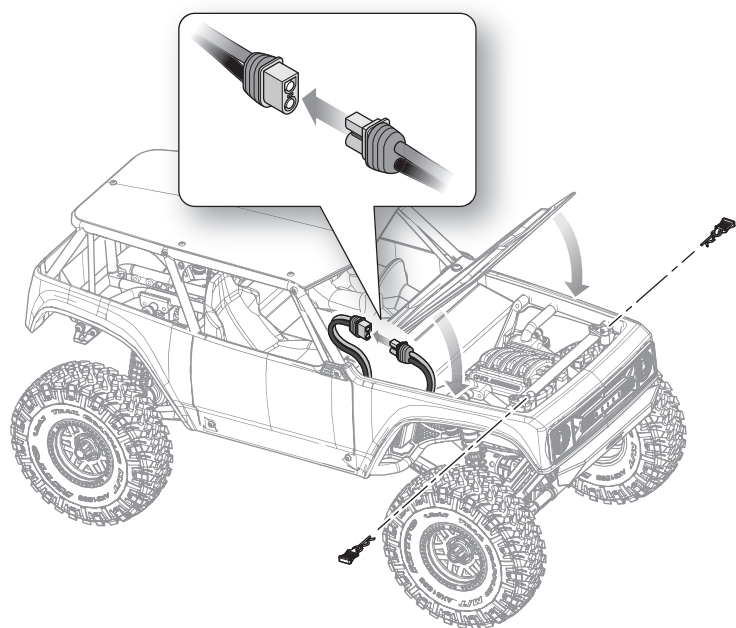
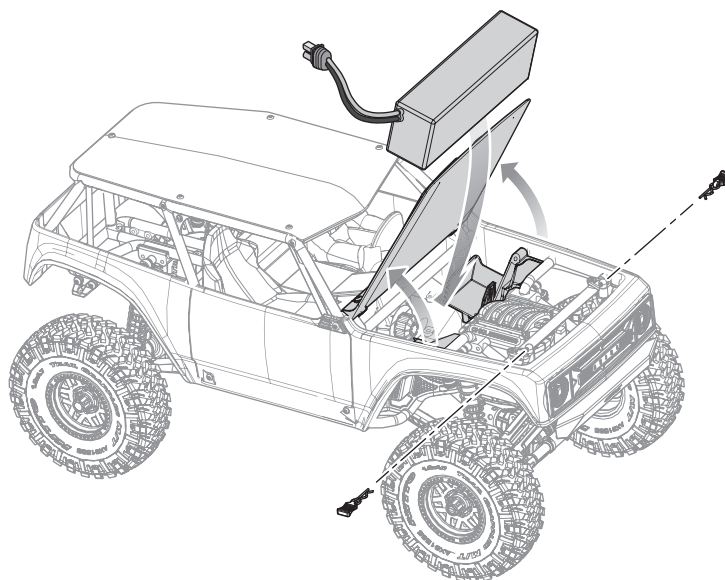

3. Connect the battery to the ESC. Close the hood and replace the body clips.

**NOTICE:** Always disconnect the battery from the ESC before powering off the transmitter. Loss of vehicle control may result.

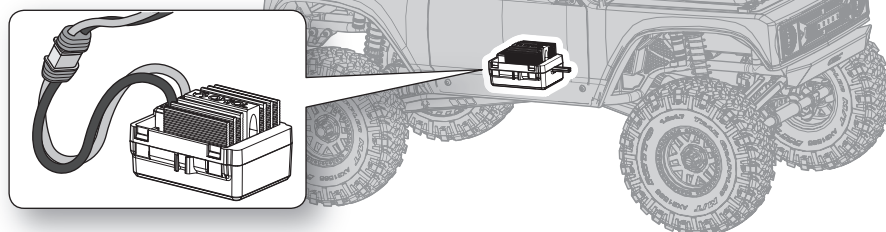

## BINDING

Binding is the process of programming the receiver to recognize the GUID (Globally Unique Identifier) code of a single specific transmitter. The STX2® transmitter and SPMSRX200 receiver are bound at the factory. If you need to rebind, follow the instructions below.

1. Insert the Bind Plug in the BIND port on the receiver.
2. Connect a fully charged battery pack to the ESC.
3. Power on the ESC. The red LED flashes, indicating the receiver is in bind mode.
4. Center the ST TRIM and TH TRIM dials on the transmitter.
5. Turn the steering wheel to Full Right. Power the transmitter on while holding the steering wheel to the Right.
6. Release the steering wheel when the receiver LED stops flashing.
7. Remove the Bind Plug, then power off the receiver to save the settings.
8. Power off the transmitter.
9. Remove the bind plug and store it in a convenient place.

You must rebind when:

- Different failsafe positions are desired e.g., when throttle or steering reversing has been changed.
- Binding the receiver to a different transmitter.

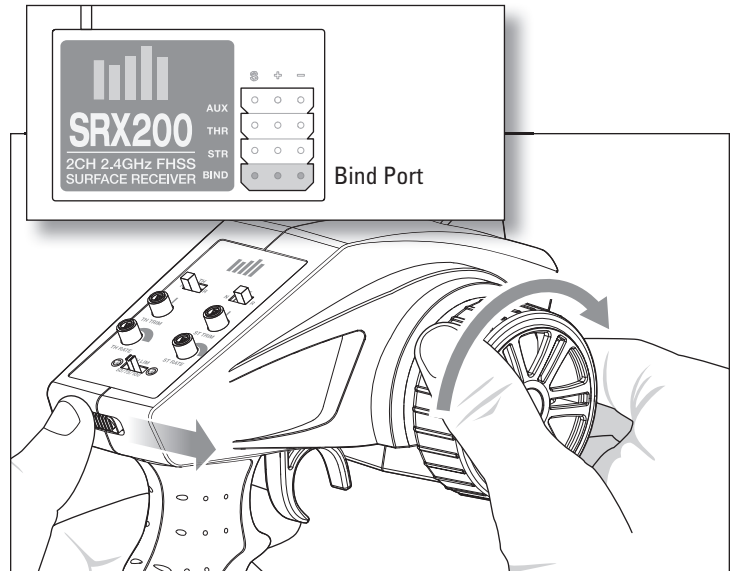

## RANGE-CHECKING THE RADIO SYSTEM

The radio system should be checked before operating the vehicle to ensure proper operation and adequate range.

1. Turn on the transmitter.
2. Connect the battery in the vehicle.
3. Have a friend hold the vehicle while keeping hands and loose clothing away from moving parts.
4. Walk away until you are at the maximum planned operating distance from the vehicle.
5. Turn the steering wheel side to side and operate the throttle, both forward and reverse, checking for any erratic behavior.
6. If any erratic behavior is exhibited, DO NOT operate the vehicle. Call customer service for assistance.





## VEHICLE MAINTENANCE

Just like a full size car or truck your RC vehicle must undergo periodic maintenance in order to ensure peak performance. Preventative maintenance will also help avoid needless breakages which could result in costly repairs. Below are some suggestions to properly maintain your vehicle.

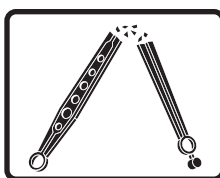
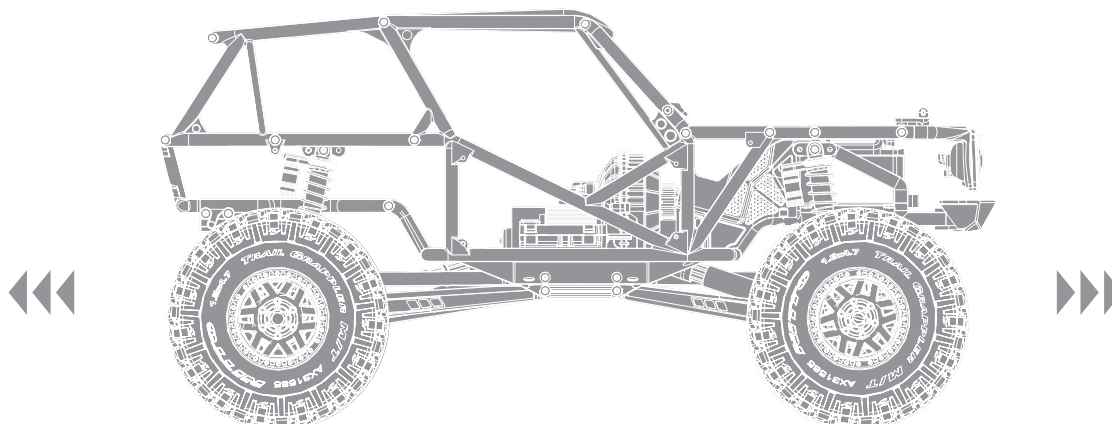

Replace any noticeable bent or broken parts

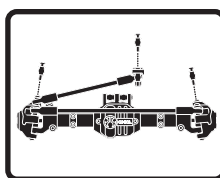

Check for wear on the ball joints in the steering and suspension links (replace if necessary)

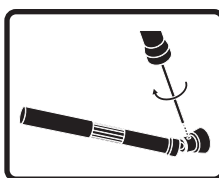

Check driveshaft set screws and apply thread locking compound if necessary

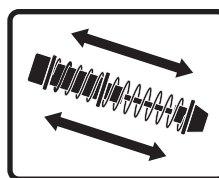

Inspect shock absorbers for smooth dampened operation

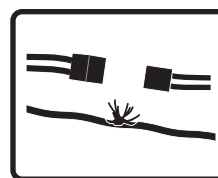

Check for any loose connections or frayed wiring

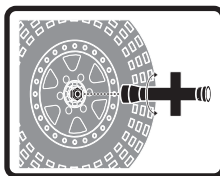

Check the wheel nuts for tightness

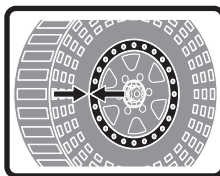

Ensure the wheel beads are still firmly bonded around the entire circumference of the rim

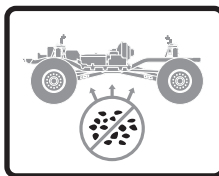

Keep the chassis free of dirt and debris

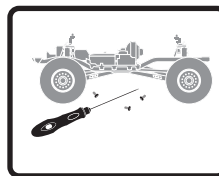

Check for loose screws on the chassis, especially the knuckle, C-hub and axle lockout screws

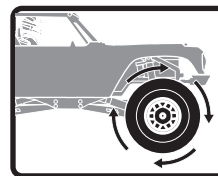

Check the driveline for smooth, bind free operation

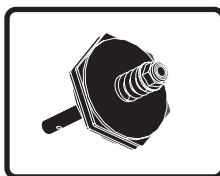

If applicable, check the slipper clutch for proper operation

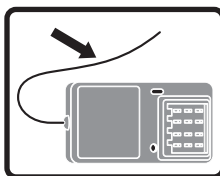

Check the receiver antenna for damage

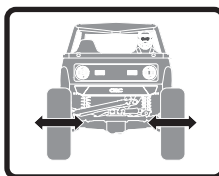

Check the steering operation for any binding

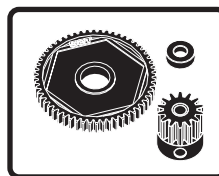

Inspect the spur and pinion gears for damage

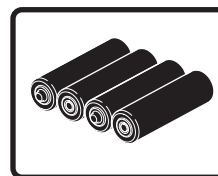

Replace the transmitter batteries when indicated by the transmitter, as described in the Transmitter Functions section

## ADJUSTING THE BATTERY TRAY

M3x8mm (x4)

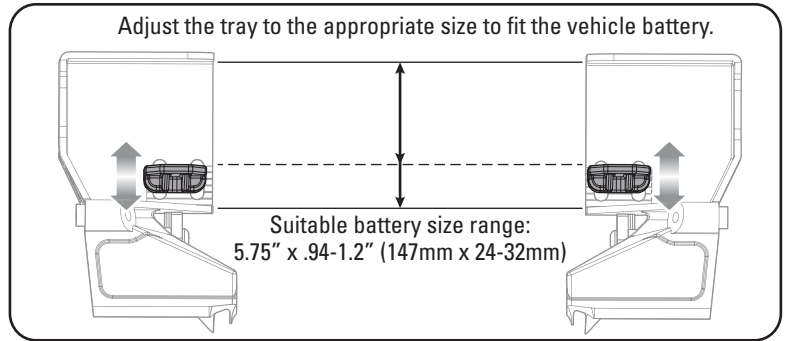
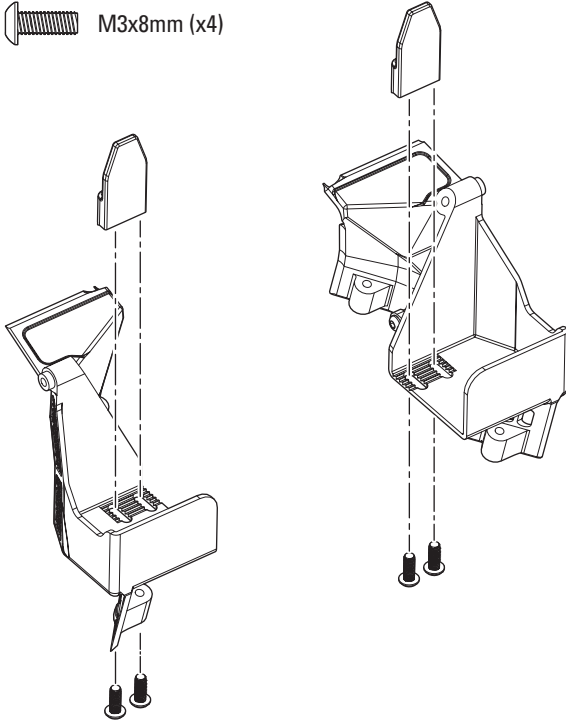

## AE-5L FORWARD/REVERSE ESC WITH DRAG BRAKE

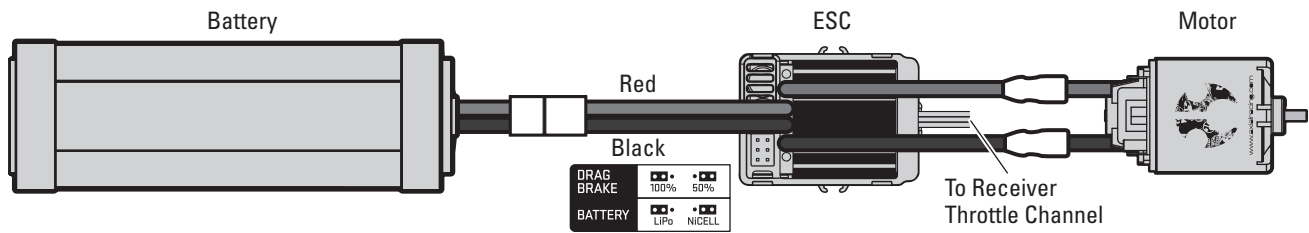

### SETUP

Throttle calibration should not be needed out of the box. However, in order to make the throttle range of different transmitters, the calibration of the ESC is necessary:

- Mount the ESC in an area that is well ventilated and isolated from vibration and shock.
- Connect the ESC motor wires to the motor red-to-red and black-to-black.
- Plug the receiver into the throttle channel of the receiver.
- Before plugging the battery into the ESC, make sure your transmitter is on and the throttle trim is set to zero.
- Connect the battery to the ESC. The vehicle will be powered on when the battery is connected.

**CAUTION:** Keep all body parts and loose clothing away from any moving parts while the battery is connected to the ESC.

**CAUTION:** Always connect the ESC only to a proper power source that has the correct voltage and polarity. Incorrect voltages or reversed polarity will damage the ESC. Damage to the ESC caused by improper voltage or polarity is not covered under warranty.

- Test forward and reverse control using the transmitter.

To calibrate the ESC:

- Power the transmitter on and set the throttle control to neutral.
- Connect the battery to the ESC and wait 3 seconds to let the ESC initiate a self-test and automatic throttle calibration.
- The ESC is ready to run when a long beep sound is emitted from the motor.
- Always disconnect the battery when the vehicle is not in use.

### NOTES

- The drag brake is set to 100% from the factory.
- The LiPo cut-off is set to "ON" from the factory.

### ESC SPECIFICATIONS

<b>Input Voltage</b>	2-3S LiPo, 5-9 Cells NiMH/NiCd
<b>Size</b>	46.5mm x 34mm x 28.5mm
<b>Weight</b>	70g
<b>Motor Limit</b>	12T 2S/18T 3S
<b>On-Resistance FET</b>	.002
<b>Rated/Peak Current</b>	180A
<b>Braking Current</b>	90A
<b>BEC Voltage/A</b>	6.0V 3.0A Peak
<b>PWM Frequency</b>	1KHz

### ESC SOUND STATUS

<b>1 Short Beep</b>	Battery is NiMH/NiCd
<b>2 Short Beeps</b>	Battery is 2S LiPo
<b>3 Short Beeps</b>	Battery is 3S LiPo
<b>1 Long Beep</b>	Self-test and throttle calibration is OK and ESC is ready to run



## GEAR RATIOS

Spur/Pinion Gear Ratio Chart - LCX Transmission

	12	13	14	15	16	17	18
56	45.50	42.00	39.00	36.40	34.13	32.12	30.33
60	48.75	45.00	41.79	39.00	36.56		

## TROUBLESHOOTING

PROBLEM	POSSIBLE CAUSE	SOLUTION
Vehicle does not move	Batteries are not installed properly in the transmitter	Ensure the transmitter batteries are properly installed
	Weak or no battery in the vehicle	Install a freshly charged vehicle battery
	Damaged motor	Replace the motor
	Frayed or broken wiring	Replace any damaged wiring
	ESC is shut down by heat protection circuit	Allow the ESC to cool down completely
Loss of vehicle control	Improper antenna placement	Ensure the transmitter antenna is not blocked and the receiver antenna is located properly
	Weak or no batteries in the transmitter or vehicle	Install a freshly charged vehicle battery and new transmitter batteries
	Neutral or trim position is incorrect	Adjust the steering trim
	Receiver and/or battery not connected properly	Check all receiver and battery connections
Steering and/or throttle function is reversed	Servo travel is reversed at the transmitter	Set the transmitter servo reversing switch to the correct position
	Motor wires are not connected properly	Check all motor wires for correct polarity and secure connection

## NOTES

## LIMITED WARRANTY

### What this Warranty Covers

Horizon Hobby, LLC, (Horizon) warrants to the original purchaser that the product purchased (the "Product") will be free from defects in materials and workmanship at the date of purchase.

### What is Not Covered

This warranty is not transferable and does not cover (i) cosmetic damage, (ii) damage due to acts of God, accident, misuse, abuse, negligence, commercial use, or due to improper use, installation, operation or maintenance, (iii) modification of or to any part of the Product, (iv) attempted service by anyone other than a Horizon Hobby authorized service center, (v) Product not purchased from an authorized Horizon dealer, or (vi) Product not compliant with applicable technical regulations or (vii) use that violates any applicable laws, rules, or regulations.

OTHER THAN THE EXPRESS WARRANTY ABOVE, HORIZON MAKES NO OTHER WARRANTY OR REPRESENTATION, AND HEREBY DISCLAIMS ANY AND ALL IMPLIED WARRANTIES, INCLUDING, WITHOUT LIMITATION, THE IMPLIED WARRANTIES OF NON-INFRINGEMENT, MERCHANTABILITY AND FITNESS FOR A PARTICULAR PURPOSE. THE PURCHASER ACKNOWLEDGES THAT THEY ALONE HAVE DETERMINED THAT THE PRODUCT WILL SUITABLY MEET THE REQUIREMENTS OF THE PURCHASER'S INTENDED USE.

### Purchaser's Remedy

Horizon's sole obligation and purchaser's sole and exclusive remedy shall be that Horizon will, at its option, either (i) service, or (ii) replace, any Product determined by Horizon to be defective. Horizon reserves the right to inspect any and all Product(s) involved in a warranty claim. Service or replacement decisions are at the sole discretion of Horizon. Proof of purchase is required for all warranty claims. SERVICE OR REPLACEMENT AS PROVIDED UNDER THIS WARRANTY IS THE PURCHASER'S SOLE AND EXCLUSIVE REMEDY.

### Limitation of Liability

HORIZON SHALL NOT BE LIABLE FOR SPECIAL, INDIRECT, INCIDENTAL OR CONSEQUENTIAL DAMAGES, LOSS OF PROFITS OR PRODUCTION OR COMMERCIAL LOSS IN ANY WAY, REGARDLESS OF WHETHER SUCH CLAIM IS BASED IN CONTRACT, WARRANTY, TORT, NEGLIGENCE, STRICT LIABILITY OR ANY OTHER THEORY OF LIABILITY, EVEN IF HORIZON HAS BEEN ADVISED OF THE POSSIBILITY OF SUCH DAMAGES. Further, in no event shall the liability of Horizon exceed the individual price of the Product on which liability is asserted. As Horizon has no control over use, setup, final assembly, modification or misuse, no liability shall be assumed nor accepted for any resulting damage or injury. By the act of use, setup or assembly, the user accepts all resulting liability. If you as the purchaser or user are not prepared to accept the liability associated with the use of the Product, purchaser is advised to return the Product immediately in new and unused condition to the place of purchase.

### Law

These terms are governed by Illinois law (without regard to conflict of law principals). This warranty gives you specific legal rights, and you may also have other rights which vary from state to state. Horizon reserves the right to change or modify this warranty at any time without notice.

### WARRANTY SERVICES

#### Questions, Assistance, and Services

Your local hobby store and/or place of purchase cannot provide warranty support or service. Once assembly, setup or use of the Product has been started, you must contact your local distributor or Horizon directly. This will enable Horizon to better answer your questions and service you in the event that you may need any assistance. For questions or assistance,

please visit our website at [www.horizonhobby.com](http://www.horizonhobby.com), submit a Product Support Inquiry, or call the toll free telephone number referenced in the Warranty and Service Contact Information section to speak with a Product Support representative.

### Inspection or Services

If this Product needs to be inspected or serviced and is compliant in the country you live and use the Product in, please use the Horizon Online Service Request submission process found on our website or call Horizon to obtain a Return Merchandise Authorization (RMA) number. Pack the Product securely using a shipping carton. Please note that original boxes may be included, but are not designed to withstand the rigors of shipping without additional protection. Ship via a carrier that provides tracking and insurance for lost or damaged parcels, as Horizon is not responsible for merchandise until it arrives and is accepted at our facility. An Online Service Request is available at [http://www.horizonhobby.com/content/service-center\\_render-service-center](http://www.horizonhobby.com/content/service-center_render-service-center). If you do not have internet access, please contact Horizon Product Support to obtain a RMA number along with instructions for submitting your product for service. When calling Horizon, you will be asked to provide your complete name, street address, email address and phone number where you can be reached during business hours. When sending product into Horizon, please include your RMA number, a list of the included items, and a brief summary of the problem. A copy of your original sales receipt must be included for warranty consideration. Be sure your name, address, and RMA number are clearly written on the outside of the shipping carton.

**NOTICE:** Do not ship Li-Po batteries to Horizon. If you have any issue with a Li-Po battery, please contact the appropriate Horizon Product Support office.

### Warranty Requirements

For Warranty consideration, you must include your original sales receipt verifying the proof-of-purchase date. Provided warranty conditions have been met, your Product will be serviced or replaced free of charge. Service or replacement decisions are at the sole discretion of Horizon.

### Non-Warranty Service

Should your service not be covered by warranty, service will be completed and payment will be required without notification or estimate of the expense unless the expense exceeds 50% of the retail purchase cost. By submitting the item for service you are agreeing to payment of the service without notification. Service estimates are available upon request. You must include this request with your item submitted for service. Non-warranty service estimates will be billed a minimum of 1/2 hour of labor. In addition you will be billed for return freight. Horizon accepts money orders and cashier's checks, as well as Visa, MasterCard, American Express, and Discover cards. By submitting any item to Horizon for service, you are agreeing to Horizon's Terms and Conditions found on our website [http://www.horizonhobby.com/content/service-center\\_render-service-center](http://www.horizonhobby.com/content/service-center_render-service-center).

**ATTENTION:** Horizon service is limited to Product compliant in the country of use and ownership. If received, a non-compliant Product will not be serviced. Further, the sender will be responsible for arranging return shipment of the un-serviced Product, through a carrier of the sender's choice and at the sender's expense. Horizon will hold non-compliant Product for a period of 60 days from notification, after which it will be discarded.

10/15

## WARRANTY AND SERVICE CONTACT INFORMATION

Country of Purchase	Horizon Hobby	Contact Information	Address
United States of America	Horizon Service Center (Repairs and Repair Requests)	<a href="http://servicecenter.horizonhobby.com/RequestForm/">servicecenter.horizonhobby.com/RequestForm/</a>	2904 Research Rd Champaign, IL 61822
	Horizon Product Support (Product Technical Assistance)	<a href="mailto:productsupport@horizonhobby.com">productsupport@horizonhobby.com</a> 877-504-0233	
	Sales	<a href="mailto:websales@horizonhobby.com">websales@horizonhobby.com</a> 800-338-4639	
European Union	Horizon Technischer Service	<a href="mailto:service@horizonhobby.eu">service@horizonhobby.eu</a>	Hanskampring 9 D 22885 Barsbüttel, Germany
	Sales: Horizon Hobby GmbH	+49 (0) 4121 2655 100	

## FCC INFORMATION

### FCC ID: 2AI3D-SS0001

This device complies with part 15 of the FCC rules. Operation is subject to the following two conditions: (1) This device may not cause harmful interference, and (2) this device must accept any interference received, including interference that may cause undesired operation.

**CAUTION:** Changes or modifications not expressly approved by the party responsible for compliance could void the user's authority to operate the equipment.

This product contains a radio transmitter with wireless technology which has been tested and found to be compliant with the applicable regulations governing a radio transmitter in the 2.400GHz to 2.4835GHz frequency range.

### SUPPLIER'S DECLARATION OF CONFORMITY

#### Axial Wraith 1.9 (AXI90074)

**FCC** This device complies with part 15 of the FCC Rules. Operation is subject to the following two conditions: (1) This device may not cause harmful interference, and (2) this device must accept any interference received, including interference that may cause undesired operation.

**CAUTION:** changes or modifications not expressly approved by the party responsible for compliance could void the user's authority to operate the equipment.

**NOTE:** This equipment has been tested and found to comply with the limits for a Class B digital device, pursuant to part 15 of the FCC Rules. These limits are designed to provide reasonable protection against harmful interference in a residential installation. This equipment generates, uses and can radiate radio frequency energy and, if not installed and used in accordance with the instructions, may cause harmful interference to radio communications. However, there is no guarantee that interference will not occur in a particular installation. If this equipment does cause harmful interference to radio or television reception, which can be determined by turning the equipment off and on, the user is encouraged to try to correct the interference by one or more of the following measures:

- Reorient or relocate the receiving antenna.
- Increase the separation between the equipment and receiver.
- Connect the equipment into an outlet on a circuit different from that to which the receiver is connected.
- Consult the dealer or an experienced radio/TV technician for help.

Horizon Hobby, LLC  
4105 Fieldstone Rd.,  
Champaign, IL 61822  
Email: [compliance@horizonhobby.com](mailto:compliance@horizonhobby.com)  
Web: [HorizonHobby.com](http://HorizonHobby.com)

## IC INFORMATION

### CAN ICES-3 (B)/NMB-3(B)

#### IC: 21682-SSTC9202

This device complies with Industry Canada licence-exempt RSS standard(s). Operation is subject to the following two conditions:

(1) this device may not cause interference, and (2) this device must accept any interference, including interference that may cause undesired operation of the device.

## COMPLIANCE INFORMATION FOR THE EUROPEAN UNION



### EU COMPLIANCE STATEMENT:

#### Axial Wraith 1.9 (AXI90074)

Horizon Hobby, LLC hereby declares that this product is in compliance with the essential requirements and other relevant provisions of the RED and EMC Directives.

A copy of the EU Declaration of Conformity is available online at: <http://www.horizonhobby.com/content/support-render-compliance>.

### INSTRUCTIONS FOR DISPOSAL OF WEEE BY USERS IN THE EUROPEAN UNION



This product must not be disposed of with other waste. Instead, it is the user's responsibility to dispose of their waste equipment by handing it over to a designated collection point for the recycling of waste electrical and electronic equipment. The separate collection and recycling of your waste equipment at the time of disposal will help to conserve natural resources and ensure that it is recycled in a manner that protects human health and the environment. For more information about where you can drop off your waste equipment for recycling, please contact your local city office, your household waste disposal service or where you purchased the product.



E328

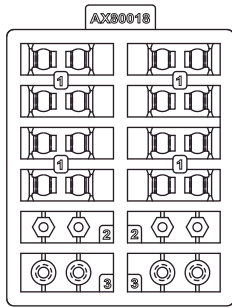

**AX80018 (x2)**  
Hardware parts tree  
Hardware-Teilebaum  
Arbre des pièces de quincaillerie  
Set bulloneria

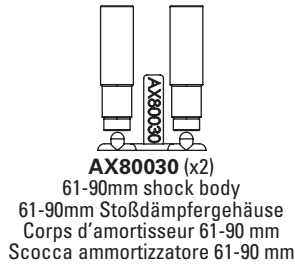

**AX80030 (x2)**  
61-90mm shock body  
61-90mm Stoßdämpfergehäuse  
Corps d'amortisseur 61-90 mm  
Scocca ammortizzatore 61-90 mm

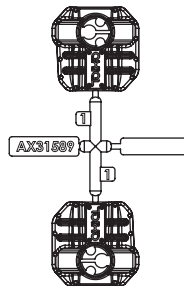

**AX31589 (x1)**  
AR44 Differential Covers (red)  
AR44 Differenzialgehäuse (rot)  
Couvercles de différentiel AR44 (rouge)  
Carter differenziale AR44 (rosso)

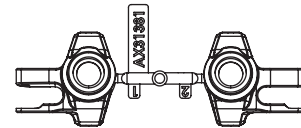

**AX31381 (x1)**  
AR44 Steering knuckles  
AR44 Lenkrollen  
Rotules de direction AR44  
Fuso a snodo AR44

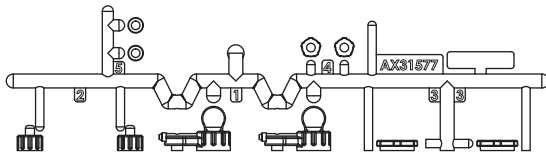

**AX31577 (x2)**  
Shock cap parts tree  
Stoßdämpferkappe Teilebaum  
Arbre des pièces de capuchons d'amortisseurs  
Set tappi ammortizzatore

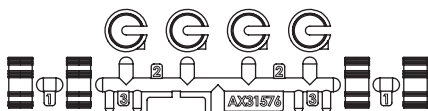

**AX31574 (x1)**  
AR44 Solid axle housing, front and rear  
AR44 solides Achsgehäuse, vorne und hinten  
Carter d'essieu solide AR44, avant et arrière  
Alloggiamento solido assale AR44, anteriore e posteriore

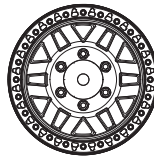

**AX143001 (x4)**  
11.9 KMC Machete wheel 26mm, satin chrome  
11.9 KMC Macheten-Rad 26 mm, matt verchromt  
Roue Machete 11.9 KMC, 26 mm, chrome satiné  
Ruota 11.9 KMC Machete 26 mm, cromo satinato

**AX31576 (x1)**  
10mm shock parts tree  
10 mm Stoßdämpfer-Teilebaum  
Arbre des pièces d'amortisseurs 10 mm  
Set ricambi per ammortizzatore 10 mm

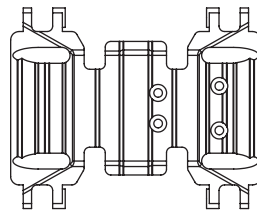

**AX1231001 (x1)**  
Wraith 1.9 skid plate  
Wraith 1.9 Gleitbrett  
Plaque de protection Wraith 1.9  
Piastra di protezione Wraith 1.9

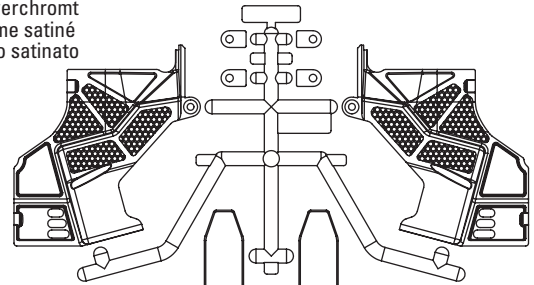

**AX1231001 (x1)**  
Wraith 1.9 battery tray  
Wraith 1.9 Akkuhalterung  
Support de batterie Wraith 1.9  
Vassoio portabatteria Wraith 1.9

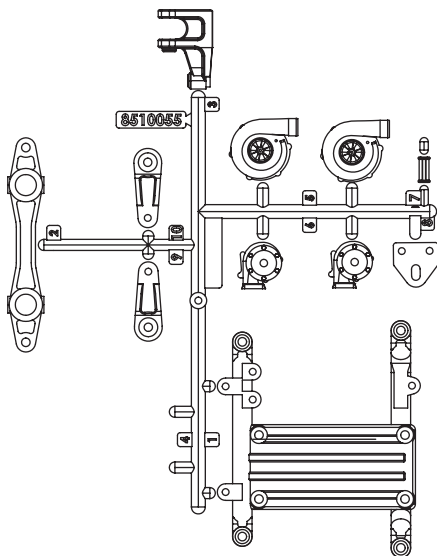

**AX1231002 (x1)**  
Wraith 1.9 receiver box parts tree  
Wraith 1.9 Empfängerbox Teilebaum  
Arbre des pièces du boîtier de récepteur Wraith 1.9  
Set ricambi vano ricevitore Wraith 1.9

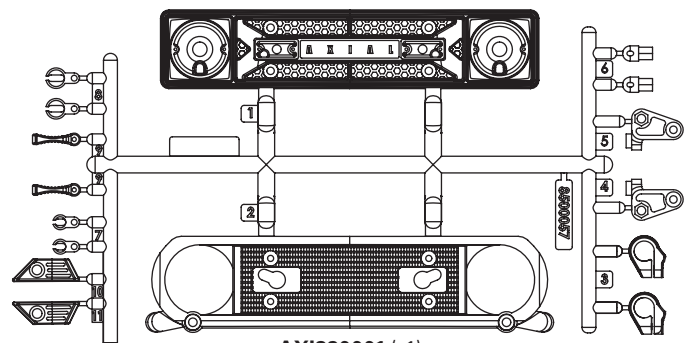

**AX1230001 (x1)**  
Wraith 1.9 grille set  
Wraith 1.9 Kühlergrillset  
Ensemble de calandre Wraith 1.9  
Set griglia Wraith 1.9



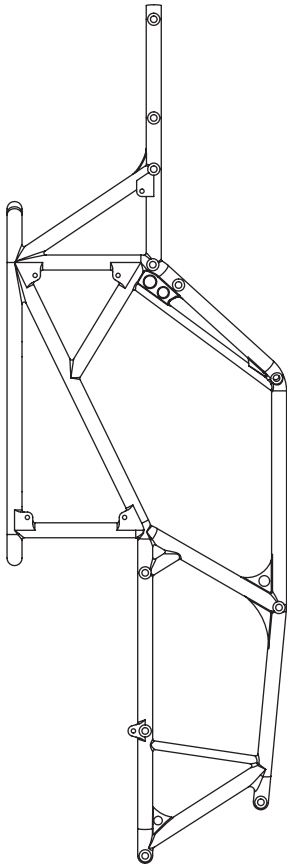

**AX80087** (x1)  
 Rock buggy main frame  
 Rock-Buggy-Hauptrahmen  
 Châssis principal Rock Buggy  
 Telaio principale Rock buggy

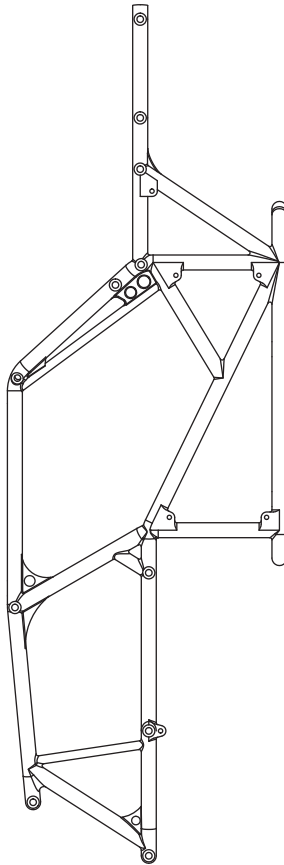

**AX80088** (x1)  
 Rock buggy main frame  
 Rock-Buggy-Hauptrahmen  
 Châssis principal Rock Buggy  
 Telaio principale Rock buggy

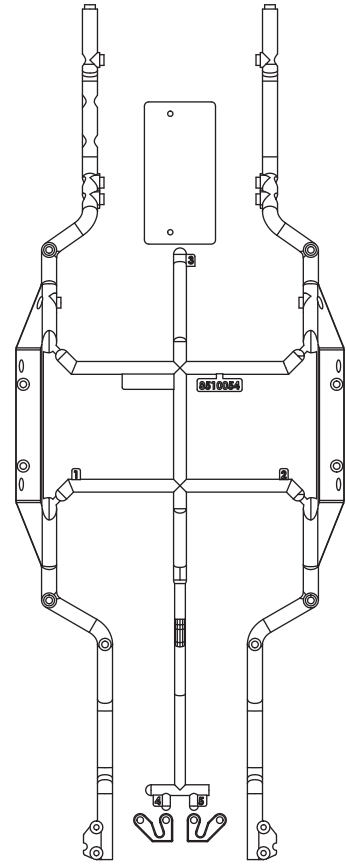

**AXI231001** (x1)  
 Wraith 1.9 lower rails  
 Wraith 1.9 untere Schienen  
 Rails inférieures Wraith 1.9  
 Guide inferiori Wraith 1.9

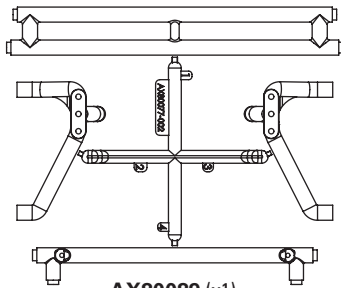

**AX80089** (x1)  
 Rock buggy front end 2  
 Rock-Buggy-Front 2  
 Train avant Rock Buggy 2  
 Parte anteriore Rock buggy 2

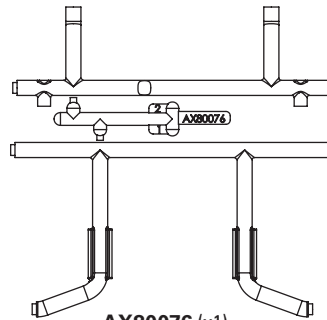

**AX80076** (x1)  
 Rock buggy rear brace set  
 Hinteres Rock-Buggy-Stützenset  
 Ensemble de support arrière Rock Buggy  
 Set bretella posteriore Rock buggy

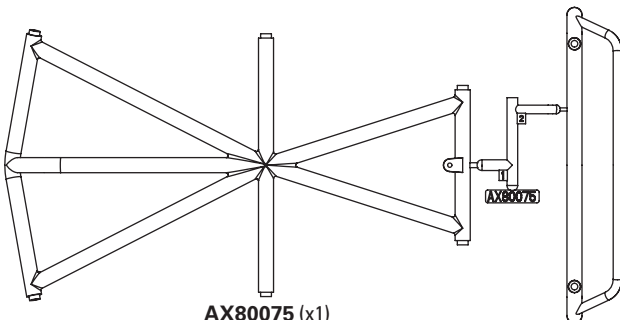

**AX80075** (x1)  
 Wraith tube frame, top  
 Wraith Rohrgestell, oben  
 Châssis tubulaire Wraith, haut  
 Telaio tubolare Wraith, parte superiore

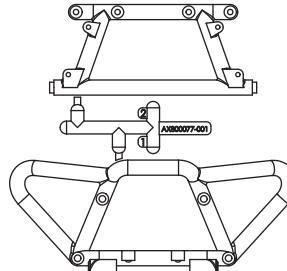

**AX80077-01** (x1)  
 Rock buggy front end 1  
 Rock-Buggy-Front 1  
 Train avant du Rock Buggy 1  
 Parte anteriore Rock buggy 1

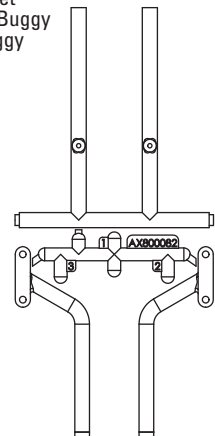

**AX80082** (x1)  
 Rock buggy battery brace  
 Rock-Buggy-Akku-Halterung  
 Support de batterie Rock Buggy  
 Supporto batteria Rock buggy

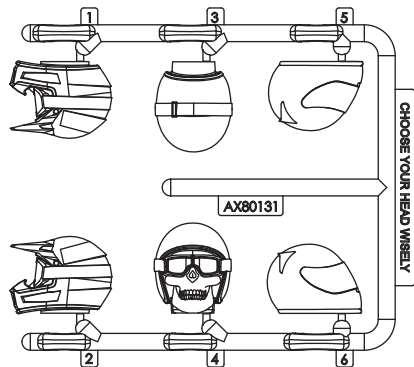

**AX31049** (x1)  
 Helmet set, black  
 Helm-Set, schwarz  
 Ensemble de casque, noir  
 Set elmetti, nero

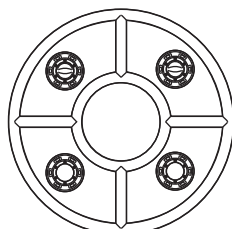

**AX8080** (x1)  
 Hub cover set, satin chrome  
 Nabenabdeckungsset, matt verchromt  
 Ensemble de caches de moyeu, chrome satiné  
 Set coprimozzo, cromo satinato

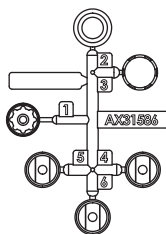

**AX31586** (x2)  
 WB8-HD Standard driveshaft  
 WB8-HD Standard-Antriebswelle  
 Arbre de transmission standard WB8-HD  
 Albero di trasmissione standard WB8-HD

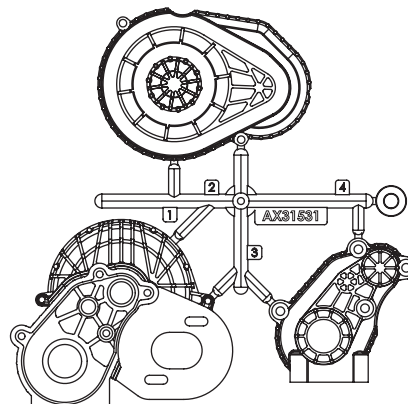

**AX31531** (x2)  
 LCX Transmission case, silver  
 LCX Getriebeabdeckung, silber  
 Boîtier de transmission LCX, argenté  
 Scatola del cambio LCX, argento

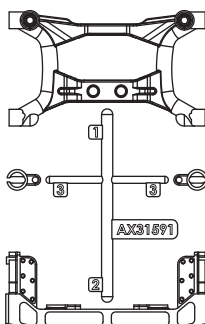

**AX31591** (x1)  
 Chassis Brace set  
 Karosseriestrebensatz  
 Ensemble de support de carrosserie  
 Set bretella telaio

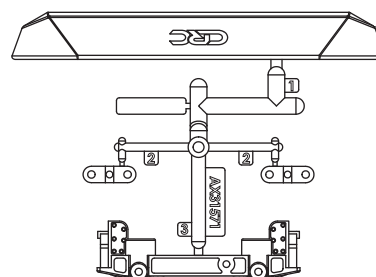

**AX31571** (x1)  
 CRC JK Front bumper  
 CRC JK Frontstoßstange  
 Pare-chocs avant CRC JK  
 Paraurti anteriore CRC JK

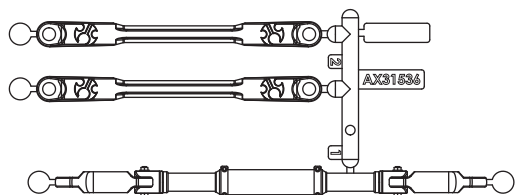

**AX31536** (x1)  
 SCX10 II Steering link  
 SCX10 II-Lenkstange  
 Tringlerie de direction SCX10 II  
 Collegamento sterzo SCX10 II

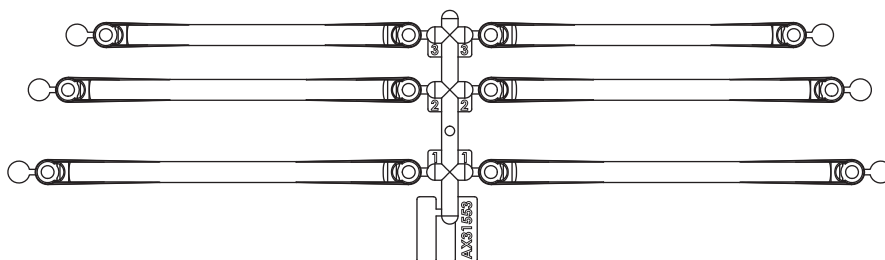

**AX31533** (x1)  
 SCX10 II Upper links set  
 SCX10 II oberes Verbindungsgliedset  
 Ensemble de timonerie supérieure SCX10 II  
 Set leveraggi, superiore SCX10 II

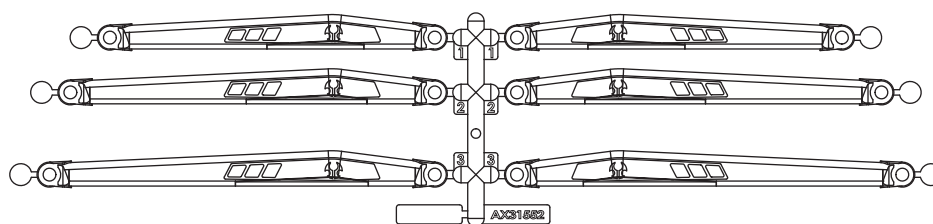

**AX31552** (x1)  
 SCX10 II Lower links set  
 SCX10 II unteres Verbindungsgliedset  
 Ensemble de timonerie inférieure SCX10 II  
 Set leveraggi, inferiore SCX10 II

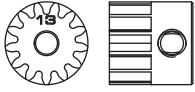

**AX30724** (x2)  
Pinion gear, 13T, 32P  
Zahnradgetriebe, 13T, 32P  
Engrenage à pignons, 13T, 32P  
Pignone, 13T, 32P

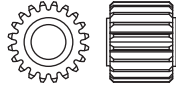

**AX30394** (x1)  
Drive gear, 20T  
Antriebszahnrad, 20T  
Engrenage d'entraînement, 20T  
Ingranaggio trasmissione, 20T

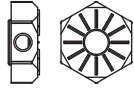

**AX30427** (x4)  
Narrow 12mm aluminum hub  
Schmale Aluminium-Nabe, 12 mm  
Moyeu étroit en aluminium de 12 mm  
Mozzo in alluminio stretto, 12 mm



**AX30413** (x1)  
Slipper spring, 8.5 x 12  
Gleitfeder, 8,5 x 12  
Ressort de sabot, 8,5 x 12  
Molla pattino, 8,5 x 12

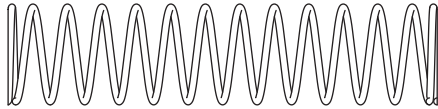

**AX31441** (x4)  
Spring, 12.5 x 60mm, 1.13 lbs, white  
Feder, 12,5 x 60 mm, 0,5 kg, weiß  
Ressort, 12,5 x 60 mm, 0,12 Nm (1,13 lb-po), blanc  
Molla, 12,5 x 60 mm, 512 gr (1,13 libbre), bianco

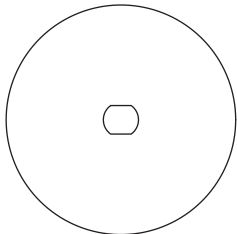

**AX31026** (x2)  
Slipper plate washer, 33 x 5 x 1.5mm  
Gleitplattenunterlegscheibe, 33 x 5 x 1,5 mm  
Rondelle de plaque de sabot, 33 x 5 x 1,5 mm  
Rondella piastra pattino, 33 x 5 x 1,5 mm

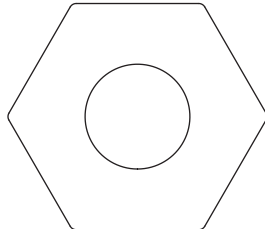

**AX31068** (x2)  
Slipper pad, 32.8 x 15.2 x 1mm  
Gleitkissen 32,8 x 15,2 x 1 mm  
Sabot de piston, 32,8 x 15,2 x 1 mm  
Pattino scorrevole, 32,8 x 15,2 x 1 mm

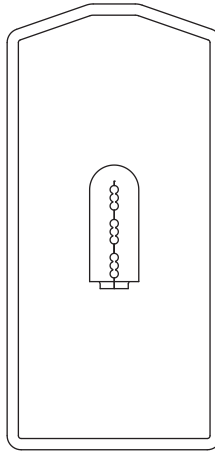

**AX31083** (x1)  
Radio box seals  
Funkbox-Dichtungen  
Joints du boîtier de radio  
Guarnizioni vano radiocomando

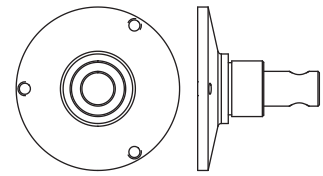

**AX30435** (x1)  
Steel outride shaft  
Stahl-Flexwelle  
Arbre de transmission extérieur en acier  
Albero outride acciaio

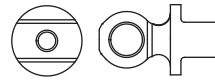
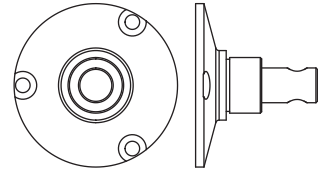

**AX31148** (x4)  
WB8-HD Driveshaft coupler set  
WB8-HD-Antriebswellenkupplungssatz  
Ensemble de couplage d'arbre de transmission WB8-HD  
Set accoppiamento albero trasmissione WB8-HD

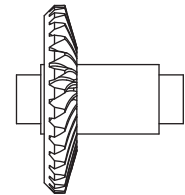

**AX31530** (x2)  
AR44 Locker bevel gear set, 30T/8T  
AR44 Kegelradgetriebebesatz, 30T/8T  
Ensemble d'engrenage conique de blocage AR44, 30T/8T  
Set coppia conica blocco AR44, 30T/8T

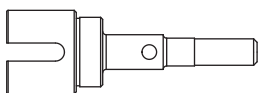
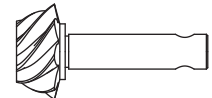

**AX31471** (x2)  
Axle, 12 x 36mm  
Achse, 12 x 36 mm  
Essieu, 12 x 36 mm  
Assale, 12 x 36 mm

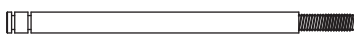

**AX30146** (x4)  
Shock shaft, 3 x 50mm  
Kolbenstange, 3 x 50 mm  
Bras d'amortisseur, 3 x 50 mm  
Albero ammortizzatore, 3 x 50 mm



**AX31539** (x1)  
Slipper drive gear shaft  
Gleittriebswelle  
Arbre d'engrenage d'entraînement du sabot  
Albero trasmissione pattino

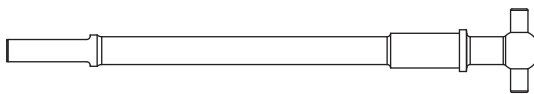

**AX31472** (x2)  
Solid Axle Dogbone, 6 x 73.5 mm  
Solid Axle Dogbone, 6 x 73,5 mm  
Dogbone d'essieu solide, 6 x 73,5 mm  
Dogbone assale solido, 6 x 73,5 mm



**AX31408** (x2)  
AR44 Straight axle shaft, 5 x 106mm  
AR44 Gerade Achswelle, 5 x 106 mm  
Arbre d'essieu droit AR44, 5 x 106 mm  
Semiasse lineare AR44, 5 x 106 mm

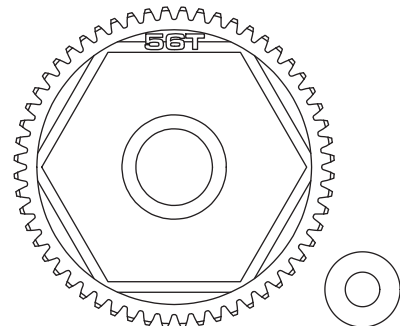

**AX31027** (x1)  
Spur gear, 56T, 32P  
Stirnrad, 56T, 32P  
Engrenage cylindrique, 56T, 32P  
Corona, 56T, 32P

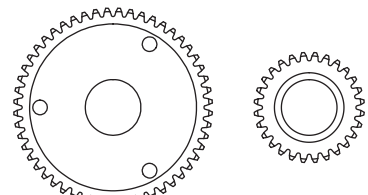



**AX31585** (x1)  
48P Gear set, 28T, 52T  
48P Getriebebesatz, 28T, 52T  
Ensemble d'engrenage 48P, 28T, 52T  
Set ingranaggi 48P, 28T, 52T

AXA1179 (x8) 

AXA1163 (x4) 

AX30162 (x1) 

AX30163 (x4) 

AX31283 (x4) 

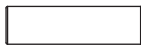
AX30190 (x1) 

AXA1070 (x1) 

AXA1392 (x8) 

AXA1045 (x5) 

AXA1218 (x4) 

AXA1221 (x8) 

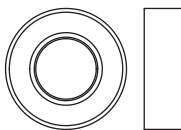
AXA1225 (x2) 

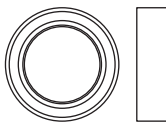
AXA1230 (x2) 

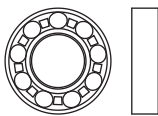
AX31406 (x4) 

AX31407 (x2) 

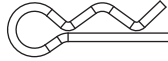
AXA1059 (x2) 

AXA0286 (x6) 

AXA180 (x4) 

AXA291 (x1) 

AXA0109 (x6) 

AX31403 (x4) 

AXA063 (x4) 

AXA065 (x4) 

AXA0113 (x1) 

AXA114 (x12) 

AXA115 (x8) 

AXA116 (x9) 

AXA117 (x12) 

AXA119 (x1) 

AXA120 (x2) 

AXA013 (x11) 

AXA0023 (x2) 

AX3139 (x8) 

AXA053 (x4) 

AXA054 (x2) 

AXA144 (x4) 

AXA146 (x8) 

AXA148 (x4) 

AXA0422 (x1) 

AXA436 (x6) 

AXA437 (x1) 

AXA438 (x2) 

AXA439 (x4) 

AXA440 (x2) 

AXA441 (x4) 



**EXPLODED VIEWS // EXPLOSIONSZEICHNUNGEN // VUES ÉCLATÉES // VISTE ESPLOSE**

**FRONT AXLE  
VORDERACHSE  
ESSIEU AVANT  
ASSALE ANTERIORE**

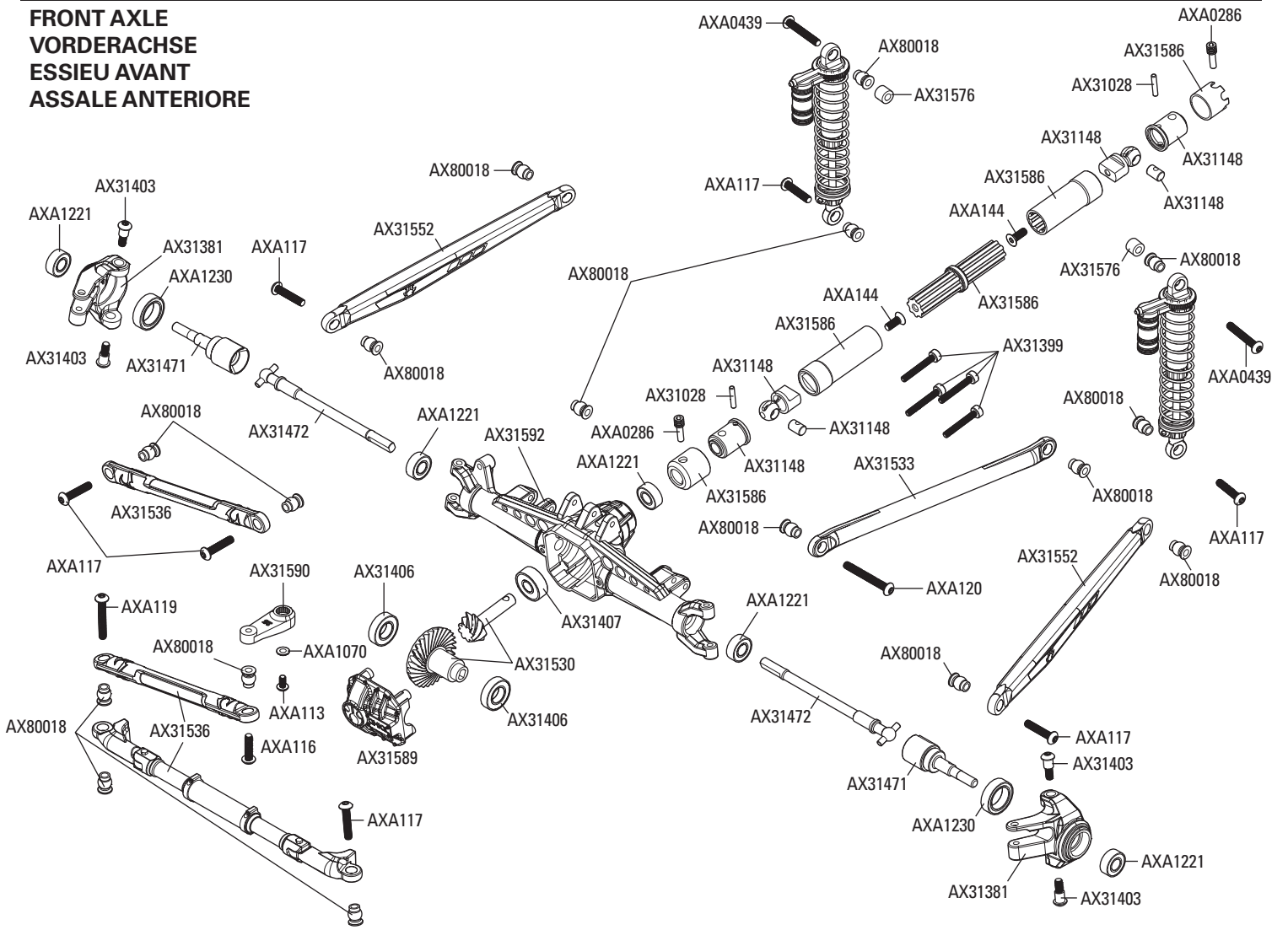

**REAR AXLE  
HINTERACHSE  
ESSIEU ARRIÈRE  
ASSALE POSTERIORE**

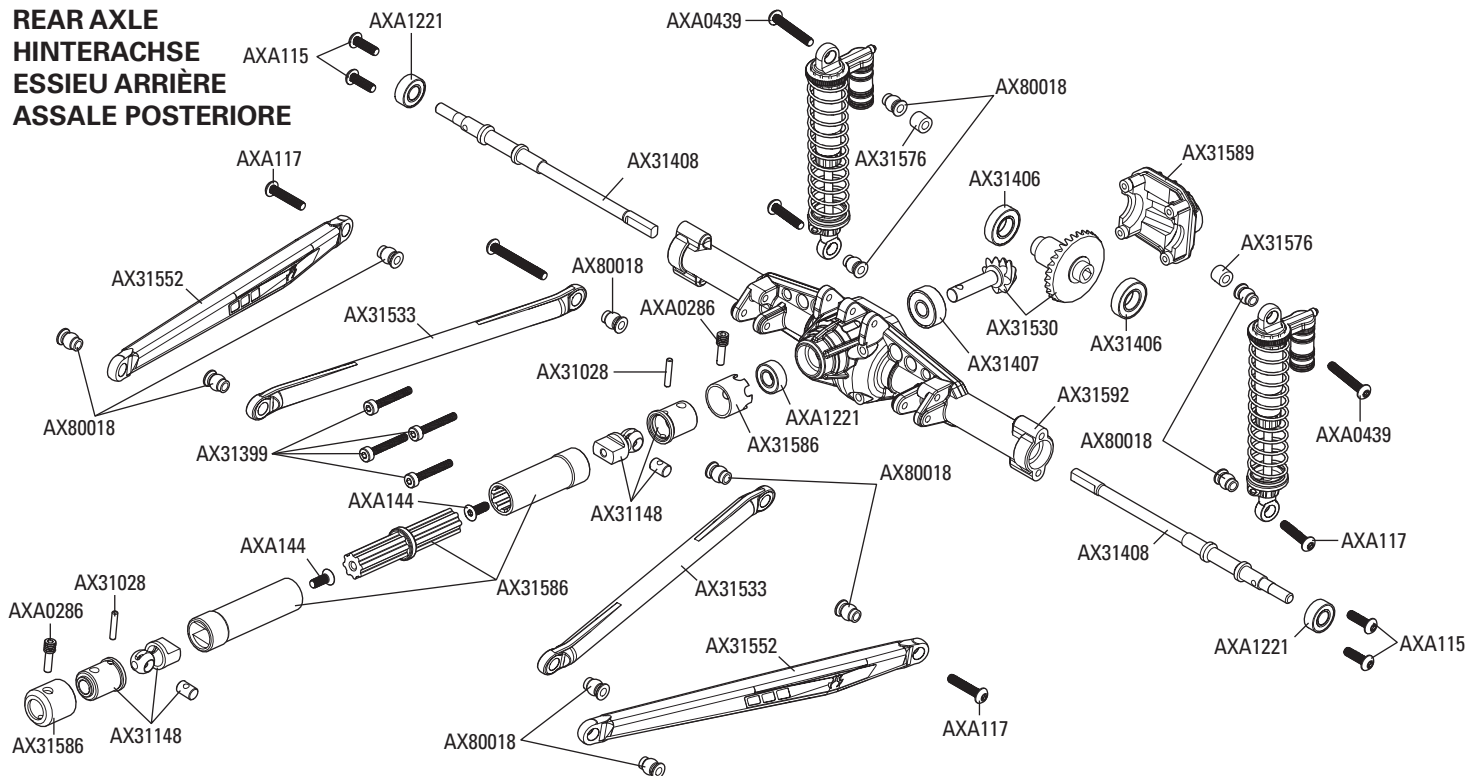

**TRANSMISSION  
GETRIEBE  
TRANSMISSION  
TRASMISSIONE**

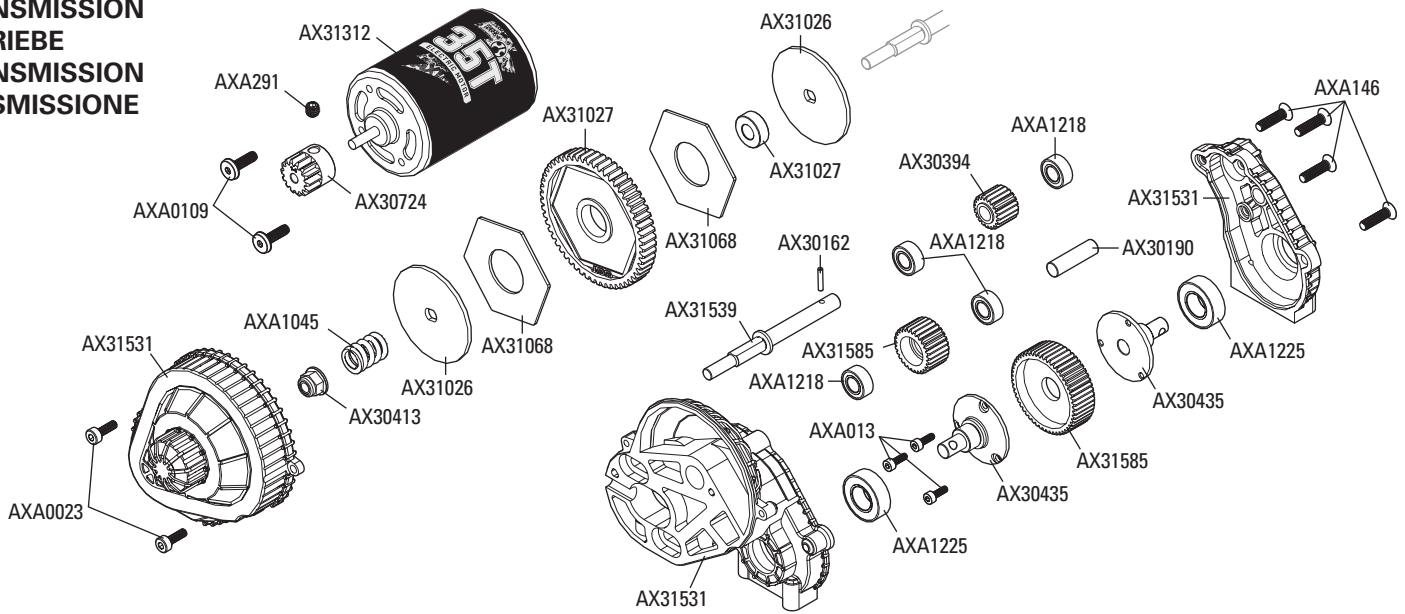

**CHASSIS  
KAROSSERIE  
CHÂSSIS  
TELAIO**

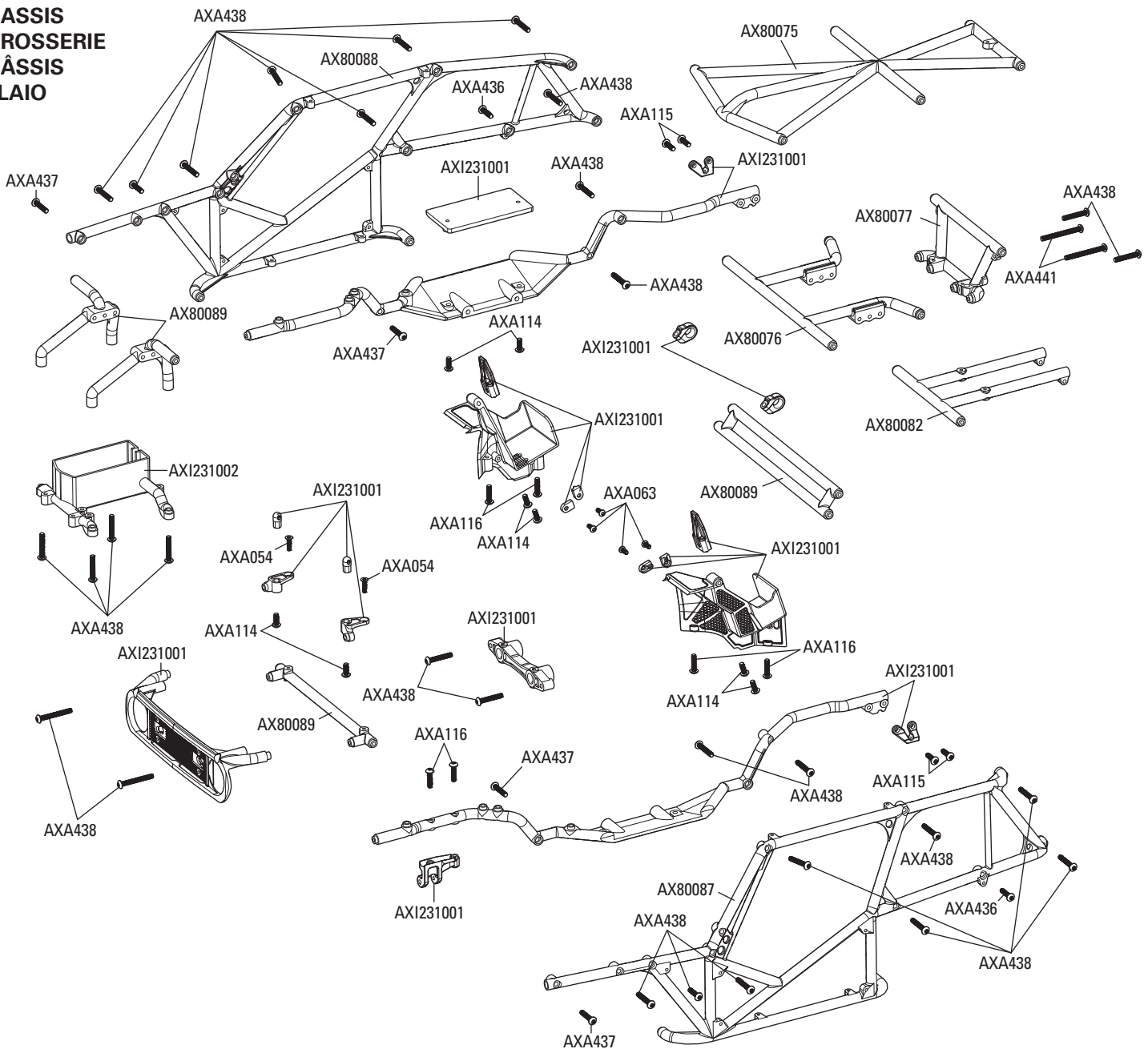

**CHASSIS  
KAROSSERIE  
CHÂSSIS  
TELAIO**

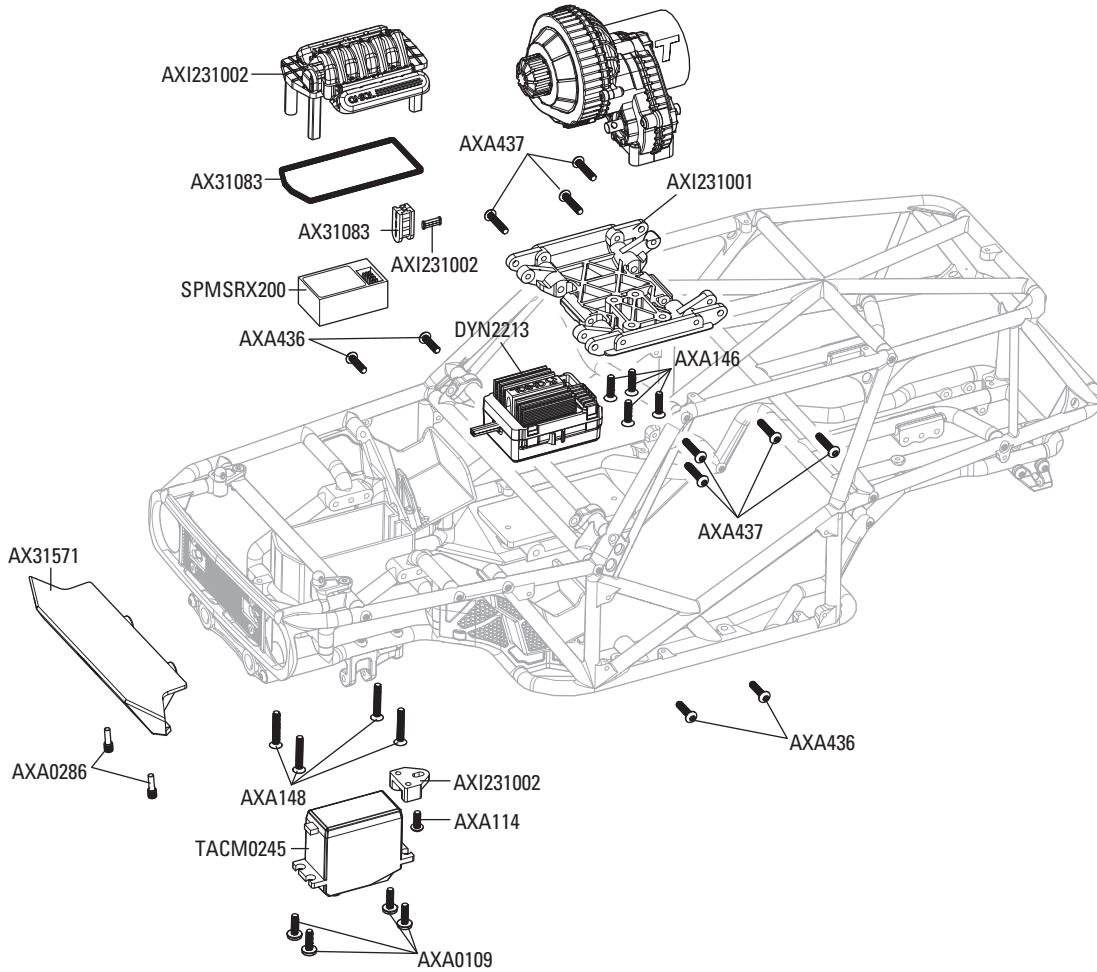

**BODY ASSEMBLY  
KAROSSERIEMONTAGE  
ENSEMBLE DE CARROSSERIE  
GRUPPO CARROZZERIA**

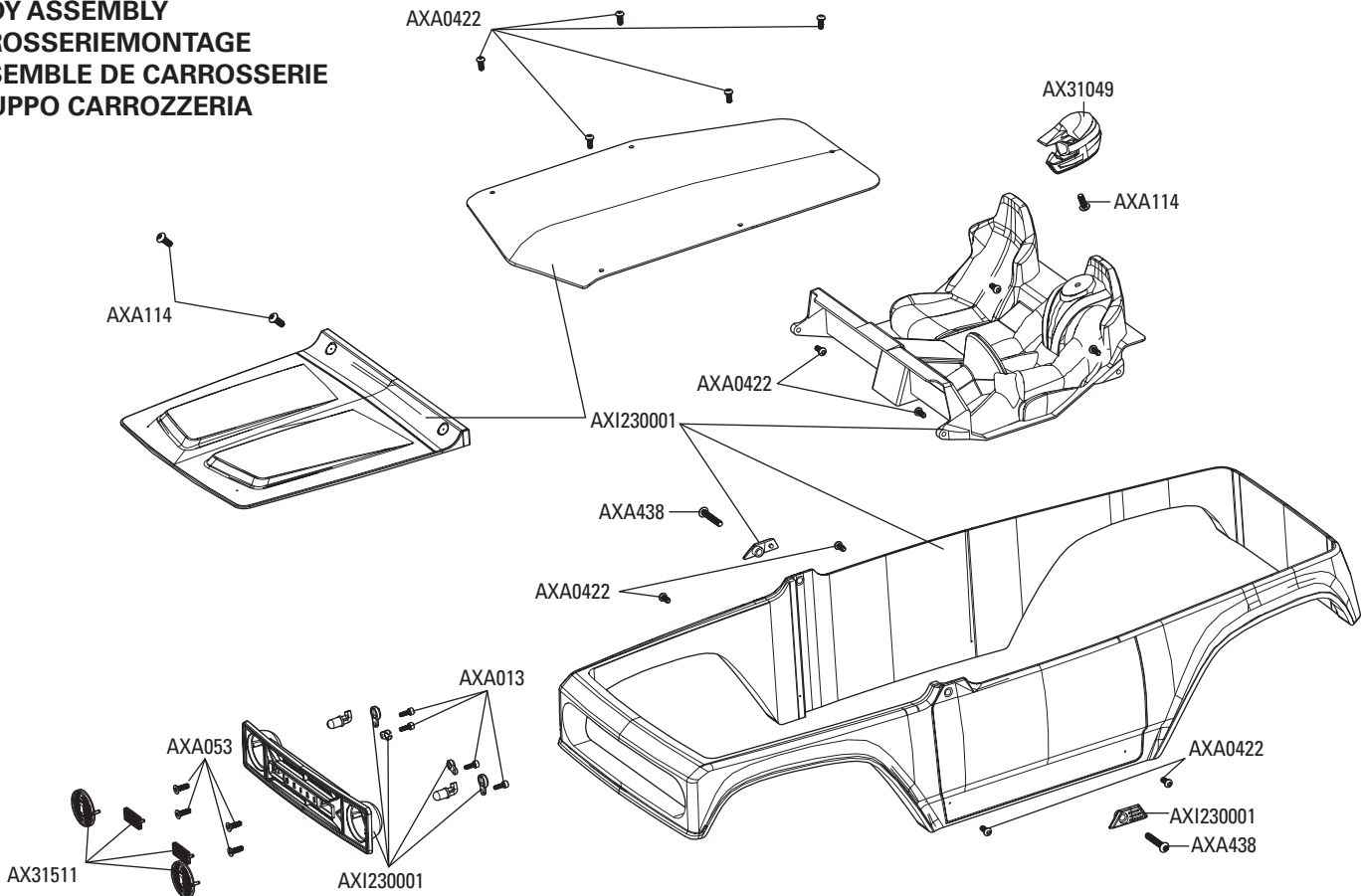

**WHEELS AND TIRES  
REIFEN UND RÄDER  
ROUES ET PNEUS  
RUOTE E PNEUMATICI**

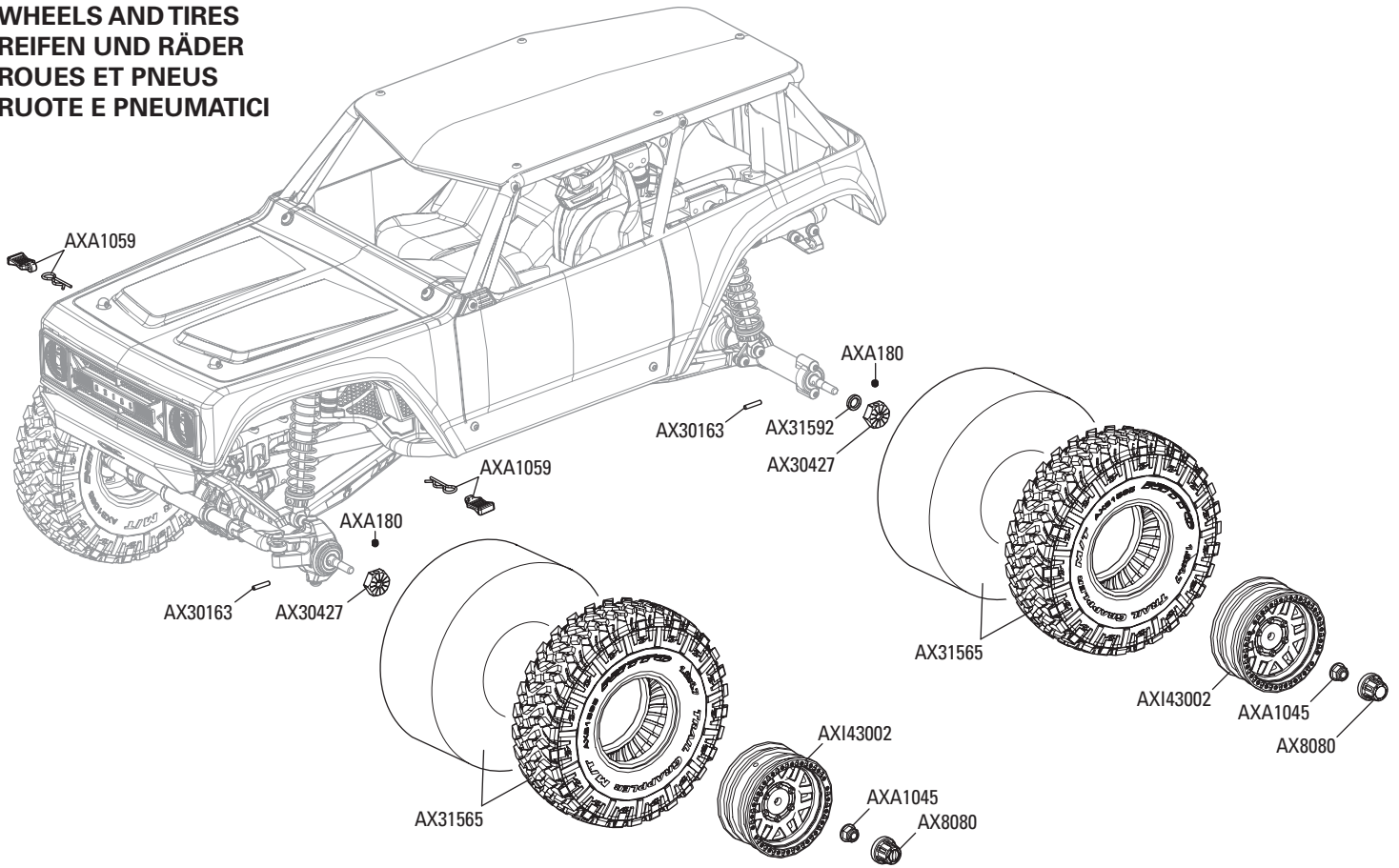

**SHOCK ABSORBERS  
STOSSDÄMPFER  
AMORTISSEURS  
AMMORTIZZATORI**

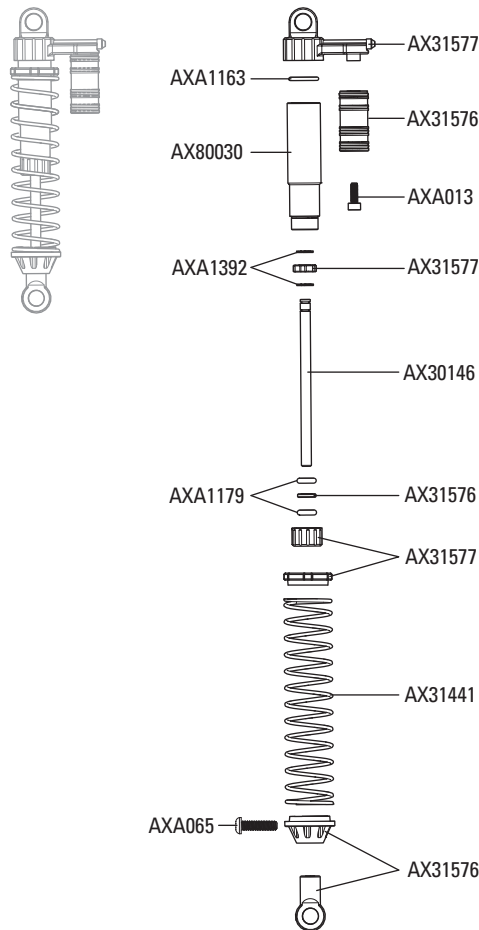



# PARTS LISTS // TEILELISTEN // LISTE DES PIÈCES // ELENCO COMPONENTI

Part #	Description	Beschreibung	Description	Descrizione
AX30146	Shock Shaft 3x50 (2pcs)	Kolbenstange, 3x50 (2 Stck.)	Bras d'amortisseur 3x50 (2 pièces)	Albero ammortizzatore 3x50 (2 pz)
AX30162	Pin 1.5x8mm (6pcs.)	Stift 1,5 x 8 mm (6 Stck.)	Goupille 1,5x8 mm (6 pièces)	Perno 1,5 x 8 mm (6 pz)
AX30163	Pin 2.0x10mm (6pcs.)	Stift 2,0 x 10 mm (6 Stck.)	Goupille 2,0x10 mm (6 pièces)	Perno 2,0 x 10 mm (6 pz)
AX30190	Shaft 5x18 (2pcs.)	Stange 5 x 18 (2 Stck.)	Arbre 5x18 (2 pièces)	Albero 5x18 (2 pz)
AX30394	20T Drive Gear	20T Antriebszahnrad	Engrenage d'entraînement 20T	Ingranaggio trasmissione 20T
AX30413	Slipper spring 8.5x12 165 lbs/in - Black (2pcs)	Gleitfeder 8,5 x 12 75 kg – schwarz (2 Stck.)	Ressort de sabot 8,5x12, 18,6 Nm (165 lb/po) - Noir (2 pièces)	Molla pattino 8,5x12 190 kg/cm (165 libbre/pollice) - nero (2 pz)
AX30427	Axial Narrow 12mm Aluminum Hub - Black (4pcs)	Schmale Aluminium-Achsnabe, 12 mm – schwarz (4 Stck.)	Moyeu axial étroit en aluminium 12 mm - Noir (4 pièces)	Mozzo assale in alluminio stretto, 12 mm - nero (4 pz)
AX30435	Steel Outdrive Shaft Set (2pcs)	Stahl-Flexwellenset (2 Stck.)	Ensemble d'arbre de transmission extérieur en acier (2 pièces)	Set albero outdrive acciaio (2 pz)
AX30724	Pinion Gear 32P 13T (3mm shaft)	Zahnradgetriebe32P 13T (3mm Welle)	Engrenage à pignons 32P 13T (arbre de 3 mm)	Pignone 32P 13T (albero 3 mm)
AX30810	EXO™ Universal Joint Rebuild Set (Front or Rear) (2pcs)	Nachbausatz EXO-Kardangeln (vorne oder hinten) (2 Stck.)	Ensemble de reconstruction de joint universel EXO (avant ou arrière) (2 pièces)	Set ricostruzione giunto cardanico EXO (anteriore o posteriore) (2 pz)
AX31026	Slipper Plate Washer 33x5x1.5mm (2pcs)	Gleitplattenunterlegscheibe 33 x 5 x 1,5mm (2 Stck.)	Rondelle de plaque de sabot 33x5x1,5 mm (2 pièces)	Rondella piastra pattino 33 x 5 x 1,5 mm (2 pz)
AX31027	Spur Gear 32P 56T	Stirnrad 32P 56T	Engrenage cylindrique 32P 56T	Corona 32P 56T
AX31028	Pin 2.0x11mm (6pcs)	Stift 2,0 x 11 mm (6 Stck.)	Goupille 2,0x11 mm (6 pièces)	Perno 2,0 x 11 mm (6 pz)
AX31049	Helmet Set (Black)	Helm-Set (schwarz)	Ensemble de casque (noir)	Set elmetti (nero)
AX31068	Slipper Pad 32.8x15.2x1mm (2pcs)	Gleitkissen 32,8 x 15,2 x 1 mm (2 Stck.)	Sabot de piston 32,8x15,2x1 mm (2 pièces)	Pattino scorrevole 32,8 x 15,2 x 1 mm (2 pz)
AX31083	Radio Box Seals	Funkbox-Dichtungen	Joints du boîtier de radio	Guarnizioni vano radiocomando
AX31148	WB8-HD Driveshaft Coupler Set	WB8-HD-Antriebswellenkupplungssatz	Ensemble de couplage d'arbre de transmission WB8-HD	Set accoppiamento albero trasmissione WB8-HD
AX31148	WB8-HD Driveshaft Coupler Set	WB8-HD-Antriebswellenkupplungssatz	Ensemble de couplage d'arbre de transmission WB8-HD	Set accoppiamento albero trasmissione WB8-HD
AX31280	M2.6x6mm Hex Socket Button Head (Black) (10pcs)	M 2,6 x 6 mm Sechskant-Rundkopf (schwarz) (10 Stck.)	Douille à six pans à tête bombée M2,6x6 mm (Noir) (10 pièces)	Viti testa tonda con esagono incassato M2,6 x 6 mm (nero) (10 pz)
AX31372	M2.6x8mm Hex Socket Flat Head (Black) (10pcs)	M 2,6 x 8 mm Sechskant-Flachkopf (schwarz) (10 Stck.)	Douille à six pans à tête plate M2,6x8 mm (Noir) (10 pièces)	Viti testa piana con esagono incassato M2,6 x 8 mm (nero) (10 pz)
AX31381	AR44 Steering Knuckles	AR44 Lenkrollen	Rotules de direction AR44	Fuso a snodo AR44
AX31399	M2.6x18mm Cap Head (Black) (10pcs)	M 2,6 x 18 mm Inbusschraube (schwarz) (10 Stck.)	Vis d'assemblage creuse M2,6x18 mm (Noir) (10 pièces)	Viti testa cilindrica M2,6 x 18 mm (nero) (10 pz)
AX31403	M3x4x10mm Hex Socket Button Head Shoulder Screw (Black) (6pcs)	M 3 x 4 x 10 mm Sechskant-Pass-Schulterschraube (schwarz) (6 Stck.)	Vis à épaulement à six pans creuse à tête bombée M3x4x10 mm (Noir) (6 pièces)	Viti a perno a testa tonda con esagono incassato M3 x 4 x 10 mm (nero) (6 pz)
AX31406	Bearing 7x14x3.5mm (2pcs)	Lager 7 x 14 x 3,5 mm (2 Stck.)	Roulement 7x14x3,5 mm (2 pièces)	Cuscinetto 7 x 14 x 3,5 mm (2 pz)
AX31407	Bearing 5x14x5mm (2pcs)	Lager 5 x 14 x 5 mm (2 Stck.)	Roulement 5x14x5 mm (2 pièces)	Cuscinetto 5 x 14 x 5 mm (2 pz)
AX31408	AR44 Straight Axle Shaft 5x106mm (2pcs)	AR44 Gerade Achswelle 5 x 106 mm (2 Stck.)	Arbre d'essieu droit AR44 5x106 mm (2 pièces)	Semiassale lineare AR44 5 x 106 mm (2 pz)
AX31441	Spring 12.5x60mm 1.13 lbs/in - (White) (2pcs)	Feder 12,5 x 60 mm 0,5 kg – (weiß) (2 Stck.)	Ressort 12,5x60 mm, 0,12 Nm (1,13 lb-po) - (Blanc) (2 pièces)	Molla 12,5 x 60 mm 1,3 kg/cm (1,13 libbre/pollice) - (bianco) (2 pz)
AX31471	Axle 12x36mm (2pcs)	Achse 12 x 36 mm (2 Stck.)	Essieu 12x36 mm (2 pièces)	Assale 12 x 36 mm (2 pz)
AX31472	Solid Axle Dogbone 6x73.5mm (2pcs)	Solid Axle Dogbone 6 x 73,5 mm (2 Stck.)	Dogbone d'essieu solide 6x73,5mm (2 pièces)	Dogbone assale solido 6 x 73,5 mm (2 pz)
AX31530	AR44 Locker Bevel Gear Set 30T/8T	AR44 Kegellradgetriebe 30T/8T	Ensemble d'engrenage conique de blocage AR44, 30T/8T	Set coppia conica blocco AR44 30T/8T
AX31531	LCX Transmission Case (Silver)	LCX Getriebeabdeckung (silber)	Boîtier de transmission LCX (Argenté)	Scatola del cambio LCX (argento)
AX31536	SCX10 II Steering Link	SCX10 II-Lenkstange	Tringlerie de direction SCX10 II	Collegamento sterzo SCX10 II
AX31538	M2.6x10mm Hex Socket Button Head (Black) (10pcs)	M 2,6 x 10 mm Sechskant-Rundkopf (schwarz) (10 Stck.)	Douille à six pans à tête bombée M2,6x10 mm (Noir) (10 pièces)	Viti testa tonda con esagono incassato M2,6 x 10 mm (nero) (10 pz)
AX31539	Slipper Drive Gear Shaft 5x56.5mm	Gleittriebswelle 5 x 56,5 mm	Arbre d'engrenage d'entraînement du sabot 5x56,5 mm	Albero trasmissione pattino 5 x 56,5 mm
AX31551	Chevrolet K5/C10 Lens Set (Clear)	Chevrolet K5/C10 Linsenset (transparent)	Ensemble de lentille Chevrolet K5/C10 (Transparent)	Set lenti Chevrolet K5/C10 (trasparente)
AX31552	SCX10 II™ Lower Links Set	SCX10 II™ unteres Verbindungsgliedset	Ensemble de timonerie inférieure SCX10 II™	Set leveraggi, inferiore SCX10 II™
AX31553	SCX10 II™ Upper Links Set	SCX10 II™ oberes Verbindungsgliedset	Ensemble de timonerie supérieure SCX10 II	Set leveraggi, superiore SCX10 II™
AX31565	1.9 Nitto Trail Grappler M/T - R35 Compound (2pcs)	1.9 Nitto Trail Grappler M/T – R35 Compound Reifen (2 Stck.)	1.9 Nitto Trail Grappler M/T - R35 Compound (2 pièces)	1.9 Nitto Trail Grappler M/T - composto R35 (2 pz)
AX31571	CRC JK Front Bumper	CRC JK Frontstoßstange	Pare-chocs avant CRC JK	Paraurti anteriore CRC JK
AX31576	Shock Parts	Stoßdämpferteile	Pièces d'amortisseur	Ricambi ammortizzatore
AX31577	Shock Caps	Stoßdämpferkappen	Capuchons d'amortisseurs	Tappi ammortizzatore
AX31586	WB8-HD Standard Driveshaft	WB8-HD Standard-Antriebswelle	Arbre de transmission standard WB8-HD	Albero di trasmissione standard WB8-HD
AX31589	AR44 Differential Covers (Red)	AR44 Differenzialgehäuse (rot)	Couvercles de différentiel AR44 (rouge)	Carter differenziale AR44 (rosso)
AX31592	AR44 Solid Axle Housing (Front and Rear)	AR44 solides Achsgehäuse (vorne und hinten)	Carter d'essieu solide AR44 (avant et arrière)	Alloggiamento solido assale AR44 (anteriore e posteriore)

Part #	Description	Beschreibung	Description	Descrizione
AX80010	Gear Set	Getriebebesatz	Ensemble de train	Set ingranaggi
AX80018	Hardware Parts Tree	Hardware-Teilebaum	Arbre des pièces de quincaillerie	Set bulloneria
AX80030	61-90 Shock Body Set	61-90 Stoßdämpferset	Ensemble de corps d'amortisseur 61-90	Set scocca ammortizzatore 61-90
AX80075	Wraith Tube Frame Top	Wraith Rohrgestell oben	Haut du châssis tubulaire Wraith	Telaio tubolare Wraith, parte superiore
AX80076	Wraith Tube Frame Shock Mount (Rear)	Wraith Rohrgestell-Stoßdämpferhalterung (hinten)	Support d'amortisseurs du châssis tubulaire Wraith (arrière)	Supporto ammortizzatore telaio tubolare Wraith (posteriore)
AX80077	Wraith Tube Frame Bumper	Wraith Rohrgestell-Stoßdämpfer	Pare-chocs du châssis tubulaire Wraith	Paraurti telaio tubolare Wraith
AX80082	Wraith Tube Frame Brace Set	Wraith Rohrgestellhalterungset	Ensemble de support du châssis tubulaire Wraith	Set bretella telaio tubolare Wraith
AX80087	Wraith Tube Frame Side (Left)	Wraith seitliches Rohrgestell (links)	Côté du châssis tubulaire Wraith (gauche)	Telaio tubolare laterale Wraith (sinistro)
AX80088	Wraith Tube Frame Side (Right)	Wraith seitliches Rohrgestell (rechts)	Côté du châssis tubulaire Wraith (droite)	Telaio tubolare laterale Wraith (destra)
AX80089	Wraith Tube Frame Shock Mount (Front)	Wraith Rohrgestell-Stoßdämpferhalterung (vorne)	Support d'amortisseurs du châssis tubulaire Wraith (avant)	Supporto ammortizzatore telaio tubolare Wraith (anteriore)
AX8080	Hub Cover Set - Satin Chrome (4pcs)	Nabenabdeckungsset – matt verchromt (4 Stck.)	Ensemble de caches de moyeu - Chrome satiné (4 pièces)	Set coprimozzo - cromo satinato (4 pz)
AXA0023	M2.6x8mm Cap Head (Black) (10pcs)	M 2,6 x 8 mm Inbusschraube (schwarz) (10 Stck.)	Vis d'assemblage creuse M2,6x8 mm (Noir) (10 pièces)	Viti testa cilindrica M2,6 x 8 mm (nero) (10 pz)
AXA0055	M2.6x12mm Flat Head (Black) (10pcs)	M 2,6 x 12 mm Inbusschraube (schwarz) (10 Stck.)	Vis à tête plate M2,6x12 mm (Noir) (10 pièces)	Viti testa piana M2,6 x 12 mm (nero) (10 pz)
AXA0109	M3x10mm Oversized Flat Hex Socket (Black) (10pcs)	M 3 x 10 mm übergroßer Sechskant-Flachkopf (schwarz) (10 Stck.)	Douille à six pans à tête plate surdimensionnée M3x10 mm (Noir) (10 pièces)	Viti oversize a testa piana con incasso esagonale M3 x 10 mm (nero) (10 pz)
AXA0113	M3x6mm Hex Socket Button Head (Black) (10pcs)	M 3 x 6 mm Sechskant-Rundkopf (schwarz) (10 Stck.)	Douille à six pans à tête bombée M3x6 mm (Noir) (10 pièces)	Viti testa tonda con esagono incassato M3 x 6 mm (nero) (10 pz)
AXA013	M2x6 mm Cap Head (Black) (10pcs)	M 2 x 6 mm Inbusschraube (schwarz) (10 Stck.)	Vis d'assemblage creuse M2x6 mm (Noir) (10 pièces)	Viti testa cilindrica M2 x 6 mm (nero) (10 pz)
AXA0286	Screw Shaft M4x2.5x12mm (6pcs)	Gewindenschaft M 4 x 2,5 x 12 mm (6 Stck.)	Tige de vis M4x2,5x12 mm (6 pièces)	Albero filettato M4 x 2,5 x 12 mm (6 pz)
AXA0414	M2.6x10mm Hex Socket Tapping Flat Head (Black) (10pcs)	M 2,6 x 10 mm Sechskant-Flachkopf-Blechschrabe (schwarz) (10 Stck.)	Douille à six pans à tête plate autotaraudeuse M2,6x10 mm (Noir) (10 pièces)	Viti autofilettanti a testa piana con esagono incassato M2,6 x 10 mm (nero) (10 pz)
AXA0422	M2.6x6mm Hex Socket Tapping Button Head (Black) (10pcs)	M 2,6 x 6 mm Sechskant-Rundkopf-Blechschrabe (schwarz) (10 Stck.)	Douille à six pans à tête bombée autotaraudeuse M2,6x6 mm (Noir) (10 pièces)	Viti autofilettanti a testa tonda con esagono incassato M2,6 x 6 mm (nero) (10 pz)
AXA0437	M3x15mm Hex Socket Tapping Button Head (Black) (10pcs)	M 3 x 15 mm Sechskant-Rundkopf-Blechschrabe (schwarz) (10 Stck.)	Douille à six pans à tête bombée autotaraudeuse M3x15 mm (Noir) (10 pièces)	Viti autofilettanti a testa tonda con esagono incassato M3 x 15 mm (nero) (10 pz)
AXA0439	M3x20mm Hex Socket Tapping Button Head (Black) (10pcs)	M 3 x 20 mm Sechskant-Rundkopf-Blechschrabe (schwarz) (10 Stck.)	Douille à six pans à tête bombée autotaraudeuse M3x20 mm (Noir) (10 pièces)	Viti autofilettanti a testa tonda con esagono incassato M3 x 20 mm (nero) (10 pz)
AXA1045	M4 Nylon Lock Nut (Black) (10pcs)	M4 Nylon-Feststellmutter (schwarz) (10 Stck.)	Contre-écrou en nylon M4 (Noir) (10 pièces)	Controdado nylon M4 (nero) (10 pz)
AXA1059	6mm Body clip (Black) (10pcs)	6 mm Gehäuseklemmen (schwarz) (10 Stck.)	Clip de carrosserie 6 mm (Noir) (10 pièces)	Clip carrozzeria 6 mm (nero) (10 pz)
AXA1070	Washer 3x6x0.5 (10pcs)	Unterlegscheibe 3 x 6 x 0,5 (10 Stck.)	Rondelle 3x6x0,5 (10 pièces)	Rondella 3 x 6 x 0,5 (10 pz)
AXA114	M3x8mm Hex Socket Button Head (Black) (10pcs)	M 3 x 8 mm Sechskant-Rundkopf (schwarz) (10 Stck.)	Douille à six pans à tête bombée M3x8 mm (Noir) (10 pièces)	Viti testa tonda con esagono incassato M3 x 8 mm (nero) (10 pz)
AXA115	M3x10mm Hex Socket Button Head (Black) (10pcs)	M 3 x 10 mm Sechskant-Rundkopf (schwarz) (10 Stck.)	Douille à six pans à tête bombée M3x10 mm (Noir) (10 pièces)	Viti testa tonda con esagono incassato M3 x 10 mm (nero) (10 pz)
AXA116	M3x12mm Hex Socket Button Head - Black (10pcs)	M 3 x 12 mm Sechskant-Rundkopf (schwarz) (10 Stck.)	Douille à six pans à tête bombée M3x12 mm - Noir (10 pièces)	Viti testa tonda con esagono incassato M3 x 12 mm (nero) (10 pz)
AXA1163	O-Ring 7x1mm (10pcs)	O-Ring 7 x 1 mm (10 Stck.)	Joint torique 7x1 mm (10 pièces)	O-Ring 7 x 1 mm (10 pz)
AXA117	M3x15mm Hex Socket Button Head (Black) (10pcs)	M 3 x 15 mm Sechskant-Rundkopf (schwarz) (10 Stck.)	Douille à six pans à tête bombée M3x15 mm (Noir) (10 pièces)	Viti testa tonda con esagono incassato M3 x 15 mm (nero) (10 pz)
AXA1179	O-Ring 2.5x1.5mm (10pcs)	O-Ring 2,5 x 1,5 mm (10 Stck.)	Joint torique 2,5x1,5 mm (10 pièces)	O-Ring 2,5 x 1,5 mm (10 pz)
AXA119	M3x20mm Hex Socket Button Head (Black) (10pcs)	M 3 x 20 mm Sechskant-Rundkopf (schwarz) (10 Stck.)	Douille à six pans à tête bombée M3x20 mm (Noir) (10 pièces)	Viti testa tonda con esagono incassato M3 x 20 mm (nero) (10 pz)
AXA120	M3x25mm Hex Socket Button Head (Black) (10pcs)	M 3 x 25 mm Sechskant-Rundkopf (schwarz) (10 Stck.)	Douille à six pans à tête bombée M3x25 mm (Noir) (10 pièces)	Viti testa tonda con esagono incassato M3 x 25 mm (nero) (10 pz)
AXA1218	Bearing 5x10x4mm (2pcs)	Lager 5 x 10 x 4 mm (2 Stck.)	Roulement 5x10x4 mm (2 pièces)	Cuscinetto 5 x 10 x 4 mm (2 pz)
AXA1221	Bearing 5x11x4mm (2pcs)	Lager 5 x 11 x 4 mm (2 Stck.)	Roulement 5x11x4 mm (2 pièces)	Cuscinetto 5 x 11 x 4 mm (2 pz)
AXA1225	Bearing 8x16x5mm (2pcs)	Lager 8 x 16 x 5 mm (2 Stck.)	Roulement 8x16x5 mm (2 pièces)	Cuscinetto 8 x 16 x 5 mm (2 pz)
AXA1230	Bearing 10x15x4mm	Lager 10 x 15 x 4 mm	Roulement 10x15x4 mm	Cuscinetto 10 x 15 x 4 mm
AXA1392	E2 e-clip (10pcs)	E2 E-Clip (10 Stck.)	E-Clip E2 (10 pièces)	E-clip E2 (10 pz)
AXA144	M3x8mm Hex Socket Flat Head (Black) (10pcs)	M 3 x 8 mm Sechskant-Flachkopf (schwarz) (10 Stck.)	Douille à six pans à tête plate M3x8 mm (Noir) (10 pièces)	Viti testa piana con esagono incassato M3 x 8 mm (nero) (10 pz)
AXA146	M3x12mm Hex Socket Flat Head - Black (10pcs)	M 3 x 12 mm Sechskant-Flachkopf (schwarz) (10 Stck.)	Douille à six pans à tête plate M3x12 mm - Noir (10 pièces)	Viti testa piana con esagono incassato M3 x 12 mm (nero) (10 pz)
AXA148	M3x18mm Hex Socket Flat Head (Black) (10pcs)	M 3 x 18 mm Sechskant-Flachkopf (schwarz) (10 Stck.)	Douille à six pans à tête plate M3x18 mm (Noir) (10 pièces)	Viti testa piana con esagono incassato M3 x 18 mm (nero) (10 pz)
AXA180	M3x3mm Set Screw (Black) (10pcs)	M 3 x 3 mm Schraubenset (schwarz) (10 Stck.)	Vis de fixation M3x3 mm (Noir) (10 pièces)	Vite di arresto M3 x 3 mm (nero) (10 pz)
AXA291	M4x4mm Set Screw (Black) (6pcs.)	M 4 x 4 mm Schraubenset (schwarz) (6 Stck.)	Vis de fixation M4x4 mm (Noir) (6 pièces)	Vite di arresto M4 x 4 mm (nero) (6 pz)

Part #	Description	Beschreibung	Description	Descrizione
AXA436	M3x12mm Hex Socket Tapping Button Head (Black) (10pcs)	M 3 x 12 mm Sechskant-Rundkopf-Blechschrabe (schwarz) (10 Stck.)	Douille à six pans à tête bombée autotaraudeuse M3x12 mm (Noir) (10 pièces)	Viti autofilettanti a testa tonda con esagono incassato M3 x 12 mm (nero) (10 pz)
AXA438	M3x18mm Hex Socket Tapping Button Head (Black) (10pcs)	M 3 x 18 mm Sechskant-Rundkopf-Blechschrabe (schwarz) (10 Stck.)	Douille à six pans à tête bombée autotaraudeuse M3x18 mm (Noir) (10 pièces)	Viti autofilettanti a testa tonda con esagono incassato M3 x 18 mm (nero) (10 pz)
AXA440	M3x25mm Hex Socket Tapping Button Head (Black) (10pcs)	M 3 x 25 mm Sechskant-Rundkopf-Blechschrabe (schwarz) (10 Stck.)	Douille à six pans à tête bombée autotaraudeuse M3x25 mm (Noir) (10 pièces)	Viti autofilettanti a testa tonda con esagono incassato M3 x 25 mm (nero) (10 pz)
AXA441	M3x30mm Hex Socket Tapping Button Head (Black) (10pcs)	M 3 x 30 mm Sechskant-Rundkopf-Blechschrabe (schwarz) (10 Stck.)	Douille à six pans à tête bombée autotaraudeuse M3x30 mm (Noir) (10 pièces)	Viti autofilettanti a testa tonda con esagono incassato M3 x 30 mm (nero) (10 pz)
AXI43001	1.9 KMC Machete Wheel - 26mm wide (satin Chrome)	1.9 KMC Macheten-Rad – 26 mm( matt verchromt)	Roue Machete 1.9 KMC - 26 mm de large (chrome satiné)	Ruota 1.9 KMC Machete - larg. 26 mm (cromo satinato)
AXI230001	Wraith 1.9 Body & Interior Set: Clear	Wraith 1.9 Gehäuse- und Interieurset: Transparent	Ensemble de carrosserie et d'intérieur Wraith 1.9 : Transparent	Set carrozzeria e interni Wraith 1.9: trasparente
AXI231001	Wraith 1.9 Lower Rail/Skid Plate/ Battery Tray	Wraith 1.9 untere Schiene/Gleitbrett/ Akkuhalterung	Rail inférieur/Plaque de protection/ Support de batterie Wraith 1.9	Guide inferiori/piastra protezione/ vassoio portabatteria Wraith 1.9
AXI231002	Wraith 1.9 Receiver Box Parts Tree	Wraith 1.9 Empfängerbox Teilebaum	Arbre des pièces du boîtier de récepteur Wraith 1.9	Set ricambi vano ricevitore Wraith 1.9
AXI43001	1.9 KMC Machete Wheel - Satin Silver (2pcs)	1.9 KMC Macheten-Rad – Satinsilber (2 Stck.)	Roue Machete 1.9 KMC - Argent satiné (2 pièces)	Ruota 1.9 KMC Machete - argento satinato (2 pz)

## ELECTRONICS // ELETTRONIK // COMPOSANTS ÉLECTRONIQUES // ELETTRONICA

Part #	Description	Beschreibung	Description	Descrizione
AX31312	35T Electric Motor	35T Elektromotor	Moteur électrique 35T	Motore elettrico 35T
SPMSTX200	STX2 2CH Radio	STX2 2CH Funk	Radio 2 canaux STX2	Radiocomando STX2 2 canali
SPMSRX200	SRX200 2CH Receiver	SRX200 2CH Empfänger	Récepteur 2 canaux SRX200	Ricevitore SRX200 2 canali
TACM0245	TSX45 High-Torque Metal Gear Dual Ball Bearing Servo	TSX45 Metallgetriebe servo mit hohem Drehmoment und doppeltem Kugellager	Servo à deux roulements à billes à engrenages métalliques à couple élevé TSX45	Servo TSX45 a coppia elevata, ingranaggio metallico e doppio cuscinetto a sfera
DYNS2213	AE-5L ESC w/LED Ports and Lights (2 White, 4 White, 2 Red)	AE-5L Geschwindigkeitsregler mit LED-Anschlüssen und -Leuchten (2 x weiß, 4 x weiß, 2 x rot)	Variateur ESC AE-5L avec ports et témoins DEL (2 blancs, 4 blancs, 2 rouges)	ESC AE-5L con porte e luci LED (2 bianche, 4 bianche, 2 rosse)
AX31481	AE-5L LED Light Set (2 White, 4 White, 2 Red)	AE-5L LED-Leuchten (2 x weiß, 4 x weiß, 2 x rot)	Ensemble de témoins DEL AE-5L (2 blancs, 4 blancs, 2 rouges)	Set luci LED AE-5L (2 bianche, 4 bianche, 2 rosse)

OFFICIALLY LICENSED BY:

AXI90074-1001

**KMC**  
W H E E L S

**NITTO**

**CRC**

**WRAITH™**



**EXPLORE**

[facebook.com/axialinc](https://facebook.com/axialinc) | [instagram.com/axialracing](https://instagram.com/axialracing) | [twitter.com/axialrc](https://twitter.com/axialrc)  
[youtube.com/axialvideos](https://youtube.com/axialvideos) | [flickr.com/axialrc](https://flickr.com/axialrc)

 **axial®**  
[www.axialracing.com](http://www.axialracing.com)

©2019 Horizon Hobby, LLC.

Axial, the Axial logo, Wraith, DSM, STX2, IC3 and the Horizon Hobby logo are trademarks or registered trademarks of Horizon Hobby, LLC. The Spektrum trademark is used with permission of Bachmann Industries, Inc. Nitto® and Trail Grappler® are registered trademarks of Nitto Tire U.S.A., Inc. All other trademarks, service marks and logos are property of their respective owners. US 9,592,724.

Completed 1/19

AXI90074

59060