

# REEFRACER<sup>2</sup>



**AQUACRAFT**<sup>TM</sup>  
Models by **HOBBICO**<sup>®</sup>

## Warranty

- AquaCraft<sup>TM</sup> will warrant this kit for 90 days after the purchase from defects in materials or workmanship. AquaCraft will either repair or replace, at no charge, the incorrectly made part.
- Make sure you save the receipt or invoice you were given when you bought your model! It is your proof of purchase and we must see it before we can honor the warranty.
- To return your Reef Racer 2<sup>TM</sup> for repairs covered under warranty, you should send your boat to:

Hobby Services  
3002 N. Apollo Drive, Suite 1  
Champaign, Illinois 61822  
Attn: Service Department  
Phone: (217) 398-0007 9:00 am - 5:00 pm Central Time M-F  
E-mail: [hobbyservices@hobbico.com](mailto:hobbyservices@hobbico.com)

## Before Building:

Thank you for purchasing the Reef Racer 2! This manual contains the instructions you need to safely operate and maintain your boat. We want the operation of this boat to be a success so BEFORE preparing the Reef Racer 2 for action please read this manual thoroughly. If for any reason you think that this model is not for you, return it to your local dealer immediately. PLEASE NOTE: Your hobby dealer cannot accept a return on any model after final assembly sequence has begun.

## SAFETY PRECAUTIONS

- Adult supervision is strongly recommended! **Children should be warned** about the dangers of playing in close proximity to water.
- Do not attempt to charge battery packs in the immediate vicinity of swimming pools, lakes, rivers, oceans, inland seas, etc. Above all, **NEVER ATTEMPT TO OPERATE A CHARGER IF YOU, THE CHARGER, OR THE BATTERY PACK ARE WET.**
- **Always** remove the battery pack from the boat before recharging.
- This boat is controlled by radio signals, which are susceptible to possible interference from other R/C transmitters, paging systems, or other electrical noise. **Before turning your radio transmitter and boat "ON"**, make sure no one else in the area is operating a radio on the same frequency (channel).
- Do not touch the propeller anytime the electronics are turned "ON". **Pay close attention** to items such as loose clothing, shirtsleeves, ties, scarves, long hair or any loose objects that may come in contact with the spinning propeller. If your fingers, hands, etc. come in contact with the spinning propeller, you may be severely injured.
- The speed and mass of this boat can inflict property damage and severe personal injury if a collision occurs. **Never run this boat in the presence of swimmers** or where the possibility of collision with people or property exists.
- Electric motors can generate considerable heat. **Do not touch any part of your motor** until it has cooled. Touching the motor immediately after running the boat may result in a serious burn.

**If the buyer is not prepared to accept the liability associated with the use of this product, the buyer is advised to return this kit immediately in new and unused condition to the place of purchase.**

## REPAIR SERVICE

Repair service is available anytime.

After the 90-day warranty, you can still have your Reef Racer 2 repaired for a small charge by the experts at AquaCraft's authorized repair facility, **Hobby Services**, at the address listed on the front page of this manual.

To speed up the repair process, please follow these instructions:

1. Under all circumstances return the **ENTIRE** system; battery pack, charger, boat and radio.

2. Make sure the electronics are turned off and all batteries are removed.
3. Send written instructions which include a list of all items returned, a **THOROUGH** explanation of the problem, the service needed and your phone number during the day. If you expect the repair to be covered under warranty, be sure to include a proof-of-purchase date (your store receipt or purchase invoice).
4. Also be sure to send your full return address.

## SPECIFICATION & DESCRIPTION CHANGES

All pictures, descriptions, and specifications found in this instruction manual are subject to change without notice. AquaCraft maintains no responsibility for inadvertent errors in this manual.

## USEFUL TOOLBOX ITEMS

**It is a good idea to assemble a useful collection of tools to bring along anytime you head out to the pond. Here are some items you may wish to keep handy.**

- #2 Phillips Screwdriver (HCAR1024)
- 1.5mm Hex Driver (HCAR1150)
- 4mm Socket or Wrench
- Paper Towels
- Spray-on Glass Cleaner
- Hook & Loop Material (GPMQ4480)
- Hobby Knife (HCAR0109)
- Electrical Tape

## FINAL ASSEMBLY SEQUENCE

### TRANSMITTER ASSEMBLY

**Important Note:** The **transmitter is not water-resistant** and should never come in contact with water.

1. Remove the transmitter antenna from the transmitter box and screw it into the top of the transmitter. To ensure that the antenna is attached, lightly pull on the base of the antenna. If it slides out, it is not installed properly.

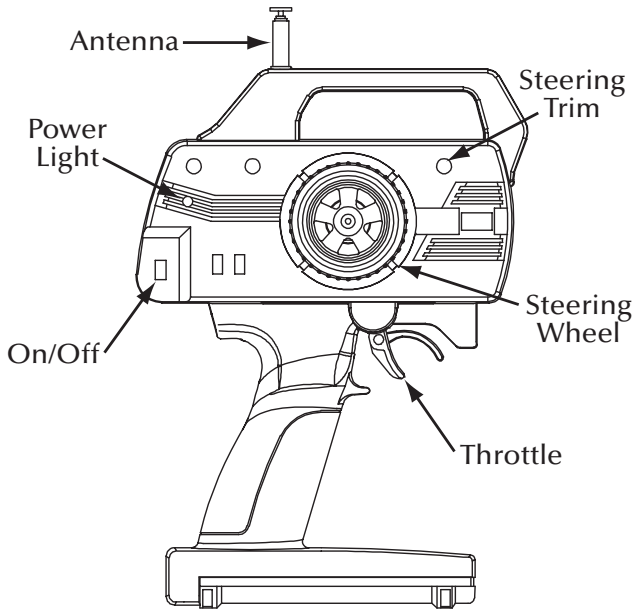

❑ 2. Slide off the battery door on the bottom of the transmitter. Install 8 fresh “AA” batteries into the bottom of the transmitter in the configuration molded into the battery holder. Re-install the battery door onto the bottom of the transmitter.

❑ 3. Turn the transmitter “ON” using the switch on the front. The red LED light next to the on/off switch should light up. If the LED begins flashing erratically, turn the transmitter off and check to make sure that the batteries are installed properly. **If you see a steadily flashing LED, the batteries are low and need to be replaced.**

#### **BATTERY PACK CHARGING & INSTALLATION SEQUENCE**

- **IMPORTANT!** The included charger unit is designed for use in an automobile’s 12-volt power outlet.
- **Do not attempt to charge a battery pack while the automobile is running.**
- **The charger is equipped with a 70” charging lead. It is highly recommended that the charger be placed outside of the vehicle while in use.**
- **NEVER LEAVE A CHARGER AND BATTERY PACK UNATTENDED WHILE CHARGING.**
- **Use only the battery pack and charger intended for use with the Reef Racer 2. In the event that you use a different battery charger, charge this pack at a maximum charge rate of 1.2 amps.**
- **Charge the battery pack only after it has been fully discharged.**



❑ 1. Plug the battery charger into an automobile’s 12-volt power outlet as shown.

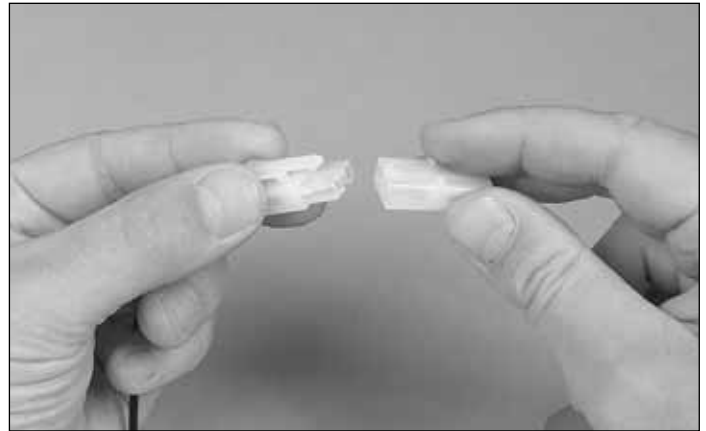

❑ 2. Join the battery and charger connectors as shown. Do not force them together; they are designed to fit together only one way.



❑ 3. Set the charger’s timer to **30 minutes**. The red LED on the charger will illuminate to indicate that charging is in progress. It is a good idea to check the battery pack every five (5) minutes. If at any time the battery pack becomes very hot during the charging process, immediately unplug the charger from the outlet and allow the battery to cool completely before attempting to use.

❑ 4. After charging is completed, unplug the charger unit from the outlet. Disconnect the battery and charger connectors by pushing the small tab down while gently pulling the connectors apart.

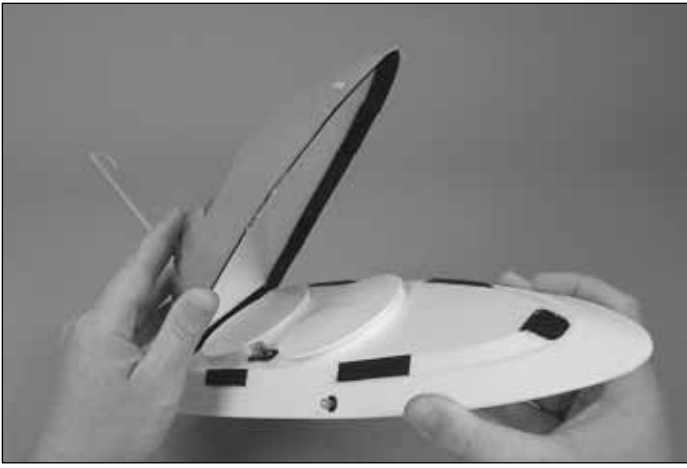

❑ 5. The canopy is held to the deck of the Reef Racer 2 with hook & loop material. Open the battery compartment of the Reef Racer 2 by gently lifting the canopy as shown.

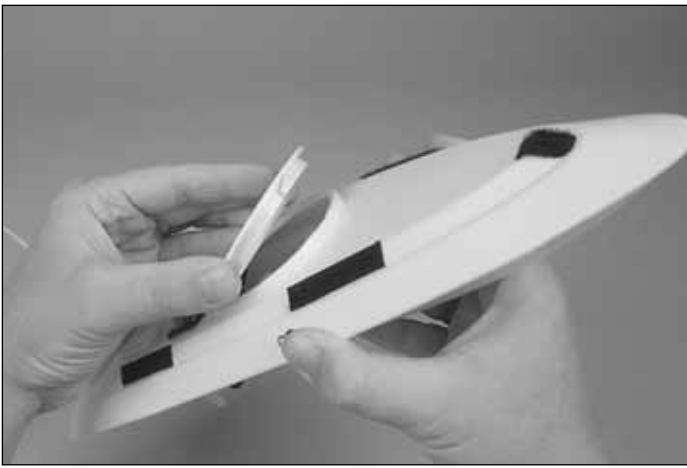

❑ 6. Each hatch lid is held in place by tabs. Twist the forward lid until the tabs line up with the slots and gently lift the lid from the deck as shown.

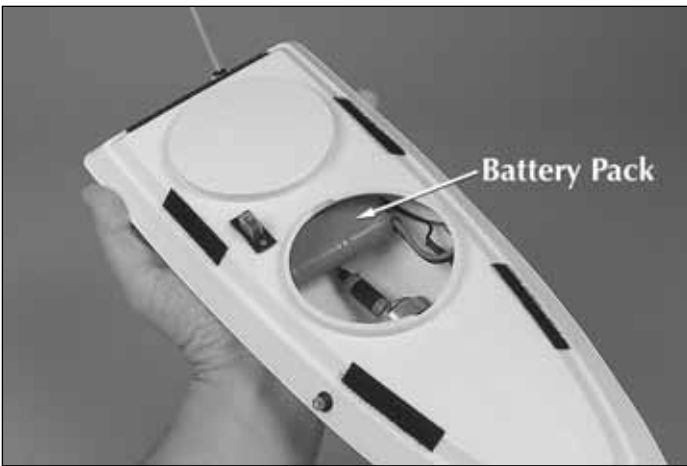

❑ 7. Plug the battery pack into the boat's battery connector. Do not force them together; they are designed to fit together only one way. Place the battery pack in the battery tray with the provided hook & loop material as shown.

❑ 8. Replace the forward hatch lid with the tabs lined up with the slots and give it a twist to lock it in place.

#### CHECK OPERATION:



❑ 1. Turn the power "ON" to the transmitter and then the boat (in that order). Place the canopy on top of the Reef Racer 2 hull and make sure that the hook & loop material attach securely.

❑ 2. Standing behind the boat with both the Reef Racer 2 and transmitter "ON", rotate the wheel to the left. The back of the rudder should move towards the left. Move the wheel to the right. The back of the rudder should move towards the right.

❑ 3. Squeeze the trigger on the transmitter, the propeller should turn in a counter-clockwise motion.

❑ 4. Turn the power "OFF" to your boat and then your transmitter.

#### **PLEASE READ BEFORE RUNNING THE REEF RACER 2**

- **NEVER** attempt to swim after a stalled or capsized boat! Wait patiently for the wind currents to return the boat to shore or use a tennis ball attached to the end of a fishing rod to retrieve it.
- It is dangerous to operate any R/C vehicle at any time that there is insufficient light.

- R/C models produce vibrations which *will* cause screws, nuts, bolts, etc, on your model to become loose over time. **It is important to make sure that all hardware is secure** before operating your model.
- **The edges of the propeller are very sharp and can cut your fingers** if you are not careful. Never attempt to stop the prop with your hand. In the event that weeds become entangled in the propeller, turn the Reef Racer 2's power "OFF" before attempting to remove them.
- **CAUTION:** Your Reef Racer 2 may take on small amounts of water, especially when running in rough water due to high winds or when making tight turns. Keep a roll of paper towels handy and dry out the hull interior after every run.
- Total run time of the Reef Racer 2 is approximately 6-10 minutes (assuming you begin with a fully charged battery pack). When you notice a decrease in power or sluggish steering response, it means the battery pack is nearly drained and it's time to head for shore. As soon as the boat reaches shore, turn off the power to the boat's receiver and transmitter (in that order).
- **CAUTION: The motor and battery may be hot!** Allow them to cool for a few minutes before attempting to remove the battery pack.
- **After you are done running for the day**, store your Reef Racer 2 with both hatch lids removed to allow the interior to dry out completely. If you fail to do this, it may result in corrosion of the electronic components.
- **IMPORTANT:** If your boat takes on a large amount of water causing the radio equipment to get wet, you must do the following **immediately**: Remove the battery pack and radio equipment from the boat. Allow the components to air-dry completely before reassembling. Reinstall the components and check for proper operation before running the boat in water.

#### LAUNCH PROCEDURE:

1. Turn the power "ON" to the transmitter and then the boat (in that order).
2. Gently place the boat in water that is at least 8" [200mm] deep and free of obstacles (weeds, rocks, sticks, ducks, muskrats, etc.).
3. Slowly advance the throttle to full speed and note if the boat has a tendency to turn right or left. Adjust the steering trim knob on your transmitter until the boat runs in a straight line when the steering wheel is at neutral.
4. When finished running, be sure to turn the power "OFF" to your boat and then the transmitter (in that order).

#### THE WAITING GAME

If your Reef Racer 2 should happen to stall, water currents will *slowly* carry it to shore. The bad news is that the boat could be carried to the opposite shore. When surveying areas to run your Reef Racer 2, keep variables in mind such as wind direction, size of the lake, strength of river currents, etc.

#### HELPFUL TIP:

Use a fishing rod with at least 12 lb. line and a tennis ball tied to the end to retrieve a stalled boat.

#### GOOD LUCK AND GREAT BOATING!

### MAINTENANCE

It is important to periodically (every 10-15 battery packs) remove the drive and rudder shafts and re-lubricate them with a thin coat of petroleum jelly or light grease. This procedure will require a 1.5mm hex driver. **Make sure that power to the boat is "OFF" during this procedure.**

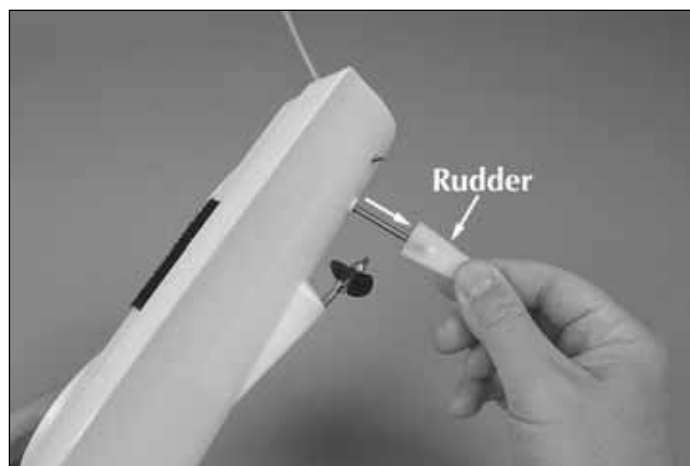
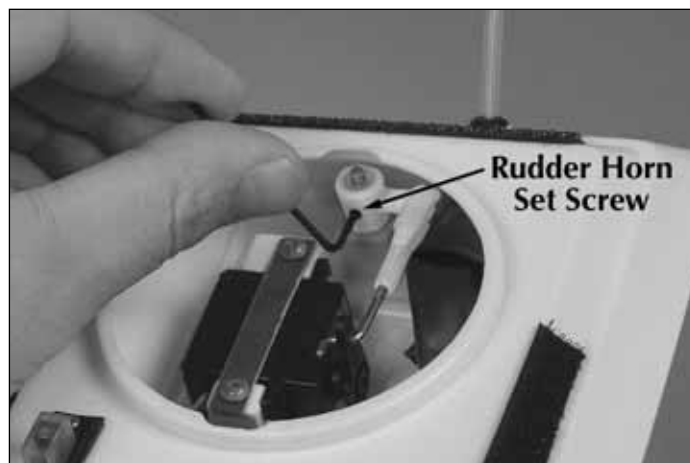

1. Twist the rear hatch lid until the tabs line up with the slots and gently lift the lid from the deck and locate the rudder horn as shown. Use a 1.5mm Allen wrench to loosen the rudder horn set screw and pull the rudder away from the hull.

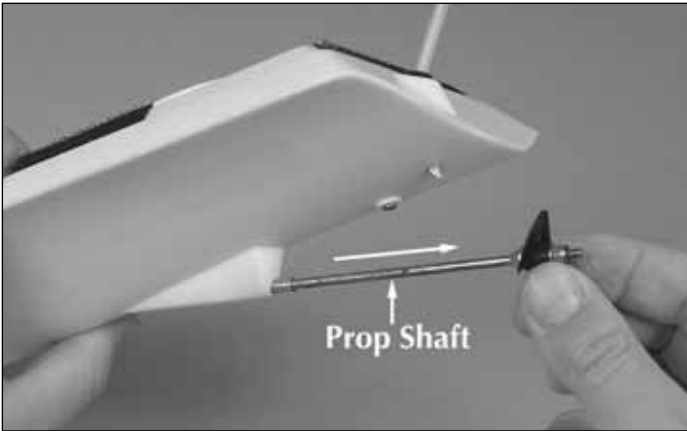
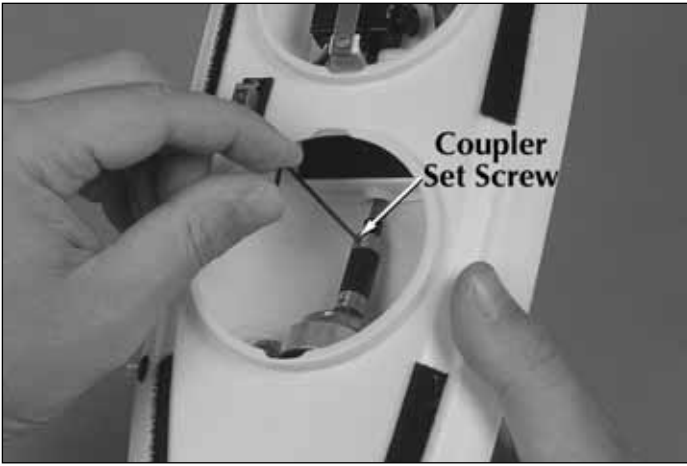

- 2. Loosen the 1.5mm set screw located at the rear of the drive coupler assembly, and pull the shaft out as shown.
- 3. After applying lubricant to the shaft, re-insert the shaft into the drive tube and rotate it while slowly pushing it back into place.
- 4. Re-tighten the 1.5mm set screw on the coupler assembly, making sure that the set screw rests on the flat spot of the drive shaft.
- 5. Apply a small amount of lubricant to the rudder shaft and re-install the rudder and the rudder arm. Re-tighten the 1.5mm rudder arm set screw.

### ORDERING REPLACEMENT PARTS

To order replacement parts for the AquaCraft Reef Racer 2, use the order numbers in the **Replacement Parts List** that follows. Replacement parts are available only as listed and can be purchased from hobby shops or mail order/ Internet order firms. Hardware items (screws, nuts, bolts) are also available from these outlets. If you need assistance locating a dealer to purchase parts, visit [www.hobbico.com](http://www.hobbico.com) and click on "Where to buy". If this kit is missing parts, contact **Hobbico Product Support** at:

**Phone: 217-398-8970**  
**Fax: 217-398-7721**  
**E-mail: [productsupport@hobbico.com](mailto:productsupport@hobbico.com)**

### REPLACEMENT PARTS LIST

<u>Order #</u>	<u>Item</u>
HCAB6312 .....	Decal Sheet
HCAB6400 .....	Deck Lids (2)
HCAB6458 .....	White Canopy
HCAB6459 .....	Blue Canopy
HCAB6460 .....	Red Canopy
HCAB6461 .....	Yellow Canopy
HCAB6462 .....	Purple Canopy
HCAB6463 .....	Orange Canopy
HCAB7755 .....	Propeller Set
HCAB7756 .....	Driveshaft
HCAB8707 .....	Rudder w/Control Arm
HCAG1061 .....	180 Motor w/ Connectors
HCAM3500 .....	7.2V 1100mAh Battery Pack
HCAM3501 .....	Rx/ESC Channel A1
HCAM3502 .....	Rx/ESC Channel A2
HCAM3503 .....	Rx/ESC Channel A3
HCAM3504 .....	Rx/ESC Channel A4
HCAM3505 .....	Rx/ESC Channel A5
HCAM3506 .....	Rx/ESC Channel A6
HCAP9919 .....	12V Field Charger
HCAZ3025 .....	Instruction Manual

### RACING

Although it is very enjoyable to go out and run the Reef Racer 2 by yourself, we think the real fun and excitement is experienced when you get involved in *RACING!*

Racing does not have to be an organized and sanctioned competition to be fun. In fact, small informal races can be very exciting without the stress that comes with formal events.

Here are some suggestions for setting up a simple racecourse for boats:

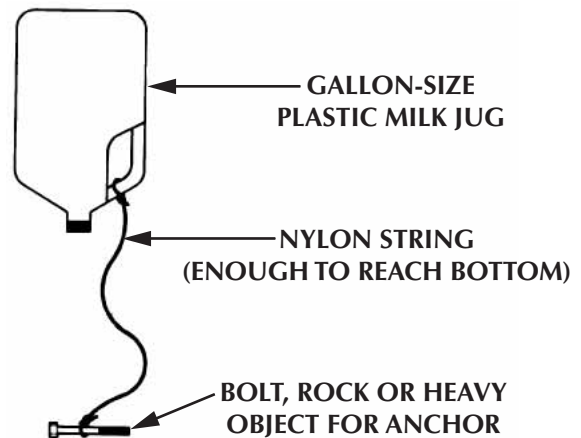

- Make 2 to 4 simple and inexpensive "marker buoys" with empty milk jugs, string and heavy objects for anchors, similar to the above sketch.

**SAMPLE "DRAG RACING" COURSE**

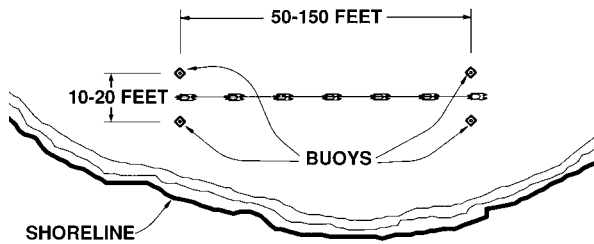

- For "drag racing" place the buoys similar to the above sketch.

**SAMPLE "OVAL" RACE COURSE**

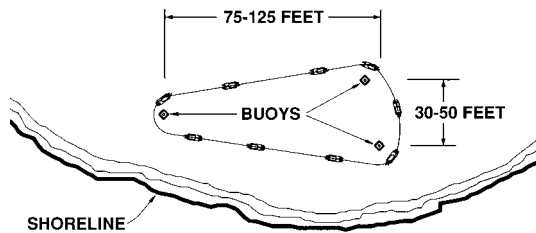

- For "oval racing" place the buoys similar to the above sketch. **NOTE:** The above patterns are not based on any sort of official standards; therefore, you may set up racecourses any way you desire, using your imagination to make the races more interesting. Usually the smaller courses will provide more action and excitement.

The length of the races can be determined by a set number of **laps** around the buoys (for example, the first boat to complete 5 laps is the winner); or by **time** (for example, whoever is leading at the end of two minutes is the winner).

**CHECK OUT THESE OTHER SENSATIONAL AQUACRAFT BOATS!**

**PARADISE**

**AquaCraft™ Paradise™ RTR**

Length: 26 in (660mm)

Its high-quality fiberglass hull sets it apart from other entry-level boats - quick and easy final assembly enables you to set sail in no time! The hull is already trimmed and painted, the nylon sails are preprinted, ballast is installed and the rigging is in place, ready for connection. A 2-stick radio by Futaba® provides precise sail and rudder control; a unique display stand ensures that the Paradise will draw admiring looks whether on dry land or on the water! Requires 12 "AA" batteries. **HCAB01\*\***

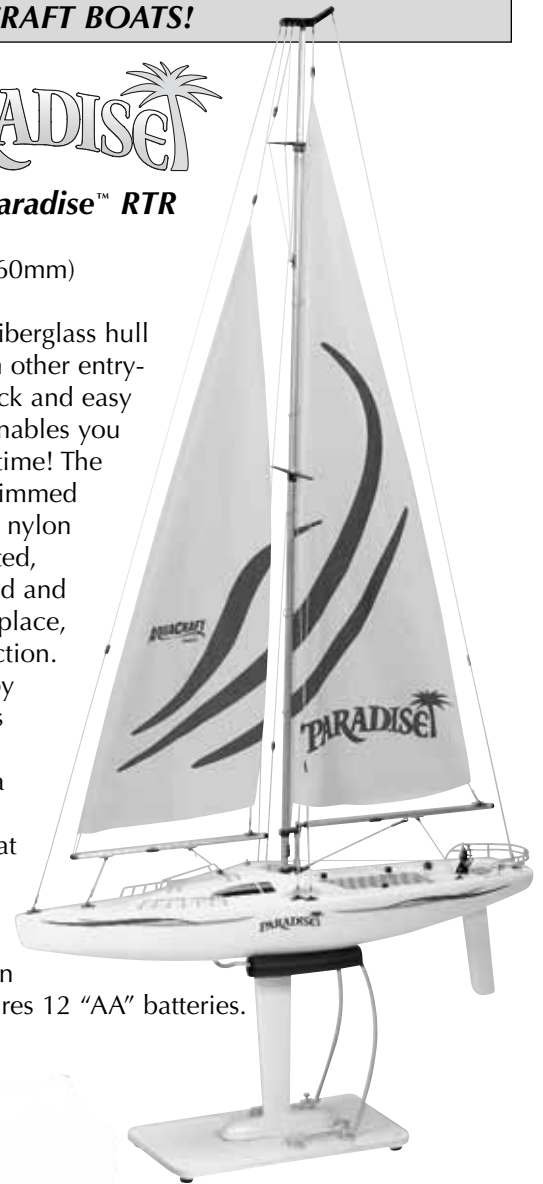

**PROFISHERMAN BASS BOAT**



**AquaCraft™ Pro Fisherman™ RTR**

From a distance, it would be easy to mistake the Pro Fisherman for the real thing. It sits on a display stand that looks like a custom tow-behind, even to having the same sparkle metallic finish as the boat. Look on deck, and you'll find swiveling seats and a trolling motor in the bow. Check out the stern, and you'll find a big EP outboard that hides a water-cooled 550 motor and bearing-supported drive train. Includes a 2-channel radio made by Futaba®, reversible ESC, push-pull steering linkage and a choice of six colorful finishes! Requires a 6-7 cell battery, charger and 8 "AA" cells. Length: 26.2" (665mm). **HCAB11\*\***

CHECK OUT THESE OTHER SENSATIONAL AQUACRAFT BOATS!



## **BRISTOL BAY**

**ELECTRIC R/C READY-TO-RUN FISHING BOAT**

### **AquaCraft™ Bristol Bay RTR**

From the real cloth sails to the simulated wood deck, the 33.5" (850mm) Bristol Bay offers the look of a working fishing vessel. Authentic scale details are painted and applied; the fiberglass hull is painted and the cabin features working mast and cabin lights. It takes only minutes to install the mast and connect the rigging and only a few more to install batteries. Everything else is already ship-shape, including a 550 motor, direct drive system, reversible ESC and gear for the included 2-channel pistol radio by Futaba®. Requires a 6-cell battery, charger & 10 "AA" batteries. **HCAB60\*\***



### **AquaCraft™ Hammer™ EP RTR**

"Strike hard, strike fast" - that's the Nitro Hammer's slogan, but it's good for this 24" (610mm) electric, too. Batteries are the only thing you need to buy or install; everything else is already covered: assembly, finishing, a display stand and more. Gear for the AquaCraft 2-channel radio is installed, as is a water-cooled 550 motor and ESC w/reverse. Great for all skill levels and available in six exciting colors. Requires a 6- or 7-cell battery, charger and 8 "AA" cells. **HCAB10\*\***



### **AquaCraft™ Nitro Hammer™ GP RTR**

Factory-built and finished in one of six custom colors, the Nitro Hammer includes virtually everything needed for high-speed fun: an AquaCraft 2-channel radio by Futaba®, a fuelproof fiberglass hull, engine stand, power-boosting tuned pipe and a FREE video that shows you how to break-in and maintain the included, recoil-started AquaCraft .15 Marine engine. Just 24" (610mm) long, the Nitro Hammer requires 20% glow fuel, a glow starter and 12 "AA" batteries. **HCAB26\*\***

Check us out on the web at [www.aquacraftmodels.com](http://www.aquacraftmodels.com) and watch for more exciting AquaCraft releases coming soon!