

ANTES DE COMENZAR, RECOPILE TODO EL MATERIAL DE APOYO PARA EL MONTAJE: Instrucciones de montaje / ilustraciones paso a paso / planos y plantillas impresos a escala.

PREPARACIÓN DEL MATERIAL: Para poder identificar correctamente las piezas precortadas, antes de extraerlas de las planchas de madera, marque en ellas la misma numeración que aparece en la hoja "IP" (identificación de piezas), incluida en las instrucciones.

INICIO DEL MONTAJE: Con la ayuda de un cúter y procurando no colocar los dedos en la línea de corte, desprenda las piezas de las planchas eliminando los pequeños nervios que las sujetan. Seguidamente lije con suavidad las piezas con papel de lija de grano fino, para eliminar el repelo de las mismas. El orden numérico del paso a paso indica el orden de elaboración y colocación de las piezas. Es importante comprobar el ajuste de las piezas antes de pegarlas definitivamente.

LISTONES Y VARILLAS: Los modelos incorporan varios tipos de listones y varillas para elaborar las diferentes piezas. La lista de piezas proporciona información sobre el tipo de material y medidas. En algunos casos es conveniente ajustar las medidas sobre el propio modelo, conforme avanzamos en el montaje. De esta manera se consigue un mejor ajuste.

PEGAMENTOS RECOMENDADOS: Cola blanca o de carpintero. Para las uniones de piezas de madera y de todas aquellas piezas que no ofrezcan resistencia.

Pegamento rápido. Para piezas que sean difíciles de sostener y que necesiten un secado casi instantáneo.

Cola de contacto o de zapatero. Para todas aquellas piezas que se forren con chapas finas de madera o metal. En todos los casos, lea siempre las instrucciones de uso del fabricante.

SERVICIO DE ATENCIÓN AL CLIENTE: Para cualquier duda o información sobre el montaje de nuestros productos, puede contactar con nuestro Servicio Técnico en la dirección:

www.occre.com. Le atenderemos con mucho gusto.

BEFORE STARTING, MAKE SURE YOU HAVE ALL THE SUPPORT MATERIAL FOR ASSEMBLING THE MODEL:

Assembly Instructions / Step by step pictures / Plans and templates printed to scale.

PREPARING THE MATERIAL: In order to correctly identify the precut parts, before removing them from the wooden sheets, mark on them the same numbers that appear on the "IP"

(Part Identification) Sheet included with the instructions.

STARTING THE ASSEMBLY: Using a cutter, and making sure you do not put your fingers along the cutting line, remove the parts from the wooden sheets, eliminating the small sprues that hold them in place. In continuation smoothly sand down the parts, using fine grain sandpaper, to eliminate the pickup of the parts. The numerical order indicates the order in which the different parts must be made up and fitted.

STRIPS AND RODS: These models incorporate a variety of different types of strips and rods with which to make up the different parts of the kit. The list of parts proportions information on the type of material and measurements. In some cases it is advisable to adjust the measurements on the basis of the model itself, as assembly progresses. In this way you will achieve a better fit.

RECOMMENDED GLUES: White, or carpenter's glue: For joining pieces of wood together. Mainly used for gluing together the skeleton. Quick-drying glue. For parts that are difficult to hold in their final position and which need to set instantly. Recommended for fitting small parts. Contact or cobbler's glue. For gluing into place the parts that are covered with fine wood veneer to set instantly. In all cases, always follow the manufacturer's recommendations.

CUSTOMER ATTENTION SERVICE: In the case of whatsoever doubt or further information that you may require regarding the assembly of our products, please contact our Technical Service online at the address: www.occre.com. We will be delighted to attend to you.

AVANT DE COMMENCER, VÉRIFIEZ TOUT LE MATÉRIEL DE SOUTIEN POUR LE MONTAGE:

PRÉPARATION DU MATÉRIEL: Pour pouvoir identifier correctement les pièces prédécoupées, avant de les extraire des planches de bois, inscrivez sur elles la même numérotation qui apparaît sur la page « IP » (identification des pièces) comprise dans les instructions.

DÉBUT DU MONTAGE: À l'aide d'un cutter, et en essayant de ne pas poser les doigts sur la ligne de découpe, séparez les pièces des planches en éliminant les petits nerfs qui les retiennent. Puis poncez doucement les pièces à l'aide d'un papier de verre à grain fin, pour éliminer le contrefil. L'ordre numérique des étapes photographiques et des plans indique l'ordre d'élaboration et d'installation des pièces.

LISTEAUX ET BAGUETTES: Les modèles intègrent plusieurs types de listeaux et de baguettes destinés à confectionner les différentes pièces. La liste des pièces indique le type de matériau et les dimensions des pièces. Il est parfois recommandé d'ajuster les mesures sur le modèle lui-même, au fur et à mesure que nous avançons dans le montage. De cette manière, on obtient un meilleur réglage.

COLLES RECOMMANDÉES: Colle blanche ou de menuisier: Pour les unions de pièces en bois et de toutes les pièces qui n'offrent pas de résistance. Colle à séchage rapide: Pour les pièces qui sont difficiles à maintenir dans leur position et qui requièrent un séchage pratiquement instantané. Colle de contact ou de cordonnier: Pour toutes les pièces qui sont recouvertes de fines plaques de bois ou de métal. Dans tous les cas, lisez toujours les instructions d'utilisation du fabricant.

SERVICE CLIENT: Pour toute question ou information concernant le montage de nos produits, vous pouvez contacter notre Service Technique à l'adresse suivante: www.occre.com.

Nous répondrons avec plaisir à vos questions.

PRIMA D'INIZIARE, RIUNIRE TUTTO IL MATERIALE D'APPOGGIO PER IL MONTAGGIO: Istruzioni di montaggio, immagini passo per passo, planimetrie e modelli stampati in scala.

PREPARAZIONE DEL MATERIALE: Per poter identificare in maniera corretta i pezzi che sono stati ritagliati, prima di estrarli dai blister di legno occorre segnarli con la stessa numerazione che è indicata nella pagina "IP" (Identificazione pezzi) che si trova nelle istruzioni.

INIZIO DEL MONTAGGIO: Con l'aiuto di un cutter, ed evitando di collocare le dita lungo la linea di taglio, separare i pezzi dai blister eliminando i piccoli nervi che li mantengono attaccati.

In seguito, scartavetrare con delicatezza i pezzi, utilizzando una carta vetrata a grana fine, onde eliminare le sbavature degli stess. L'ordine numerico del passo per passo indica l'ordine d'elaborazione e di collocazione dei pezzi. È importante verificare che questi combacino bene, prima d'incollarli definitivamente.

ASTE E BACCHETTE: I modelli sono dotati di vari tipi di aste e bacchette per formare i diversi pezzi. L'elenco dei pezzi offre informazioni sul tipo di materiale e sulle misure. In alcuni casi è conveniente modificarne le misure quando sono sul modello, man mano che si avanza nel montaggio. In questo modo si potrà ottenere che combacino meglio.

COLLE RACCOMANDATE: Colla bianca o da falegname: Per unire tra loro i pezzi in legno e tutti quei pezzi che non presentino resistenza. Colla rapida: Per i pezzi difficili da sostenere e per i quali sia necessaria un'asciugatura quasi istantanea. Colla a contatto o da calzolaio: Per tutti quei pezzi che vengono rivestiti con fine lastre di legno o di metallo. In ogni caso, leggere sempre le istruzioni d'uso del produttore.

SERVIZIO ASSISTENZA CLIENTE: Per qualsiasi dubbio o informazione sul montaggio dei nostri prodotti, contattare il nostro Servizio Tecnico al seguente indirizzo: www.occre.com.

Seremo lieti di potervi aiutare.

BEVOR SIE MIT DEM ZUSAMMENBAU BEGINNEN, LEGEN SIE SICH BITTE ALLE HILFSMATERIALIEN FÜR DIE MONTAGE BEREIT:

Bastelanleitung / Maßstabgerechte Skizzen und Schablonen / Skizzen und Vorlagen.

VORBEREITUNG DER MATERIALIEN: Damit die einzelnen Bauteile korrekt zugeordnet werden können, empfehlen wir, auf den Holzplättchen vor dem Herausnehmen mit einem Bleistift die Nummer auf dem Blatt IP (Identifikation Teile) zu markieren.

BEGINN DES ZUSAMMENBAUS: Die Teile mit einem Schneidwerkzeug (Cutter) herauslösen und die kleinen Befestigungsenden entfernen. Dabei darauf achten, die Finger nicht zu verletzen. Danach die Teile vorsichtig mit feinem Schmirgelpapier säubern, um ausgefranste Ränder zu entfernen. Die Nummernfolge der Schritte auf Fotos und Skizzen gibt an, in welcher Reihenfolge die Teile zusammengebaut werden.

LEISTEN UND STÄBE: Die Modelle enthalten mehrere Arten von Leisten und Stäben, aus denen die einzelnen Teile des Bausatzes geformt werden. In einigen Fällen kann es angebracht sein, die Maße im Zuge des Zusammenbaus entsprechend dem Modell anzupassen. Auf diese Weise wird eine bessere Passform erricht.

EMPFOHLENE KLEBSTOFFE: Weißleim (Tischlerleim): Zum Kleben von Strukturteilen und allen nachgiebigen Teilen. Sekundenkleber: Für schwer zu haltende Teile, die schnell verklebt werden müssen. Kontaktkleber (Schusterleim): Für alle Teile, die mit dünnen Holz- oder Metallstücken zum Beplanken oder Verkleiden beklebt werden. Bitte beachten Sie stets die Hinweise des Herstellers.

UNSER KUNDENDIENST: Bei Fragen zum Aufbau unserer Modelle steht Ihnen unser Kundendienst zur Verfügung. Sie erreichen uns online unter: www.occre.com.

Wir stehen Ihnen gern mit Rat und Tipps zur Verfügung.

INSTRUCCIONES DE MONTAJE TERROR

A- Siguiendo el orden alfanumérico inserte y pegue las piezas indicadas en las figuras. Antes de encolar las cuadernas, verifique que encajan correctamente en su posición haciendo "tope" en los encajes correspondientes de la falsa quilla. Es importante que las cuadernas queden completamente perpendiculares a la falsa quilla para que posteriormente encajen bien las cubiertas. Para esta operación utilice como adhesivo cola blanca, (cola de carpintero).

Trace una línea longitudinal que divida la cubierta **A20** en dos mitades simétricas. Comience a forrar ajustando la primera tira a la línea de lápiz. Utilice como adhesivo cola de contacto, (cola de zapatero). Sitúe las chapas **A22** sobre la plantilla para cortarlas a medida. Después, péguelas hasta completar la cubierta.

Con el mango de madera de una herramienta, frote fuertemente las chapas contra la cubierta para que se adhieran con firmeza. Coloque la cubierta bocabajo y corte los sobrantes de las chapas. Después, trace unas líneas para simular la tablazón. Lije la cubierta y aplíquela laca tapa-poros incolora.

B- Pegue la cubierta **A20** forrada sobre la estructura del barco. Es importante que la cubierta se apoye correctamente sobre las cuadernas. Para este proceso utilice un pegamento rápido. Introduzca las piezas **B1** y **B2** en agua para que recuperen flexibilidad. Utilice algún objeto cilíndrico para curvarlas poco a poco sin romperlas. Después, tiña la cara interior de las piezas con tinte al agua de color sapelli o similar. Adapte y pegue las piezas **B1** y **B2** con cola blanca y puntas. El clavador es una herramienta **OcCre (opcional)**, que se utiliza para sujetar y clavar al mismo tiempo las puntas.

C- Coloque el casco boca abajo y comience a lijar empezando desde proa y avanzando hacia popa. Debe desbastar los tacos de refuerzo y las aristas de las cuadernas pero sin deformar su forma original. El lijado del casco ha de quedar simétrico, es decir, que el lateral derecho ha de quedar igual que el izquierdo. Para la zona media del casco, utilice un taco lijador con mayor superficie. El lijado debe ser progresivo y suave.

Compruebe con un listón, que el lijado es correcto. Para ello, debe deslizar el listón, sobre las cuadernas, para ver como se ajusta a su forma. Tome los listones **C1** y sumérjalos en agua unos veinte minutos. Con esta operación, recuperarán flexibilidad. Después, séquelos con un paño y forre el espejo del casco. Comience el forrado del casco ajustando el primer listón a la parte inferior de la amurada. Observe las imágenes siguientes antes de proceder. Debe pegar los listones a las cuadernas y entre sí con cola blanca y fijarlos con puntas.

Pegue otro listón a continuación del primero, que llegue hasta popa. Continúe el mismo proceso para forrar el casco entero. Deberá cortar a medida y ajustar las piezas para que encajen en los huecos.

Si en algún punto le ha quedado alguna traca suelta, puede aplicar pegamento de secado rápido. Si le ha quedado alguna traca más hundida, pegue otra encima y después, lijela. Pegue los refuerzos **C3**, **C4** y **C5** y **C6**. Lime las cabezas de las puntas hasta que queden enrasadas con el forro. Después, lije todo el casco. Debe quedar suave y sin desniveles.

D- Utilizando como adhesivo, cola de contacto, (cola de zapatero), coloque el forro **D1**. Este segundo forro, se coloca de la misma manera que el primero. Debe cerrar los huecos con cuñas y frotar las chapas con firmeza para que se adhieran al casco. A medida que avance con el forro, abra los orificios que las amuradas tienen de origen. Procure que las tiras de forro queden lo más juntas posible para conseguir un buen acabado. Lije todo el casco con lija de grano fino para dejar su superficie uniforme.

E- Pegue los listones **E1** de tres en tres hasta completar la longitud total del casco. Péguelos con pegamento de secado rápido. Observe la figura de la plantilla para apreciar la cantidad de listones que debe colocar para conseguir este refuerzo. Después, lije para conseguir la forma precisa. Tiña las piezas **E3** a **E9** y de color sapelli o similar. Tiña también las piezas **E14** a **E16** de color sapelli. Añada las piezas que le indican las imágenes. Después, lije las piezas añadidas y aplique laca tapa-poros incolora.

F- Confeccione y pegue las piezas **F1** a **F5**. Pinte de tonos azulados el fondo del espejo y pegue encima las ventanas **F2**. Lije y tiña de color sapelli, la pieza **F6**, después, barnícela. Ajuste y pegue las bisagras **F7** y los ejes **F8**. Deberá realizar orificios para insertar las puntas **A**. Péguelas con pegamento rápido. Pinte la pieza **F19** de color oro y la pieza **F26** de color negro. Utilice la plantilla **PL-01** para realizar los orificios y poder insertar y pegar las piezas **F29** en la cubierta. Elabore y tiña las piezas de cubierta con tinte de color sapelli o similar. Después, pegue las piezas que le muestran las imágenes de esta fase.

G- Utilizando como guía las medidas de las imágenes, trace en el casco el patrón que le servirá para pegar las chapas **G1**.

Con unas tijeras, corte las chapas de aluminio **G1** en dos mitades longitudinales. Después, vuelva a cortarlas por la mitad, de esta manera obtendrá cuatro piezas de una misma chapa. Utilice unos alicates para enderezarlas y/o curvarlas. Ajústelas con un taco lijador o una lima. Deberá lijar la superficie del casco y la cara de las chapas que harán contacto entre si. Utilice cola de contacto, (cola de zapatero). Después de colocar las chapas **G1**, será el momento de pintar el casco, si es que desea hacerlo. Deberá lijar la superficie de las chapas y del casco para ello. Es aconsejable, que utilice pinturas acrílicas al agua con acabado satinado. Elabore y fije las demás piezas que le indican las imágenes.

H-I- Construya los tambuchos y fórrelos con las chapas de sapelli. Coloque los elementos utilizando como guía, la plantilla suministrada. Deberá pintar las chimeneas de color negro y destacar sus relieves de color oro. Pinte también las barcas de color marrón por el interior, y blanco por el exterior. Es aconsejable, utilizar pinturas acrílicas al agua con acabado satinado. Tiña las piezas **X**, **Z** e **Y** de color roble y construya con ellas el soporte para el barco.

ARBOLADURA

Para elaborar los mástiles, el primer paso a seguir será cortar las varillas según las medidas que indica la lista de piezas, o bien tomarlas directamente de los planos que están impresos a escala 1/1.

Todos los mástiles y vergas tienen cierta conicidad que se deberá realizar.

Para realizar la conicidad a los mástiles, lije las varillas, (con un lijador), aumentando el desgaste de ésta a medida que se acerca al extremo donde se quiere disminuir el diámetro. Haga rodar la varilla para que el desgaste sea igual por todo el contorno hasta conseguir llegar al diámetro que indica el plano.

Para elaborar la conicidad de las vergas, realice las mismas operaciones, pero esta vez a ambos extremos de la varilla.

Deberá teñir o pintar las varillas en función del modelo que esté construyendo.

Para realizar correctamente los mástiles de este modelo se deberá tener en cuenta:

Los planos, las fotos de detalle de los mástiles, las medidas y descripción de materiales de la lista de piezas y las hojas "IP" de identificación de piezas.

Los mástiles se deberán barnizar y algunas de las piezas que los componen se deberán pintar. Véanse las fotos generales de detalle de los mástiles.

Una vez montados y barnizados, deberán colocarles los aparejos, (estrobos, cuadernales, cáncamos, motones, etc.), y fijarlos al barco.

Los mástiles se deben introducir hasta hacer tope en los encajes de la falsa quilla.

JARCIA

Para elaborar la jarcia de este barco, siga el orden alfabético de las figuras impresas de los planos, que indican el orden de colocación: de hilos, vigo-tas, motones, velas, etc, destacados en color rojo. La lista de piezas le orientara sobre el tipo de materiales y medidas a utilizar.

Para simular el envejecido de las velas, se les puede dar un baño con infusión de té, sin hacerlas hervir, y dejarlas secar bien arrugadas. Se colocaran sin planchar para que tengan cuerpo.

ASSEMBLY INSTRUCTIONS TERROR

A: Following the alphanumeric order, fit and glue the parts indicated in the photos and drawings. Before gluing the frames into place make sure that they have been correctly fitted “snugly” into position on the corresponding slots in the false keel. It is important to make sure that the frames are completely perpendicular to the false keel, in order to ensure that the decks fit correctly. Use white (or carpenter’s) glue as the adhesive for this operation. Using a pencil, draw a lengthways line to divide the deck (A20) into two symmetrical halves. Start to line the deck with the planking, aligning the first strip along the pencil line. Use contact (or cobbler’s) adhesive. Place the planking strips (A22) over the template, so that they can be cut to size, and then glue them in place to make up the deck.

With the wooden handle of a tool vigorously press the planking strips against the deck, making sure they are firmly glued in place. Now place the deck upside down on your work surface and trim off all of the excess planking strips. Now mark lines and dots to simulate plank ends and nail heads.

B: Glue the deck (A20), now lined, onto the structure of the ship. It is important to ensure that the deck is resting correctly on the frames. For this process use fast-setting glue. Now soak parts (B1 & B2) in water, so that they recover their flexibility and, using a cylindrical object, bend them to shape, making sure that you don’t break them. Now stain the interior side of these pieces a sapelli-colour or similar. Adapt and glue parts (B1 & B2) into place using white glue and pins. The nailer is an (optional) OcCre tool, which can be used to simultaneously hold and drive home the pins, or nails.

C: Place the hull upside down and start to sand it, working from the bow towards the stern. You must sand down the reinforcements and the edges of the frames, although without deforming their original shape. The sanding down of the hull must be symmetrical, i.e. the right side must end up the same as the left side. In the middle of the hull use a sanding block with a bigger surface area. Sanding down needs to be done progressively and gently.

Line up a strip to ensure that the sanded finish is correct. To this end you should slide the strip over the edges of the frames to verify that it adapts to the form. Take the strips (C1) and soak them in water for around 20 minutes, which will enable them to recover a certain flexibility, then dry them using a cloth and use them to line the hull transom. Start to line the hull by fitting first strip flush up against the bottom of the bulwarks. Check the images before going ahead with this operation. The strips must be glued to the frames and to each other, using white glue, and then fixed in place using pins.

Now glue another strip alongside the first, and so on all the way to the stern. Continue with this process until you have lined the whole of the hull.

You will have to cut the strips to size and adjust the parts so that they fit into the gaps.

If, at any point, you detect that one or more of the strips is loose, correctly align it and apply fast-setting glue. If any of the strips is sunken, in comparison with the others, then glue another one on top of it and sand it down until it is flush. Now glue the reinforcement parts (C3, C4, C5 & C6) into place, as shown. File down the pin heads until they are flush with the hull, and then sand down the whole of the hull. Make sure that it presents a smooth finish without variations in level.

D: Using contact (cobbler’s) adhesive, glue the lining planks (D1) into place. This second layer of planking should be fitted in the same way as the first. Any gaps that may be left must be filled with lengths sharpened at both ends. Press them down firmly so that they stick securely to the hull. As the lining work progresses reopen the original holes in the bulwarks. Make sure that the strips of planking are aligned as close together as possible, to ensure a good finish. Now gently sand down the whole of the hull leaving a uniform surface finish.

E: Glue the strips for the strake (E1), three at a time, along the full length of the hull, using fast-setting glue. Check out the template in the image to see how many strips need to be fitted to make up the strake. Now sand them down to achieve the precise shape. Stain parts (E3 - E9) a sapelli-coloured or similar. Also stain the parts (E14 - E16) a sapelli-colour or similar. Attach all of the other parts indicated in the images, and then sand down the added parts and apply a coat of colourless, pore-filler lacquer.

F: Make up and glue the parts (F1 - F5) into place. Paint the transom in shades of blue and then glue the windows (F2) into place. Sand down the part (F6), stain it sapelli-colour and then varnish it. Fit and glue the hinges (F7) and the hinge-pins (F8) into place. You will have to make holes for the pins (A), use fast-setting glue. Paint the part (F19) gold, and the part (F26) black. Use the template PL-01 to make the holes so that you can insert part (F29) and glue it to the deck. Make up and stain the deck pieces sapelli-colour stain, or similar. Now glue the parts shown in the images for this phase into place.

G: Using the sizes indicated in the images as a guide, trace the template onto the hull so that it can serve for gluing the metal sheets (G1) into place. Using scissors, cut the aluminium sheets (G1) lengthways into two halves, and then cut them in half again, making four quarter parts for each sheet, using pliers to straighten and/or bend them to shape. Now sand or file down the edges using a sanding block or file. You will have to sand down the surface of the hull and the sides of the metal sheets that come into contact with each other. Use contact (cobbler’s) adhesive. Now fit the metal sheets (G1) into place, this would be the moment to paint the hull, if you wish to do so, after first sanding down both the sheets and hull. The use of water-based, satin-finish acrylic paints is recommended. Make up and fit into place the other pieces shown in the images.

H-I: Make up the lockers and line them using the sheets of sapelli wood. Fit these elements in place using the template supplied as a guide. The chimneys must be painted black, highlighting the reliefs in gold. Also paint the launch brown on the inside and white on the outside. The use of water-based acrylics with a satin finish is recommended. Stain the parts (X, Z & Y) with oak stain and use them to make up the stand for the ship.

MASTS AND SPARS

In order to make up the masts the first step is to cut the rods to size, as indicated in the parts list, or by taking measurements directly from the plans, which are printed in 1/1 scale.

All of the masts and spars have to have a certain conical shape, which they will have to be given.

In order to achieve this conical shape for the masts, sand down the rod (using a sander), increasing the amount of sanding down as you get closer to the end at which you want to decrease the diameter. Turn the rod so that you sand it down evenly on all sides, until achieving the diameter indicated in the plan.

To achieve this conical shape for the spars carry out the above operations but in this case evenly reducing the diameter at both ends of the rod.

The rods will have to be stained or painted, depending on the model that you are building.

To correctly make up the mast for this model you must take into account:

The plans, the close-up photos of the masts and spars, the measurements and material descriptions of the parts list, the “PI” parts identification sheets.

The masts and spars need to be varnished, while some of the parts that make them up are meant to be painted. Examine the general and close-up photos of the masts.

Once the mast and spars has been assembled and varnished fix the tackle (slings, blocks, eyebolts, clump blocks, etc.) into place on the ship. The masts will have to be fully inserted into the sockets prepared to receive them in the false keel.

SAILS AND RIGGING

In order to make up the running gear for this ship follow the alphabetic order of the images printed on the plans, indicating the order for fitting the (ropes, clump blocks, blocks, sails, etc.) highlighted in red. In combination with the parts list this will serve as a guide with regard to the type of material to be used and the measurements.

A method for simulating the aging of the sails is to soak them in an infusion of tea, without boiling, and then leaving them to dry all wrinkled up. Fit them in place without ironing so that they will have a certain consistency.

INSTRUCTIONS DE MONTAGE TERROR

A- Introduire et coller les pièces indiquées sur les figures en suivant l'ordre alphanumérique. Avant de coller les couples, vérifier qu'ils s'emboîtent correctement à leur place et qu'ils pénètrent à fond dans les emboîtures de la fausse quille. Il est important que les couples soient parfaitement perpendiculaires à la fausse quille afin que les ponts s'emboîtent correctement par la suite. Pour réaliser cette opération, on utilisera de la colle blanche (colle de menuisier).

Tracer une ligne longitudinale qui divise le pont A20 en deux moitiés symétriques. Commencer le bordage en plaçant la première latte contre la ligne tracée au crayon. Utiliser de la colle de contact (colle de cordonnier). Placer les plaques A22 sur le patron afin de les couper sur mesure. Ensuite, coller ces plaques de sorte à couvrir tout le pont.

Frotter énergiquement les plaques contre le pont, à l'aide du manche en bois d'un outil, afin qu'elles y adhèrent fermement. Retourner le pont et couper les excédents des plaques. Tracer ensuite des lignes pour simuler le bordage. Poncer le pont et y appliquer un vernis bouche-pores incolore.

B- Coller le pont A20 bordé sur la structure du bateau. Il est important que le pont repose correctement sur les couples. On utilisera de la colle rapide pour réaliser cette opération. Plonger les pièces B1 et B2 dans l'eau afin qu'elles récupèrent leur flexibilité. Utiliser un objet cylindrique pour les courber petit à petit en évitant de les briser. Ensuite, teinter la face intérieure des pièces en utilisant une teinture à l'eau de couleur sapelli ou semblable. Adapter et coller les pièces B1 et B2 avec de la colle blanche et des pointes. La cloueuse est un outil OcCre (option) qui sert à tenir et à clouer en même temps les pointes.

C- Retourner la coque et la poncer en allant de la proue vers la poupe. Il faut dégrossir les taquets de renfort et les arêtes des couples, mais en veillant à ne pas modifier leur forme originale. Le ponçage de la coque doit être symétrique, c'est-à-dire que le côté droit doit être identique au côté gauche. Pour la zone du milieu de la coque, utiliser une cale à poncer plus grande. Le ponçage doit être progressif et doux.

Vérifier à l'aide d'un listeau que le ponçage est correct. À cet effet, faire glisser le listeau sur les couples afin de voir s'il s'adapte bien à leur forme. Prendre les listeaux C1 et les plonger dans l'eau pendant vingt minutes environ. Cela leur permettra de récupérer leur flexibilité. Ensuite, sécher les listeaux à l'aide d'un chiffon et border le tableau de la coque. Commencer le bordage de la coque en ajustant le premier listeau à la partie inférieure de la muraille. Observer les photos suivantes avant de réaliser cette opération. Il faut coller les listeaux sur les couples et entre eux en utilisant de la colle blanche, puis les fixer avec des pointes.

Coller contre le premier listeau un autre listeau qui ira jusqu'à la poupe. Continuer le même processus de sorte à border toute la coque. Il faut couper les pièces sur mesure et les ajuster afin qu'elles s'emboîtent dans les ouvertures.

Si l'on observe une latte lâche, on peut appliquer de la colle à séchage rapide. Si l'on observe une latte enfoncée, on collera une autre latte par-dessus, puis on la dégrossira. Coller les renforts C3, C4 et C5 et C6. Limer la tête des pointes de sorte qu'elles soient de niveau avec le bordé. Ensuite, poncer toute la coque. Elle doit être douce et ne pas présenter de dénivellations.

D- Placer le bordé D1 en utilisant de la colle de contact (colle de cordonnier). Placer ce deuxième bordé de la même façon que le premier. Il faut obturer les ouvertures à l'aide de cales et frotter les plaques de façon énergique afin qu'elles adhèrent à la coque. On percera les ouvertures originales des murailles au fur et à mesure que le bordage avancera. Veiller à ce que les bandes de bordé soient les plus proches possible afin d'obtenir une bonne finition. Poncer toute la coque avec du papier de verre à grain fin de sorte à obtenir une surface uniforme.

E- Coller les listeaux E1 par groupe de trois de sorte à couvrir toute la longueur de la coque. Coller ces pièces avec de la colle à séchage rapide. Observer la figure du patron afin de voir la quantité de listeaux qu'il faut placer pour obtenir ce renfort. Ensuite, poncer pour obtenir la forme précise. Teinter les pièces E3 à E9 de couleur Sapelli ou semblable. Teinter également les pièces E14 à E16 de couleur Sapelli. Ajouter les pièces qui sont indiquées sur les photos. Ensuite, poncer les pièces ajoutées et appliquer un vernis bouche-pores incolore.

F- Assembler et coller les pièces F1 à F5. Peindre dans des tons bleus le fond du tableau et coller par-dessus les fenêtres F2. Poncer et teinter la pièce F6 en couleur Sapelli puis vernir. Ajuster et coller les charnières F7 et les axes F8. Il faudra percer des orifices pour introduire les pointes A. Coller ces pièces en utilisant de la colle rapide. Peindre la pièce F19 en doré et la pièce F26 en noir. Utiliser le patron PL-01 pour percer les orifices et pour introduire et coller les pointes F29 sur le pont. Assembler et teinter les pièces du pont avec une teinture couleur Sapelli ou semblable. Ensuite, coller les pièces indiquées sur les photos de cette étape.

G- En utilisant comme guide les dimensions des photos, tracer sur la coque le patron qui servira à coller les plaques G1.

Couper les plaques en aluminium G1 en deux moitiés longitudinales à l'aide de ciseaux. Ensuite, couper de nouveau ces pièces en deux de sorte à obtenir quatre pièces à partir d'une même plaque. Utiliser une pince pour les redresser et/ou les plier. Ajuster ces pièces à l'aide d'une cale à poncer ou d'une lime. Il faudra poncer la superficie de la coque et la face des plaques qui seront en contact. Utiliser de la colle de contact (colle de cordonnier). Après avoir placé les plaques G1, on pourra peindre la coque si on le souhaite. Pour ce faire, il faudra poncer la superficie des plaques et de la coque. On recommande d'utiliser des peintures acryliques à l'eau avec une finition satinée. Assembler et fixer les autres pièces qui sont indiquées sur les photos.

H-I- Construire les écouteilles et les border avec les plaques de sapelli. Placer les éléments en utilisant le patron fourni comme guide. Il faut peindre les cheminées en noir et faire ressortir leurs reliefs en doré. Peindre également l'intérieur des barques en brun et l'extérieur en blanc. On recommande d'utiliser des peintures acryliques à l'eau avec une finition satinée. Teinter les pièces X, Z et Y en couleur chêne et construire avec celles-ci le support du bateau.

MÂTURE

La première chose à faire pour confectionner les mâts est de couper les baguettes aux dimensions indiquées dans la liste des pièces ou de prendre ces mesures directement des plans qui sont imprimés à l'échelle 1/1.

Tous les mâts et les vergues possèdent une certaine conicité qui doit être travaillée.

Pour réaliser la conicité des mâts, poncer les baguettes (avec une ponceuse) en augmentant le dégrossissage au fur et à mesure qu'on s'approche de l'extrémité où l'on souhaite diminuer le diamètre. Faire rouler la baguette afin que l'usure soit égale sur tout le contour jusqu'à ce qu'on obtienne le diamètre indiqué sur le plan.

Effectuer les mêmes opérations pour réaliser la conicité des vergues mais, dans ce cas, aux deux extrémités de la baguette.

Il faudra teinter ou peindre les baguettes en fonction de la maquette qui sera construite.

Pour réaliser correctement les mâts de cette maquette, il faudra tenir compte :

Des plans, des photos de détail des mâts, des dimensions et de la description des matériaux de la liste des pièces, des feuilles « IP » d'identification des pièces.

Les mâts devront être vernis et certaines des pièces qui les composent devront être peintes. Voir les photos générales de détail des mâts.

Lorsque les mâts seront montés et vernis, on placera leurs apparaux (estropes, moufles, pitons, poulies, etc.) et on les attachera au bateau. Les mâts doivent être introduits de sorte qu'ils s'emboîtent à fond contre la fausse quille.

GRÉEMENT

Pour réaliser le gréement de ce bateau, on suivra l'ordre alphabétique des figures imprimées des plans, qui indiquent l'ordre de montage (fils, caps de mouton, poulies, etc.) mis en évidence en rouge. La liste des pièces indique le type de matériaux et les dimensions à utiliser.

Pour simuler le vieillissement des voiles, on peut les faire tremper dans une infusion de thé, sans les faire bouillir, et les laisser sécher bien chiffonnées. Les voiles seront placées non repassées afin d'avoir du volume.

ISTRUZIONI DI MONTAGGIO **TERROR**

A- Seguendo l'ordine alfanumerico, inserire e incollare i pezzi indicati nelle figure. Prima d'incollare il corbame, verificare che s'incastri in maniera corretta nella sua posizione, combaciando nei corrispondenti incastri della falsa chiglia. È importante che il corbame sia completamente perpendicolare alla falsa chiglia affinché in seguito si possano incastrare bene i ponti. Per realizzare questa operazione, utilizzare come adesivo una colla bianca (colla da falegname).

Tracciare una linea longitudinale che divida il ponte **A20** in due metà simmetriche. Iniziare e a ricoprire, incollando la prima striscia lungo la linea tracciata a matita. Utilizzare come adesivo una colla a contatto (colla da calzolaio). Posizionare le lastre **A22** sulla sagoma, per poterle tagliare su misura. In seguito, incollarle fino a completare il ponte.

Con il manico di legno di un utensile, sfregare con forza le lastre contro il ponte affinché aderiscano in maniera ben ferma. Collocare il ponte al rovescio e ritagliare le parti eccedenti delle piastre. In seguito, tracciare delle linee per simulare il tavolato. Scartavetrare il ponte e applicare una vernice turapori incolore.

B- Incollare il ponte **A20** rivestito sulla struttura del vascello. È importante che il ponte sia appoggiato in maniera corretta sulle coste. Per realizzare questa operazione, utilizzare una colla a presa rapida. Introdurre i pezzi **B1** e **B2** in acqua, affinché acquistino una certa flessibilità. Utilizzare un qualsiasi oggetto cilindrico per dargli la curvatura poco a poco, senza romperli. In seguito, verniciare la parte interna dei pezzi con una vernice all'acqua in colore sapelli o simile. Adattare e incollare i pezzi **B1** e **B2** con colla bianca e chiodini. La chiodatrice è un utensile **OcCre (opzionale)**, che si utilizza per sostenere e inchiodare i chiodini allo stesso tempo.

C- Collocare lo scafo al rovescio e iniziare a scartavetrare cominciando dalla prua e andando verso la poppa. Si devono levigare i tasselli di rinforzo e gli angoli delle coste, ma senza deformarne la loro forma originale. La scartavetratura dello scafo deve dare un risultato simmetrico, quindi il costato destro deve essere uguale a quello sinistro. Per la zona centrale dello scafo, utilizzare una carta vetrata con maggior superficie. La levigatura deve essere progressiva e delicata.

Controllare con una listarella che la levigatura sia corretta. Per realizzare questa operazione, si deve far passare la listarella sulle coste per verificare come si adatta alla loro forma. Prendere le listarelle **C1** e immergerle in acqua per circa 20 minuti, in maniera tale che acquistino flessibilità. Quindi asciugarle con un panno e rivestire lo specchio dello scafo. Iniziare a rivestire lo scafo adattando la prima listarella alla parte inferiore della murata. Osservare le immagini seguenti prima di iniziare il lavoro. Bisogna incollare le listarelle alle coste, e tra loro, con colla bianca, e fissarle con i chiodini. Incollare una listarella dopo l'altra, a seguito della prima, fino ad arrivare alla poppa. Realizzare la stessa operazione fino a ricoprire tutto lo scafo. I pezzi devono essere ritagliati su misura e adattati affinché ricoprano tutti gli spazi vuoti.

Se in qualche punto è rimasta qualche listarella non ben aderita, si può applicare una colla ad asciugatura rapida. Se qualche listarella è rimasta un po' affondata, si può incollarne un'altra sopra e poi scartavetrare. Incollare i rinforzi **C3**, **C4** e **C5** e **C6**. Scartavetrare le testine dei chiodini finché non siano a filo con il rivestimento. Poi, levigare tutto lo scafo. Il risultato finale deve essere una superficie liscia e senza dislivelli.

D- Utilizzando come adesivo una colla a contatto, (colla da calzolaio), collocare il rivestimento **D1**. Questo secondo rivestimento si colloca allo stesso modo del primo. Si devono chiudere le fessure con cunei e fregare le piastre con forza affinché aderiscano bene allo scafo. A misura che si avvanzi con il rivestimento, aprire i fori che le murate presentano in origine. Fare attenzione che le listarelle di rivestimento siano il più possibile unite, per ottenere una buona finitura. Levigare tutto lo scafo con una carta vetrata a grana fine per ottenere una superficie uniforme.

E- Incollare le listarelle **E1** tre alla volta per completare la lunghezza totale dello scafo. Incollarli con colla ad asciugatura rapida. Osservare la figura del modello per calcolare la quantità di listarelle che si devono collocare per ottenere questo rinforzo. In seguito, levigare per ottenere la forma precisa. Verniciare i pezzi da **E3** a **E9** in colore sapelli o simile. Verniciare anche i pezzi da **E14** a **E16** in colore sapelli. Aggiungere i pezzi indicati nelle immagini. In seguito, scartavetrare i pezzi aggiunti ed applicare una vernice turapori incolore.

F- Montare e incollare i pezzi **F1** a **F5**. Verniciare in toni blu il fondo dello specchio e incollarci sopra le finestre **F2**. Scartavetrare e verniciare in colore sapelli, il pezzo **F6**; in seguito, verniciarlo. Adattare e incollare le cerniere **F7** e gli assi **F8**. Si dovranno realizzare dei fori per inserire i chiodini **A**. Incollarli con colla rapida. Verniciare il pezzo **F19** in colore oro e il pezzo **F26** in colore nero. Utilizzare la maschera **PL-01** per realizzare i fori e poter inserire e incollare i pezzi **F29** nel ponte. Preparare e verniciare i pezzi del ponte con vernice in colore sapelli o simile. In seguito, incollare i pezzi indicati nelle immagini di questa fase.

G- Utilizzando come guida le misure delle immagini, tracciare sullo scafo la maschera che servirà per incollare le piastre **G1**.

Con delle forbici, ritagliare le piastre d'alluminio **G1** in due metà longitudinali. In seguito, ritagliarle a metà in maniera tale da ottenere quattro pezzi da una sola piastra. Utilizzare delle pinze per prepararle e/o curvarle. Adattarle con l'uso di carta vetrata o di una lima. Si dovrà scartavetrare la superficie dello scafo e la superficie delle piastre che saranno in contatto tra loro. Utilizzare una colla a contatto (colla da calzolaio). Dopo aver collocato le piastre **G1**, sarà il momento di verniciare lo scafo, se si desidera. Per farlo, si dovrà scartavetrare la superficie delle piastre e dello scafo. È consigliabile utilizzare delle vernici acriliche ad acqua con finitura satinata. Preparare e fissare gli altri pezzi indicati nelle immagini.

H-I- Realizzare i tambuci e rivestirli con le piastre in sapelli. Collocare gli elementi utilizzando, come guida, la maschera appositamente fornita. I comignoli devono essere dipinti in nero e i rilievi in oro. Verniciare anche le barche in marrone all'interno ed in bianco all'esterno. È consigliabile utilizzare vernici acriliche all'acqua, con finitura satinata. Verniciare i pezzi **X**, **Z** e **E** in color rovere e realizzare con questi i supporti per il vascello.

ALBERATURA

Per realizzare l'alberatura, il primo passo da seguire sarà quello di tagliare le aste secondo le misure indicate nell'elenco dei pezzi, oppure prenderle direttamente dalle planimetrie che sono stampate in scala 1/1.

Tutti gli alberi e i pennoni hanno una certa conicità che si dovrà ottenere.

Per ottenere la conicità degli alberi, occorre scartavetrare le aste (con una smerigliatrice), aumentando l'azione della stessa a misura che ci si avvicina all'estremità dove si deve diminuire il diametro. Far girare l'asta affinché la smerigliatura sia uguale su tutto il contorno, fino ad arrivare al diametro indicato nella planimetria.

Per ottenere la conicità dei pennoni, realizzare le stesse operazioni, ma in questo caso su entrambe le estremità dell'asta. Si dovranno verniciare o tingere le aste in funzione del modello che si stia realizzando.

Per realizzare gli alberi di questo modello in maniera corretta si dovranno utilizzare:

Le planimetrie; le foto dettagliate degli alberi; le misure e la descrizione dei materiali nell'elenco dei pezzi; le pagine "IP" con l'identificazione dei pezzi.

Gli alberi devono essere smaltati ed alcuni dei pezzi che li compongono devono essere verniciati. Vedi le foto generali dettagliate degli alberi.

Una volta montati e smaltati, devono essere collocati gli attrezzi (stroppi, quarnali, golfare, bozzelli, ecc.) e fissati al vascello. Gli alberi devono essere introdotti fino in fondo negli appositi incastri della falsa chiglia.

SARTIA

Per elaborare la sartia di questo vascello occorre seguire l'ordine alfabetico delle figure stampate delle planimetrie, che indicano l'ordine di collocazione delle cime, delle bigotte, dei bozzelli, delle vele, ecc., risaltati in colore rosso. L'elenco dei pezzi serve ad orientare in merito al tipo di materiali ed alle misure da utilizzare.

Per simulare l'invecchiamento delle vele, queste possono essere bagnate con tè, senza farle bollire, e poi lasciarle asciugare mantenendole ben arrugate. Poi si collocano senza stirarle, affinché mantengano corpo.

BASTELANLEITUNG TERROR

A- Die auf den Abbildungen gezeigten Teile in der angegebenen Reihenfolge einsetzen und aufkleben. Vor dem Aufkleben der Spanten sicherstellen, dass die sie korrekt sitzen und mit den dazugehörigen Einkerbungen des falschen Kiels abschließen. Die Spanten müssen vollkommen senkrecht auf dem falschen Kiel stehen, damit danach die Decks gut eingesetzt werden können. Für diese Operation muss weißer Kleber (Tischlerleim) verwendet werden.

Eine Längslinie ziehen, mit der das Deck **A20** in zwei symmetrische Hälften geteilt wird. Dabei die erste Plankenreihe an der Bleistiftlinie ausrichten. Zum Kleben Kontaktkleber verwenden (Schusterleim). Die Leisten **A22** zum Zurechtsutzen auf die Schablone legen. Anschließend aufkleben, um das Deck abzuschließen.

Mit dem Holzstiel eines Werkzeugs das Furnier kräftig auf das Deck reiben, bis es fest haftet. Das Deck bäuchlings aufsetzen und die überstehenden Teile der Leisten abschneiden. Abschließend Linien ziehen und Markierungen anbringen, um die Schiffsbeplankung zu simulieren. Das Deck glatt schmirgeln und mit farblosem porenschließendem Lack behandeln.

B- Das beplankte Deck **A20** auf die Struktur des Schiffes kleben. Dabei darauf achten, dass das Deck richtig auf den Spanten sitzt. Dazu Sekundenkleber verwenden. Die Teile B1 und B2 in Wasser einweichen, damit sie biegsamer werden. Die Teile dann vorsichtig mit einem zylinderförmigen Gegenstand formen. Anschließend die Innenseite der Teile mit Wasserfarbe in Sapelly-Farbe oder ähnlich anmalen. Die Teile **B1** und **B2** anpassen und mit weißem Leim und Stiften anbringen. Der Nagler ist ein von **OcCre** als Zubehör angebotenes Werkzeug, um die Stifte festzuhalten und gleichzeitig festzunageln.

C- Den Rumpf mit der Oberseite nach unten anbringen und vom Bug in Richtung Heck glattschmirgeln. Die Verstärkungskeile und die Kanten der Spanten glätten, aber dabei nicht die ursprüngliche Form verändern. Beim Glätten des Rumpfs darauf achten, dass beide Seiten symmetrisch zueinander sein müssen. Für den mittleren Rumpfbereich einen Sander mit großer Schleifoberfläche verwenden. Die Oberfläche nach und nach vorsichtig glätten.

Mit der Leiste testen, ob eine gleichmäßige Oberfläche hergestellt wurde. Dazu die Leiste über die Spanten fahren und prüfen, wie sie sich der Form anpasst. Die Leisten **C1** ca. 20 Minuten in Wasser einweichen, damit sie biegsam werden. Anschließend mit einem Tuch trockenreiben und den Spiegel des Rumpfs damit verkleiden. Mit der Wegerung des Schiffsrumpfs beginnen und dazu die erste Leiste an der Unterseite der Schanzverkleidung ankleben. Vor dem Weitermachen die Abbildungen beachten. Die Leisten an die Spanten kleben und dazwischen mit weißem Leim die Stifte ankleben.

Eine weitere Leiste neben die erste kleben und auf dieselbe Weise bis zum Heck fortfahren. Den ganzen Rumpf auf diese Weise beplanken. Die Teile für die Zwischenräume nach Maß zurechtschneiden.

Lose Planke mit Sekundenkleber festkleben. Wenn eine Planke zu tief sitzen sollte, eine weitere Planke darüber kleben und anschließend nachbearbeiten. Die Verstrebungen **C3**, **C4** und **C5** und **C6** aufkleben. Die Stiftköpfe glattfeilen, bis sie auf einer Höhe mit den Plankenreihen sind. Anschließend den gesamten Rumpf glatt schmirgeln. Es muss eine glatte und gleichmäßige Oberfläche entstehen.

D- Kontaktkleber (Schusterleim) verwenden, um die Beplankung **D1** aufzukleben. Diese zweite Beplankung wird auf die gleiche Weise wie die erste verlegt. Die Zwischenräume mit Schlusskeilen abschließen und die Leisten fest andrücken, damit sie am Rumpf anhaften. Die Planken, die die Öffnungen der Schanzverkleidung verdecken, während des Wegerns nach und nach öffnen. Für ein gleichmäßiges Finish darauf achten, dass die Plankenreihen so nah wie möglich nebeneinander sitzen. Danach die Teile vorsichtig mit feinem Schmirgelpapier bearbeiten, so dass eine gleichmäßige Oberfläche entsteht.

E- Die Leisten **E1** in Dreiergruppen aufkleben, bis der Rumpf auf ganzer Länge bedeckt ist. Mit Sekundenkleber festkleben. An der Schablone sieht man, wie viele Leisten zur Rumpfverstärkung angebracht werden müssen. Anschließend mit Schmirgelpapier in die passende Form bringen. Die Teile **E3** bis **E9** in Sapelly-Farbe oder ähnlich anmalen. Die Teile **E14** bis **E16** auch in Sapelly-Farbe anmalen. Die Teile, die auf den Abbildungen zu sehen sind, aufkleben. Anschließend die angeklebte Teile glatt schmirgeln und mit farblosem porenschließendem Lack behandeln.

F- Die Teile **F1** bis **F5** anfertigen und aufkleben. Den Untergrund des Spiegels blau-grau anmalen und darauf die Fenster **F2** kleben. Teil **F6** glatt schmirgeln und mit Sapelly-Farbe anmalen und anschließend lackieren. Die Scharniere **F7** und die Achsen **F8** anpassen und aufkleben. Öffnungen zum Einsetzen der Stifte A anbringen. Mit Sekundenkleber aufkleben. Teil **F19** goldfarben und Teil **F26** schwarz anmalen. Mithilfe der Schablone **PL-01** die Öffnungen anbringen und die Teile **F29** am Deck einsetzen und festkleben. Die Deckteile anfertigen und in Sapelly-Farbe oder ähnlich färben.

Anschließend die Teile, die auf den Abbildungen dieses Blatts gezeigt werden, aufkleben.

G- Die auf den Abbildungen angegebenen Maße ansetzen und ein Muster auf den Rumpf zeichnen, auf das dann die Leisten **G1** geklebt werden. Mit einer Schere die Alu-Leisten **G1** der Länge nach in zwei Hälften schneiden. Anschließend noch einmal durchschneiden, so dass sich aus einer Leiste vier Teile ergeben. Zum Zurechtziehen und Biegen eine Zange verwenden. Mit einem Sander oder einer Feile glätten. Die Oberfläche des Rumpfs und die Seiten der Leisten, die am Rumpf sitzen, glattschmirgeln. Dazu Kontaktkleber (Schusterleim) verwenden. Nach Anbringen der Leisten **G1** den Rumpf lackieren, wenn dies gewünscht wird. Dazu vorher die Oberflächen von Leisten und Rumpf glattschmirgeln. Es wird empfohlen, Acrylfarbe auf Wasserbasis mit satiniertem Finish verwenden. Die übrigen Teile, die auf den Abbildungen zu sehen sind, anfertigen und befestigen.

H-I- Die Deckluken anfertigen und mit den Leisten in Sapelly-Farbe verkleiden. Die Teile anbringen, die mitgelieferte Schablone als Führung verwenden. Die Schornsteine schwarz anmalen, und die Ringe goldfarben absetzen. Die Innenseite der Boote braun und die Außenseite weiß anmalen. Es wird empfohlen, Acrylfarben auf Wasserbasis mit satiniertem Finish verwenden. Die Teile **X**, **Z** und **Y** eichenholzfarben anmalen und daraus den Ständer für das Schiffsmodell anfertigen.

BEMASTUNG

Zur Herstellung der Masten müssen zuerst die Stäbe entsprechend der Maße zurecht geschnitten werden, die in der Teileliste angegeben sind oder die direkt anhand der Skizze abgemessen wurde. Die Skizzen sind im Maßstab 1/1 angefertigt.

Alle Masten und Rahen müssen leicht konisch verlaufen und vor dem Einbau entsprechen vorbereitet werden.

Um die Masten in Konusform zu bringen, müssen die Masten (mit einer Feile) zurecht geschliffen werden, und zwar in der Form, dass sie nach oben hin verjüngt werden. Die Stäbe dabei drehen und an allen Seiten gleichmäßig abschleifen, bis sie zu dem auf der Skizze angegebenen Durchmesser passen.

Um die Rahen in Konusform zu bringen, ebenso verfahren, allerdings hier an beiden Enden der Stangen.

Die Stäbe in Abhängigkeit von dem Modell färben oder anmalen.

Um die Masten dieses Schiffsbaumodells richtig vorzubereiten, müssen die folgenden Punkte beachtet werden:

Die Skizzen, detailfotos der Masten, maße und Materialien der Teileliste, IP-Blätter zur Identifikation der Bauteile.

Die Masten müssen lackiert werden und einige der Einzelteile der Masten müssen angemalt werden. Siehe Fotos mit allgemeiner Ansicht der Masten

Nach Aufstellung und Lackierung der Masten wird die Takelung (Stroppe, Rollenblöcke, Ösen, Blockrollen etc.) an den Masten und dann am Schiff befestigt. Die Masten müssen eingesetzt werden, bis sie an die Einkerbungen des falschen Kiels stoßen.

TAKELAGE

Zur Takelung des Schiffsmodells die alphabetische Reihenfolge der Abbildungen befolgen, auf denen die Anbringung der Takelung (Faden, Klampböcke, Blockrollen usw.) erläutert wird. Sie sind in Rot hervorgehoben. Auf der Teileliste sehen Sie, welche Materialien zum Bau des Modells notwendig sind.

Zur künstlichen Alterung der Segel die Stoffstücke in Tee legen (nicht kochen) und trocknen lassen, bis die Stoffe faltig werden. Die Segel ohne vorheriges Bügeln anbringen, damit sie Volumen haben.

A- Следуя указанному буквами и цифрами порядку вставьте и приклейте детали, указанные на рисунках. Перед тем как нанести клей на шпангоуты, проверьте правильность их пригонки к соответствующим пазам фальшкиля. Очень важно обеспечить полную перпендикулярность шпангоутов к фальшкилю, чтобы впоследствии можно было установить правильно палубы. Для этой операции используйте в качестве клеящего средства белый клей (сапожный клей).

Нанесите продольную линию, разделяющую палубу A20 на две симметричные половины. Начните обшивку, пригоняя первую полосу к нанесенной карандашом линии. Используйте в качестве клеящего вещества контактный клей (сапожный клей). Разместите пластины A22 на шаблоне для их обрезки по размеру. Затем приклейте их до завершения палубы.

Деревянной ручкой какого-нибудь инструмента притрите с силой пластины к палубе, чтобы они прочно прикрепились. Положите палубу верхом книзу и обрежьте лишние части пластин. Затем начертите несколько линий, чтобы обозначить настил. Зачистите палубу и нанесите на нее бесцветный порозаполняющий лак.

B- Приклейте обшитую палубу A20 к структуре корабля. Важно, чтобы палуба как следует опиралась на шпангоуты. Для этого процесса используйте быстросохнущий клей. Поместите детали B1 и B2 в воду, чтобы восстановить их гибкость. Используя цилиндрический предмет, осторожно согните их, не допуская разлома. Затем окрасьте внутреннюю сторону деталей водяным красителем цвета Sapelli или аналогичным ему. Придайте и приклейте детали B1 и B2, используя белый клей и гвоздей. Гвоздильный молоток является инструментом OcCre (дополнительным), который используется для удержания и одновременно прибавления гвоздей.

C- Положите корпус верхом книзу и начните зачистку, продвигаясь от носа к корме. Вам нужно обтесать подпорки усиления и выступы шпангоутов, не нарушая при этом их изначальную форму. Результат зачистки должен быть симметричным, то есть, правая боковина должна быть равна левой. Для центральной зоны корпуса используйте шлифовальный брусок с большей поверхностью. Зачистка должна производиться поступательно и без нажима. При помощи планки проверьте правильность шлифовки. Для этого вам нужно провести планкой по шпангоутам, убеждаясь, что они соответствуют его форме. Возьмите планки C1 и погрузите их в воду примерно на двадцать минут. Эта операция восстановит их гибкость. Затем высушите их при помощи сукна и обшейте транцевую корму корпуса. Начните обшивку корпуса, пригнав первую планку к нижней части фальшборта. Перед исполнением ознакомьтесь со следующими изображениями. Вам нужно приклеить планки к шпангоутам и друг к другу при помощи белого клея и закрепить их гвоздями.

Приклейте следующую планку, следуя за первой, до самой кормы. Повторяйте те же действия для обшивки всего корпуса. Вам нужно вырезать по размеру и пригнать детали, чтобы они правильно входили в отверстия.

Если в каком-нибудь месте осталась отошедшая планка, вы можете нанести клей быстрого высыхания. Если какая-нибудь планка оказалась впавшей, наклейте сверху другую, а затем затешите ее. Наклейте усиления C3, C4 и C5 и C6. Зачистите головки гвоздей, чтобы они были вровень с обшивкой. Затем отшлифуйте весь корпус. Он должен быть гладким, без неровностей.

D- Используя в качестве клеящего средства контактный клей (сапожный клей), установите обшивку D1. Эта вторая обшивка устанавливается таким же способом, как и первая. Вам нужно закрывать полости клиньями и с усилием притирать пластины, чтобы они были вплотную к корпусу. По мере выполнения обшивки открывайте отверстия, изначально имеющиеся в фальшборте. Следите за тем, чтобы полосы обшивки находились как можно ближе друг к другу, чтобы облицовка была хорошего качества. Отшлифуйте весь корпус мелкозернистой шкуркой, чтобы поверхность была ровной.

E- Приклейте планки E1 по три по всей длине корпуса. Приклейте их клеем быстрого высыхания. Посмотрите рисунок шаблона, чтобы определить количество планок, которые нужно установить для достижения этого усиления. Затем отшлифуйте до получения точной формы. Окрасьте E3 - E9 цветом Sapelli или аналогичным ему. Окрасьте также детали E14 - E16 цветом Sapelli. Добавьте детали, как показано на рисунках. Затем отшлифуйте добавленные детали и нанесите бесцветный перезаполняющий лак.

F- Изготовьте и приклейте детали F1 - F5. Покрасьте в голубые тона открытую поверхность транцевой кормы и приклейте сверху иллюминаторы F2. Отшлифуйте и окрасьте цветом Sapelli деталь F6, затем покройте ее лаком. Пригоните и приклейте шарниры F7 и оси F8. Необходимо проделать отверстия, чтобы вставить гвозди A. Приклейте их быстросохнущим клеем. Покрасьте деталь F19 золотистым цветом и деталь F26 черным цветом. Используйте **PL-01** шаблон для проделывания отверстий и вставления и приклеивания деталей F29 на палубе. Подготовьте и окрасьте детали палубы краской цвета Sapelli или аналогичной. Затем приклейте детали, показанные на рисунках данной фазы.

G- Руководствуясь размерами на изображениях, нанесите на корпус линии, согласно которым вы будете наклеивать пластины G1. Вырежьте ножницами пластины из алюминия G1 в двух продольных половинах. Затем разрежьте их снова посередине, таким образом вы получите четыре детали из одной пластины. Используйте плоскогубцы для их распрямления или/и сгибания. Доработайте их наждачным бруском или напильником. Вы должны отшлифовать поверхность корпуса и сторону пластин, которые будут прилегать друг к другу. Используйте контактный клей (сапожный клей). После установки пластин G1 следует покрасить корпус, если вы этого желаете. Для этого вам нужно будет зачистить поверхность пластин и корпуса. Рекомендуется использовать акриловые краски на воде с глянцевой отделкой. Подготовьте и закрепите остальные детали, как показано на рисунках.

H-I- Изготовьте люки и обшейте их пластины Sapelli. Установите эти элементы, используя в качестве направляющей прилагаемый шаблон. Нужно покрасить трубы в черный цвет, выделяя выступающие части золотым цветом. Также покрасьте корабли в коричневый цвет с внутренней стороны и в белый – с внешней. Рекомендуется использовать акриловые краски на воде с глянцевой отделкой. Окрасьте детали X, Z и Y дубовым цветом и изготовьте из них подставку для корабля.

МАЧТЫ И РЕИ

Для подготовки мачт в первую очередь нужно нарезать стержни по размерам, указанным в перечне деталей, или взять их непосредственно с чертежей, напечатанных в масштабе 1:1.

Все мачты и реи обладают определенной конусностью, которую им нужно придать.

Для придания мачтам конусности, отшлифуйте стержни (наждачным бруском), увеличивая их стирание к тому концу, где требуется меньший диаметр.

Поворачивайте стержень, чтобы стирание было одинаковым по всему контуру до получения диаметра, указанного на чертеже

Для придания конусности реям выполните те же операции, но в этом случае на обоих концах стержня.

Вам нужно будет придать цвет или покрасить стержни в зависимости от изготавливаемой модели.

Для правильного изготовления мачт этой модели нужно принимать во внимание:

Чертежи

Подробные фотографии мачт

Размеры и описание материалов в перечне деталей

Листы "IP" с идентификацией деталей

Мачты нужно покрыть лаком, а отдельные составляющие их детали должны быть покрашены. Рассмотрите общие фотографии с подробностями мачт.

После того как они смонтированы и покрыты лаком, нужно установить на них оснастку (стропы, блоки, рым-болты, блоки и т.д.) и укрепить их на корабле. Мачты должны вставляться до упора в пазы фальшкиля.

ТАКЕЛАЖ









Для изготовления такелажа данного корабля следуйте в алфавитном порядке фигурам на чертежах, которые указывают порядок установки: канатов, юферсов, блоков, парусов, которые выделены красным цветом. Перечень деталей содержит сведения по виду применяемых материалов и размерам.

Для придания парусам старинного вида можно вымочить их в чайном настое, не кипятя, и высушить их не разглаживая. Они устанавливаются без разглаживания, чтобы они были объемными.

Lista de piezas / Parts List / Liste des pièces / Teilleiste / Elenco delle parti			
Nº/No./ Nº / Nr. / No	Cantidad / Quantity / Quantité / Menge/ Quantità	Medidas / Measurements / Dimensions / Maße / Misure	Material / Material / Matériau / Material / Materiale
A1	1	Precortado / Precut / Prédécoupé / Vorgeschnitten / Pretagliato	Tablero / Plywood / Planche / Sperrholz / Tavola
A2 - A7	6	Precortado / Precut / Prédécoupé / Vorgeschnitten / Pretagliato	Tablero / Plywood / Planche / Sperrholz / Tavola
A8	1	Precortado / Precut / Prédécoupé / Vorgeschnitten / Pretagliato	Tablero / Plywood / Planche / Sperrholz / Tavola
A9-A13	5	Precortado / Precut / Prédécoupé / Vorgeschnitten / Pretagliato	Tablero / Plywood / Planche / Sperrholz / Tavola
A14-A15	4	Precortado / Precut / Prédécoupé / Vorgeschnitten / Pretagliato	Tablero / Plywood / Planche / Sperrholz / Tavola
A16-A17	4	Precortado / Precut / Prédécoupé / Vorgeschnitten / Pretagliato	Tablero / Plywood / Planche / Sperrholz / Tavola
A18	2	Precortado / Precut / Prédécoupé / Vorgeschnitten / Pretagliato	Tablero / Plywood / Planche / Sperrholz / Tavola
A19	4	Precortado / Precut / Prédécoupé / Vorgeschnitten / Pretagliato	Tablero / Plywood / Planche / Sperrholz / Tavola
A20	1	Precortado / Precut / Prédécoupé / Vorgeschnitten / Pretagliato	Tablero / Plywood / Planche / Sperrholz / Tavola
A21	10	0,6x5x400	Sicomoro / Sycamore / Sycomore / Bergahorn / Sicomoro
A22	75	0,6x5x47	Sicomoro / Sycamore / Sycomore / Bergahorn / Sicomoro
B1	1	Precortado / Precut / Prédécoupé / Vorgeschnitten / Pretagliato	Tablero / Plywood / Planche / Sperrholz / Tavola
B2	2	Precortado / Precut / Prédécoupé / Vorgeschnitten / Pretagliato	Tablero / Plywood / Planche / Sperrholz / Tavola
C1-C2	72	2x5x600	Tilo / Lime wood / Tilleul / Linde / Tiglio
C3-C6	8	Precortado / Precut / Prédécoupé / Vorgeschnitten / Pretagliato	Tablero / Plywood / Planche / Sperrholz / Tavola
D1-D2	72	0,6x5x600	Sapelly / Sapelli / Sapelli / Sapelly-Holz / Tavola
E1	36	2x5x600	Tilo / Lime wood / Tilleul / Linde / Tiglio
E2	2	Precortado / Precut / Prédécoupé / Vorgeschnitten / Pretagliato	Tablero / Plywood / Planche / Sperrholz / Tavola
E3	1	Precortado / Precut / Prédécoupé / Vorgeschnitten / Pretagliato	Tablero / Plywood / Planche / Sperrholz / Tavola
E4	1	Precortado / Precut / Prédécoupé / Vorgeschnitten / Pretagliato	Tablero / Plywood / Planche / Sperrholz / Tavola
E5-E7	3	Precortado / Precut / Prédécoupé / Vorgeschnitten / Pretagliato	Tablero / Plywood / Planche / Sperrholz / Tavola
E8	1	Precortado / Precut / Prédécoupé / Vorgeschnitten / Pretagliato	Tablero / Plywood / Planche / Sperrholz / Tavola
E9	2	Precortado / Precut / Prédécoupé / Vorgeschnitten / Pretagliato	Tablero / Plywood / Planche / Sperrholz / Tavola
E10	10	0,6x5x50	Sapelly / Sapelli / Sapelli / Sapelly-Holz / Sapelli
E11	2	Precortado / Precut / Prédécoupé / Vorgeschnitten / Pretagliato	Tablero / Plywood / Planche / Sperrholz / Tavola
E12	1	Precortado / Precut / Prédécoupé / Vorgeschnitten / Pretagliato	Tablero / Plywood / Planche / Sperrholz / Tavola
E13	3	2x5x400	Tilo / Lime wood / Tilleul / Linde / Tiglio
E14-E16	8	Precortado / Precut / Prédécoupé / Vorgeschnitten / Pretagliato	Tablero / Plywood / Planche / Sperrholz / Tavola
E17	3	Preformado / Preformed/ Préformé / Vorgeformt / Preformato	Madera / Wood / Bois / Holz Legno
E18-E19	3	2x2x400	Tilo / Lime wood / Tilleul / Linde / Tiglio
E20	5	0,6x5x10	Sicomoro / Sycamore / Sycomore / Bergahorn / Sicomoro
F1	2	2x5x39	Tilo / Lime wood / Tilleul / Linde / Tiglio
F2	4	Preformado / Preformed/ Préformé / Vorgeformt / Preformato	Latón / Brass / Latón / Messing / Ottone
F3	2	2x2x14	Tilo / Lime wood / Tilleul / Linde / Tiglio
F4	2	2x5x15	Tilo / Lime wood / Tilleul / Linde / Tiglio
F5	1	2x5x78	Tilo / Lime wood / Tilleul / Linde / Tiglio
F6	1	Precortado / Precut / Prédécoupé / Vorgeschnitten / Pretagliato	Tablero / Plywood / Planche / Sperrholz / Tavola
F7	8	Preformado / Preformed/ Préformé / Vorgeformt / Preformato	Latón / Brass / Latón / Messing / Ottone
F8	4	ø1x6	Latón / Brass / Latón / Messing / Ottone
F9	2	Preformado / Preformed/ Préformé / Vorgeformt / Preformato	Metal / Metal / Metal / Metall / Metallo
F10-F11	2	Preformado / Preformed/ Préformé / Vorgeformt / Preformato	Latón / Brass / Latón / Messing / Ottone
F12-F18	13	Preformado / Preformed/ Préformé / Vorgeformt / Preformato	Latón / Brass / Latón / Messing / Ottone
F19	1	Preformado / Preformed/ Préformé / Vorgeformt / Preformato	Metal / Metal / Metal / Metall / Metallo
F20	4	2x4x44	Sapelly / Sapelli / Sapelli / Sapelly-Holz / Sapelli
F21	2	2x4x35	Sapelly / Sapelli / Sapelli / Sapelly-Holz / Sapelli
F22	1	2x4x22	Sapelly / Sapelli / Sapelli / Sapelly-Holz / Sapelli
F23	10	4x4x16	Sapelly / Sapelli / Sapelli / Sapelly-Holz / Sapelli
F24	2	2x4x20	Sapelly / Sapelli / Sapelli / Sapelly-Holz / Sapelli
F25	2	2x4x36	Sapelly / Sapelli / Sapelli / Sapelly-Holz / Sapelli
F26	1	Preformado / Preformed/ Préformé / Vorgeformt / Preformato	Metal / Metal / Metal / Metall / Metallo
F27	2	Precortado / Precut / Prédécoupé / Vorgeschnitten / Pretagliato	Tablero / Plywood / Planche / Sperrholz / Tavola
F28	1	2x4x27	Sapelly / Sapelli / Sapelli / Sapelly-Holz / Sapelli
F29	32	Preformado / Preformed/ Préformé / Vorgeformt / Preformato	Latón / Brass / Latón / Messing / Ottone
F30	1	Preformado / Preformed/ Préformé / Vorgeformt / Preformato	Metal / Metal / Metal / Metall / Metallo
F31	1	Preformado / Preformed/ Préformé / Vorgeformt / Preformato	Metal / Metal / Metal / Metall / Metallo
F32	2	4x4x10	Sapelly / Sapelli / Sapelli / Sapelly-Holz / Sapelli
F33	1	ø0,15x20	Hilo crudo / Raw thread / Fil brut / Rohes Baumwollfaden / Filo crudo
F34	8	2x5x15	Tilo / Lime wood / Tilleul / Linde / Tiglio
F35	4	2x2x5	Tilo / Lime wood / Tilleul / Linde / Tiglio
F36	4	4x4x15	Sapelly / Sapelli / Sapelli / Sapelly-Holz / Sapelli
F37	2	2x4x30	Sapelly / Sapelli / Sapelli / Sapelly-Holz / Sapelli
F38	4	4x4x7	Sapelly / Sapelli / Sapelli / Sapelly-Holz / Sapelli
F39	1	Preformado / Preformed/ Préformé / Vorgeformt / Preformato	Composite / Composite / Composite / Composite / Composite
F40	2	2x4x22	Sapelly / Sapelli / Sapelli / Sapelly-Holz / Sapelli
F41	2	2x4x21	Sapelly / Sapelli / Sapelli / Sapelly-Holz / Sapelli
F42	2	2x4x21	Sapelly / Sapelli / Sapelli / Sapelly-Holz / Sapelli
F43	2	2x3x8	Tilo / Lime wood / Tilleul / Linde / Tiglio
F44	2	2x3x12	Sapelly / Sapelli / Sapelli / Sapelly-Holz / Sapelli
F45	2	2x3x21	Sapelly / Sapelli / Sapelli / Sapelly-Holz / Sapelli
G1	30	Preformado / Preformed/ Préformé / Vorgeformt / Preformato	Metal / Metal / Metal / Metall / Metallo
G2	92	ø0,50x40	Latón / Brass / Latón / Messing / Ottone
G3	70	ø1x32	Latón / Brass / Latón / Messing / Ottone
G4	70	Preformado / Preformed/ Préformé / Vorgeformt / Preformato	Latón / Brass / Latón / Messing / Ottone
G5	2	5x5x28	Tilo / Lime wood / Tilleul / Linde / Tiglio
G6	2	4x4x24	Tilo / Lime wood / Tilleul / Linde / Tiglio
G7	2	Precortado / Precut / Prédécoupé / Vorgeschnitten / Pretagliato	Tablero / Plywood / Planche / Sperrholz / Tavola

<i>Lista de piezas / Parts List / Liste des pièces / Teileliste / Elenco delle parti</i>			
G8	4	Preformado / Prefomed/ Préformé / Vorgeformt / Preformato	Latón / Brass / Latón / Messing / Ottone
G9	2	Preformado / Prefomed/ Préformé / Vorgeformt / Preformato	Latón / Brass / Latón / Messing / Ottone
G10	2	2x4x15	Sapelly / Sapelli / Sapelli / Sapelly-Holz / Sapelli
G11	1	ø1,5x27	Latón / Brass / Latón / Messing / Ottone
G12	8	5x5x30	Tilo / Lime wood / Tilleul / Linde / Tiglio
G13	2	Precortado / Precut / Prédécoupé / Vorgeschnitten / Pretagliato	Tablero / Plywood / Planche / Sperrholz / Tavola
G14	1	ø1,5x15	Latón / Brass / Latón / Messing / Ottone
G15	1	Preformado / Prefomed/ Préformé / Vorgeformt / Preformato	Madera / Wood / Bois / Holz / Legno
G16	2	Preformado / Prefomed/ Préformé / Vorgeformt / Preformato	Metal / Metal / Metal / Metall / Metallo
G17	2	Preformado / Prefomed/ Préformé / Vorgeformt / Preformato	Latón / Brass / Latón / Messing / Ottone
G18	1	ø0,15x150	Hilo crudo / Raw thread / Fil brut / Rohes Baumwollfaden / Filo crudo
G19	2	4x4x5	Tilo / Lime wood / Tilleul / Linde / Tiglio
H1	1	Precortado / Precut / Prédécoupé / Vorgeschnitten / Pretagliato	Tablero / Plywood / Planche / Sperrholz / Tavola
H2	4	ø1x11	Latón / Brass / Latón / Messing / Ottone
H3	4	0,6x5x18	Sapelly / Sapelli / Sapelli / Sapelly-Holz / Sapelli
H4	1	Precortado / Precut / Prédécoupé / Vorgeschnitten / Pretagliato	Tablero / Plywood / Planche / Sperrholz / Tavola
H5-H6	4	Precortado / Precut / Prédécoupé / Vorgeschnitten / Pretagliato	Tablero / Plywood / Planche / Sperrholz / Tavola
H7	5	0,6x5x23	Sapelly / Sapelli / Sapelli / Sapelly-Holz / Sapelli
H8	1	Precortado / Precut / Prédécoupé / Vorgeschnitten / Pretagliato	Tablero / Plywood / Planche / Sperrholz / Tavola
H9-H10	4	Precortado / Precut / Prédécoupé / Vorgeschnitten / Pretagliato	Tablero / Plywood / Planche / Sperrholz / Tavola
H11	5	0,6x5x23	Sapelly / Sapelli / Sapelli / Sapelly-Holz / Sapelli
H12	2	Precortado / Precut / Prédécoupé / Vorgeschnitten / Pretagliato	Tablero / Plywood / Planche / Sperrholz / Tavola
H13-H14	8	Precortado / Precut / Prédécoupé / Vorgeschnitten / Pretagliato	Tablero / Plywood / Planche / Sperrholz / Tavola
H15	6	0,6x5x23	Sapelly / Sapelli / Sapelli / Sapelly-Holz / Sapelli
H16	4	ø1x18	Latón / Brass / Latón / Messing / Ottone
H17	2	0,6x5x12	Sapelly / Sapelli / Sapelli / Sapelly-Holz / Sapelli
H18	4	0,6x5x10	Sapelly / Sapelli / Sapelli / Sapelly-Holz / Sapelli
H19	3	2x4x19	Sapelly / Sapelli / Sapelli / Sapelly-Holz / Sapelli
H20	5	2x4x28	Sapelly / Sapelli / Sapelli / Sapelly-Holz / Sapelli
H21	1	Preformado / Prefomed/ Préformé / Vorgeformt / Preformato	Madera / Wood / Bois / Holz / Legno
H22	8	2x2x10	Tilo / Lime wood / Tilleul / Linde / Tiglio
H23	6	ø1x10	Latón / Brass / Latón / Messing / Ottone
H24	1	Preformado / Prefomed/ Préformé / Vorgeformt / Preformato	Metal / Metal / Metal / Metall / Metallo
H25	5	1x4x25	Tilo / Lime wood / Tilleul / Linde / Tiglio
H26	1	ø0,15x200	Hilo crudo / Raw thread / Fil brut / Rohes Baumwollfaden / Filo crudo
H27	10	ø3x45	Tilo / Lime wood / Tilleul / Linde / Tiglio
H28	10	ø3x40	Tilo / Lime wood / Tilleul / Linde / Tiglio
H29	1	ø0,15x100	Hilo crudo / Raw thread / Fil brut / Rohes Baumwollfaden / Filo crudo
H30	2	ø1x64mm	Latón / Brass / Latón / Messing / Ottone
H31	4	Preformado / Prefomed/ Préformé / Vorgeformt / Preformato	Metal / Metal / Metal / Metall / Metallo
H32	1	Preformado / Prefomed/ Préformé / Vorgeformt / Preformato	Metal / Metal / Metal / Metall / Metallo
H33	1	Preformado / Prefomed/ Préformé / Vorgeformt / Preformato	Metal / Metal / Metal / Metall / Metallo
H34	1	Preformado / Prefomed/ Préformé / Vorgeformt / Preformato	Metal / Metal / Metal / Metall / Metallo
H35	1	Preformado / Prefomed/ Préformé / Vorgeformt / Preformato	Latón / Brass / Latón / Messing / Ottone
i1	2	4x4x100	Tilo / Lime wood / Tilleul / Linde / Tiglio
i2	4	3x3x30	Tilo / Lime wood / Tilleul / Linde / Tiglio
i3	2	2x3x60	Tilo / Lime wood / Tilleul / Linde / Tiglio
i4	4	2x3x20	Tilo / Lime wood / Tilleul / Linde / Tiglio
i5	4	Preformado / Prefomed/ Préformé / Vorgeformt / Preformato	Metal / Metal / Metal / Metall / Metallo
i6	4	Preformado / Prefomed/ Préformé / Vorgeformt / Preformato	Metal / Metal / Metal / Metall / Metallo
i7	2	Preformado / Prefomed/ Préformé / Vorgeformt / Preformato	Metal / Metal / Metal / Metall / Metallo
i8	2	Preformado / Prefomed/ Préformé / Vorgeformt / Preformato	Metal / Metal / Metal / Metall / Metallo
i9	6	ø8	Latón / Brass / Latón / Messing / Ottone
i10	6	ø0,15x100	Hilo crudo / Raw thread / Fil brut / Rohes Baumwollfaden / Filo crudo
i11	2	ø1,5x30	Latón / Brass / Latón / Messing / Ottone
i12	2	ø1x30	Latón / Brass / Latón / Messing / Ottone
i13	1	ø0,15x150	Hilo crudo / Raw thread / Fil brut / Rohes Baumwollfaden / Filo crudo
i14-i15	2	Preformado / Prefomed/ Préformé / Vorgeformt / Preformato	Madera / Wood / Bois / Holz / Legno
i16	6	1x4x17	Tilo / Lime wood / Tilleul / Linde / Tiglio
i17	2	ø1x15	Latón / Brass / Latón / Messing / Ottone
i18	2	Preformado / Prefomed/ Préformé / Vorgeformt / Preformato	Metal / Metal / Metal / Metall / Metallo
i19	16	1x3x20	Tilo / Lime wood / Tilleul / Linde / Tiglio
i20	4	ø0,15x150	Hilo crudo / Raw thread / Fil brut / Rohes Baumwollfaden / Filo crudo
X-Y	2	Precortado / Precut / Prédécoupé / Vorgeschnitten / Pretagliato	Tablero / Plywood / Planche / Sperrholz / Tavola
Z	2	Preformado / Prefomed/ Préformé / Vorgeformt / Preformato	Tablero / Plywood / Planche / Sperrholz / Tavola

Lista de piezas / Parts List / Liste des pièces / Teilleiste / Elenco delle parti

<i>Nº/No./ N° / Nr. / No</i>	<i>Descripción / Description /Description / Beschreibung / Descrizione</i>	<i>Cantidad / Quantity / Quantité / Menge/ Quantità</i>	<i>Medidas / Measurements / Dimensions /Maße / Misure</i>	<i>Material / Material / Matériau / Material / Materiale</i>
A		700	10	Metal / Metal / Metal / Metall / Metallo
B		90	15	Latón / Brass / Latón / Messing / Ottone
C		109	ø0,15x100	Hilo crudo / Raw thread / Fil brut / Rohes Baumwollfaden / Filo crudo
D		96	4	Composite / Composite / Composite / Composite / Composite
E		27	4	Composite / Composite / Composite / Composite / Composite
F		90	ø4	Composite / Composite / Composite / Composite / Composite
G		120	ø5	Composite / Composite / Composite / Composite / Composite
H		16	ø3	Latón / Brass / Latón / Messing / Ottone
J		95	10	Composite / Composite / Composite / Composite / Composite

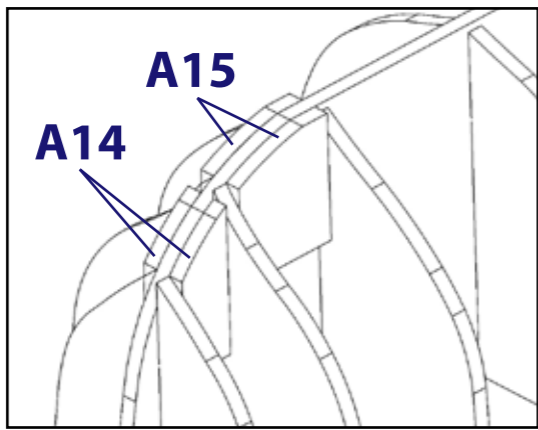

Accede a vídeos tutoriales fotografiando los códigos QR.
Access tutorial videos photographing QR codes.
Accédez aux didacticiels vidéo photographiant les codes QR.
Greifen Sie auf Video-Tutorials zu, die QR-Code fotografieren.
Accedi ai video tutorial fotografando i codici QR.
Доступ к видеоурокам фотографирования QR-кодов.

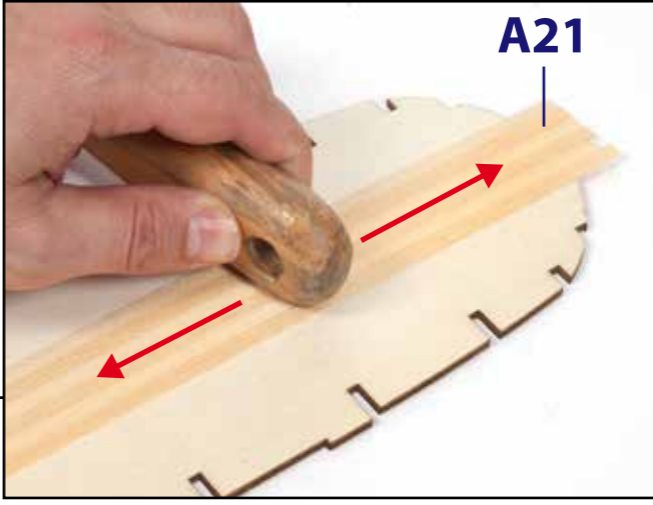
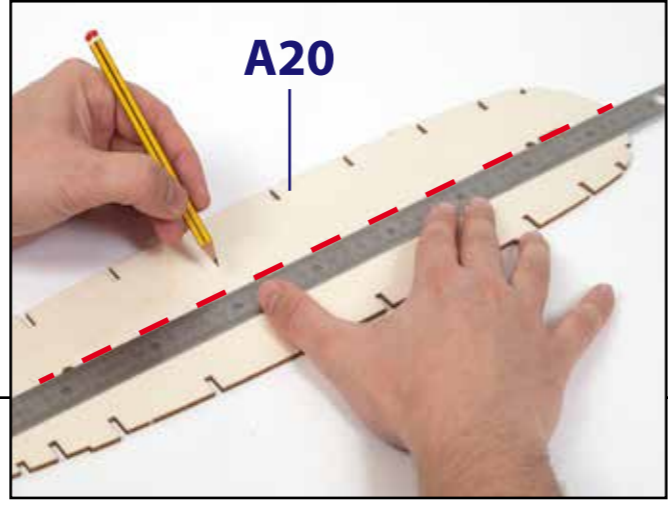
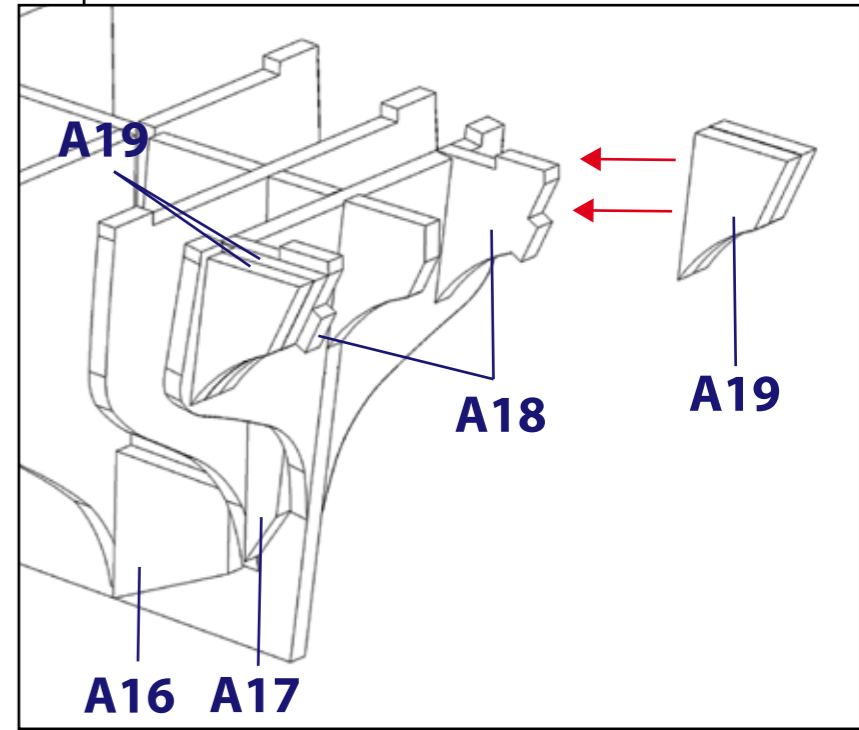
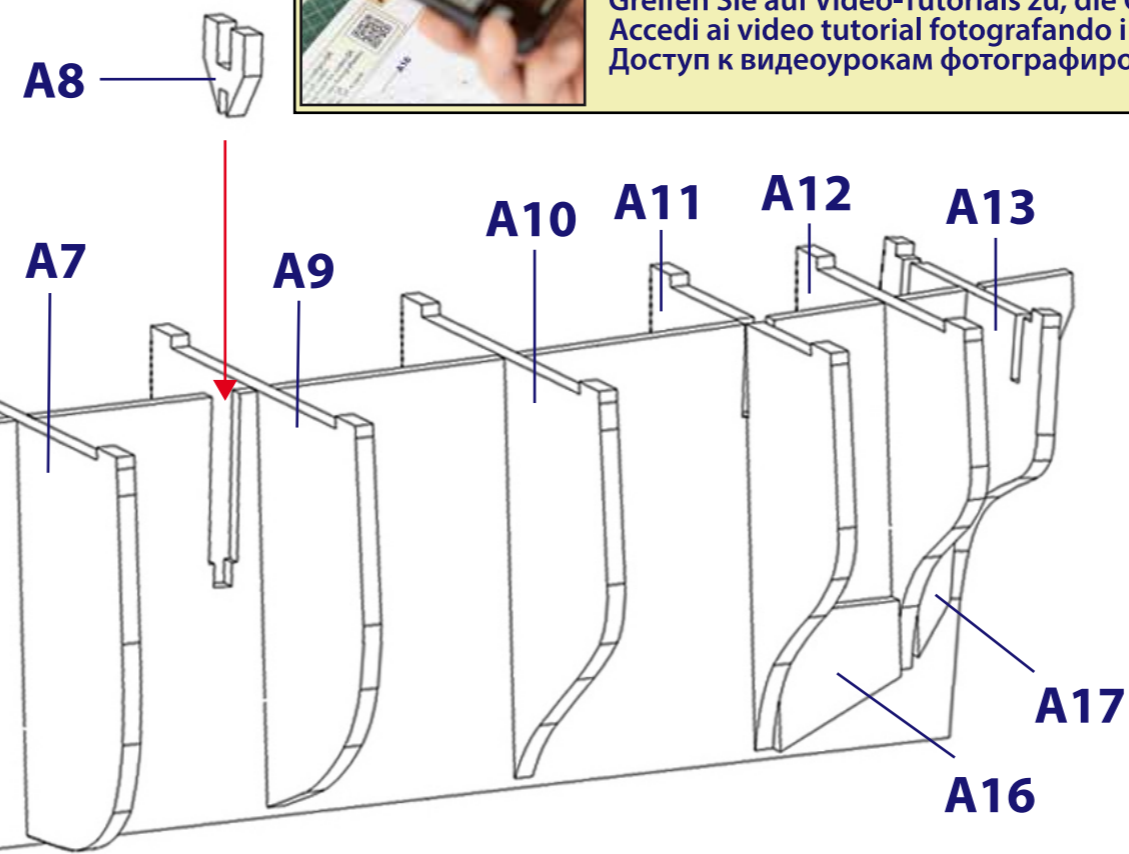
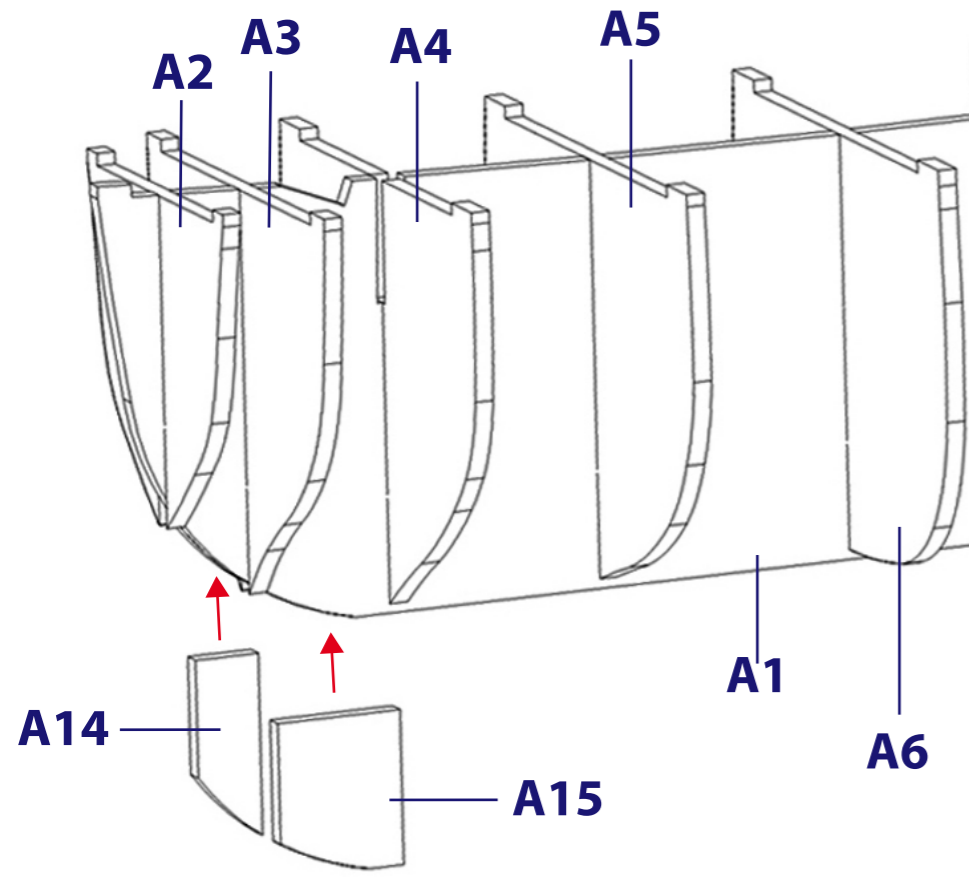

Model based on the plans of Matthew Betts

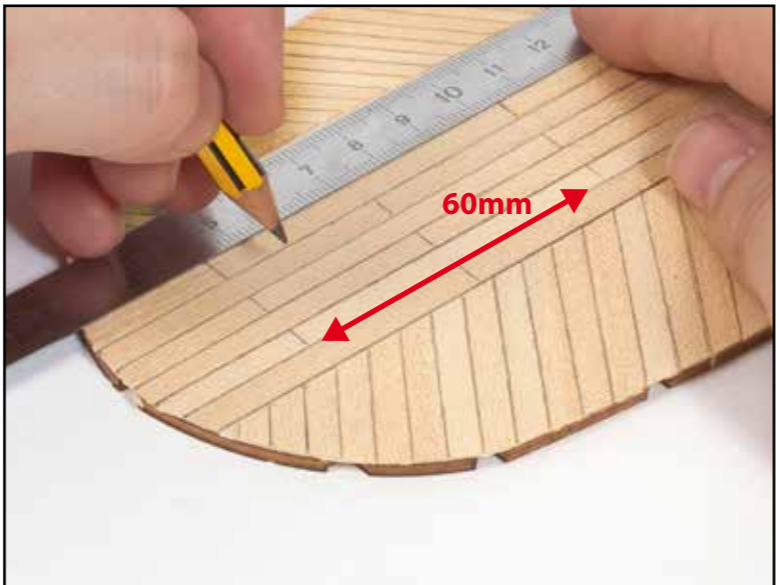
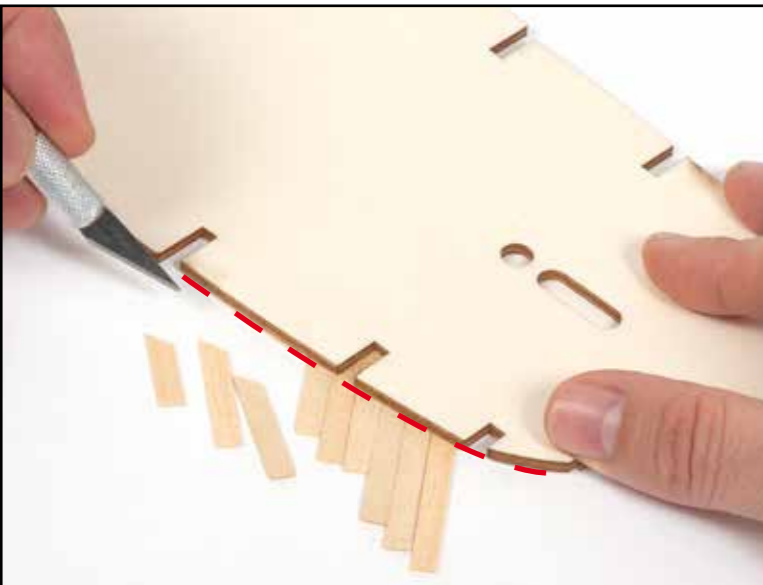

B

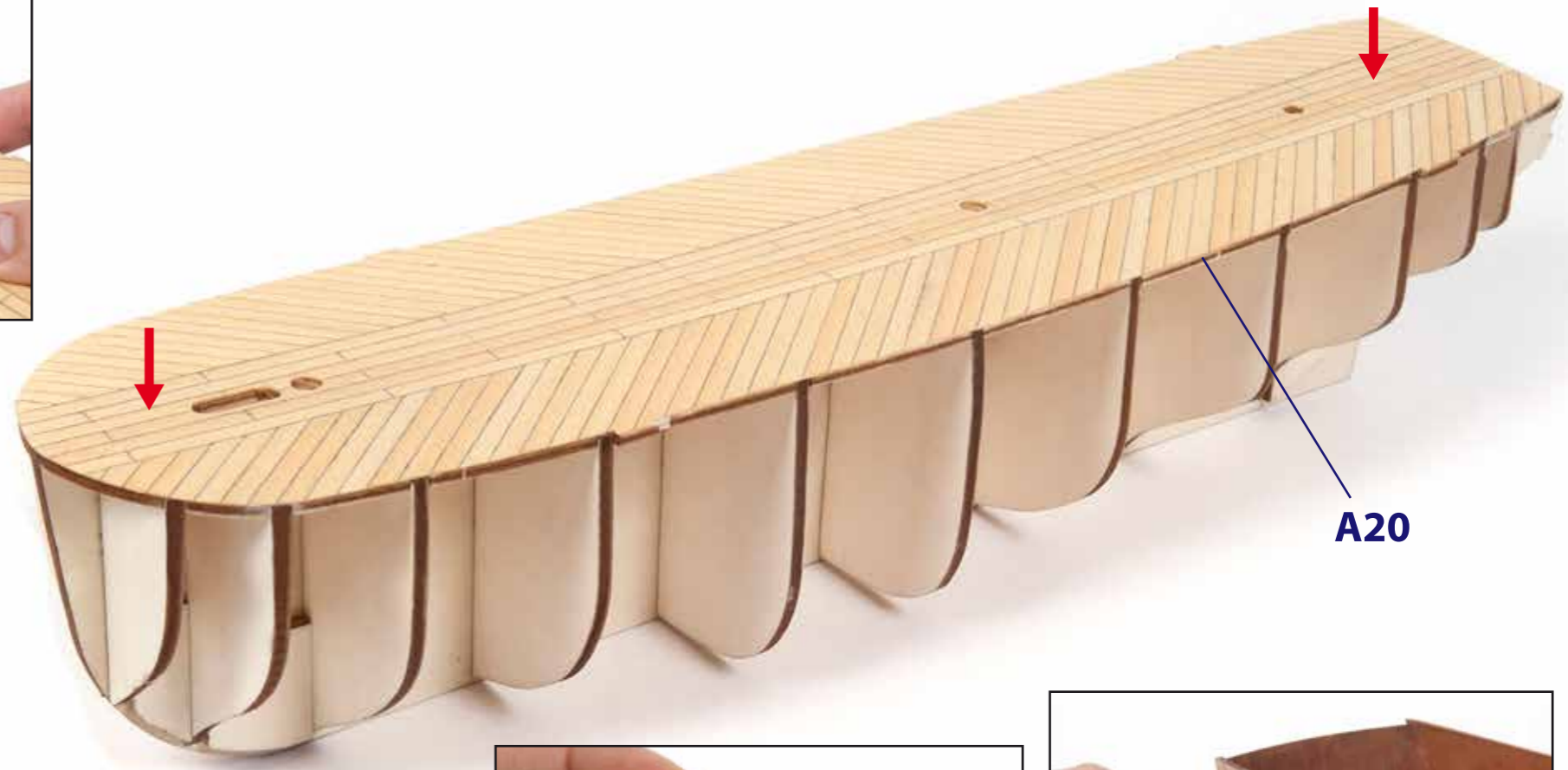
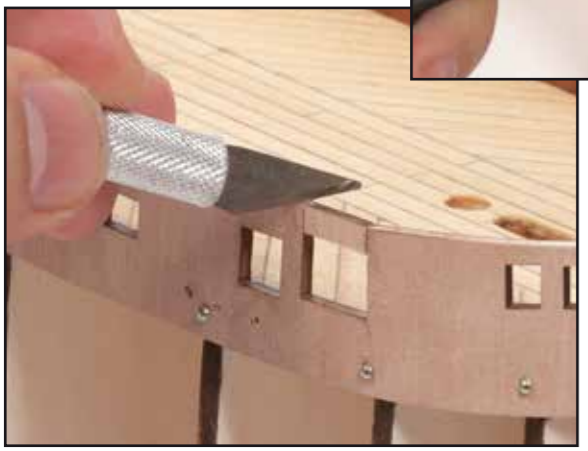
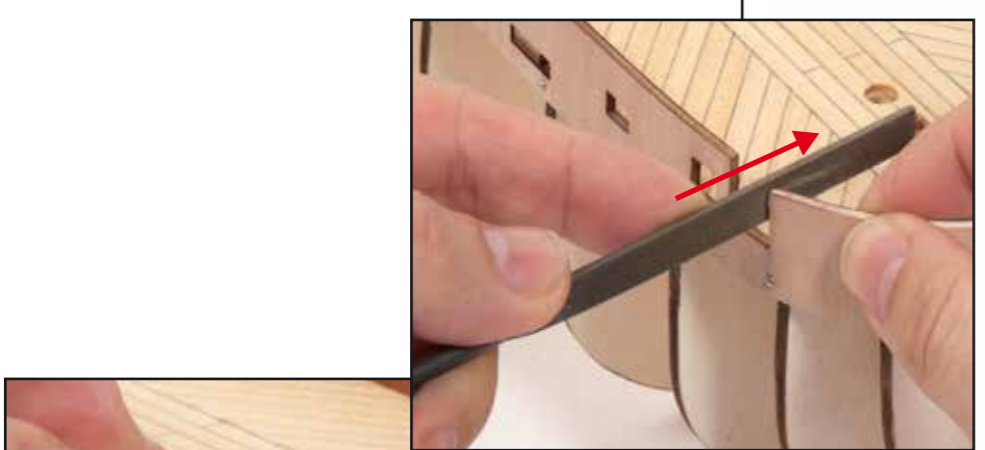
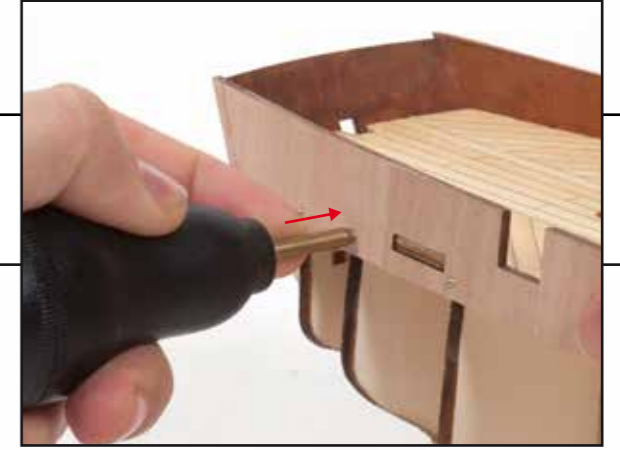
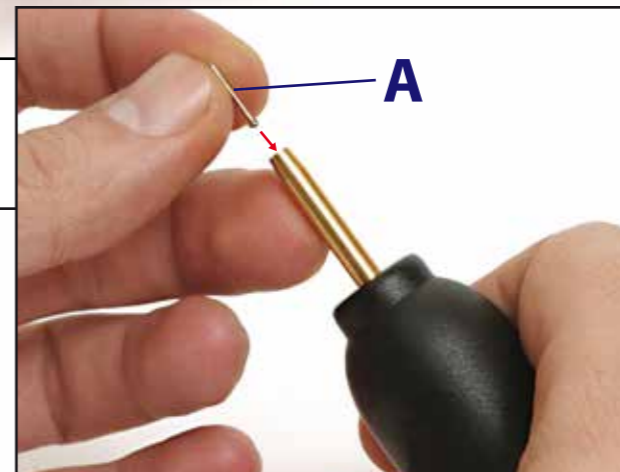
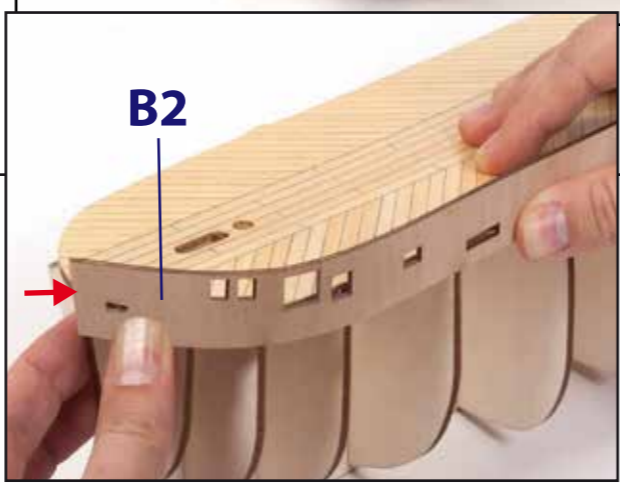
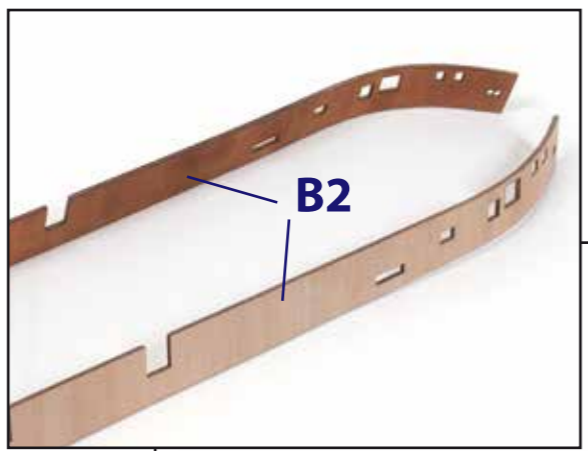
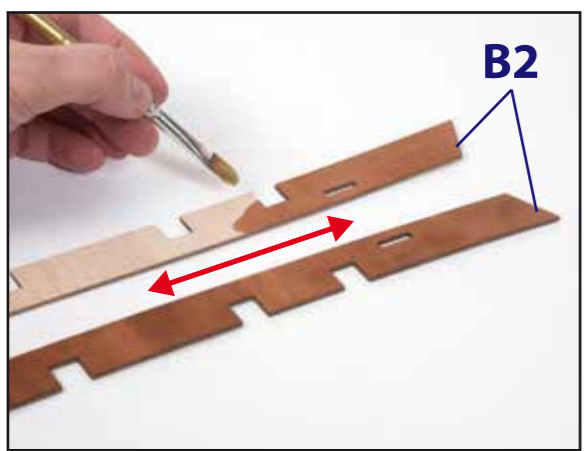
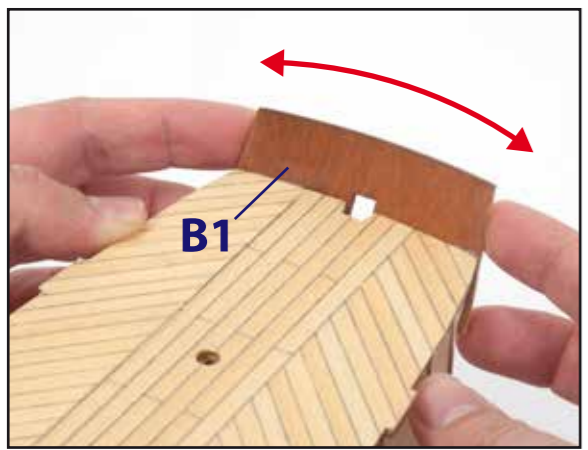
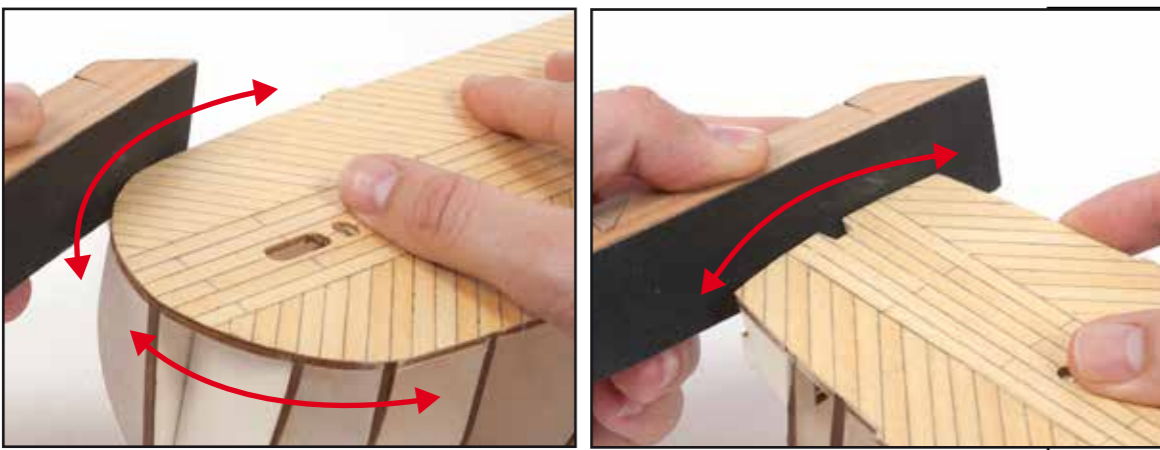

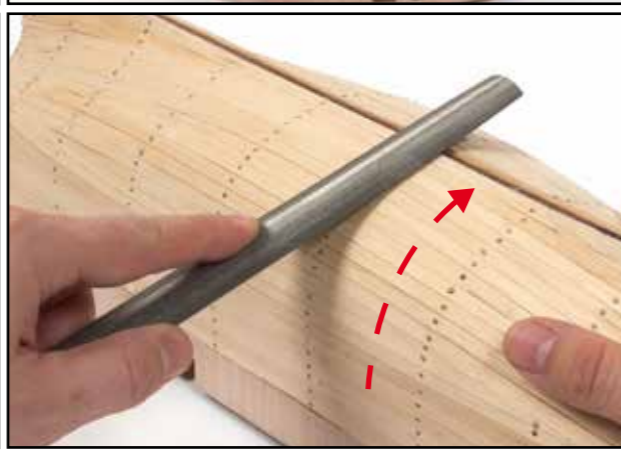
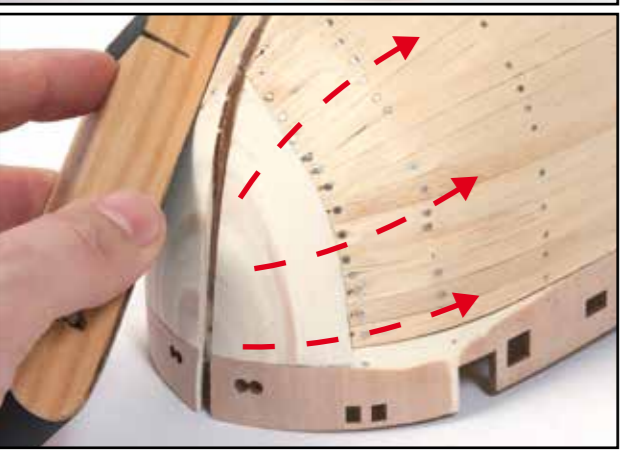
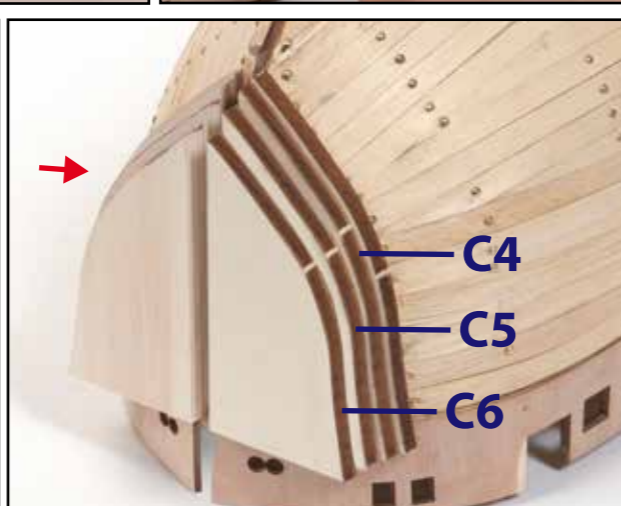
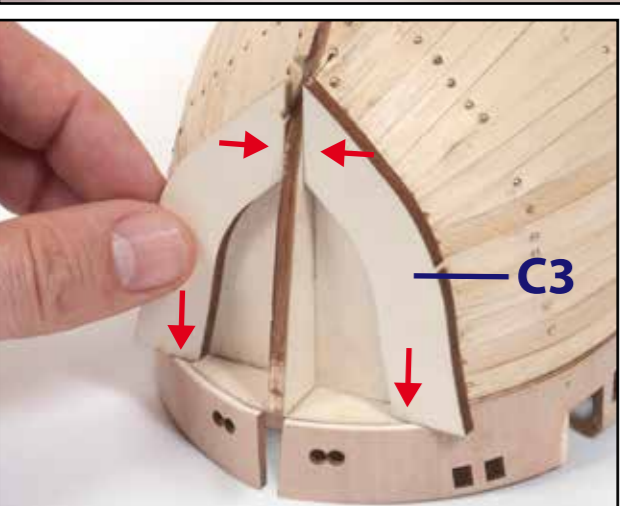
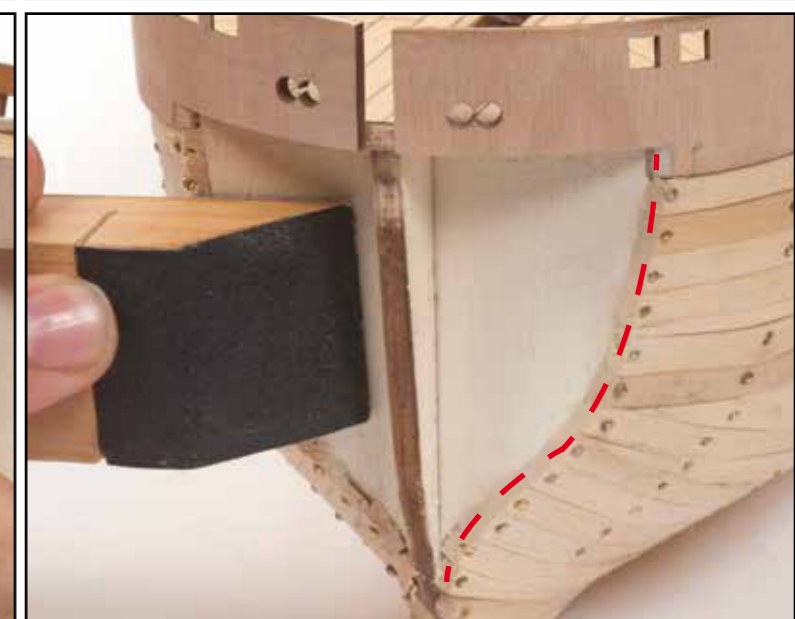
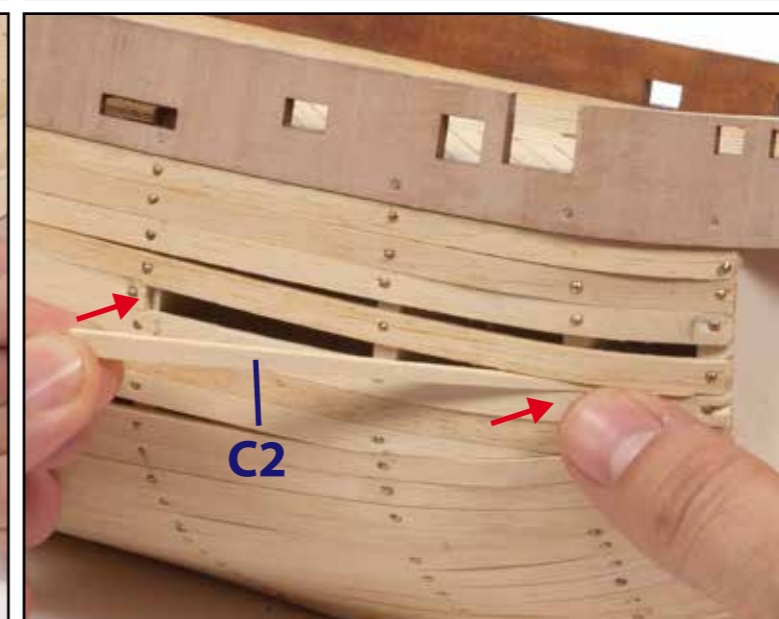
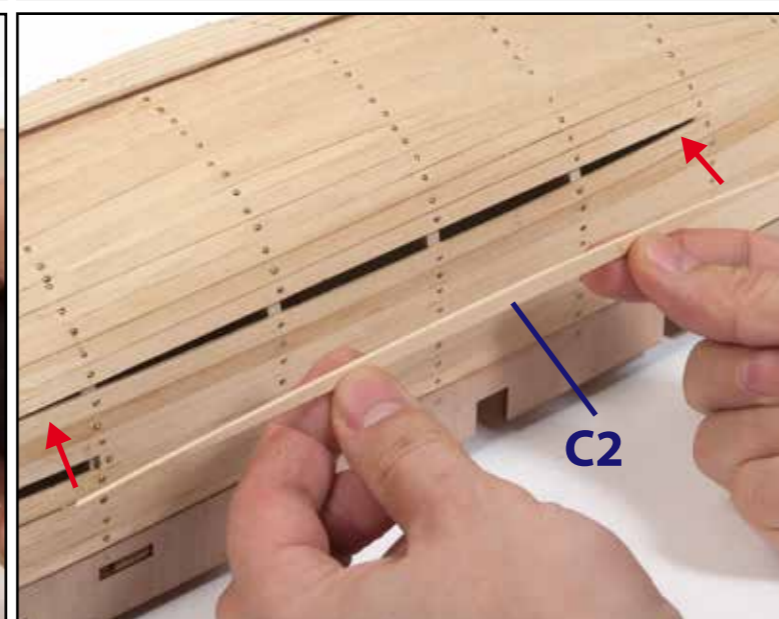
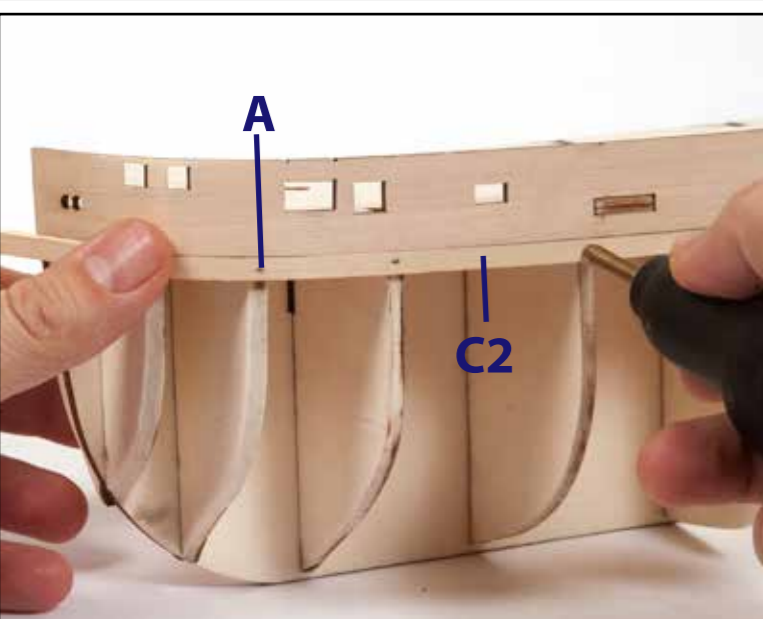
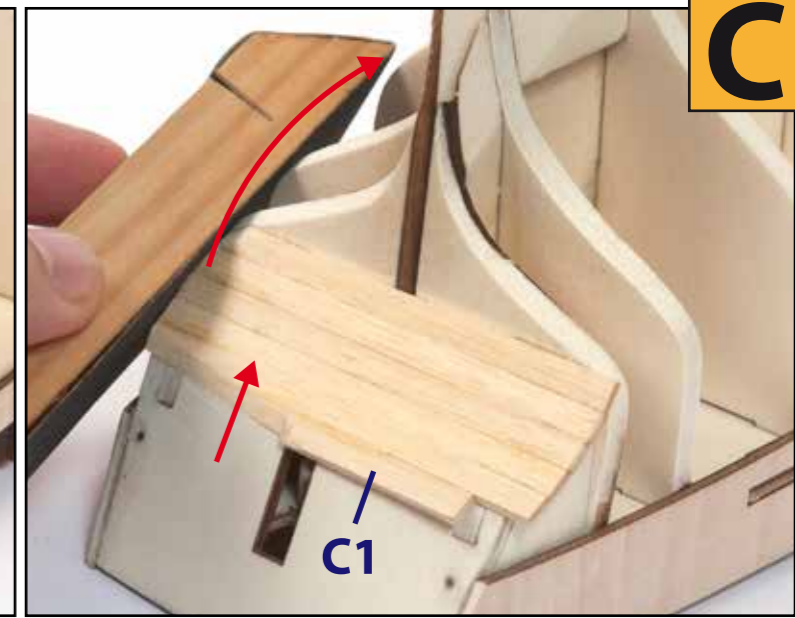
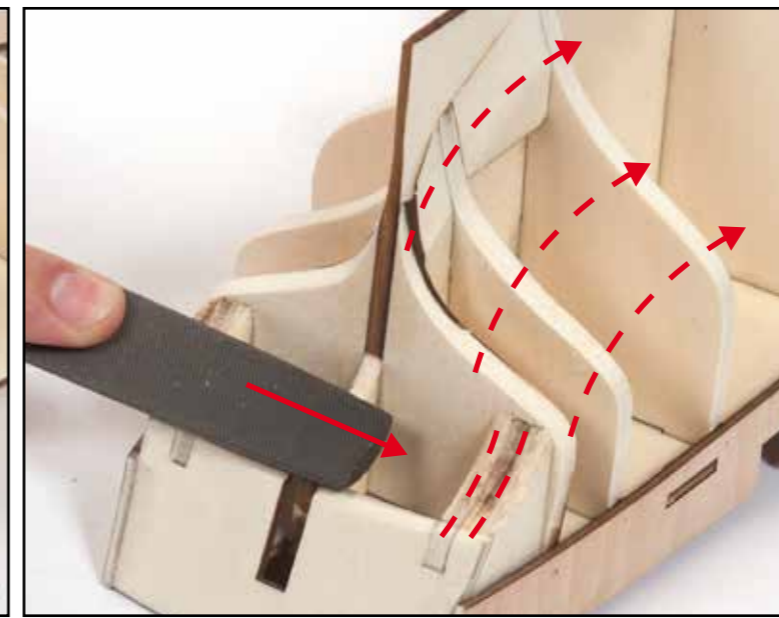
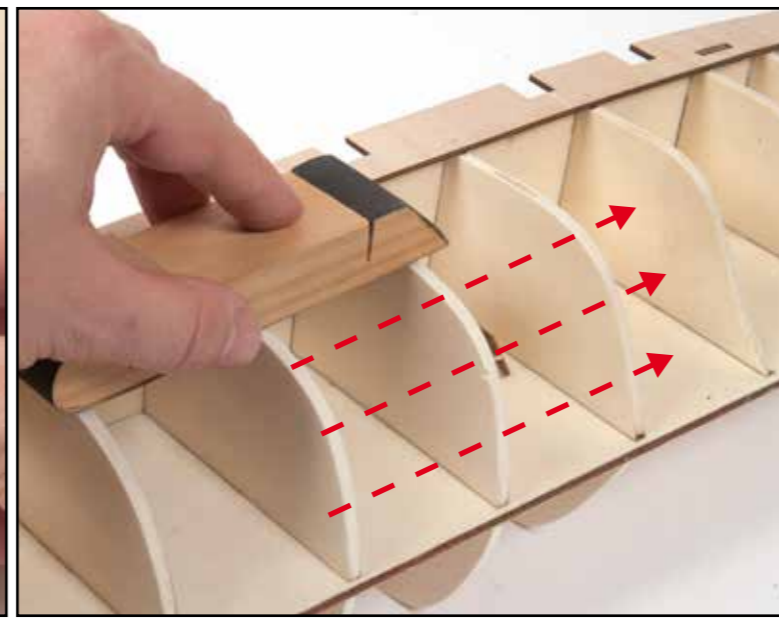
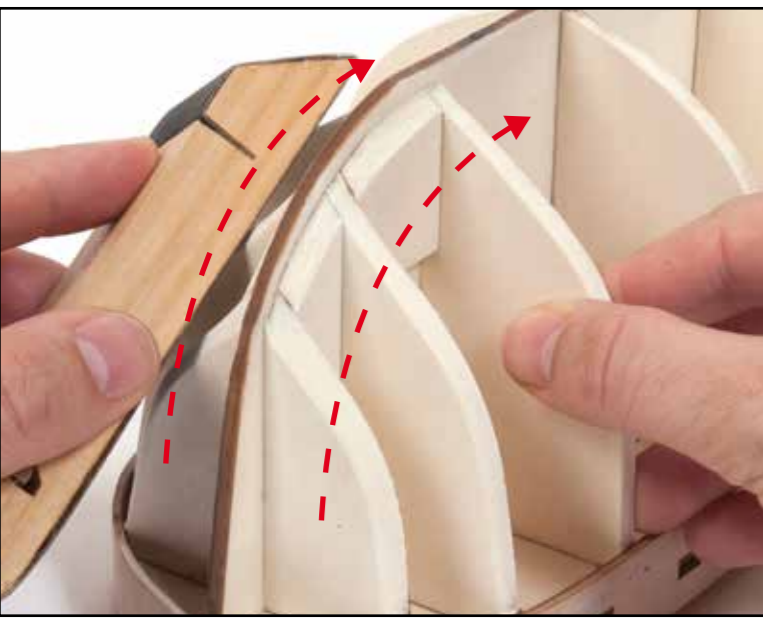
C

D

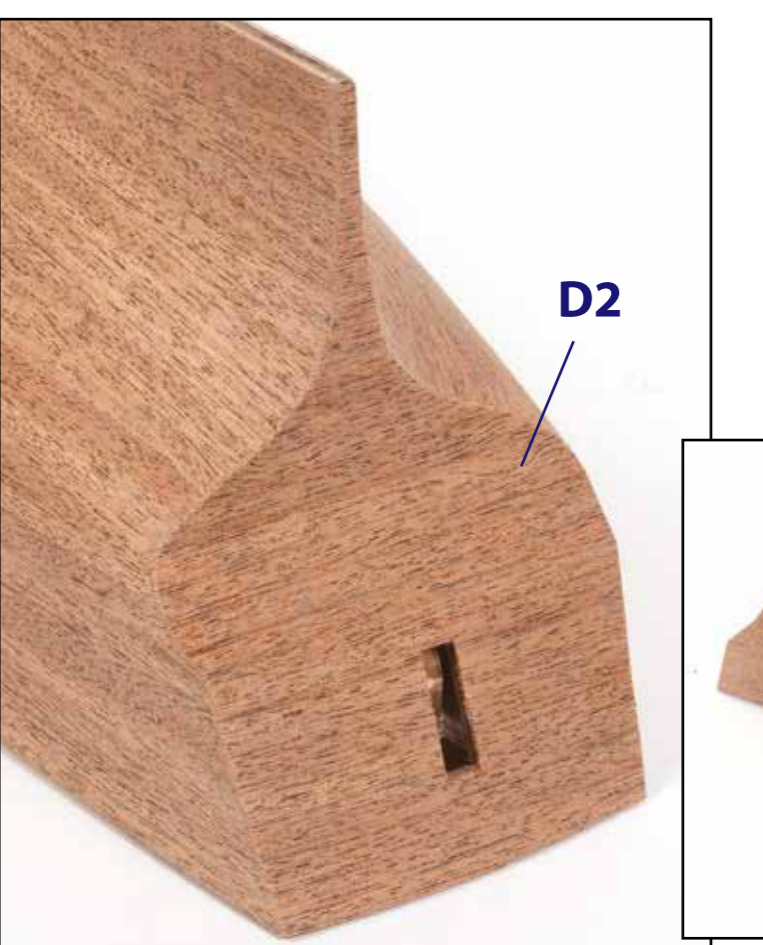
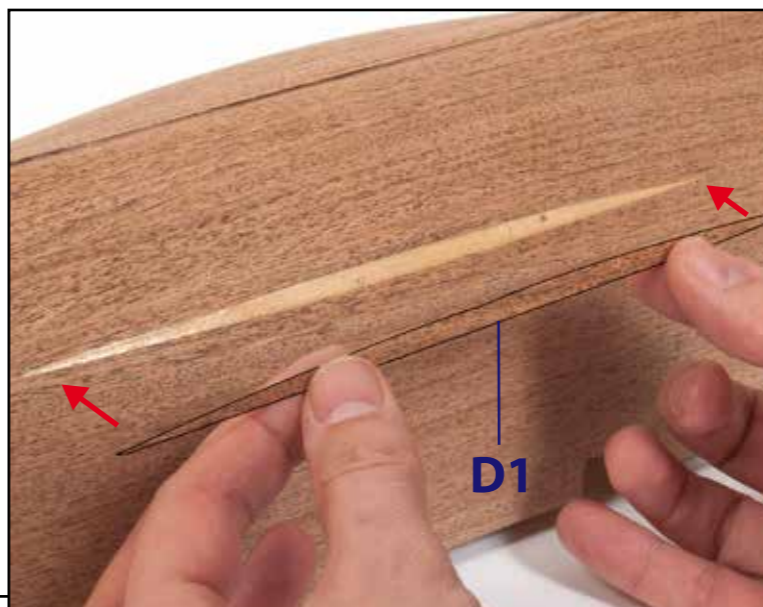
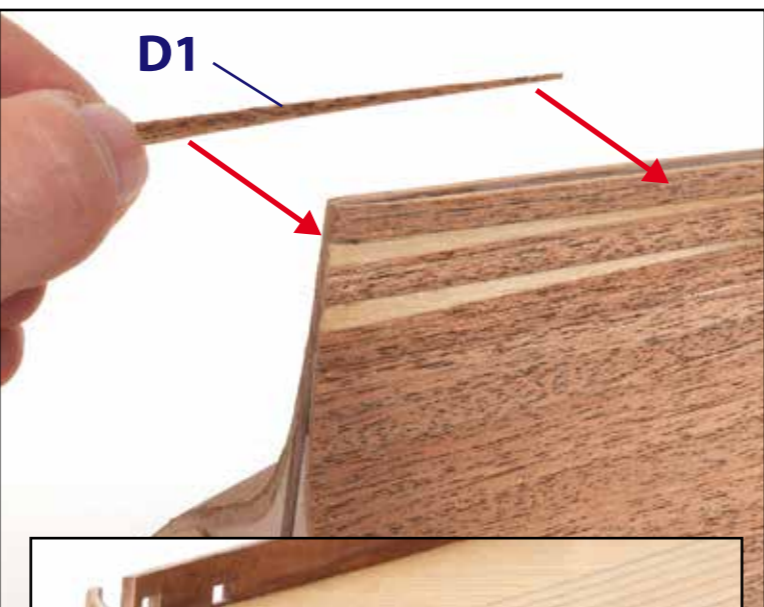
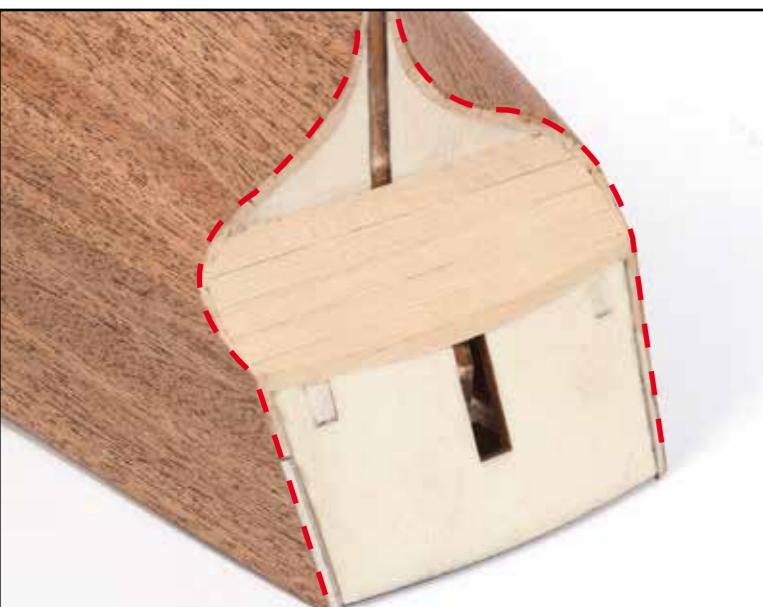
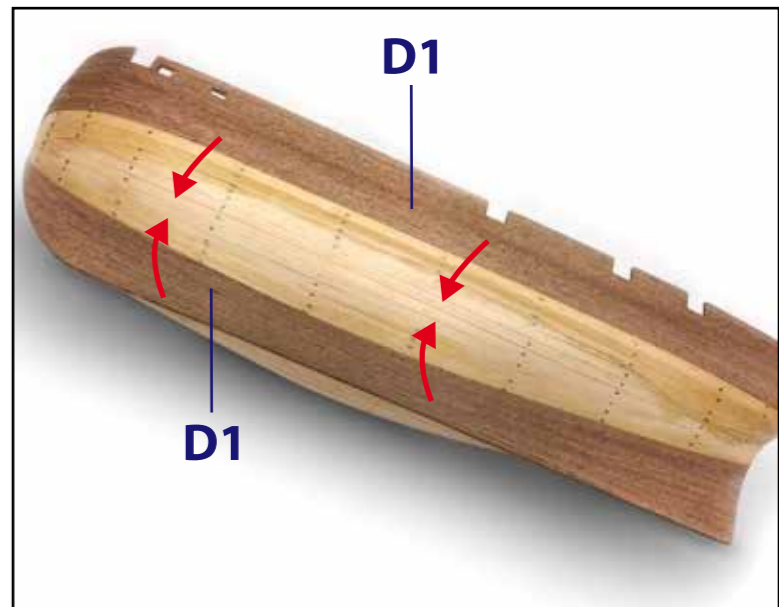
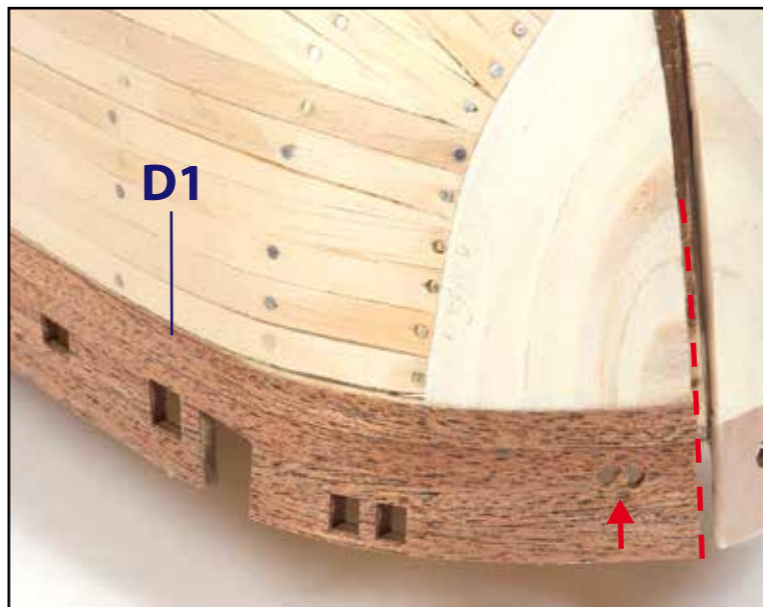
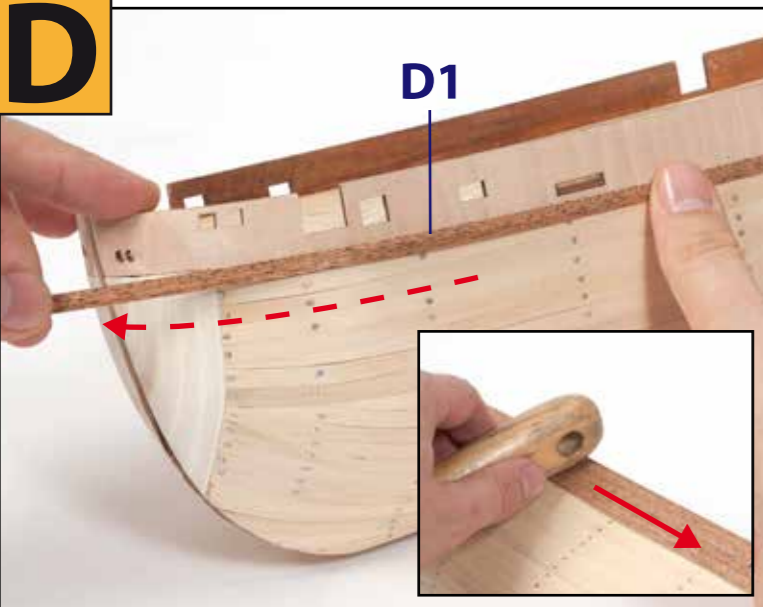

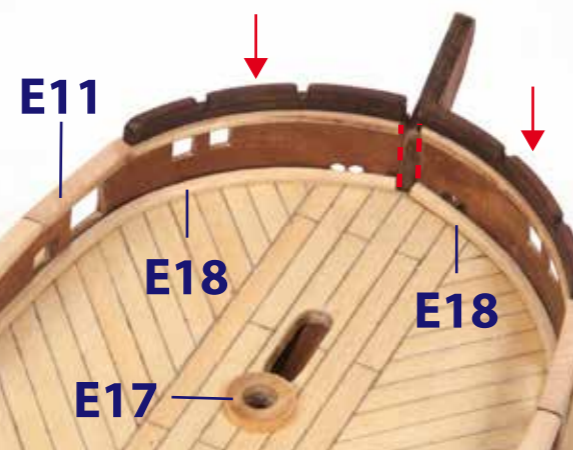
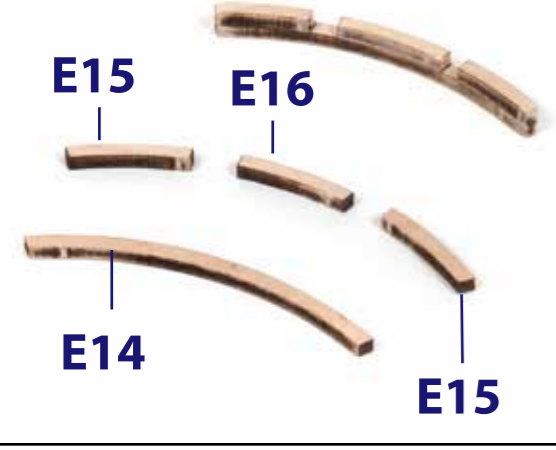
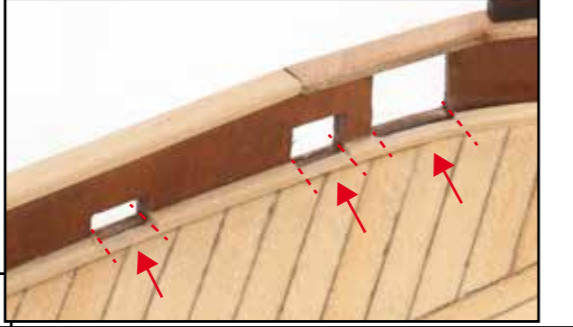
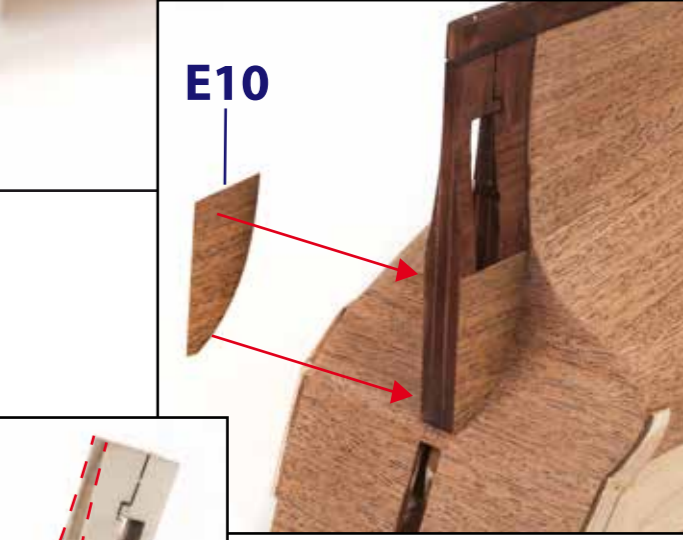
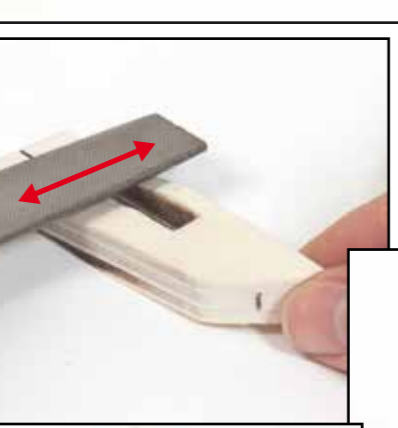
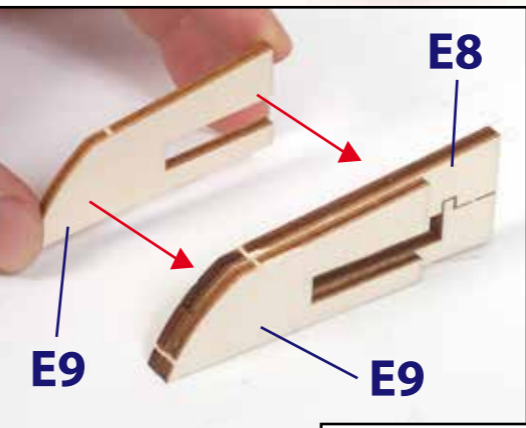
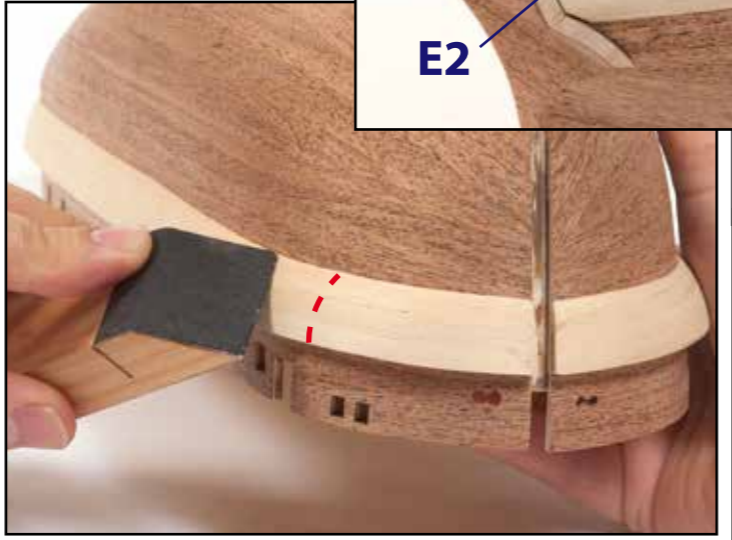
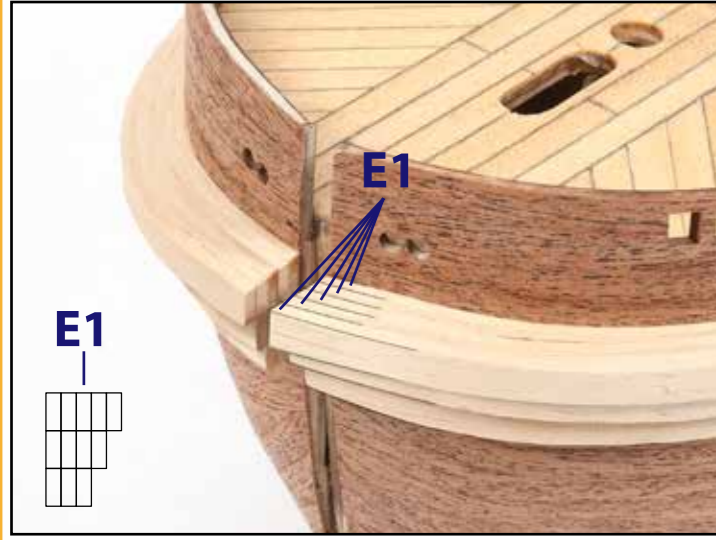
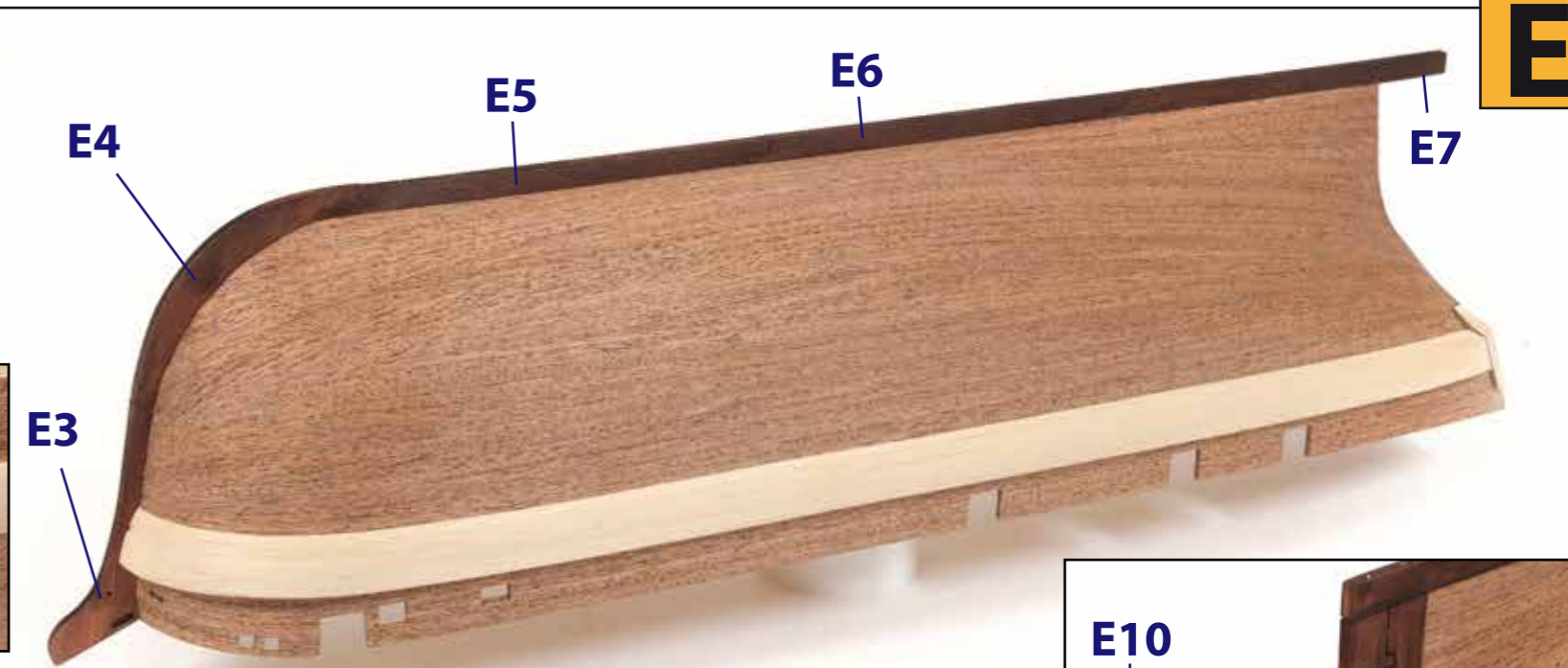
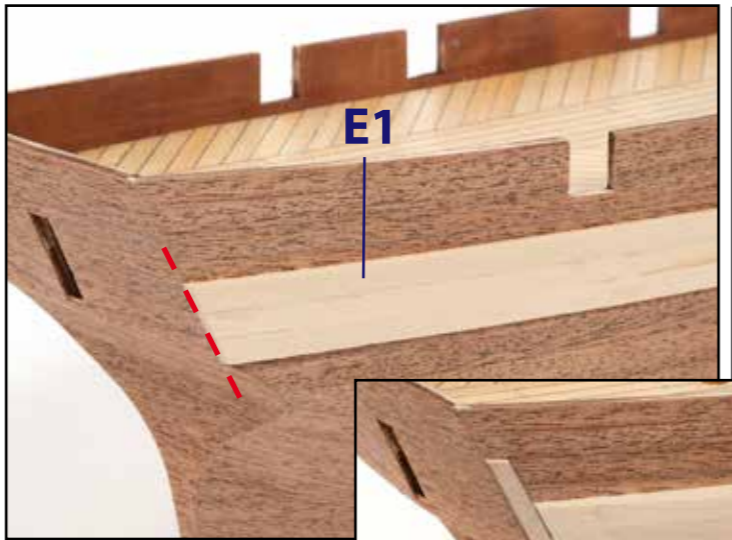
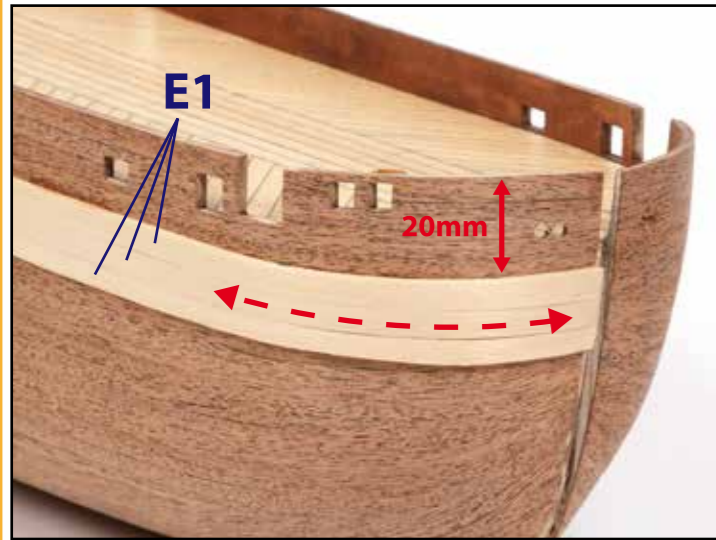

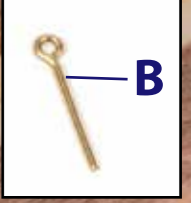
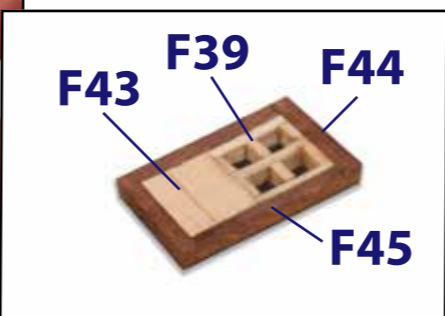
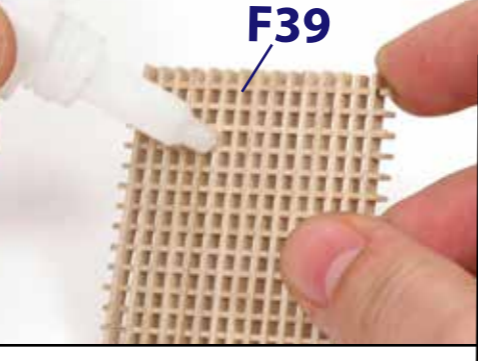
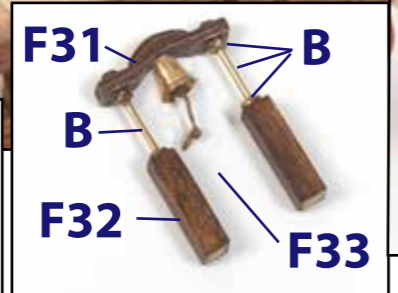
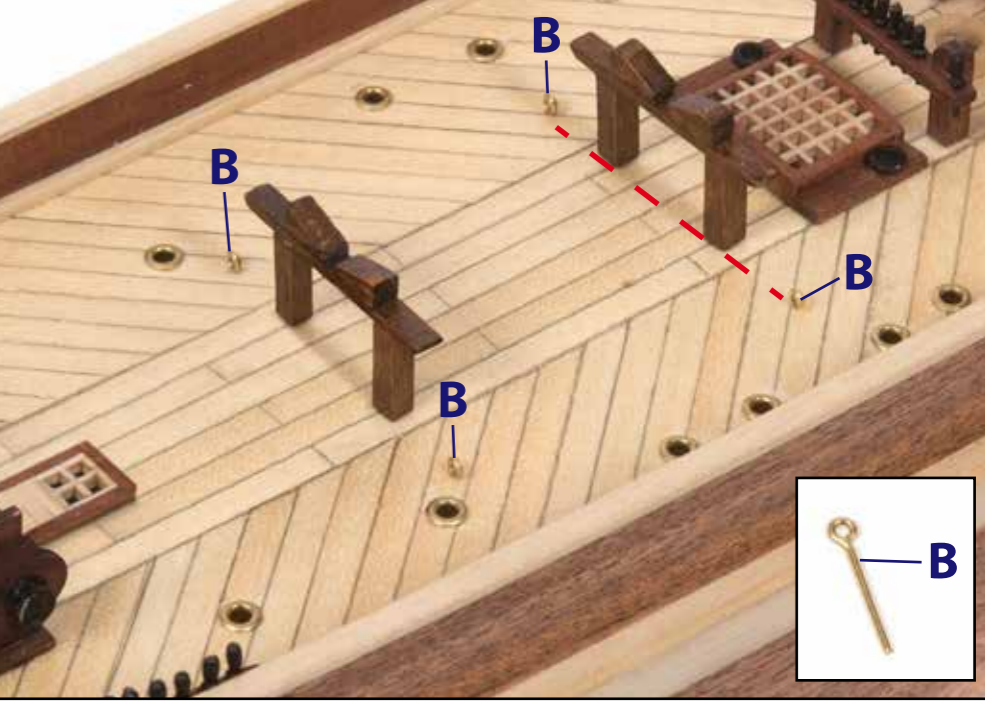
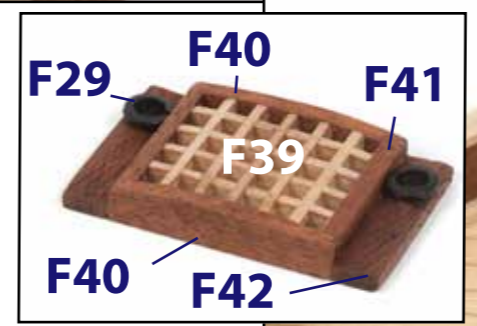
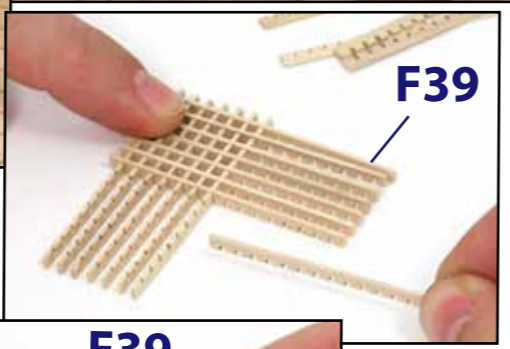
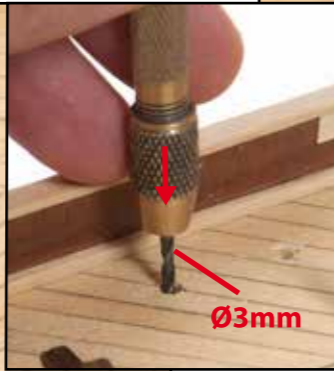
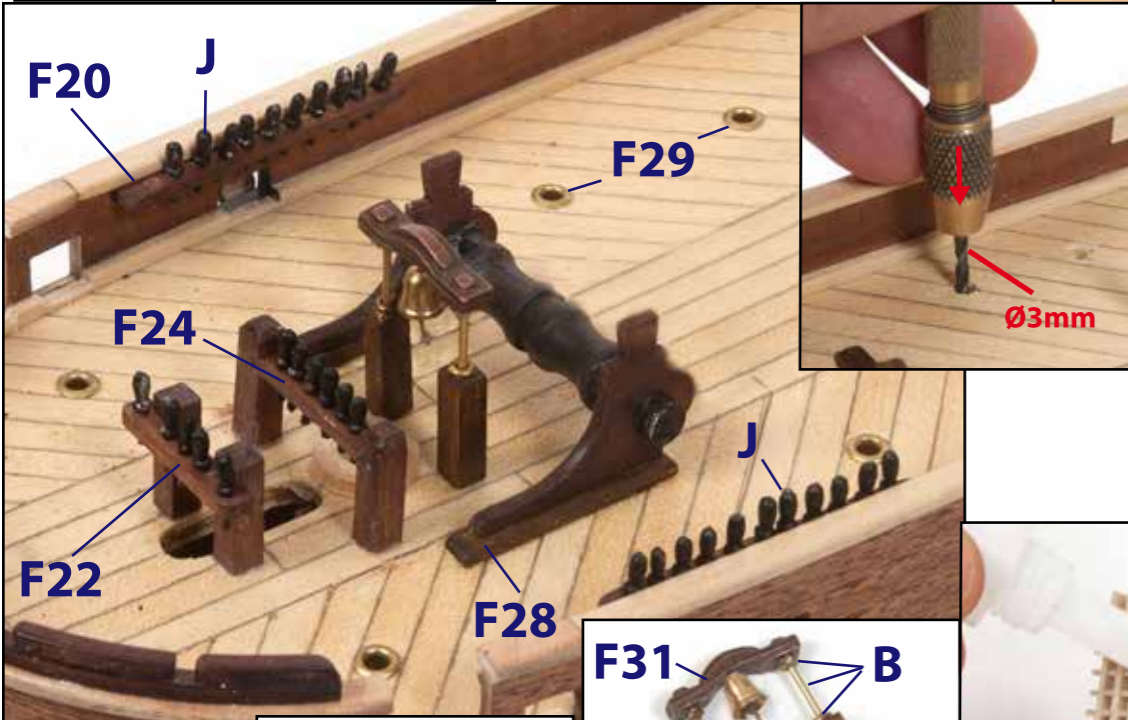
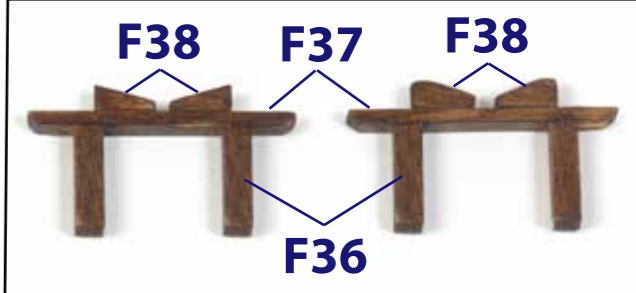
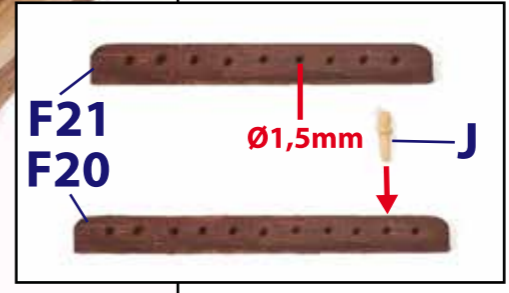
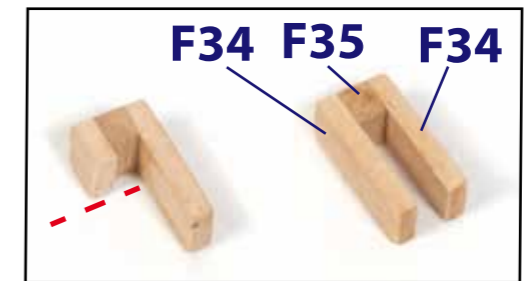
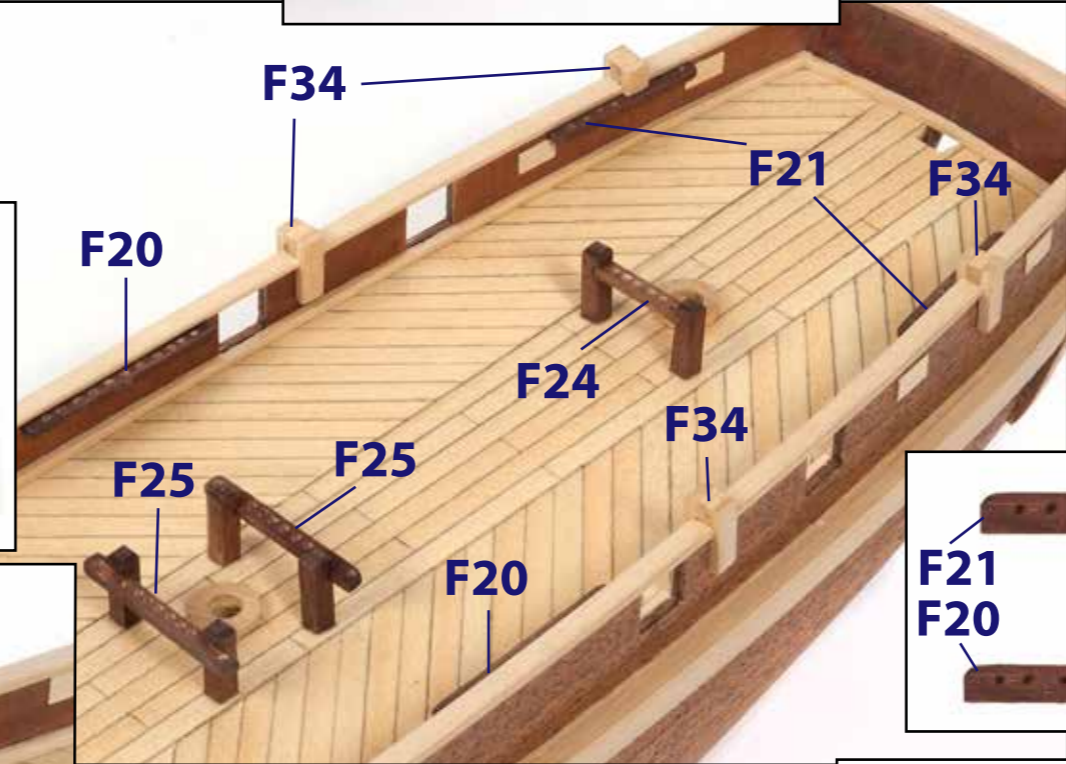
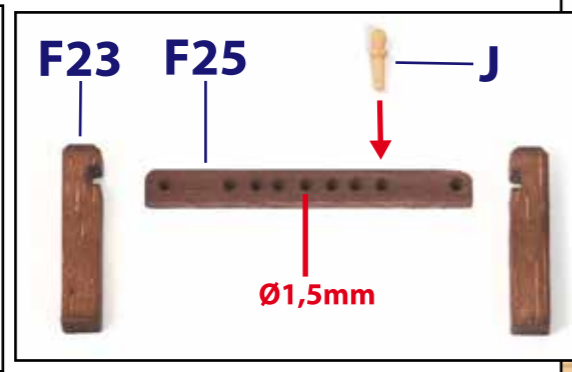
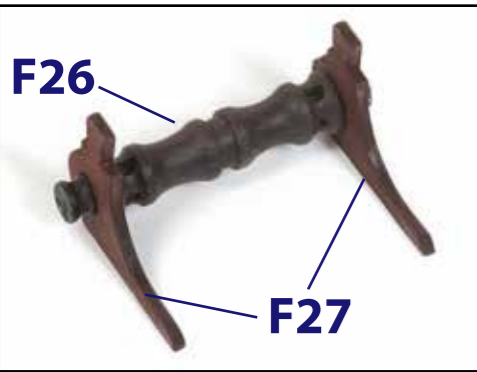
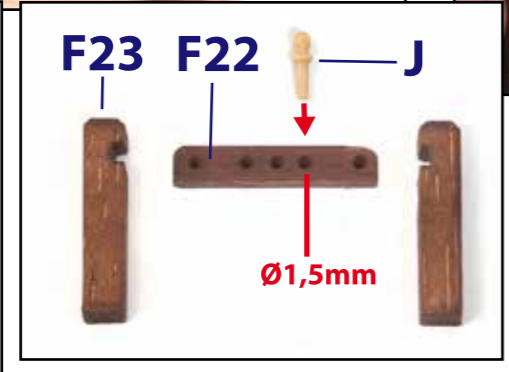
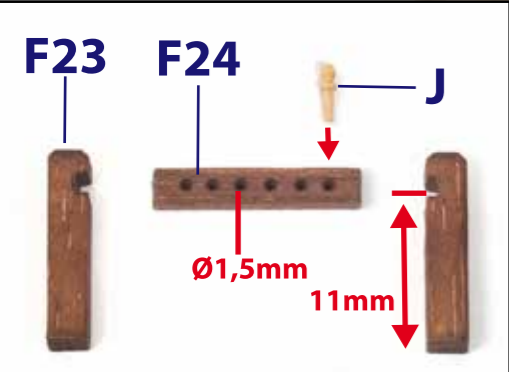
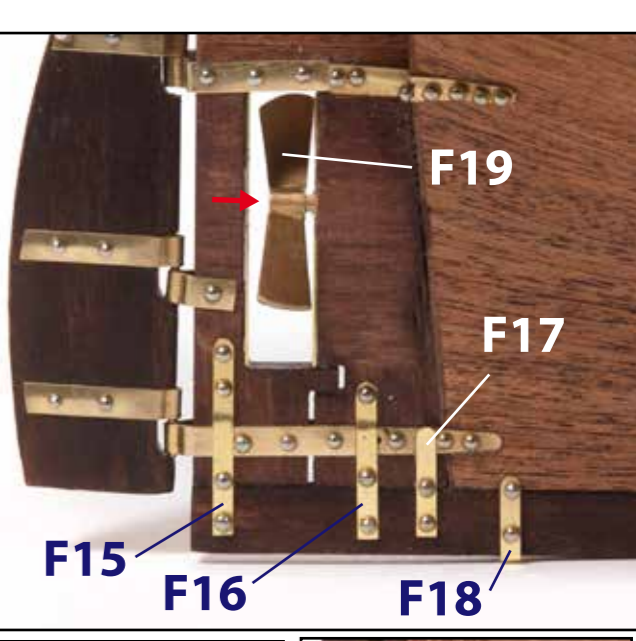
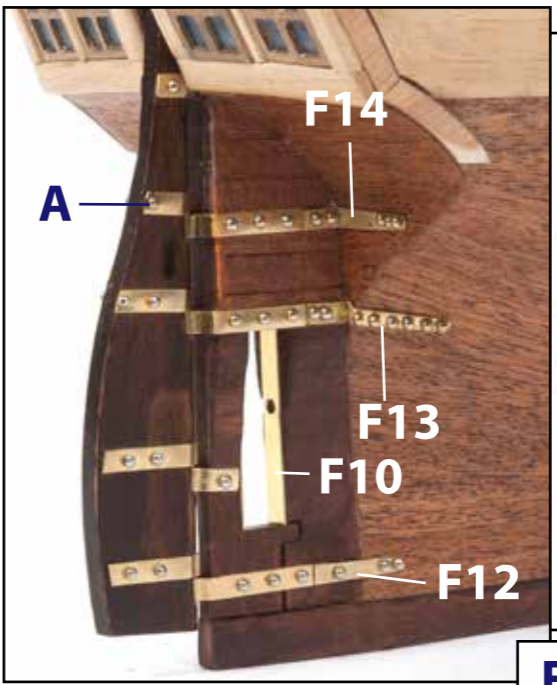
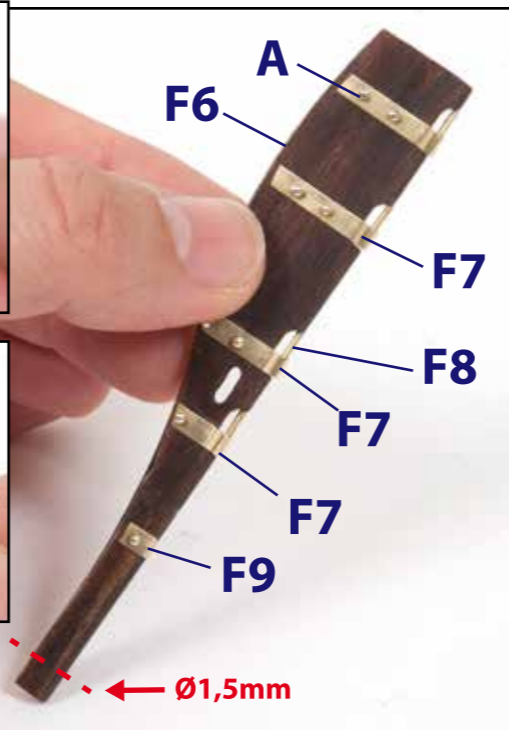
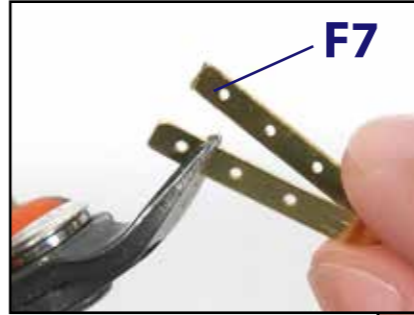
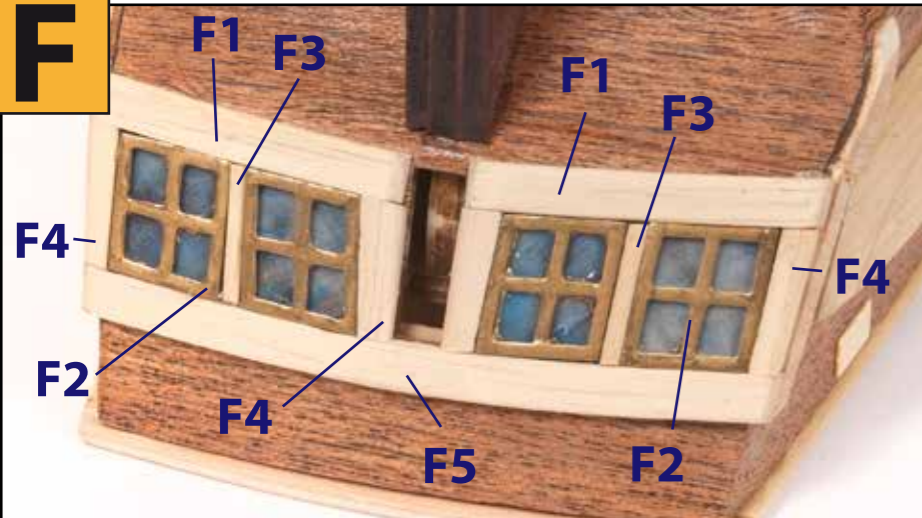

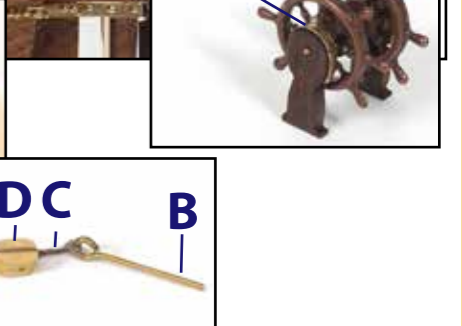
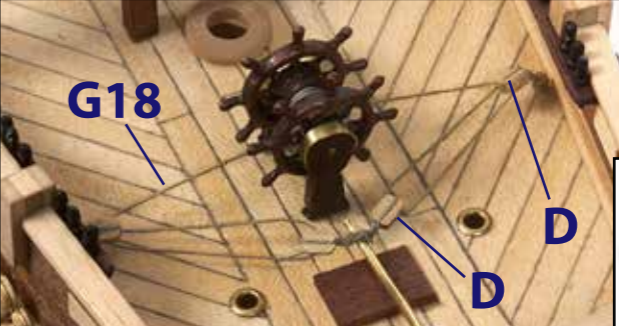
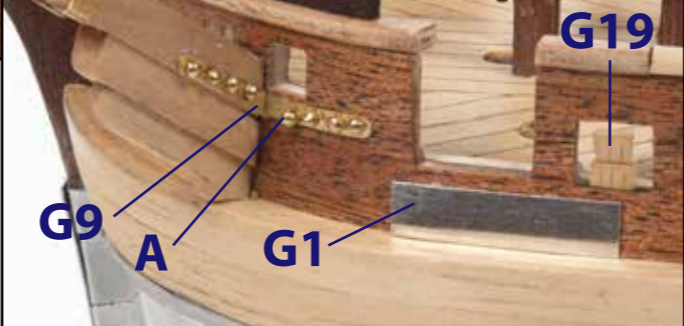
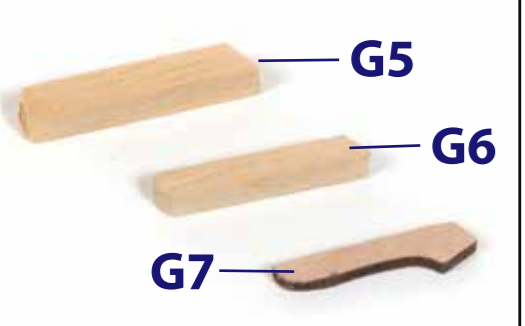
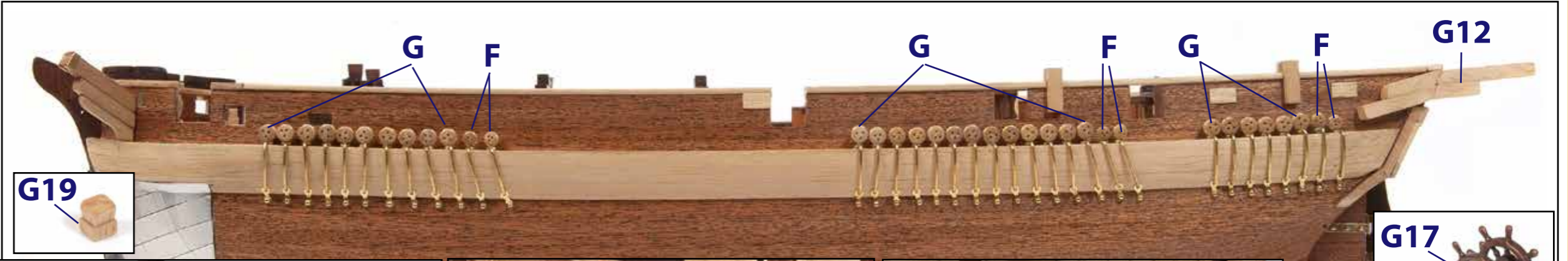
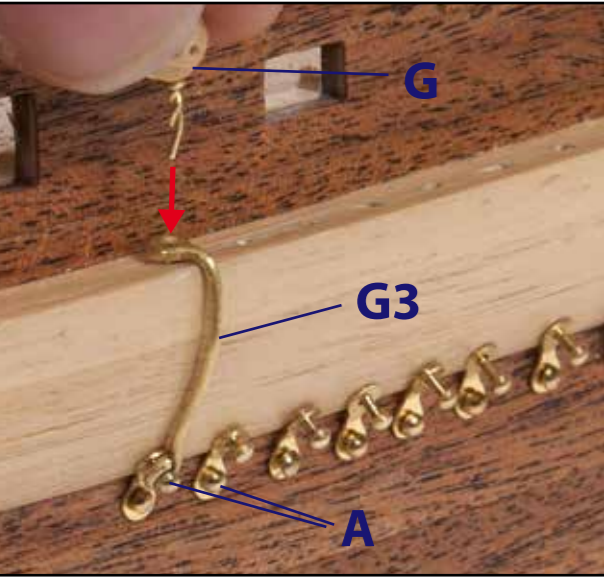
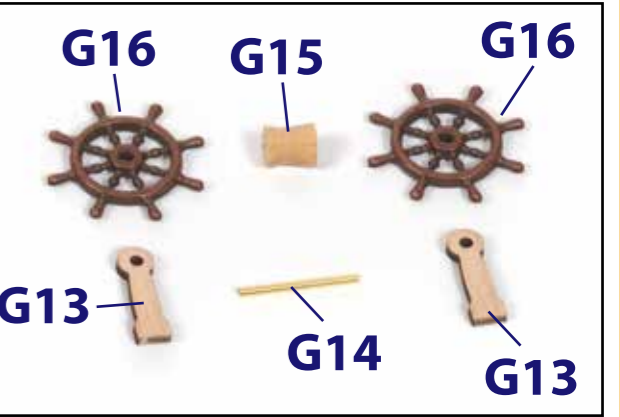
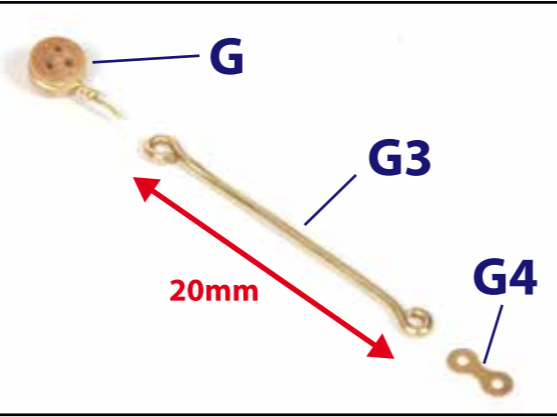
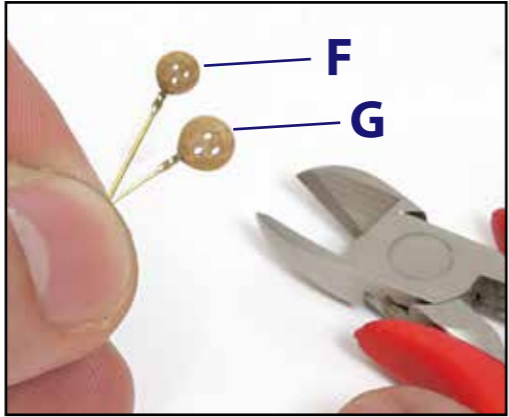
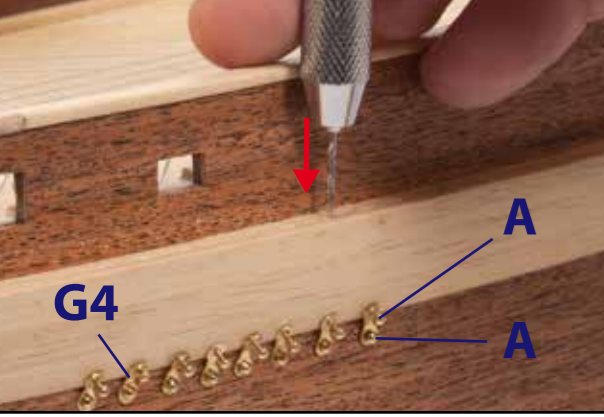
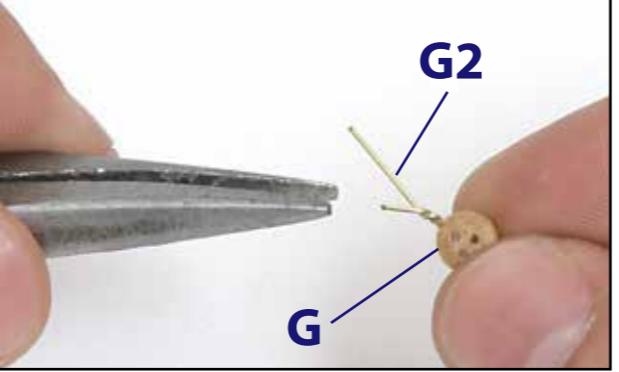
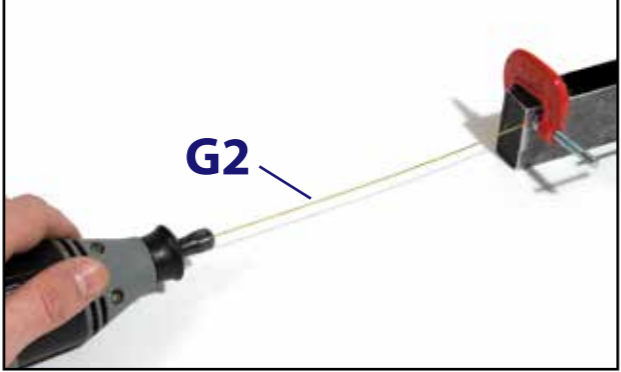
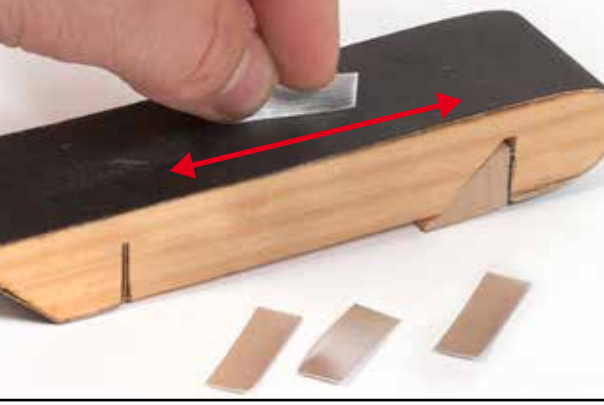
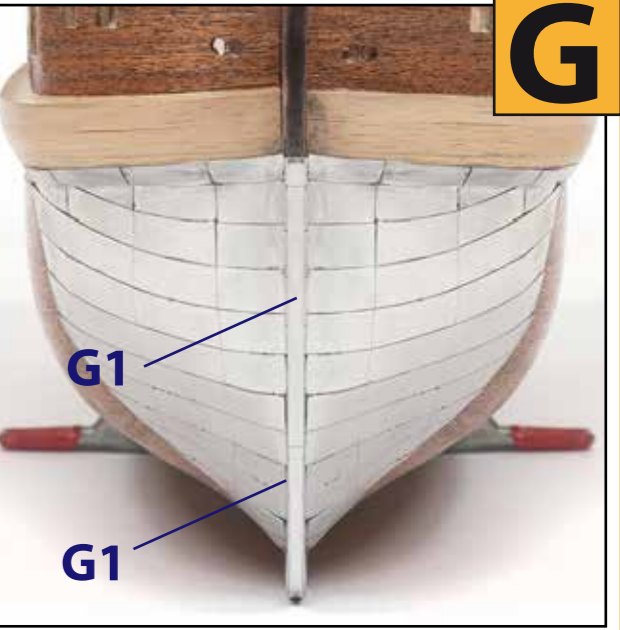
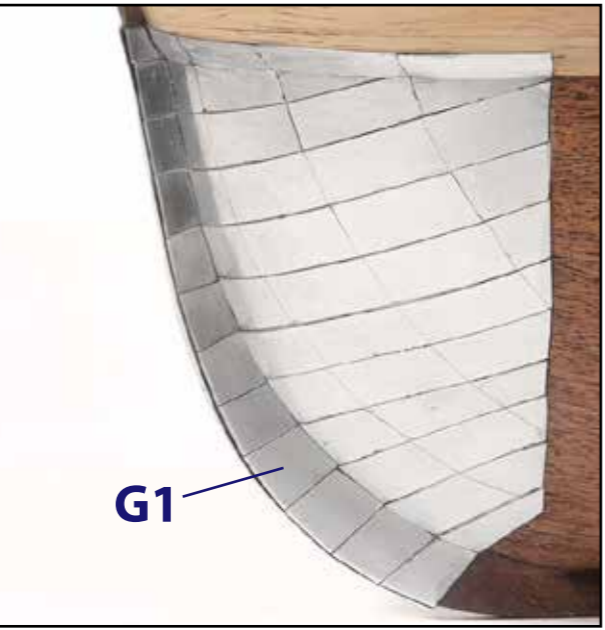
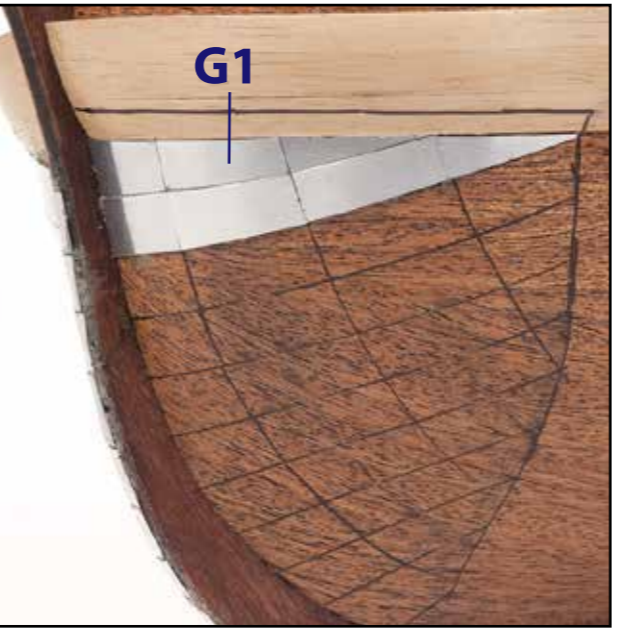
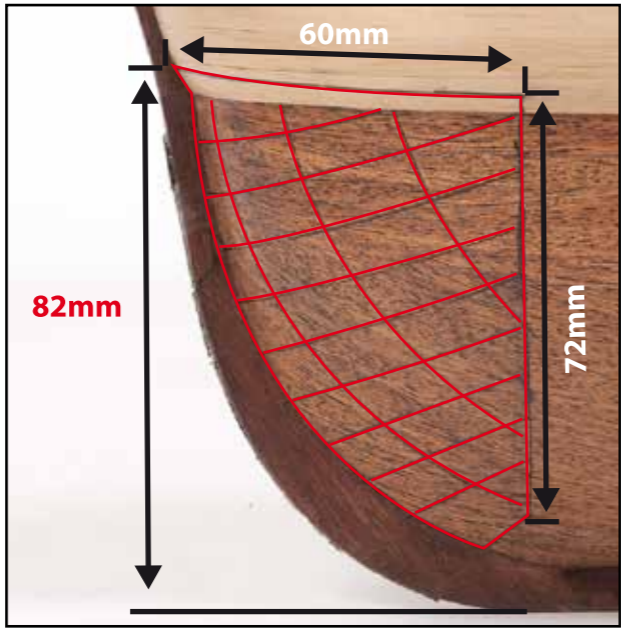
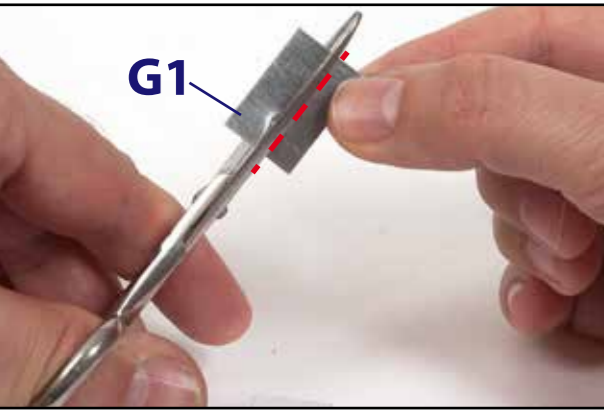

H

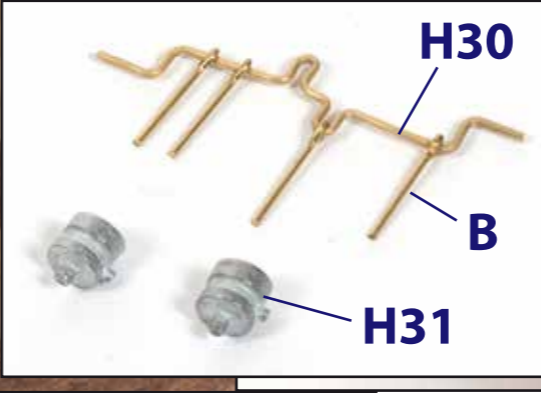
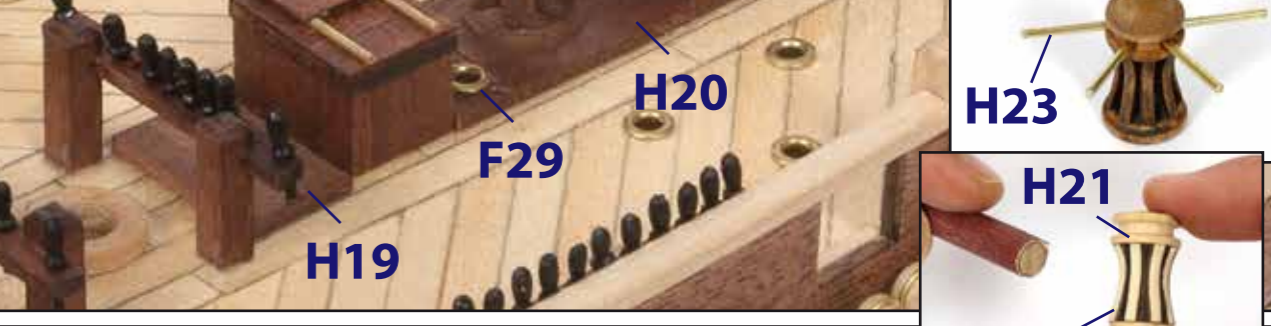
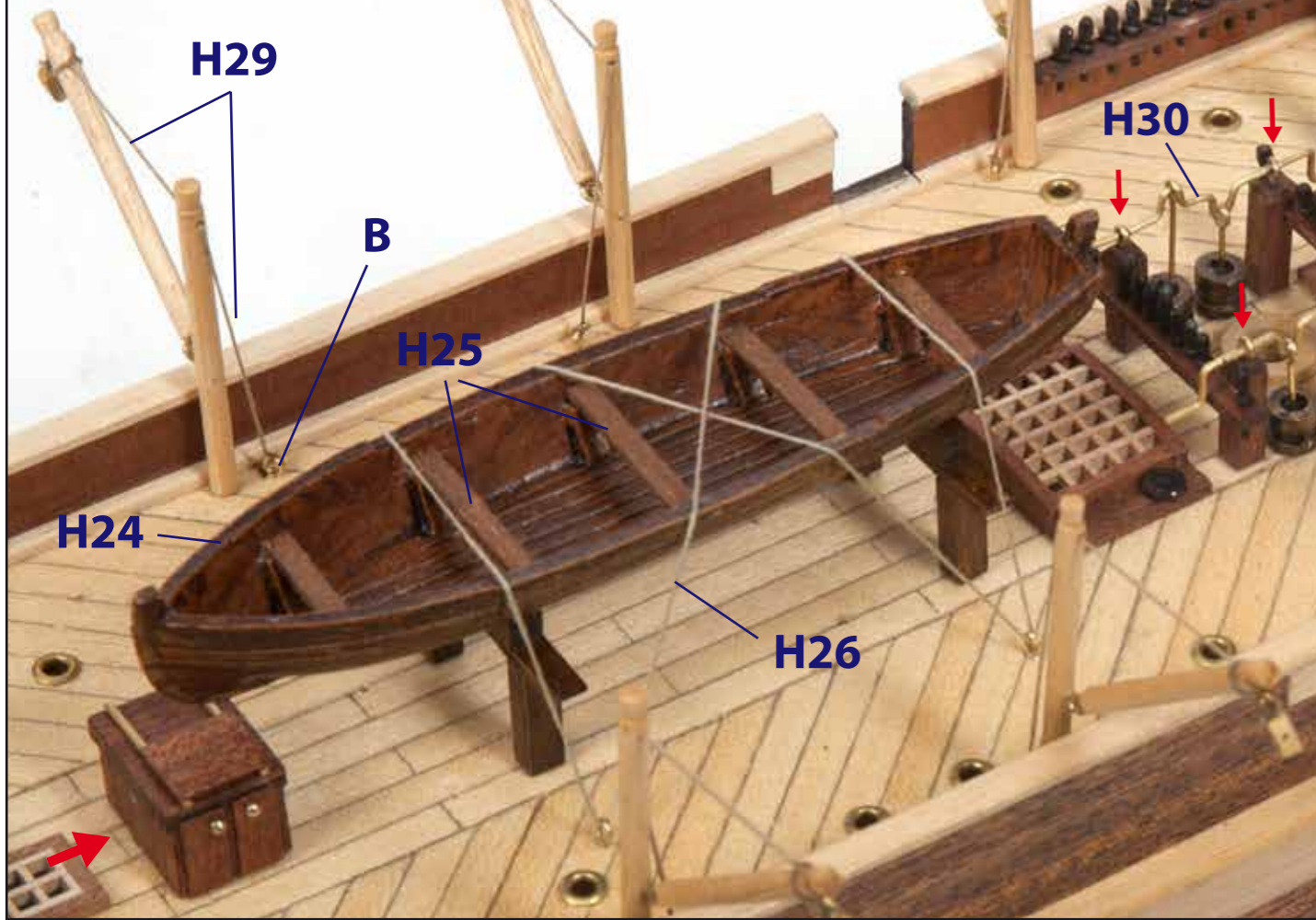
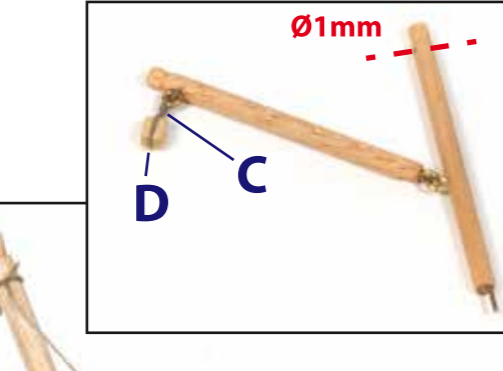
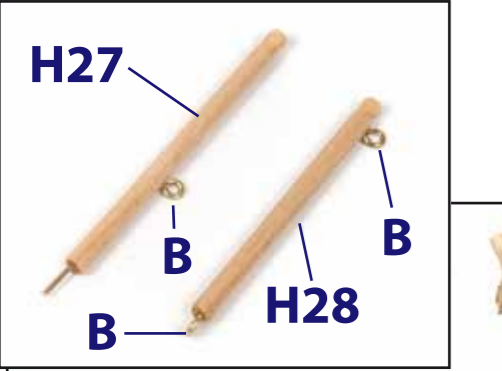
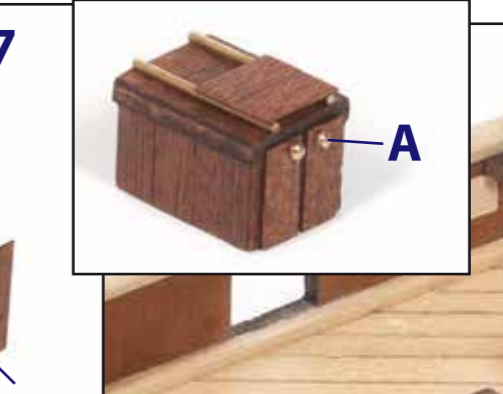
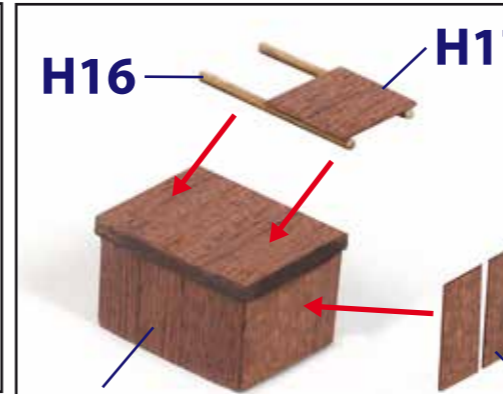
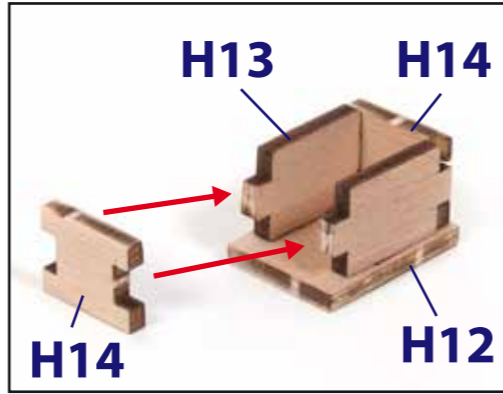
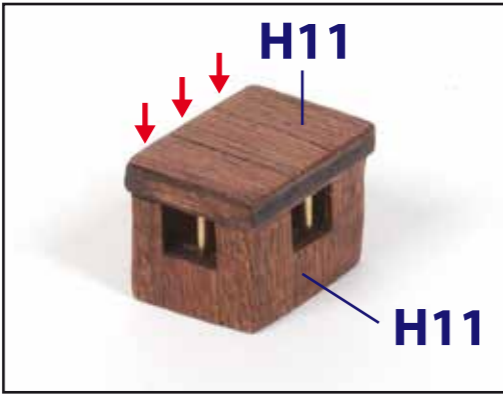
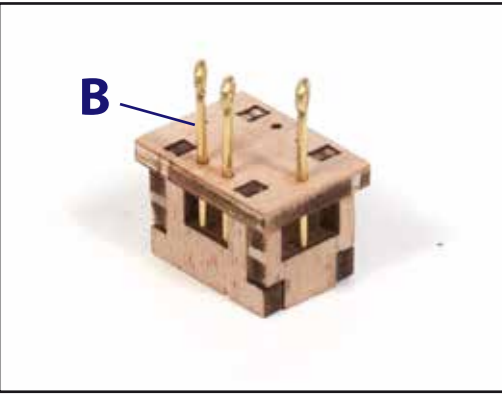
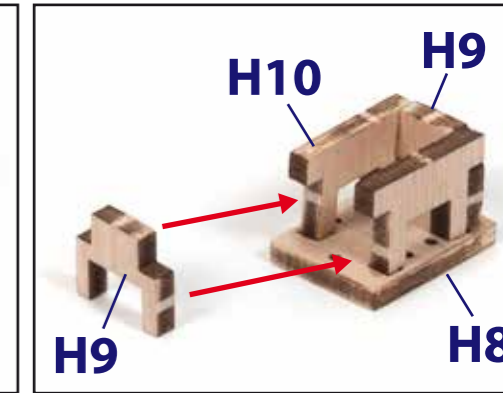
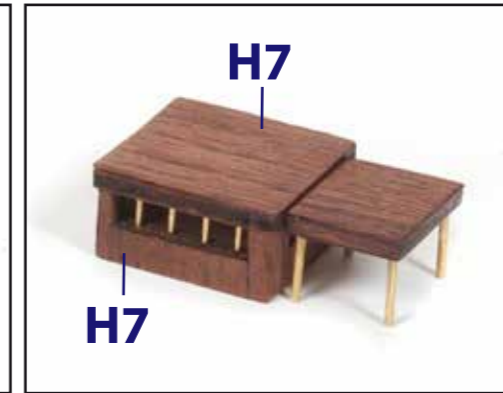
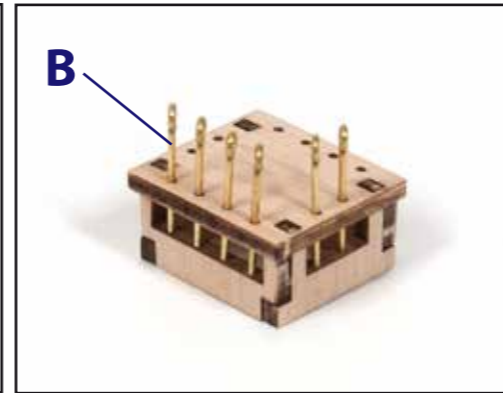
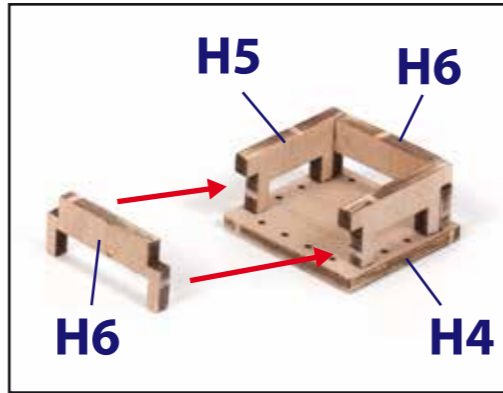
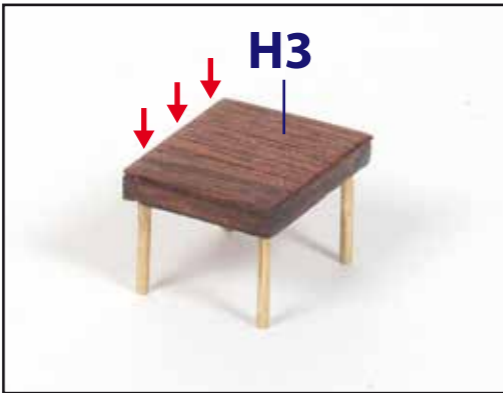
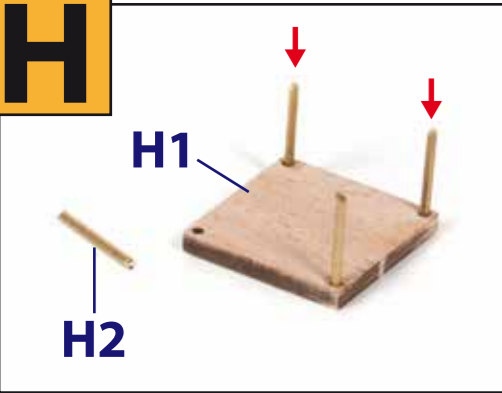

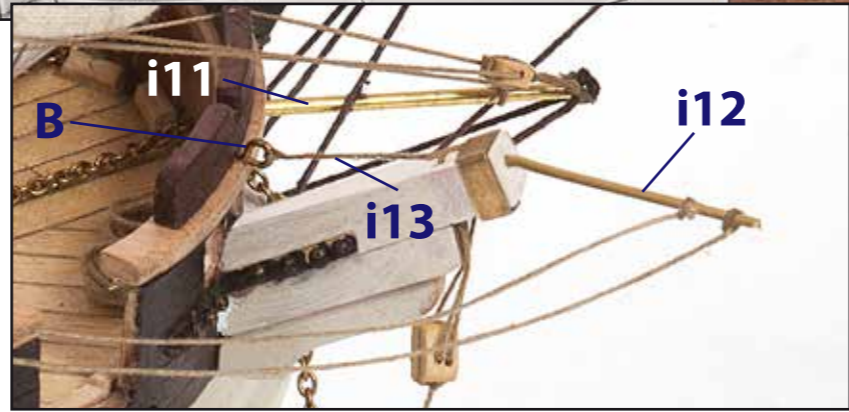
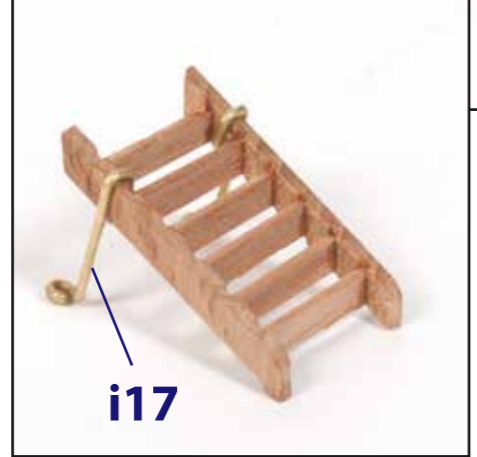
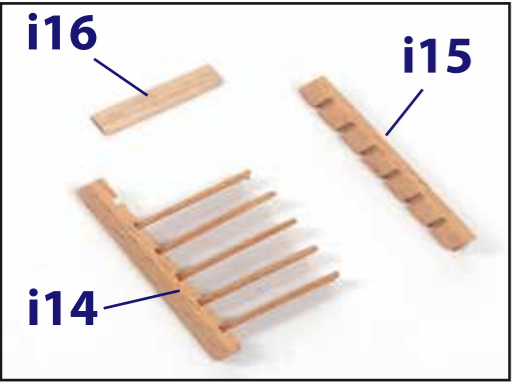
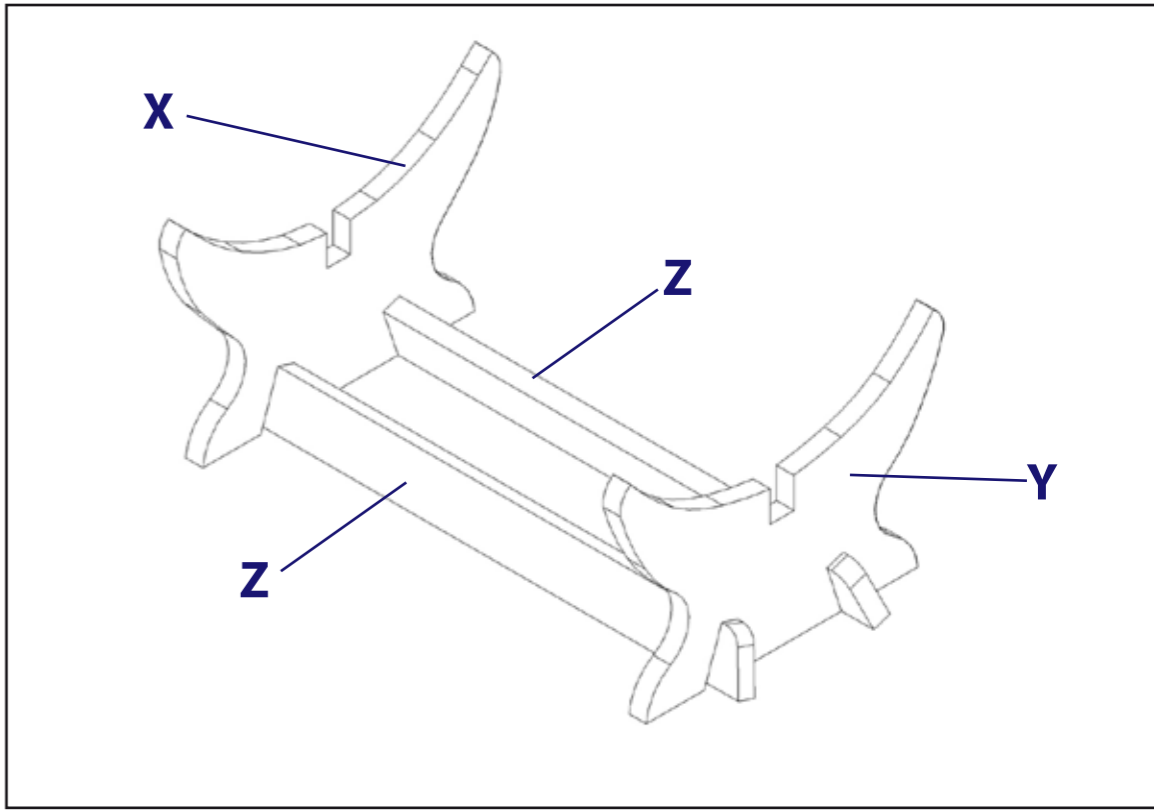
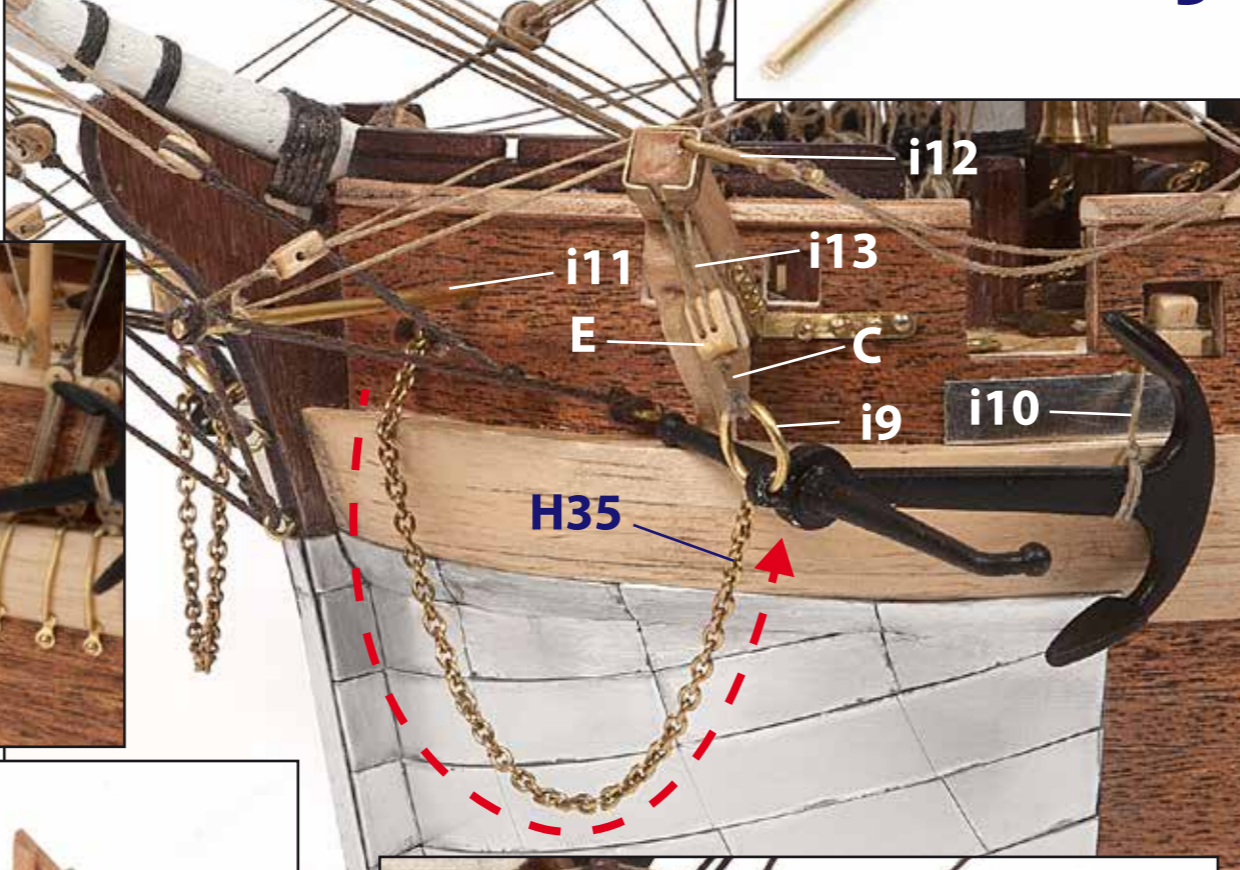
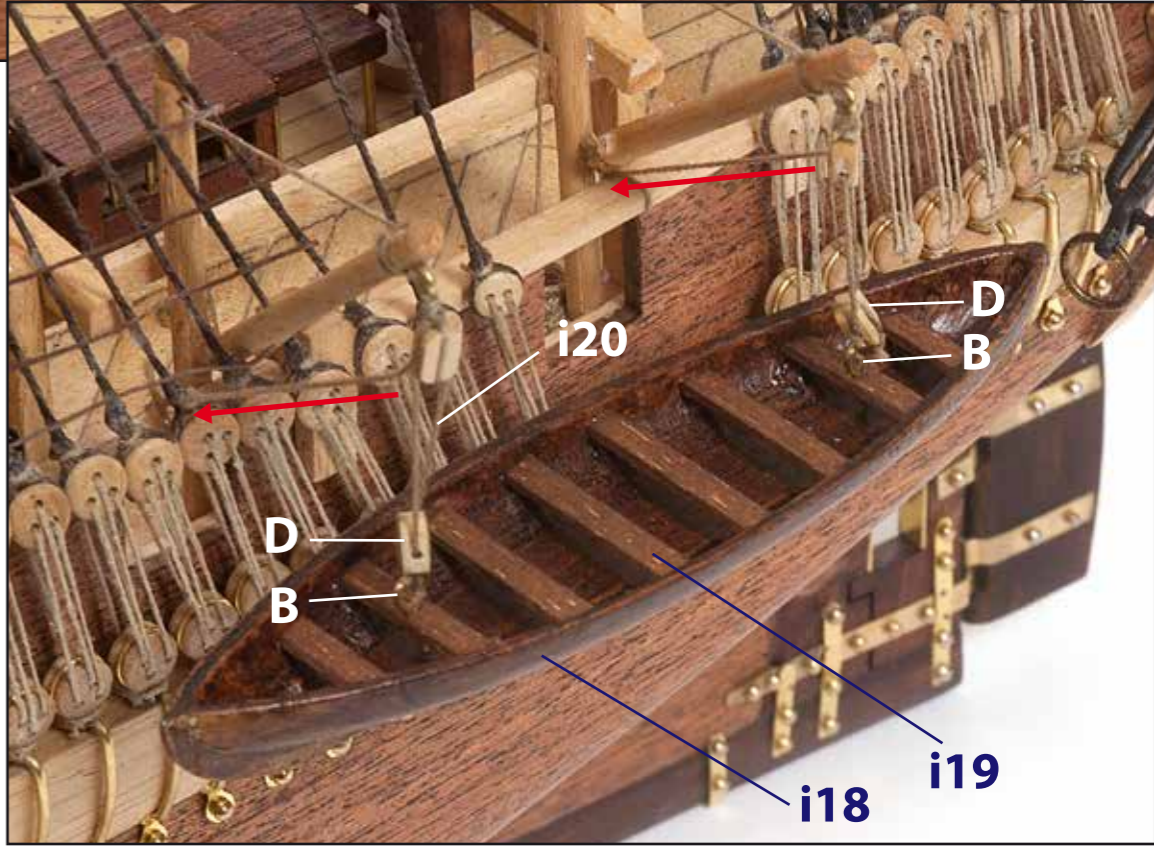
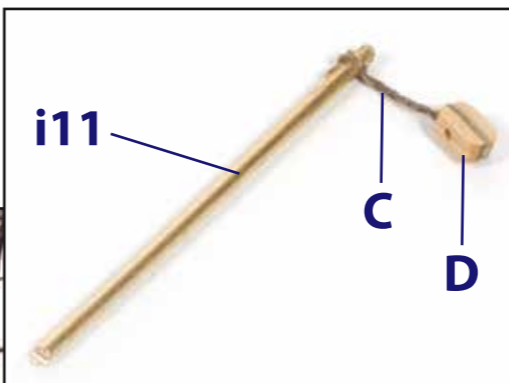
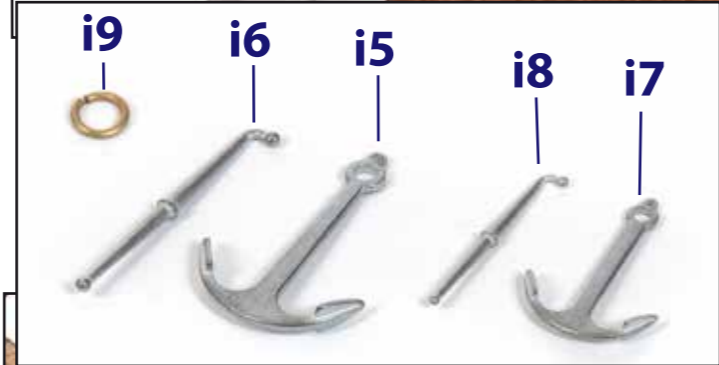
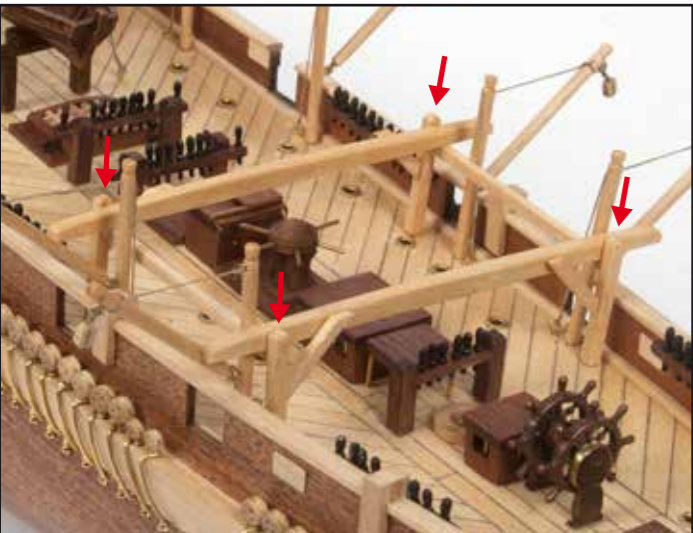
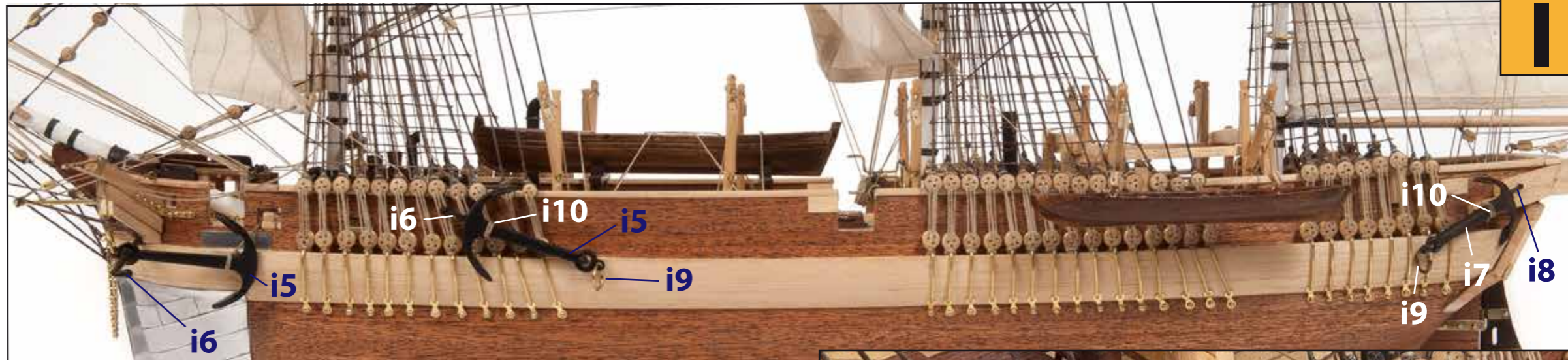
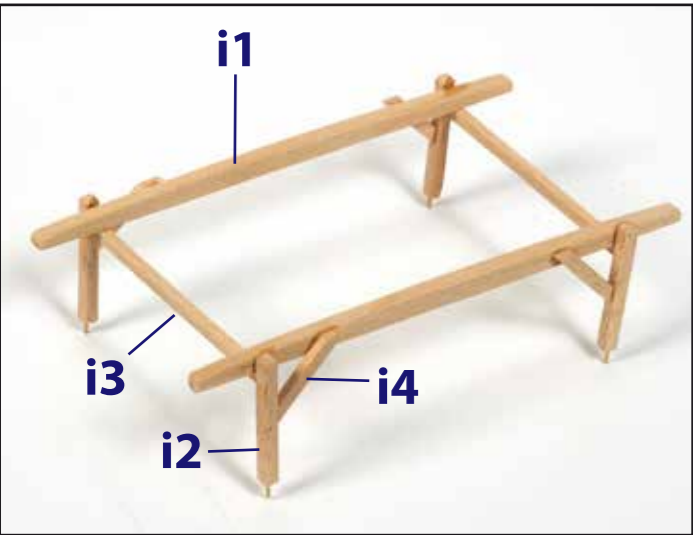

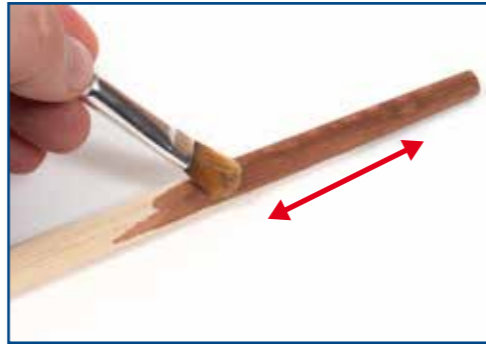
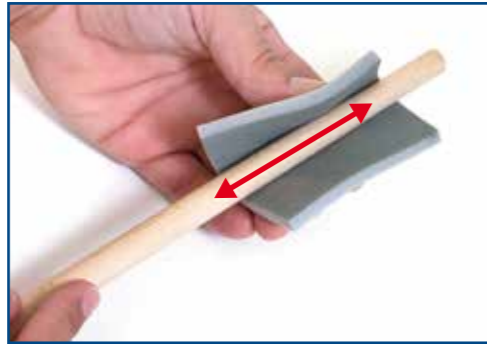
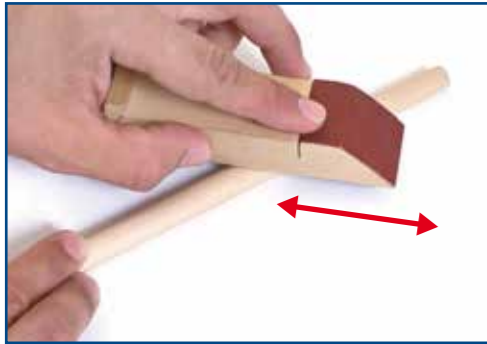

Consultar los planos de mástiles
Consult the masts drawings
Consulte os desenhos dos mastros
Consulter les dessins des mâts
Konsultieren Sie die Mastenzeichnungen
Обратитесь к рисункам мачты
Consultare i disegni degli alberi

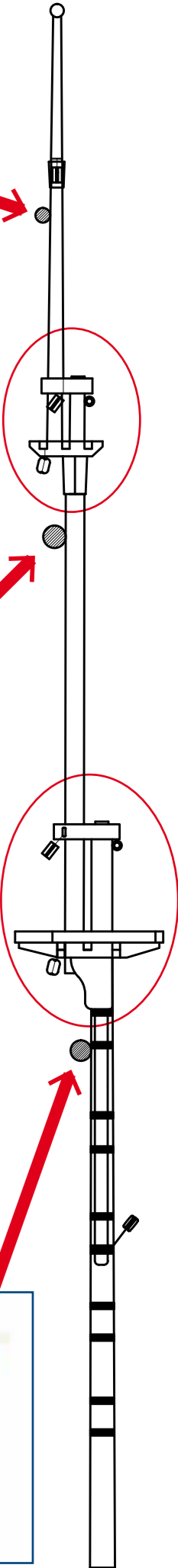
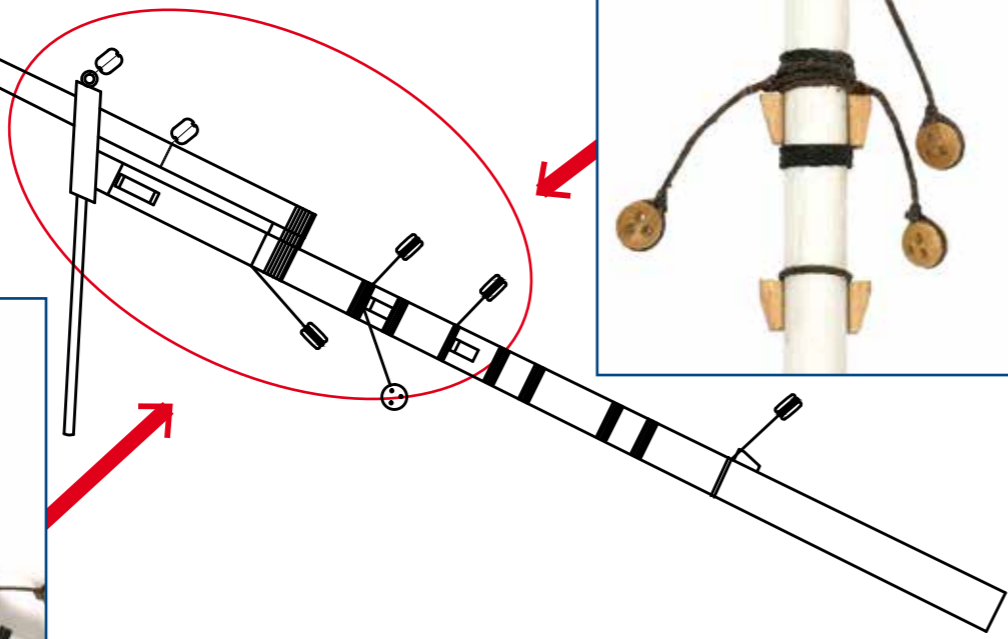
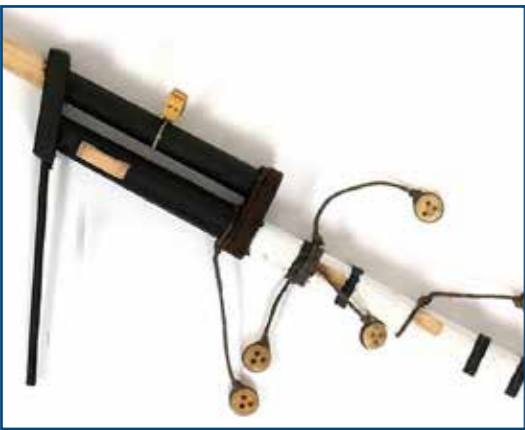

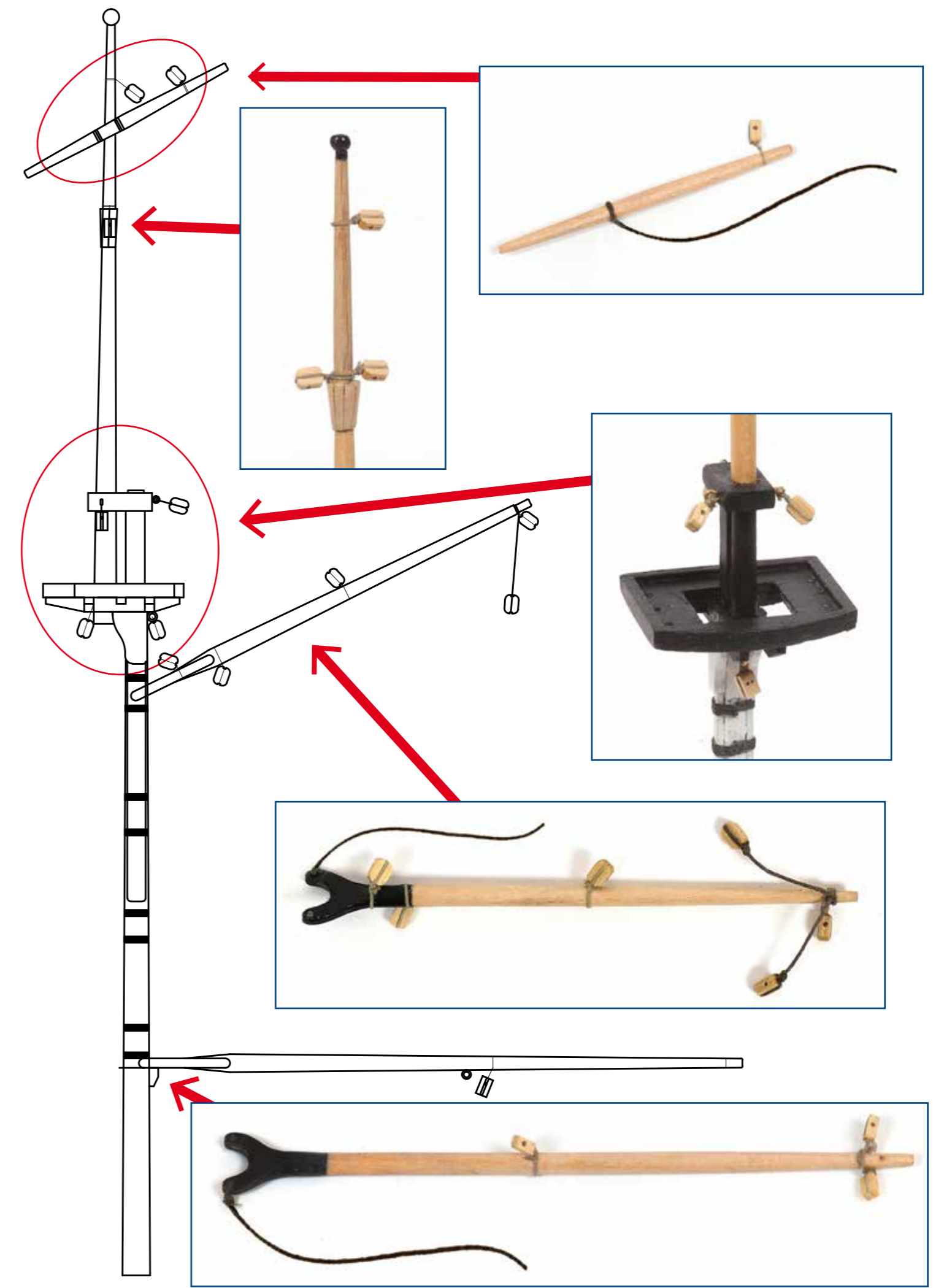
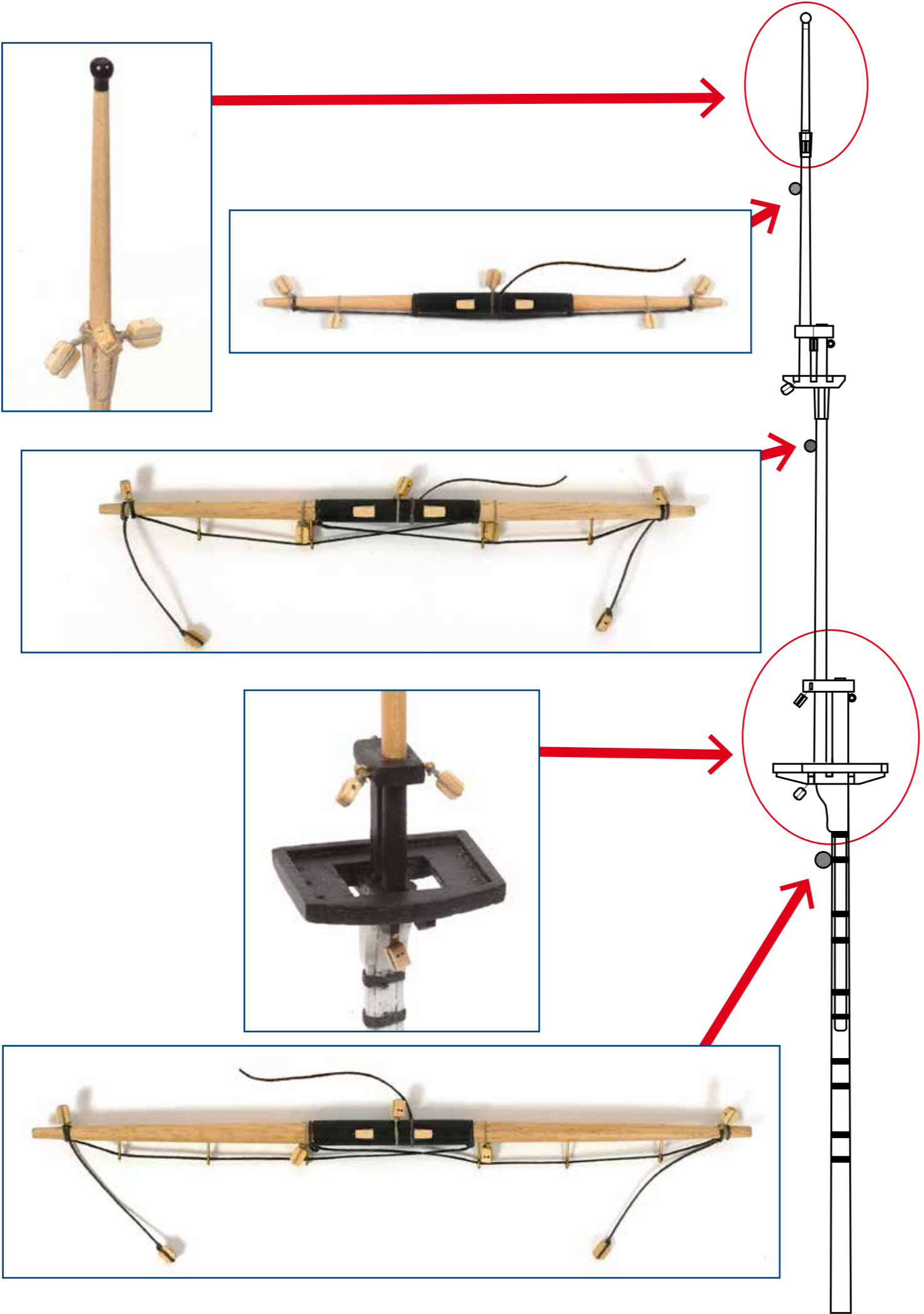

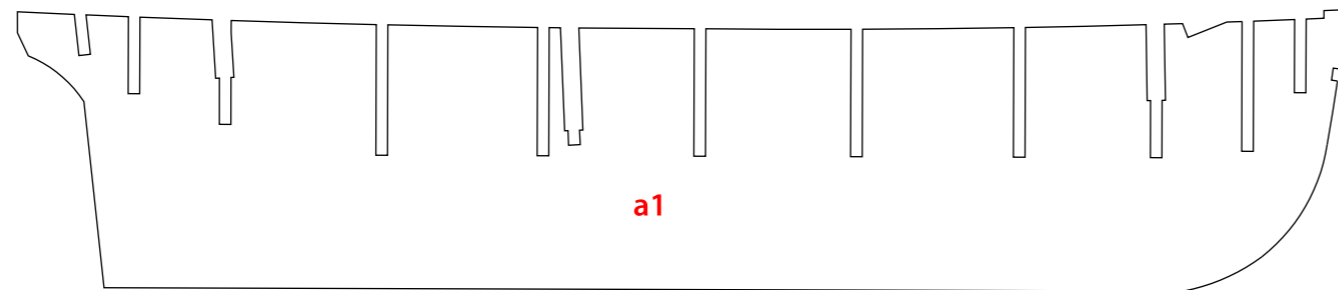

12004-1

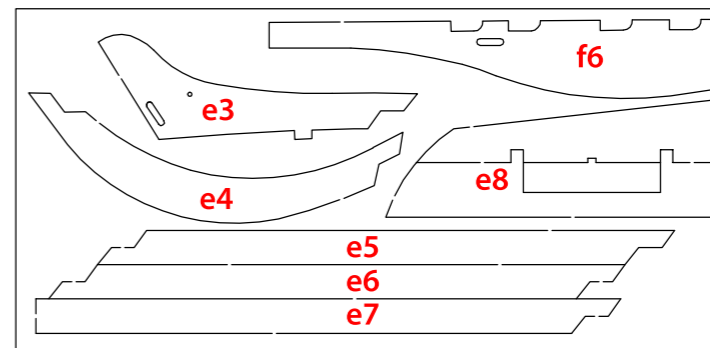

12004-6

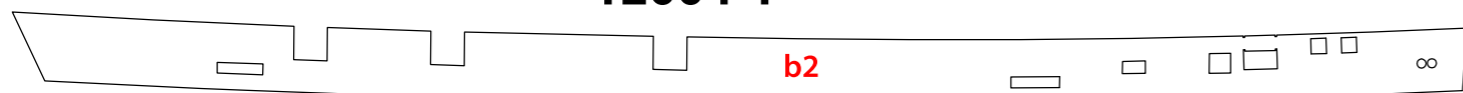

12004-5

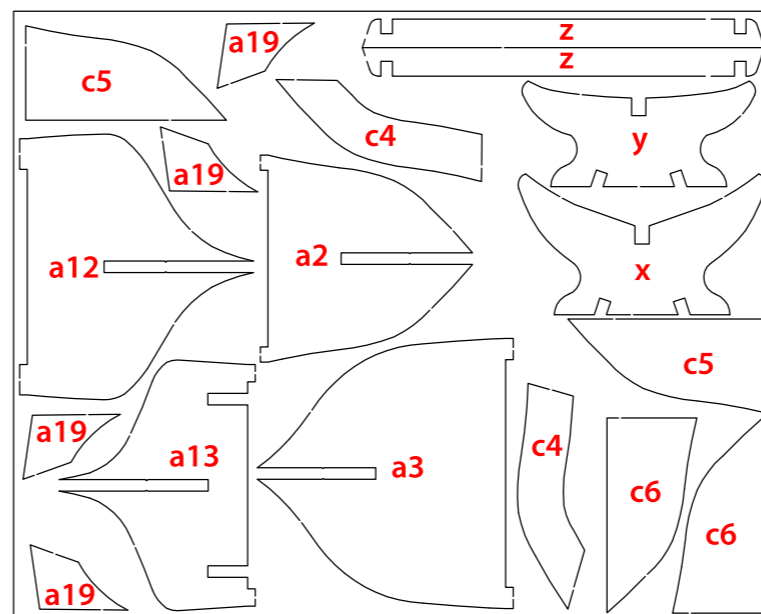

12004-3

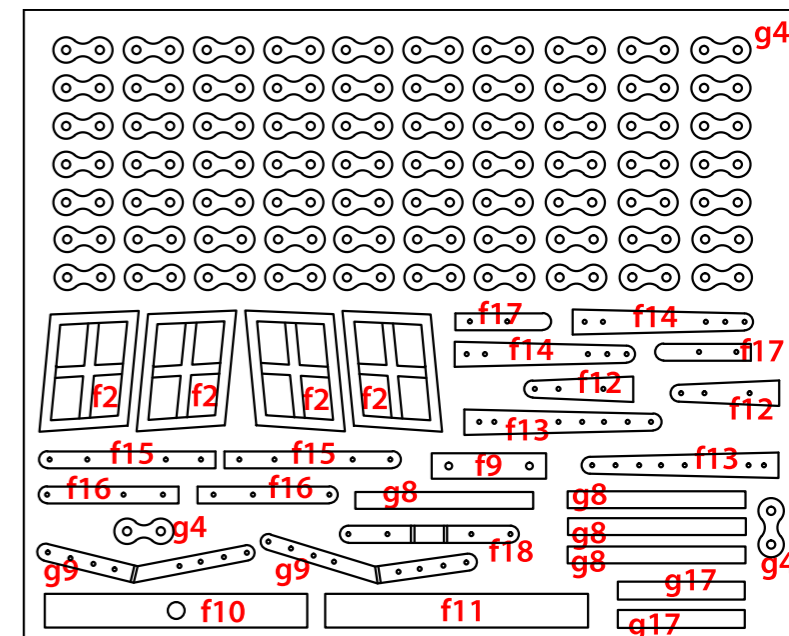

12004-10

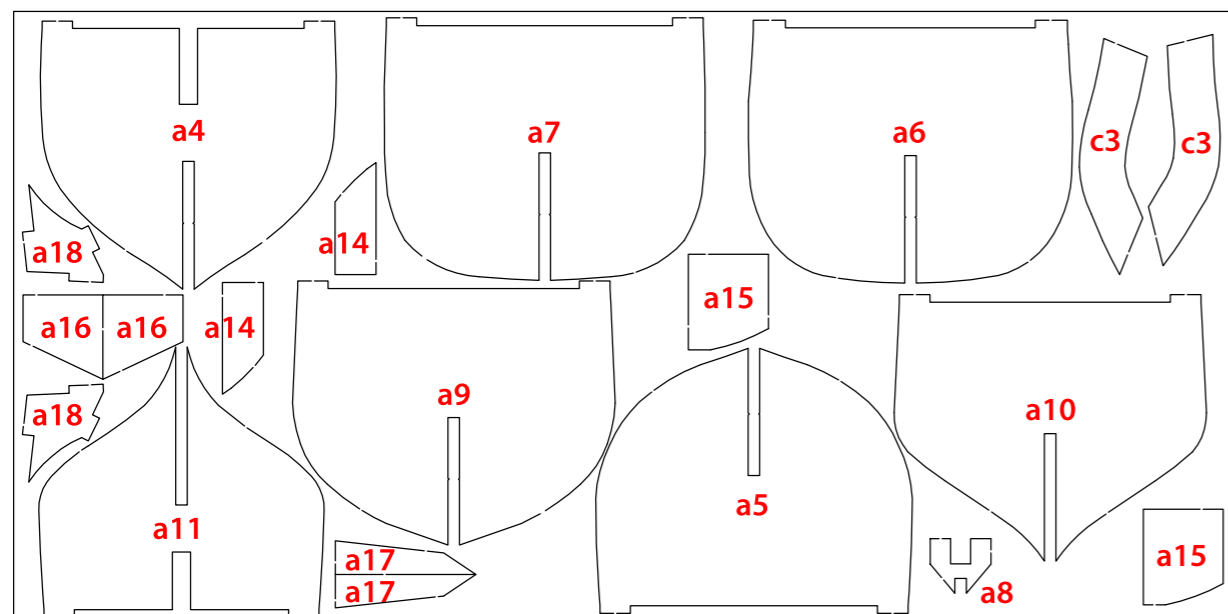

12004-2

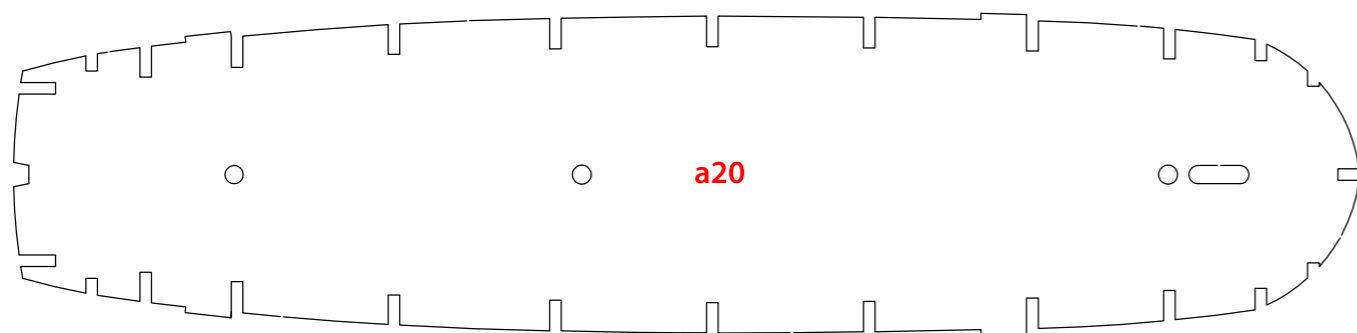

12004-4

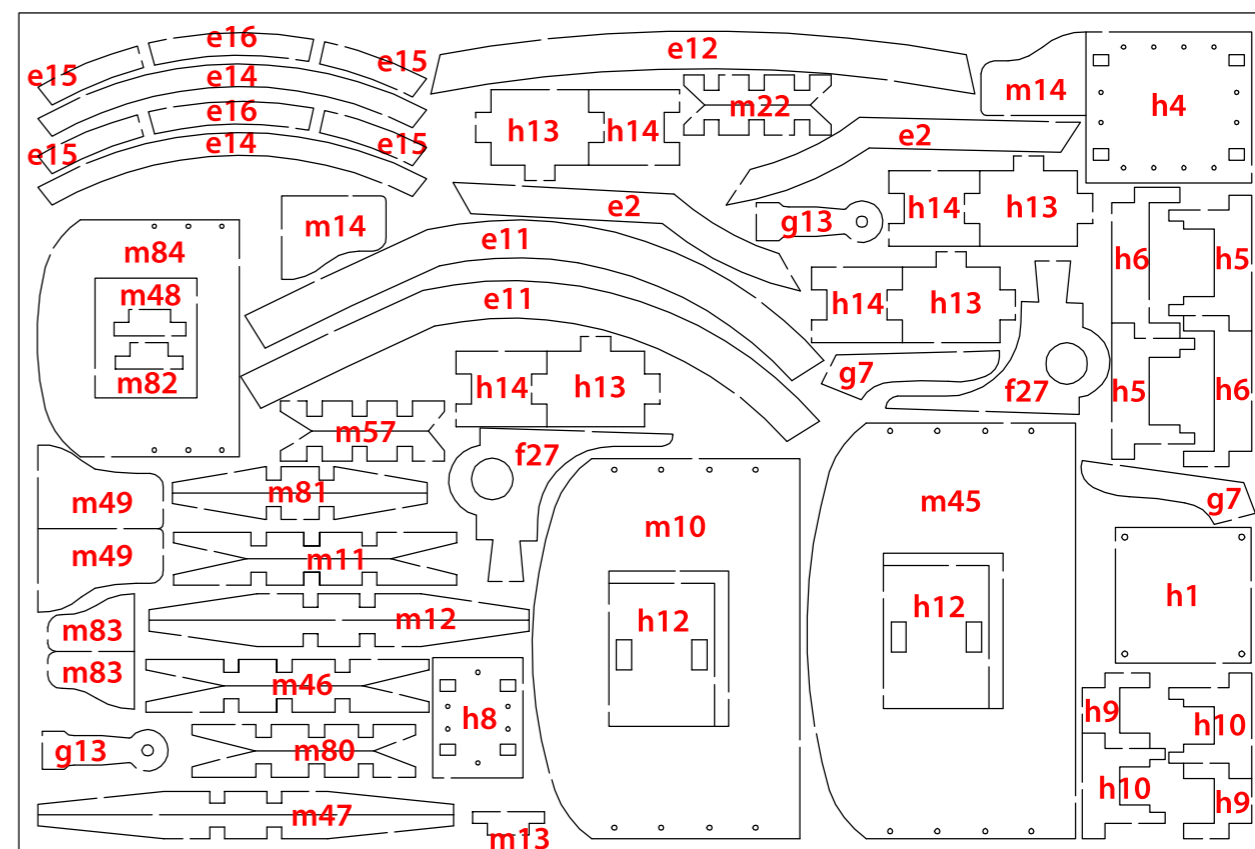

12004-7

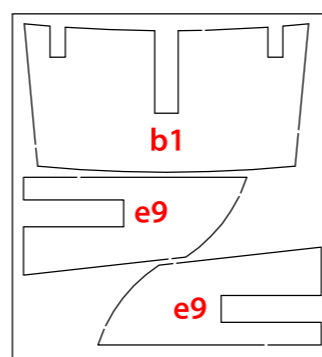

12004-8

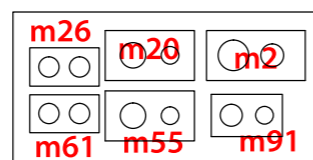

12004-9



Terror

PL-01

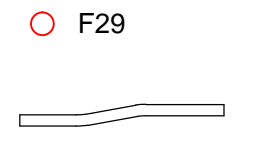
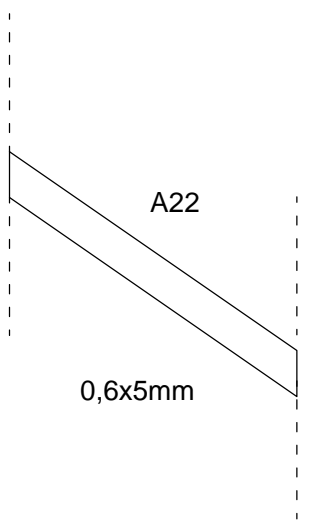
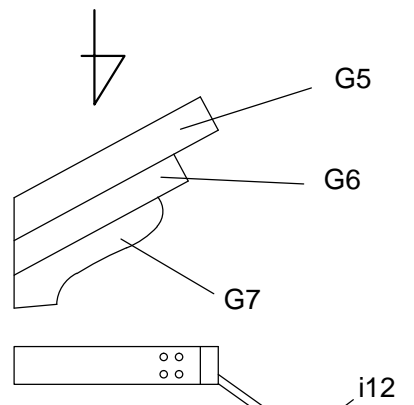
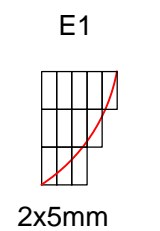
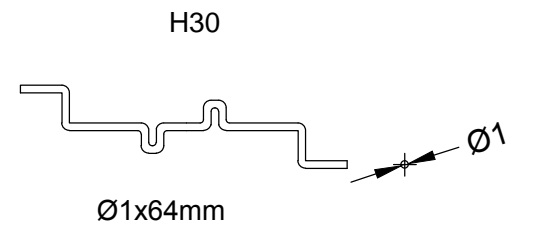
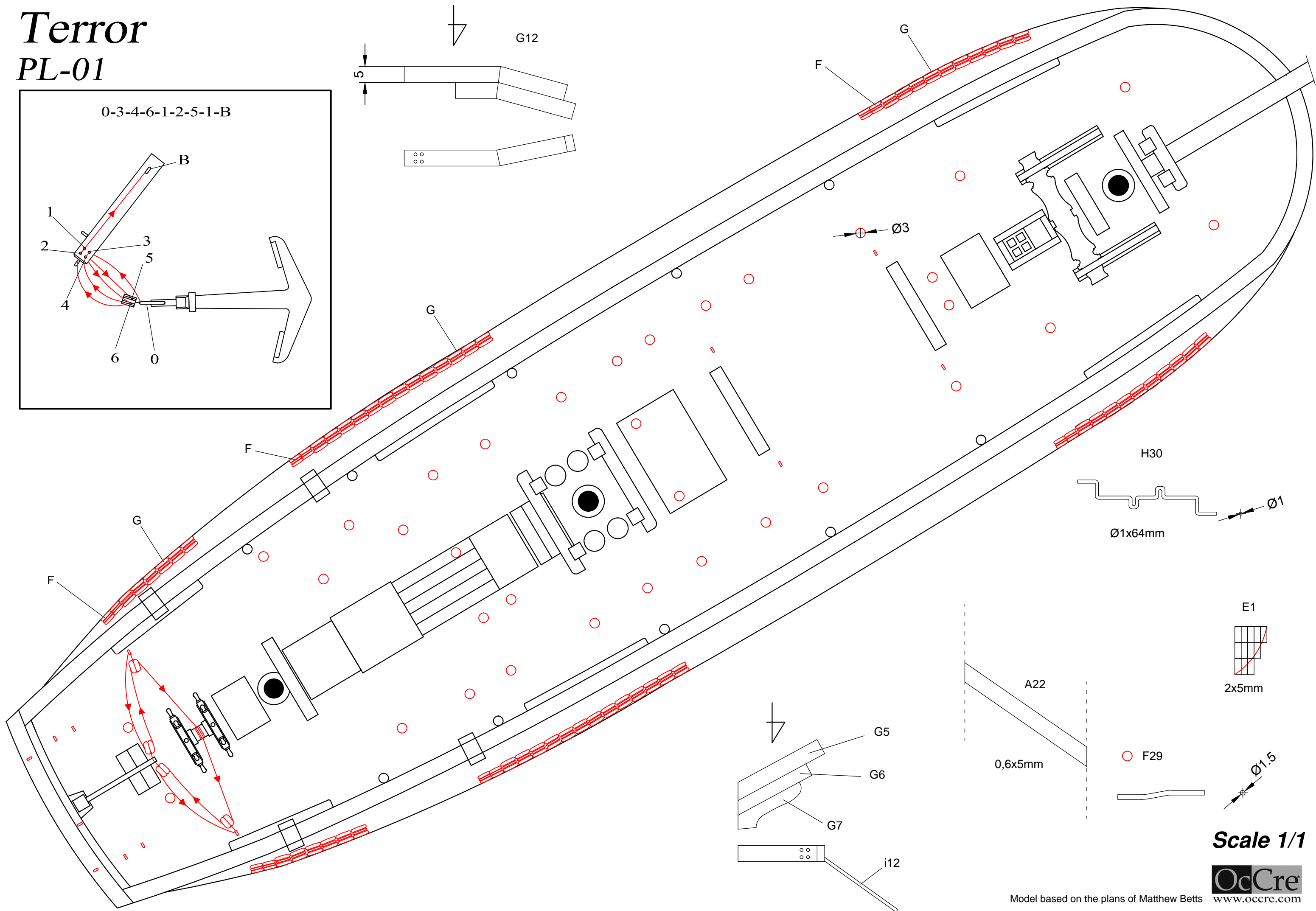
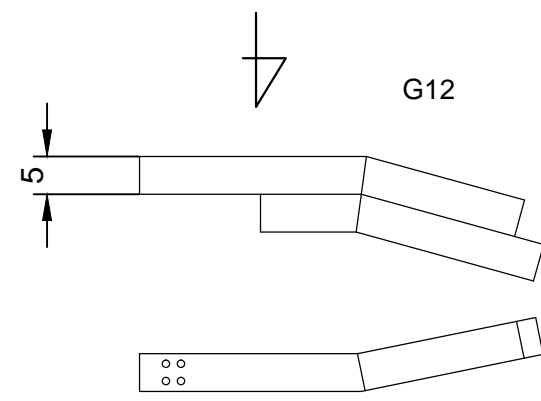
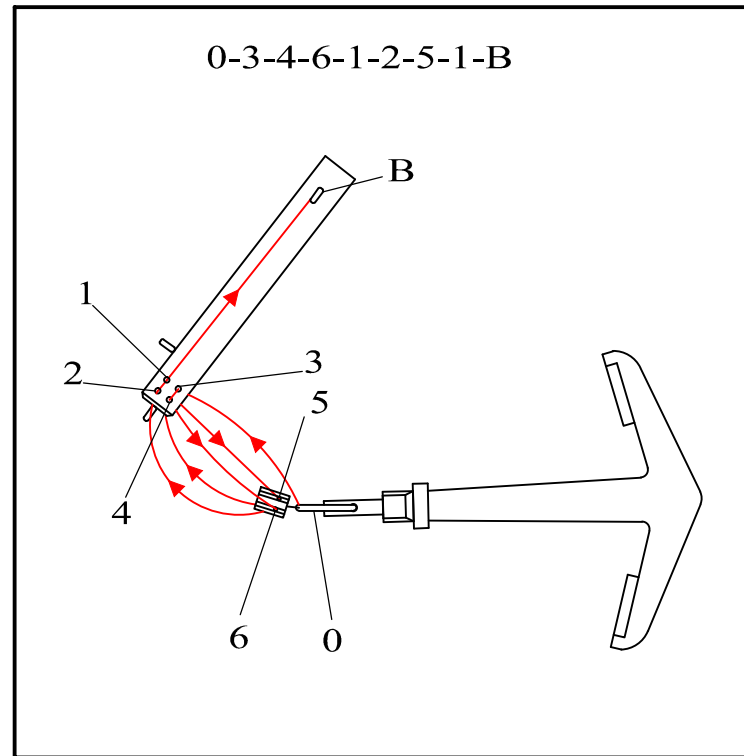

Scale 1/1



Model based on the plans of Matthew Betts

www.occre.com

Terror

Model based on the plans of Matthew Betts

OcCre
Ocio Creativo

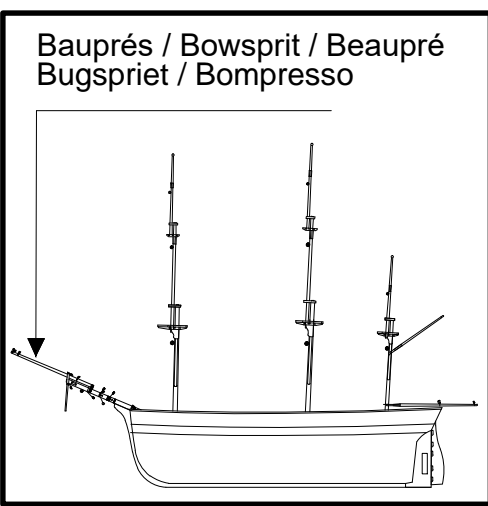
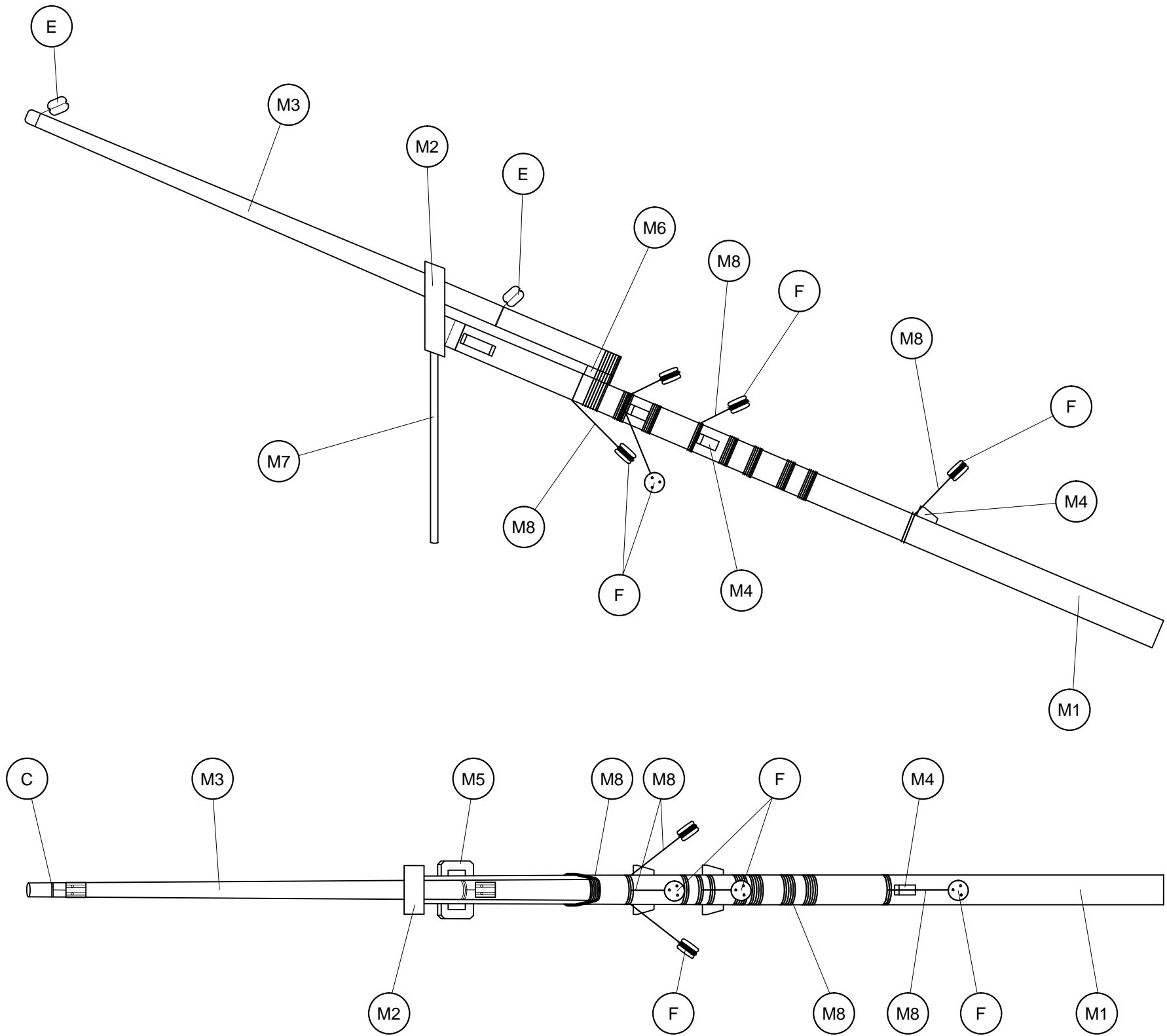

Scale 1/1

M1	ø6x162	Tilo / Lime wood / Tilleul / Linde / Tiglio	M7	ø1,5x38	Latón / Brass / Laiton / Messing / Ottone
M2	Precortado / Precut / Prédécoupé / Vorgeschnitten / Pretagliato	Tablero / Plywood / Planché / Sperrholz / Tavola	M8	ø0,50x100	Hilo marrón / Brown thread / Fil brun / braunes Baumwollfaden / Filo marrone
M3	ø4x130	Tilo / Lime wood / Tilleul / Linde / Tiglio	C	ø0,15x100	Hilo crudo / Raw thread / Fil brut / Rohes Baumwollfaden / Filo crudo
M4	2x2x4	Tilo / Lime wood / Tilleul / Linde / Tiglio	E	4	Composite / Composite / Composite / Composite / Composite
M5	2x3x5	Tilo / Lime wood / Tilleul / Linde / Tiglio	F	ø4	Composite / Composite / Composite / Composite / Composite
M6	2x2x4	Tilo / Lime wood / Tilleul / Linde / Tiglio			



Moton
Blocks
Blockrolle
Poulie
Bozzello



Cuadernal
Double blocks
Block
Poulie double
Pastecca



Vigota
Dead eyes
Jungferblock
Cap de mouton
Bigotta



Vigota ciega
Dead blocks
Jungferblock
Moque
Bigotta cieca



Anilla
Rings
Öse
Oeil
Anello



Cáncamo
Eyebolts
Tragöse
Piton à oeil
Caviglia di ferro ad anello

Terror

Model based on the plans of Matthew Betts

OcCre
Ocio Creativo

Palo trinquete / Fore mast
Mât de misaine / Fockmast
Albero trinchetto

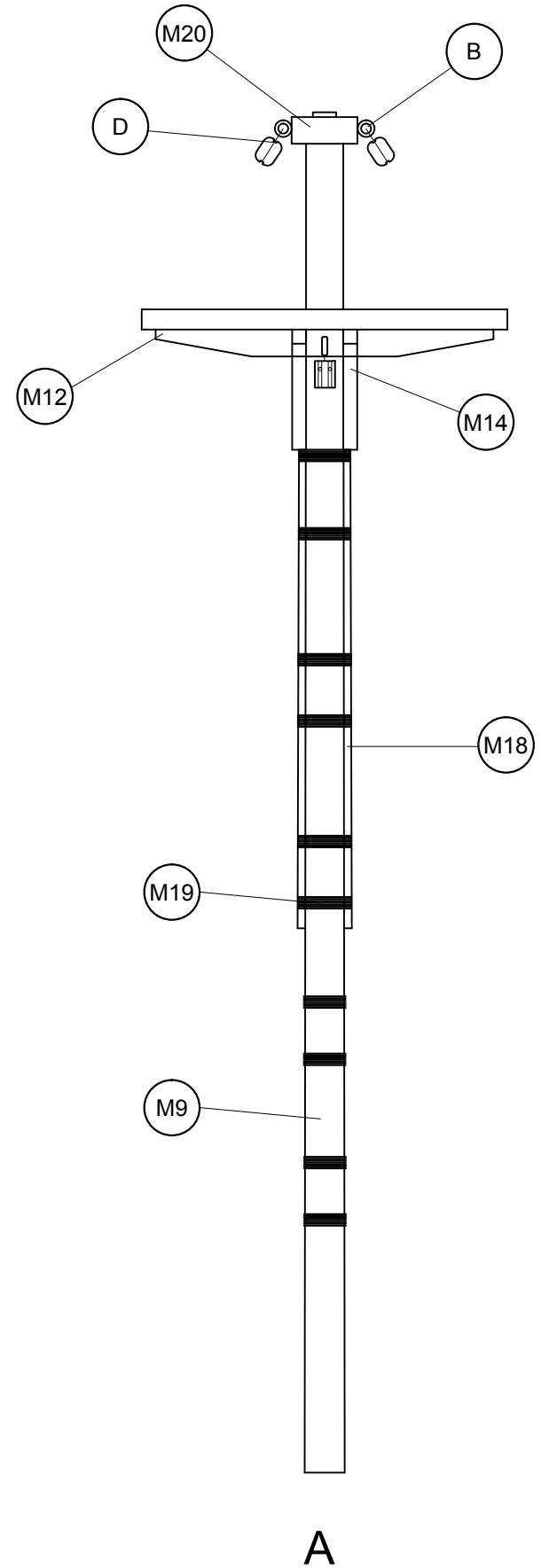
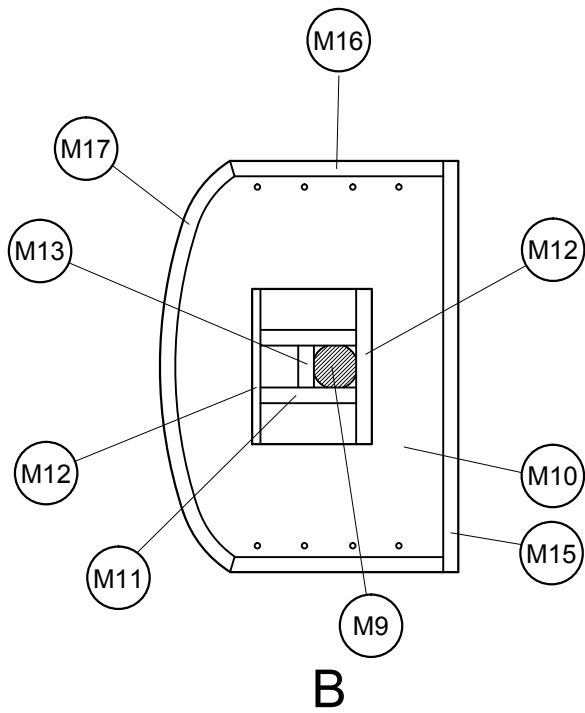
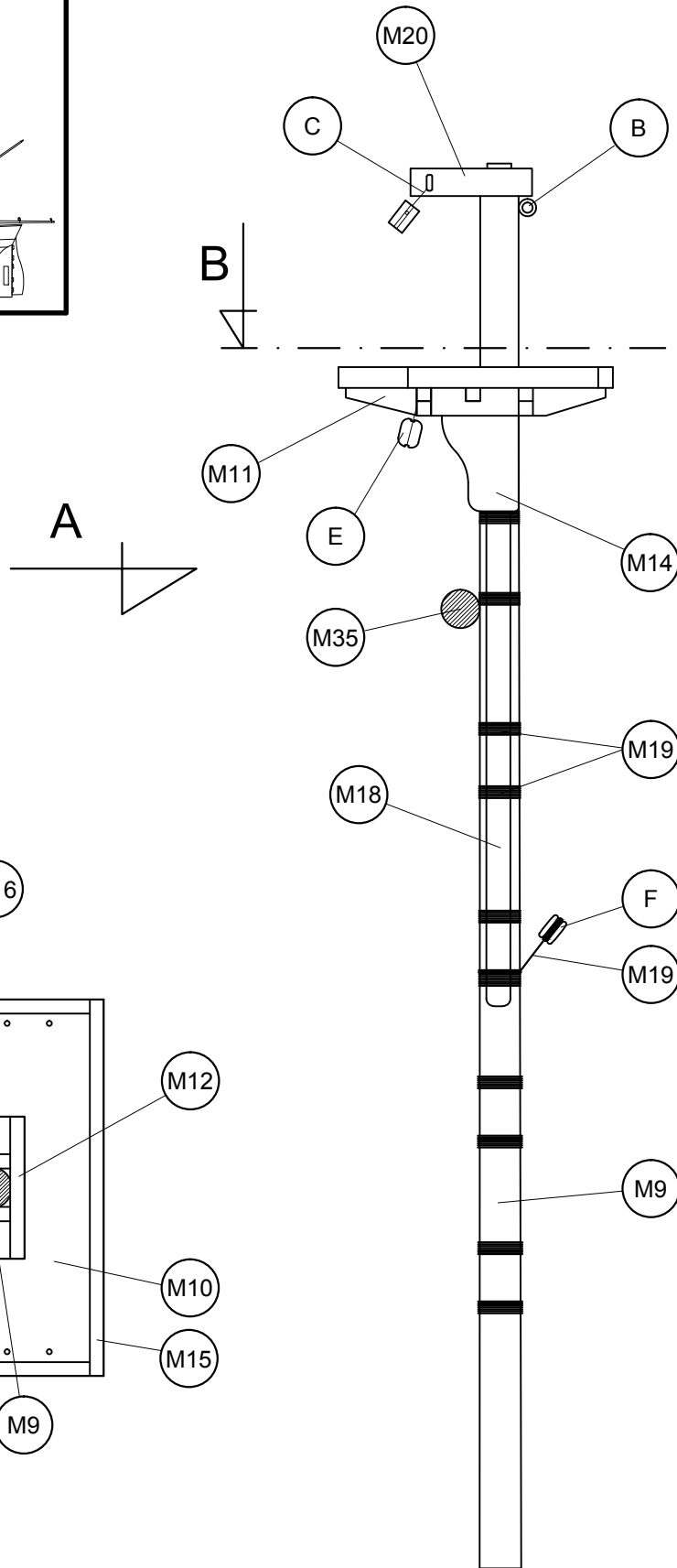
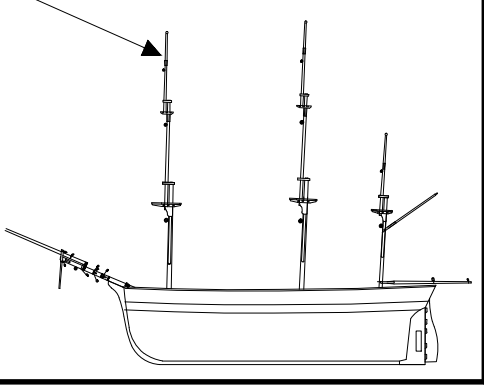

Scale 1/1

M9	ø6x203	Tilo / Lime wood / Tilleul / Linde / Tiglio	M18	1x4x69	Tilo / Lime wood / Tilleul / Linde / Tiglio
M10	Precortado / Precut / Prédécoupé / Vorgeschnitten / Pretagliato	Tablero / Plywood / Planche / Sperrholz / Tavola	M19	ø0,50x100	Hilo marrón / Brown thread / Fil brun / braunes Baumwollfaden / Filo marrone
M11	Precortado / Precut / Prédécoupé / Vorgeschnitten / Pretagliato	Tablero / Plywood / Planche / Sperrholz / Tavola	M20	Precortado / Precut / Prédécoupé / Vorgeschnitten / Pretagliato	Tablero / Plywood / Planche / Sperrholz / Tavola
M12	Precortado / Precut / Prédécoupé / Vorgeschnitten / Pretagliato	Tablero / Plywood / Planche / Sperrholz / Tavola	B	15	Latón / Brass / Laiton / Messing / Ottone
M13	Precortado / Precut / Prédécoupé / Vorgeschnitten / Pretagliato	Tablero / Plywood / Planche / Sperrholz / Tavola	C	ø0,15x100	Hilo crudo / Raw thread / Fil brut / Rohes Baumwollfaden / Filo crudo
M14	Precortado / Precut / Prédécoupé / Vorgeschnitten / Pretagliato	Tablero / Plywood / Planche / Sperrholz / Tavola	D	4	Composite / Composite / Composite / Composite / Composite
M15	2x3x55	Tilo / Lime wood / Tilleul / Linde / Tiglio	E	4	Composite / Composite / Composite / Composite / Composite
M16	2x3x28	Tilo / Lime wood / Tilleul / Linde / Tiglio	F	ø4	Composite / Composite / Composite / Composite / Composite
M17	2x3x60	Tilo / Lime wood / Tilleul / Linde / Tiglio			

Terror

Model based on the plans of Matthew Betts

OcCre
Ocio Creativo

Palo trinquete / Fore mast / Mât de misaine
Fockmast / Albero trinchetto

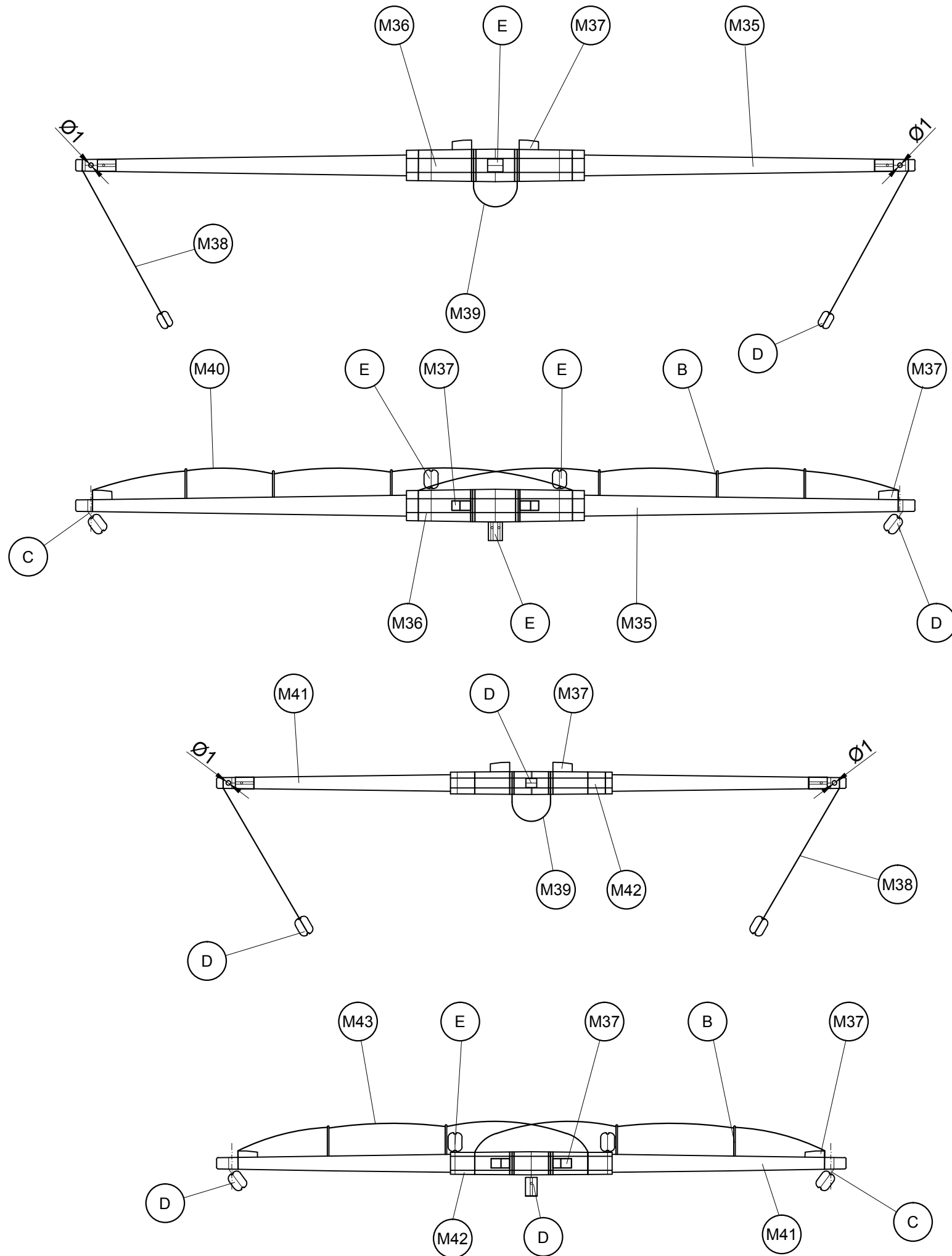

Scale 1/1

M35	ø5x180	Tilo / Lime wood / Tilleul / Linde / Tiglio	M42	1x3x35	Tilo / Lime wood / Tilleul / Linde / Tiglio
M36	1x3x38	Tilo / Lime wood / Tilleul / Linde / Tiglio	M43	ø0,50x120	Hilo marrón / Brown thread / Fil brun /braunes Baumwollfaden / Filo marrone
M37	2x2x4	Tilo / Lime wood / Tilleul / Linde / Tiglio	B	15	Latón / Brass / Laiton / Messing / Ottone
M38	ø0,50x75	Hilo marrón / Brown thread / Fil brun /braunes Baumwollfaden / Filo marrone	C	ø0,15x100	Hilo crudo / Raw thread / Fil brut / Rohes Baumwollfaden / Filo crudo
M39	ø0,50x100	Hilo marrón / Brown thread / Fil brun /braunes Baumwollfaden / Filo marrone	D	4	Composite / Composite / Composite / Composite / Composite
M40	ø0,50x140	Hilo marrón / Brown thread / Fil brun /braunes Baumwollfaden / Filo marrone	E	4	Composite / Composite / Composite / Composite / Composite
M41	ø4x135	Tilo / Lime wood / Tilleul / Linde / Tiglio			

Terror

Model based on the plans of Matthew Betts

OcCre
Ocio Creativo

Palo trinquete / Fore mast / Mât de misaine
Fockmast / Albero trinchetto

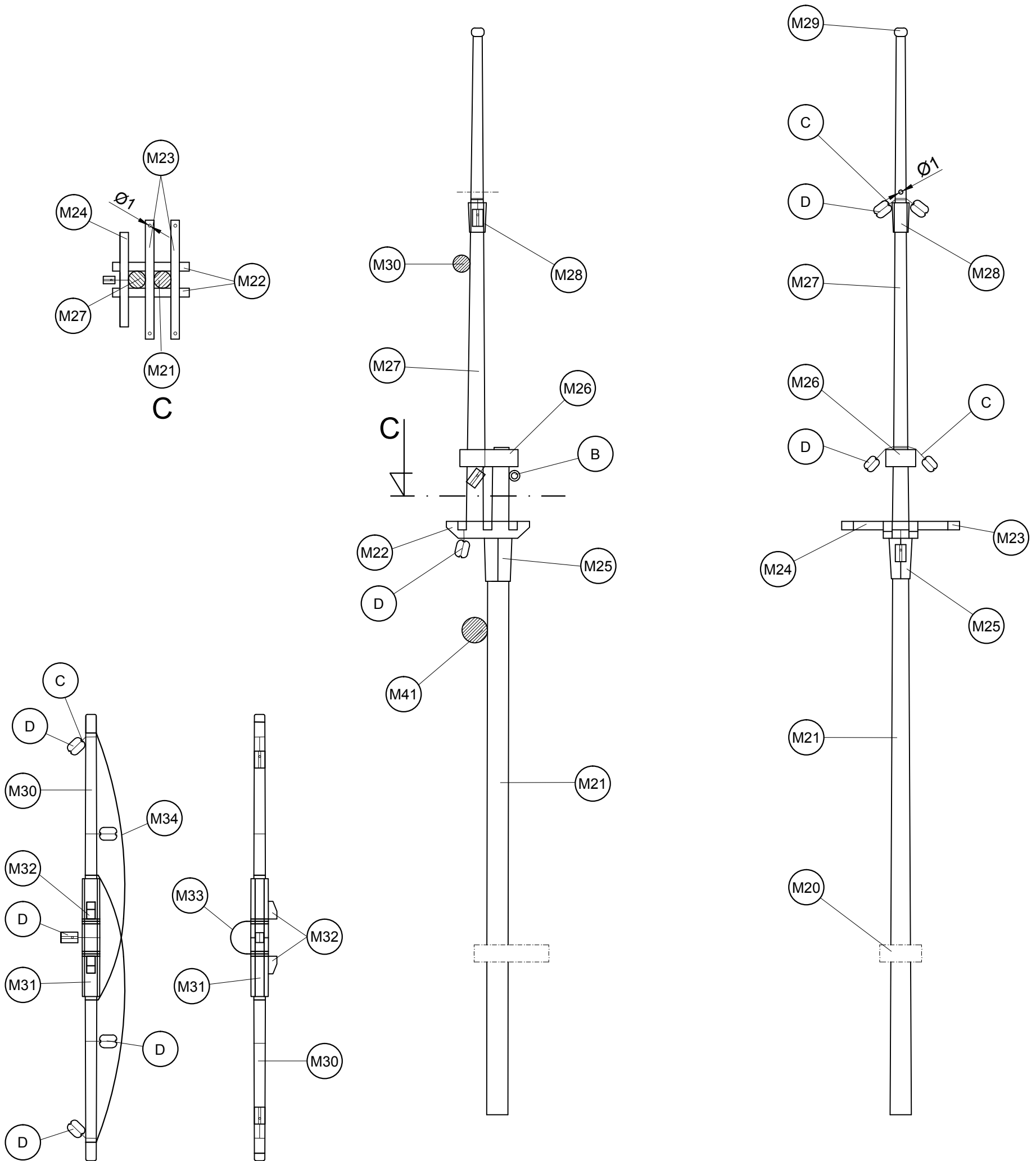

Scale 1/1

M21	ø5x157	Tilo / Lime wood / Tilleul / Linde / Tiglio	M29	ø3	Cristal / Crystal / Crystal / Kristall / Cristallo
M22	Precortado / Precut / Prédécoupé / Vorgeschnitten / Pretagliato	Tablero / Plywood / Planche / Sperrholz / Tavola	M30	ø3x105	Tilo / Lime wood / Tilleul / Linde / Tiglio
M23	2x2x28	Tilo / Lime wood / Tilleul / Linde / Tiglio	M31	1x3x28	Tilo / Lime wood / Tilleul / Linde / Tiglio
M24	2x2x22	Tilo / Lime wood / Tilleul / Linde / Tiglio	M32	2x2x5	Tilo / Lime wood / Tilleul / Linde / Tiglio
M25	1x3x11	Tilo / Lime wood / Tilleul / Linde / Tiglio	M33	ø0,50x100	Hilo marrón / Brown thread / Fil brun /braunes Baumwollfaden / Filo marrone
M26	Precortado / Precut / Prédécoupé / Vorgeschnitten / Pretagliato	Tablero / Plywood / Planche / Sperrholz / Tavola	M34	ø0,50x110	Hilo marrón / Brown thread / Fil brun /braunes Baumwollfaden / Filo marrone
M27	ø4x120	Tilo / Lime wood / Tilleul / Linde / Tiglio	C	ø0,15x100	Hilo crudo / Raw thread / Fil brut / Rohes Baumwollfaden / Filo crudo
M28	1x3x10	Tilo / Lime wood / Tilleul / Linde / Tiglio	D	4	Composite / Composite / Composite / Composite / Composite

Terror

Model based on the plans of Matthew Betts

OcCre
Ocio Creativo

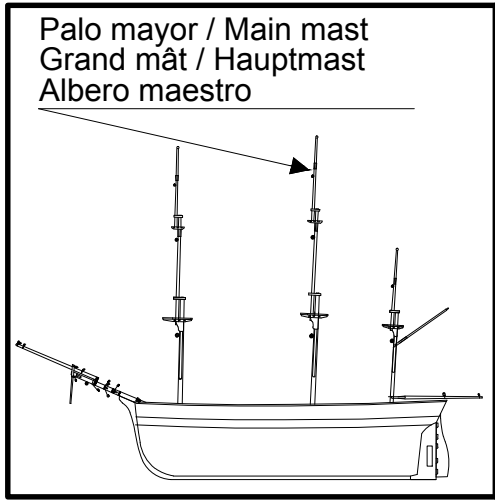

A

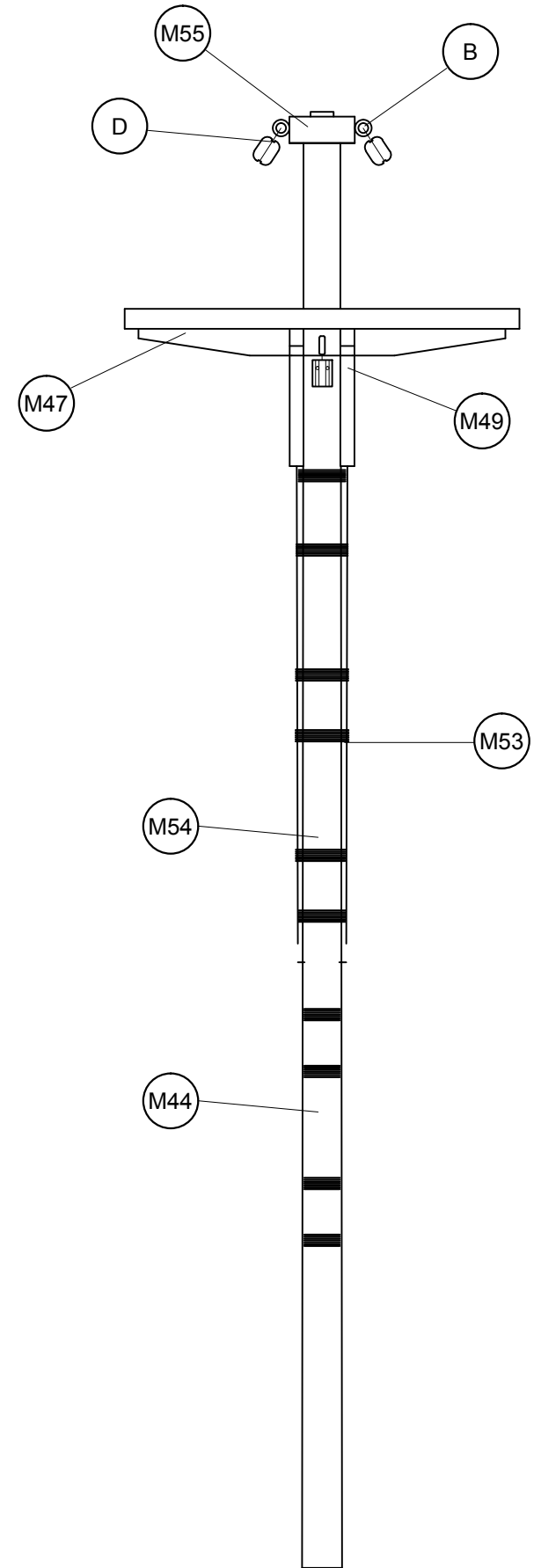
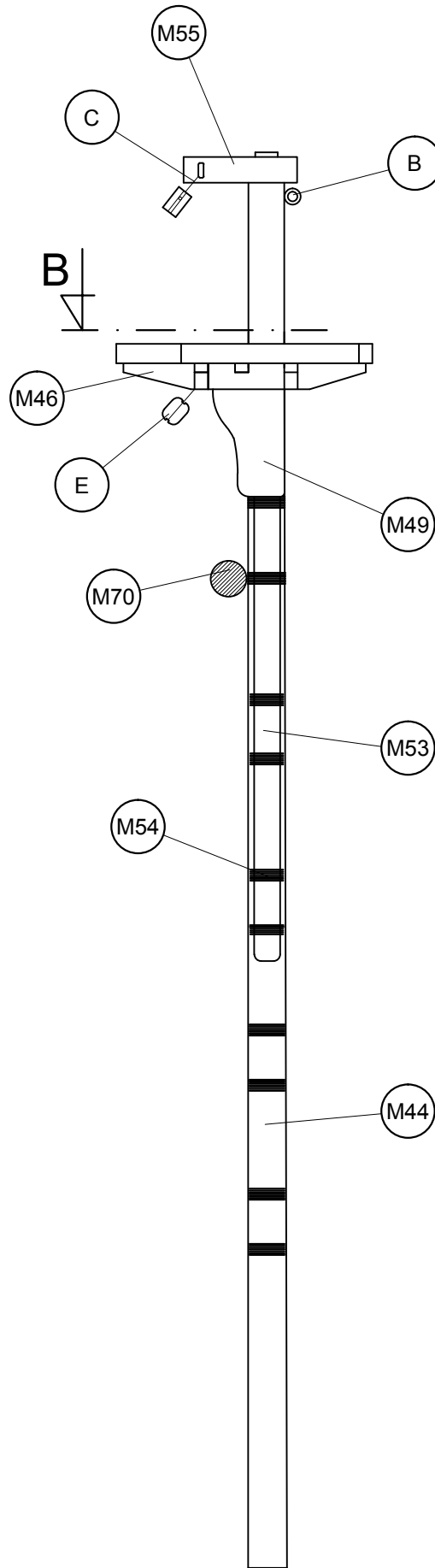
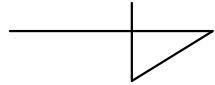

A

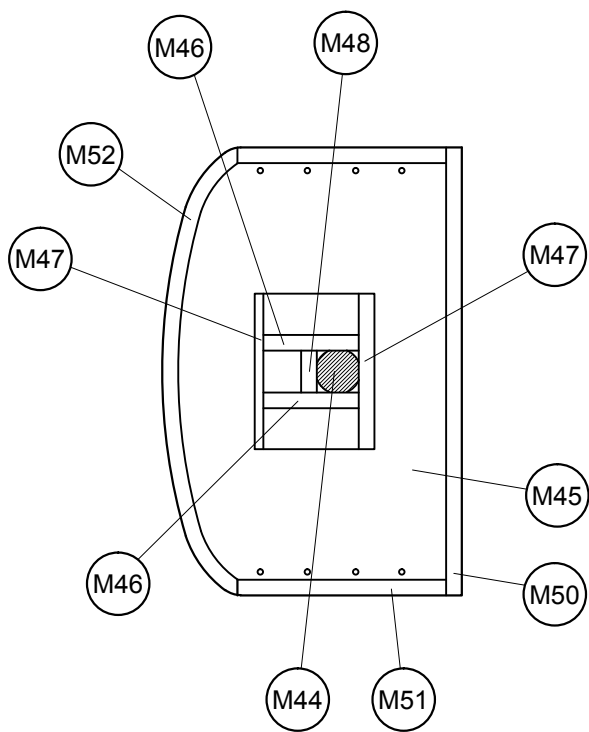

B

Scale 1/1

M44	ø6x219	Tilo / Lime wood / Tilleul / Linde / Tiglio	M52	2x3x65	Tilo / Lime wood / Tilleul / Linde / Tiglio
M45	Precortado / Precut / Prédécoupé / Vorgeschnitten / Pretagliato	Tablero / Plywood / Planche / Sperrholz / Tavola	M53	1x4x69	Tilo / Lime wood / Tilleul / Linde / Tiglio
M46	Precortado / Precut / Prédécoupé / Vorgeschnitten / Pretagliato	Tablero / Plywood / Planche / Sperrholz / Tavola	M54	ø0,50x100	Hilo marrón / Brown thread / Fil brun / braunes Baumwollfaden / Filo marrone
M47	Precortado / Precut / Prédécoupé / Vorgeschnitten / Pretagliato	Tablero / Plywood / Planche / Sperrholz / Tavola	M55	Precortado / Precut / Prédécoupé / Vorgeschnitten / Pretagliato	Tablero / Plywood / Planche / Sperrholz / Tavola
M48	Precortado / Precut / Prédécoupé / Vorgeschnitten / Pretagliato	Tablero / Plywood / Planche / Sperrholz / Tavola	B	15	Latón / Brass / Laiton / Messing / Ottone
M49	Precortado / Precut / Prédécoupé / Vorgeschnitten / Pretagliato	Tablero / Plywood / Planche / Sperrholz / Tavola	C	ø0,15x100	Hilo crudo / Raw thread / Fil brut / Rohes Baumwollfaden / Filo crudo
M50	2x3x60	Tilo / Lime wood / Tilleul / Linde / Tiglio	D	4	Composite / Composite / Composite / Composite / Composite
M51	2x3x28	Tilo / Lime wood / Tilleul / Linde / Tiglio	E	4	Composite / Composite / Composite / Composite / Composite

Terror

Model based on the plans of Matthew Betts

OcCre
Ocio Creativo

Palo mayor / Main mast / Grand mât
Hauptmast / Albero maestro

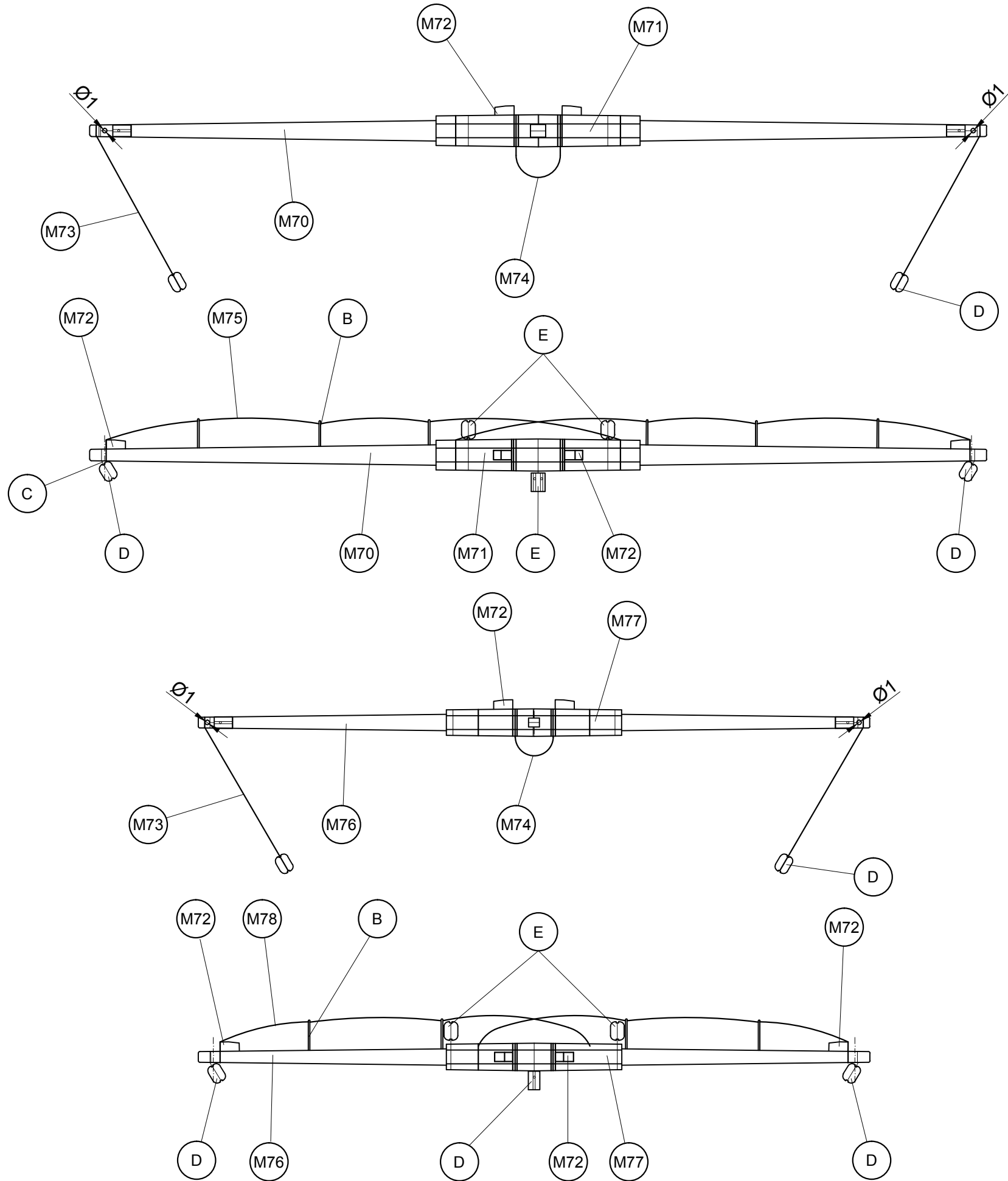

Scale 1/1

M70	ø5x195	Tilo / Lime wood / Tilleul / Linde / Tiglio	M77	1x3x38	Tilo / Lime wood / Tilleul / Linde / Tiglio
M71	1x3x44	Tilo / Lime wood / Tilleul / Linde / Tiglio	M78	ø0,50x130	Hilo marrón / Brown thread / Fil brun /braunes Baumwollfaden / Filo marrone
M72	2x2x4	Tilo / Lime wood / Tilleul / Linde / Tiglio	B	15	Latón / Brass / Laiton / Messing
M73	ø0,50x75	Hilo marrón / Brown thread / Fil brun /braunes Baumwollfaden / Filo marrone	C	ø0,15x100	Hilo crudo / Raw thread / Fil brut / Rohes Baumwollfaden / Filo crudo
M74	ø0,50x100	Hilo marrón / Brown thread / Fil brun /braunes Baumwollfaden / Filo marrone	D	4	Composite / Composite / Composite / Composite / Composite
M75	ø0,50x165	Hilo marrón / Brown thread / Fil brun /braunes Baumwollfaden / Filo marrone	E	4	Composite / Composite / Composite / Composite / Composite
M76	ø4x146	Tilo / Lime wood / Tilleul / Linde / Tiglio			

Terror

Model based on the plans of Matthew Betts

OcCre
Ocio Creativo

Palo mayor / Main mast / Grand mât
Hauptmast / Albero maestro

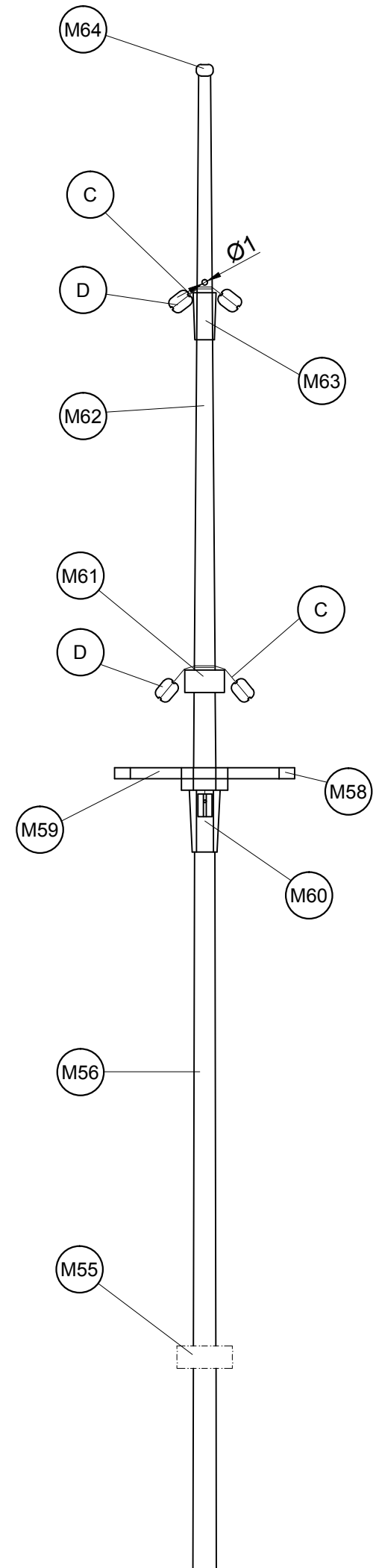
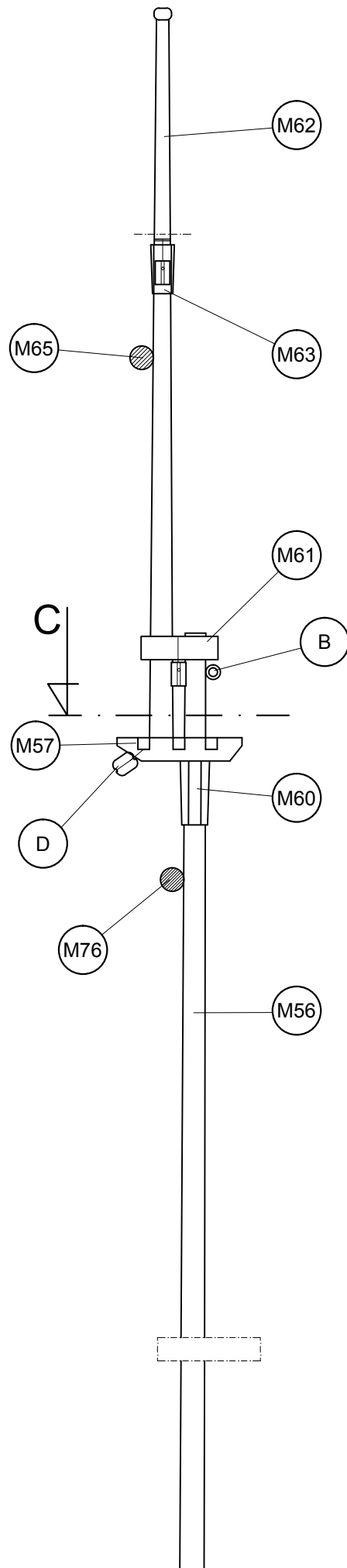
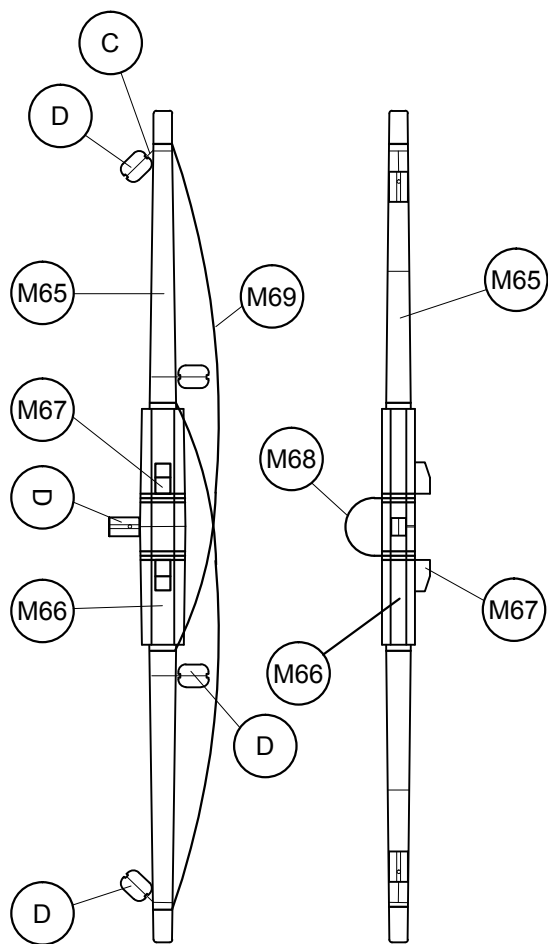
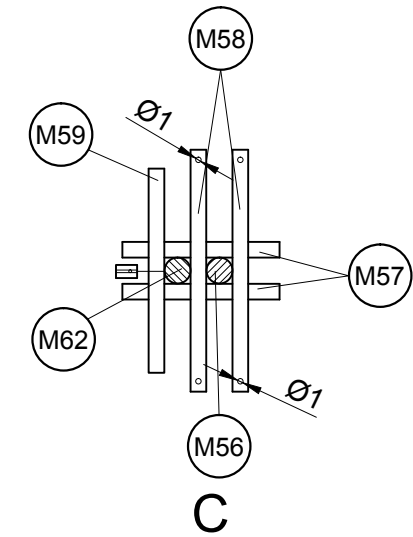

Scale 1/1

M56	ø5x160	Tilo / Lime wood / Tilleul / Linde / Tiglio	M65	ø3x110	Tilo / Lime wood / Tilleul / Linde / Tiglio
M57	Precortado / Precut / Prédécoupé / Vorgeschnitten / Pretagliato	Tablero / Plywood / Planche / Sperrholz / Tavola	M66	1x3x31	Tilo / Lime wood / Tilleul / Linde / Tiglio
M58	2x2x32	Tilo / Lime wood / Tilleul / Linde / Tiglio	M67	2x2x5	Tilo / Lime wood / Tilleul / Linde / Tiglio
M59	2x2x27	Tilo / Lime wood / Tilleul / Linde / Tiglio	M68	ø0,50x100	Hilo marrón / Brown thread / Fil brun /braunes Baumwollfaden / Filo marrone
M60	1x3x11	Tilo / Lime wood / Tilleul / Linde / Tiglio	M69	ø0,50x115	Hilo marrón / Brown thread / Fil brun /braunes Baumwollfaden / Filo marrone
M61	Precortado / Precut / Prédécoupé / Vorgeschnitten / Pretagliato	Tablero / Plywood / Planche / Sperrholz / Tavola	B	15	Latón / Brass / Laiton / Messing / Ottone
M62	ø4x128	Tilo / Lime wood / Tilleul / Linde / Tiglio	C	ø0,15x100	Hilo crudo / Raw thread / Fil brut / Rohes Baumwollfaden / Filo crudo
M63	1x3x10	Tilo / Lime wood / Tilleul / Linde / Tiglio	D	4	Composite / Composite / Composite / Composite / Composite
M64	ø3	Cristal / Crystal / Crystal / Kristall / Cristallo	E	4	Composite / Composite / Composite / Composite / Composite

Terror

Model based on the plans of Matthew Betts

OcCre
Ocio Creativo

Palo mesana / Mizze mast
Mât d'artimon / Besanmast
Albero mezzana

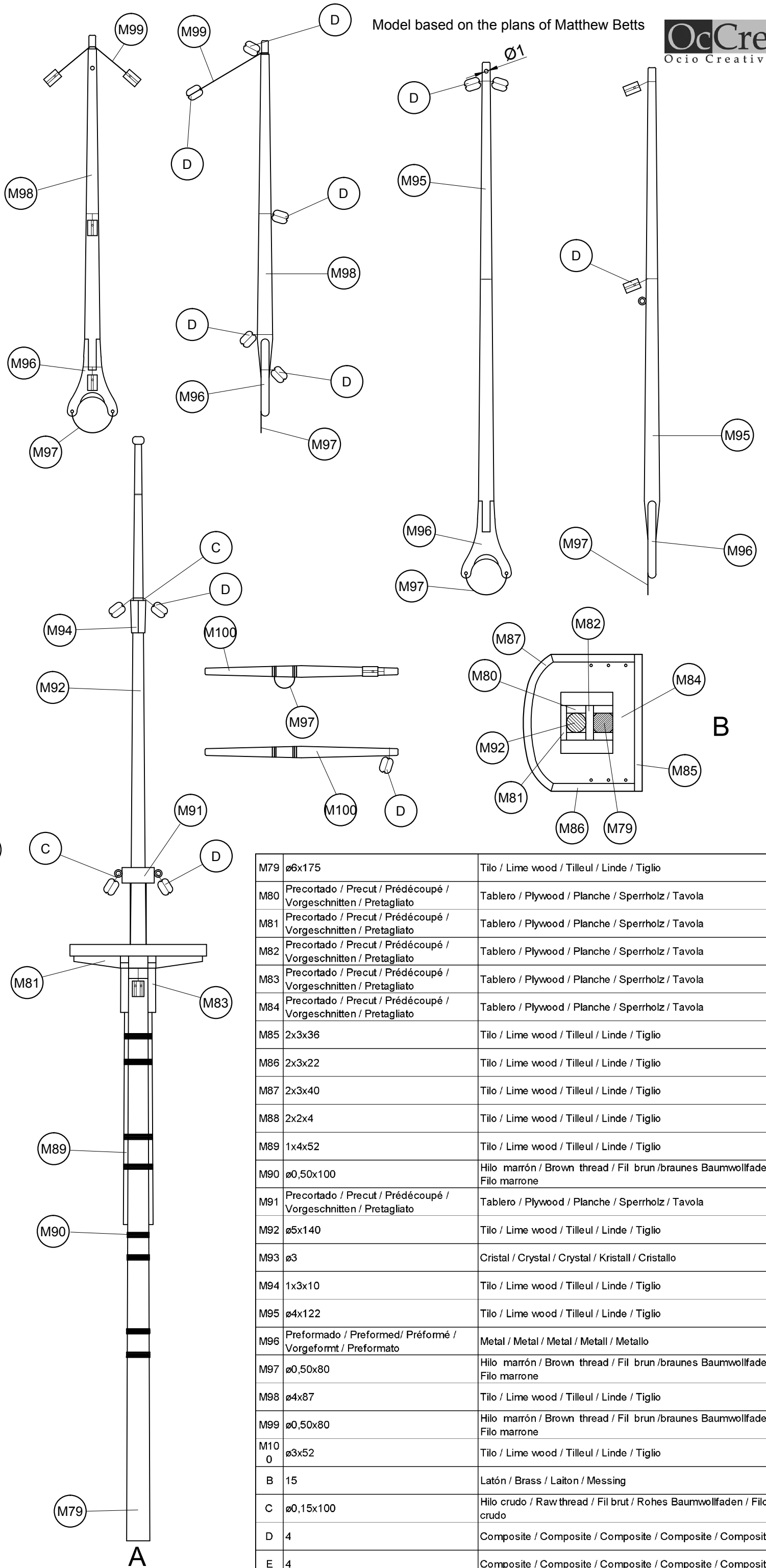
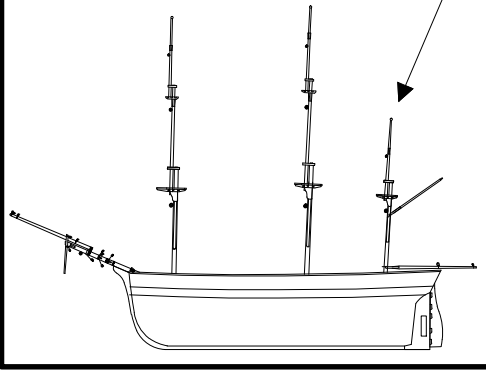

M79	ø6x175	Tilo / Lime wood / Tilleul / Linde / Tiglio
M80	Precortado / Precut / Prédécoupé / Vorgeschnitten / Pretagliato	Tablero / Plywood / Planche / Sperrholz / Tavola
M81	Precortado / Precut / Prédécoupé / Vorgeschnitten / Pretagliato	Tablero / Plywood / Planche / Sperrholz / Tavola
M82	Precortado / Precut / Prédécoupé / Vorgeschnitten / Pretagliato	Tablero / Plywood / Planche / Sperrholz / Tavola
M83	Precortado / Precut / Prédécoupé / Vorgeschnitten / Pretagliato	Tablero / Plywood / Planche / Sperrholz / Tavola
M84	Precortado / Precut / Prédécoupé / Vorgeschnitten / Pretagliato	Tablero / Plywood / Planche / Sperrholz / Tavola
M85	2x3x36	Tilo / Lime wood / Tilleul / Linde / Tiglio
M86	2x3x22	Tilo / Lime wood / Tilleul / Linde / Tiglio
M87	2x3x40	Tilo / Lime wood / Tilleul / Linde / Tiglio
M88	2x2x4	Tilo / Lime wood / Tilleul / Linde / Tiglio
M89	1x4x52	Tilo / Lime wood / Tilleul / Linde / Tiglio
M90	ø0,50x100	Hilo marrón / Brown thread / Fil brun /braunes Baumwollfaden / Filo marrone
M91	Precortado / Precut / Prédécoupé / Vorgeschnitten / Pretagliato	Tablero / Plywood / Planche / Sperrholz / Tavola
M92	ø5x140	Tilo / Lime wood / Tilleul / Linde / Tiglio
M93	ø3	Cristal / Crystal / Crystal / Kristall / Cristallo
M94	1x3x10	Tilo / Lime wood / Tilleul / Linde / Tiglio
M95	ø4x122	Tilo / Lime wood / Tilleul / Linde / Tiglio
M96	Preformado / Preformed / Préformé / Vorgeformt / Preformato	Metal / Metal / Metal / Metall / Metallo
M97	ø0,50x80	Hilo marrón / Brown thread / Fil brun /braunes Baumwollfaden / Filo marrone
M98	ø4x87	Tilo / Lime wood / Tilleul / Linde / Tiglio
M99	ø0,50x80	Hilo marrón / Brown thread / Fil brun /braunes Baumwollfaden / Filo marrone
M100	ø3x52	Tilo / Lime wood / Tilleul / Linde / Tiglio
B	15	Latón / Brass / Laiton / Messing
C	ø0,15x100	Hilo crudo / Raw thread / Fil brut / Rohes Baumwollfaden / Filo crudo
D	4	Composite / Composite / Composite / Composite / Composite
E	4	Composite / Composite / Composite / Composite / Composite

Scale 1/1

Terror

A

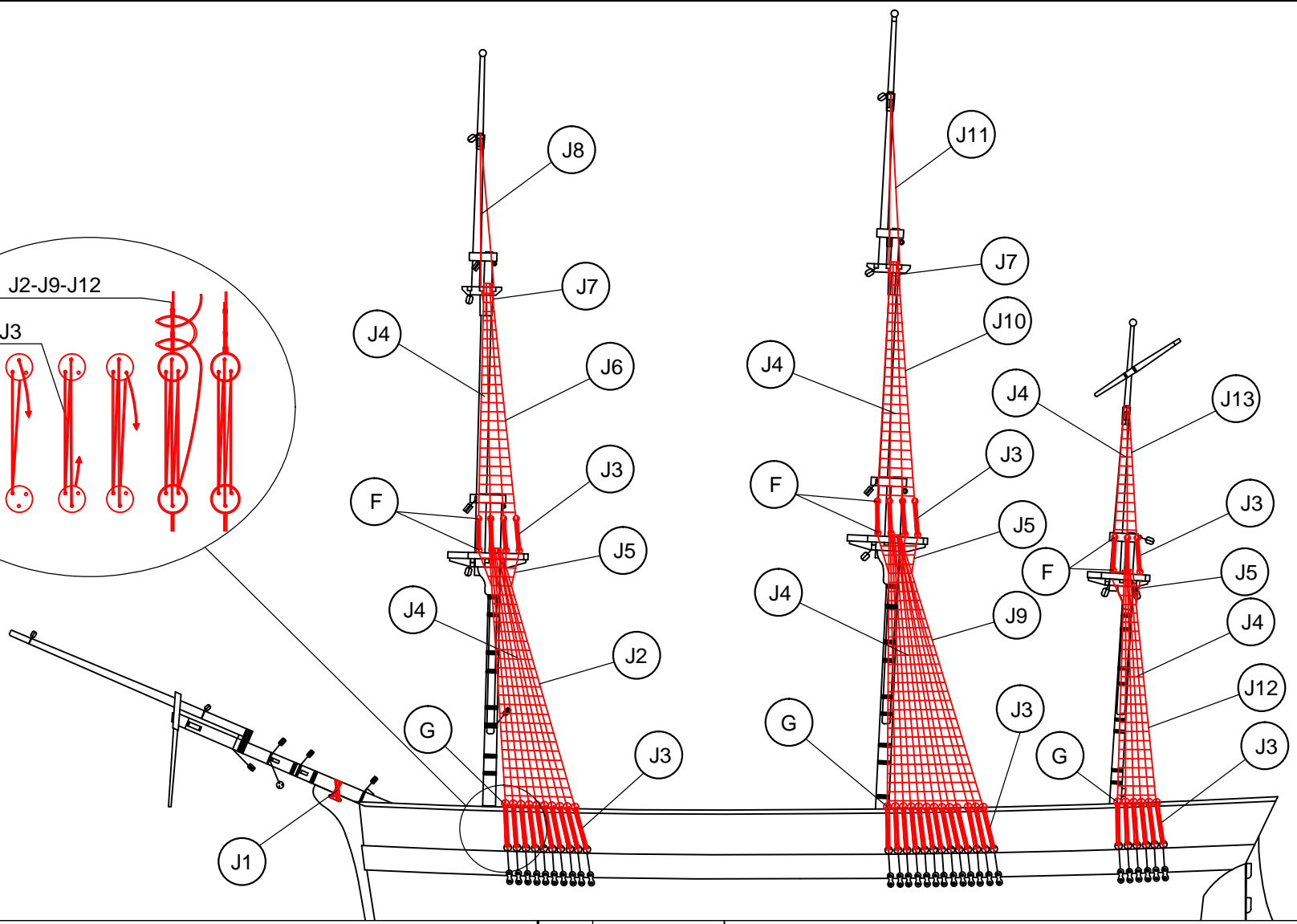
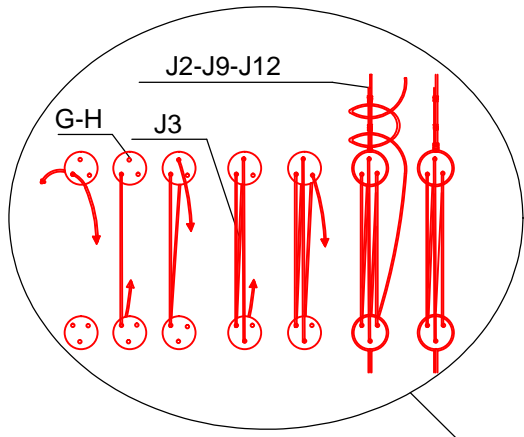

J1	∅0,50x200	Hilo marrón / Brown thread / Fil brun /braunes Baumwollfaden / Filo marrone	J9	∅0,50x410	Hilo marrón / Brown thread / Fil brun /braunes Baumwollfaden / Filo marrone
J2	∅0,50x350	Hilo marrón / Brown thread / Fil brun /braunes Baumwollfaden / Filo marrone	J10	∅0,50x325	Hilo marrón / Brown thread / Fil brun /braunes Baumwollfaden / Filo marrone
J3	∅0,15x175	Hilo algodón crudo / Raw cotton thread / Fil coton brut / Rohes Baumwollfaden	J11	∅0,50x230	Hilo marrón / Brown thread / Fil brun /braunes Baumwollfaden / Filo marrone
J4	∅0,15x110	Hilo marrón / Brown thread / Fil brun /braunes Baumwollfaden / Filo marrone	J12	∅0,50x300	Hilo marrón / Brown thread / Fil brun /braunes Baumwollfaden / Filo marrone
J5	∅0,50x90	Hilo marrón / Brown thread / Fil brun /braunes Baumwollfaden / Filo marrone	J13	∅0,50x225	Hilo marrón / Brown thread / Fil brun /braunes Baumwollfaden / Filo marrone
J6	∅0,50x350	Hilo marrón / Brown thread / Fil brun /braunes Baumwollfaden / Filo marrone	F	∅4	Composite / Composite / Composite / Composite / Composite
J7	∅0,50x80	Hilo marrón / Brown thread / Fil brun /braunes Baumwollfaden / Filo marrone	G	∅5	Composite / Composite / Composite / Composite / Composite
J8	∅0,50x215	Hilo marrón / Brown thread / Fil brun /braunes Baumwollfaden / Filo marrone			

OcCre
www.occre.com

Model based on the plans of Matthew Betts

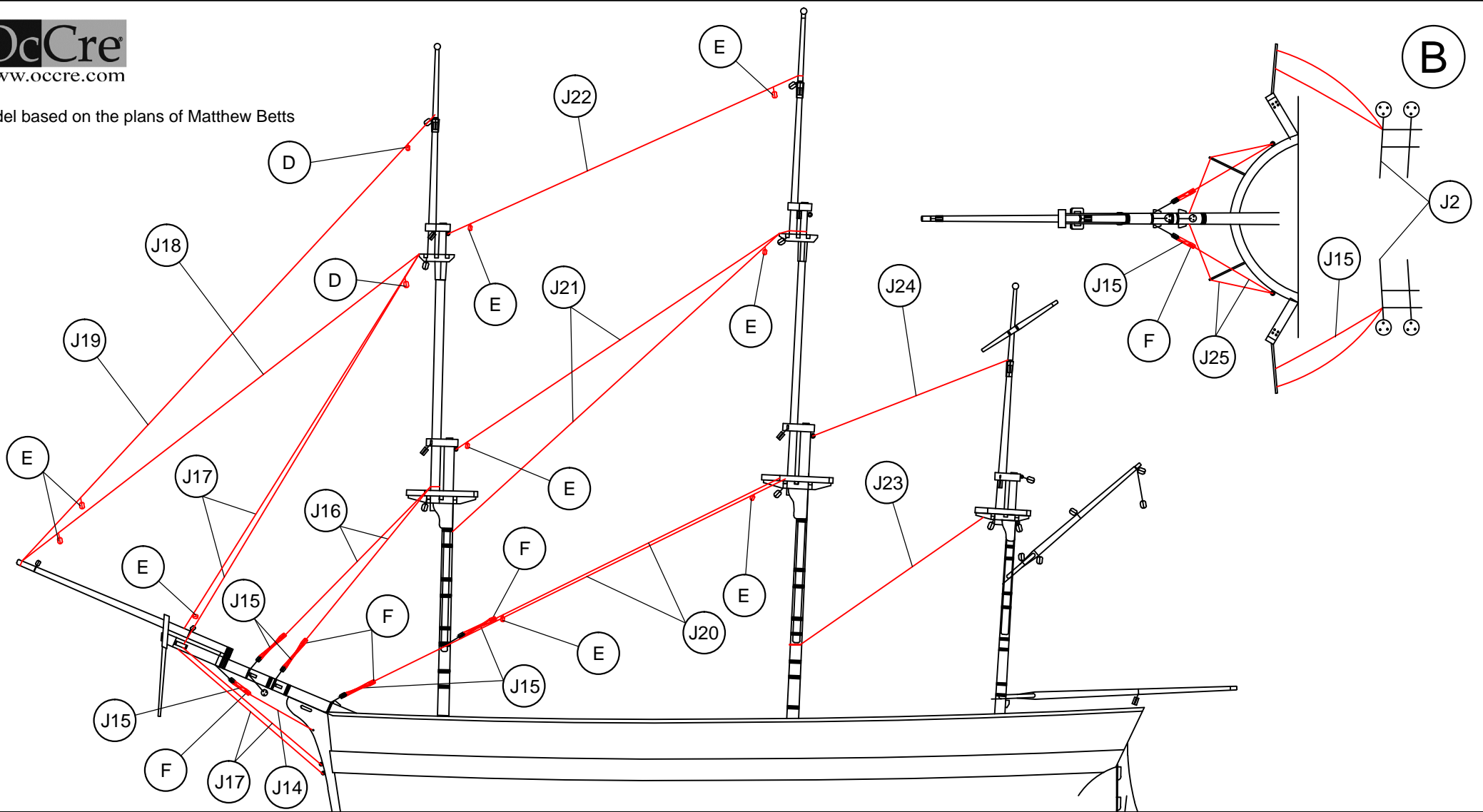

J14	∅0,50x125	Hilo marrón / Brown thread / Fil brun / braunes Baumwollfaden / Filo marrone	J22	∅0,50x300	Hilo marrón / Brown thread / Fil brun / braunes Baumwollfaden / Filo marrone
J15	∅0,15x200	Hilo crudo / Raw thread / Fil brut / Rohes Baumwollfaden / Filo crudo	J23	∅0,50x190	Hilo marrón / Brown thread / Fil brun / braunes Baumwollfaden / Filo marrone
J16	∅0,50x300	Hilo marrón / Brown thread / Fil brun / braunes Baumwollfaden / Filo marrone	J24	∅0,50x225	Hilo marrón / Brown thread / Fil brun / braunes Baumwollfaden / Filo marrone
J17	∅0,50x400	Hilo marrón / Brown thread / Fil brun / braunes Baumwollfaden / Filo marrone	J25	∅0,50x125	Hilo marrón / Brown thread / Fil brun / braunes Baumwollfaden / Filo marrone
J18	∅0,50x285	Hilo marrón / Brown thread / Fil brun / braunes Baumwollfaden / Filo marrone	D	4	Composite / Composite / Composite / Composite / Composite
J19	∅0,50x375	Hilo marrón / Brown thread / Fil brun / braunes Baumwollfaden / Filo marrone	E	4	Composite / Composite / Composite / Composite / Composite
J20	∅0,50x595	Hilo marrón / Brown thread / Fil brun / braunes Baumwollfaden / Filo marrone	F	∅4	Composite / Composite / Composite / Composite / Composite
J21	∅0,50x560	Hilo marrón / Brown thread / Fil brun / braunes Baumwollfaden / Filo marrone			

Terror

OcCre
www.occre.com

Model based on the plans of Matthew Betts

C

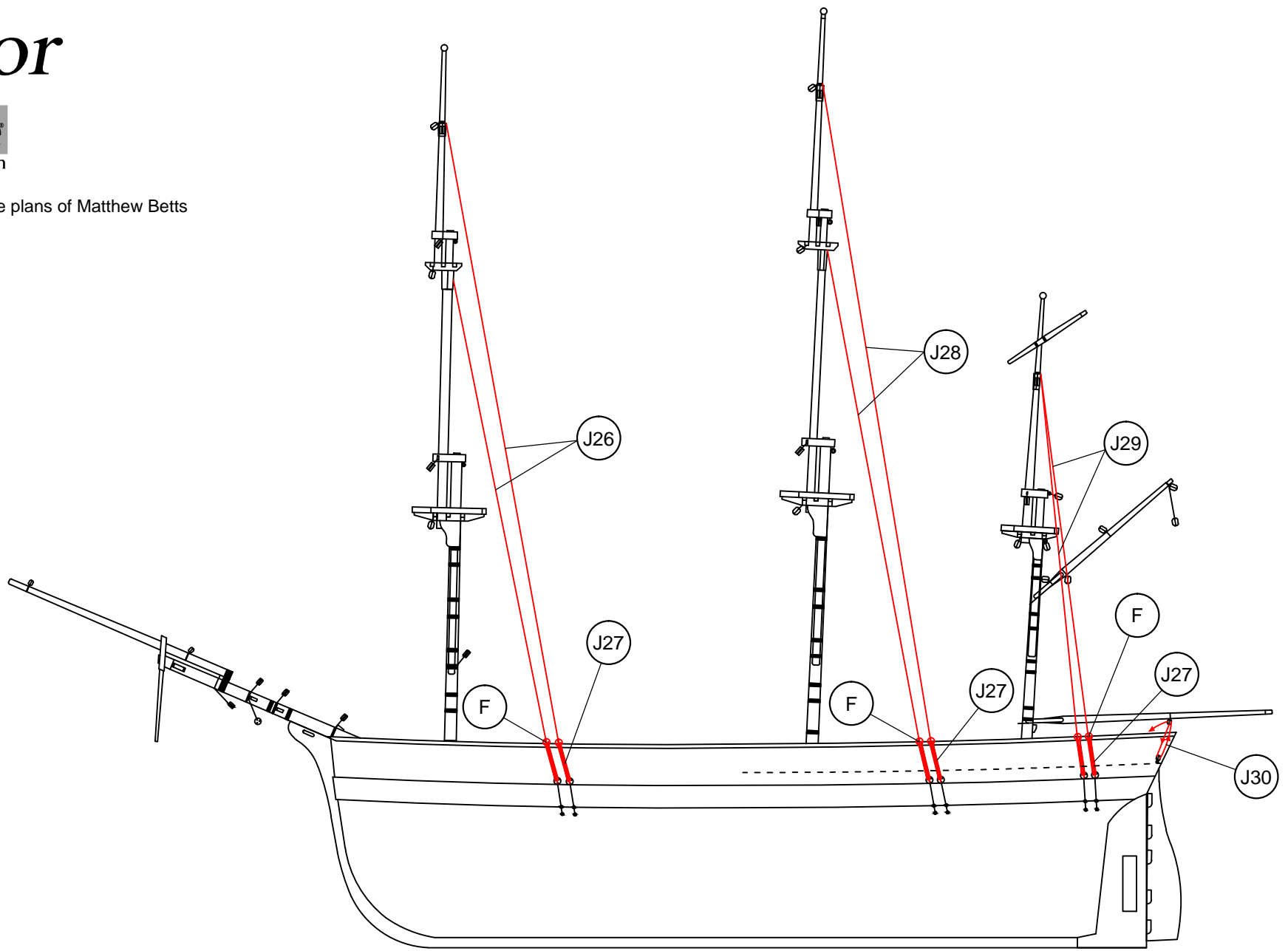

J26	∅0,50x750	Hilo marrón / Brown thread / Fil brun /braunes Baumwollfaden / Filo marrone	J29	∅0,50x625	Hilo marrón / Brown thread / Fil brun /braunes Baumwollfaden / Filo marrone
J27	∅0,15x200	Hilo crudo / Raw thread / Fil brut / Rohes Baumwollfaden / Filo crudo	J30	∅0,15x200	Hilo crudo / Raw thread / Fil brut / Rohes Baumwollfaden / Filo crudo
J28	∅0,50x850	Hilo marrón / Brown thread / Fil brun /braunes Baumwollfaden / Filo marrone	F	4	Composite / Composite / Composite / Composite / Composite

D

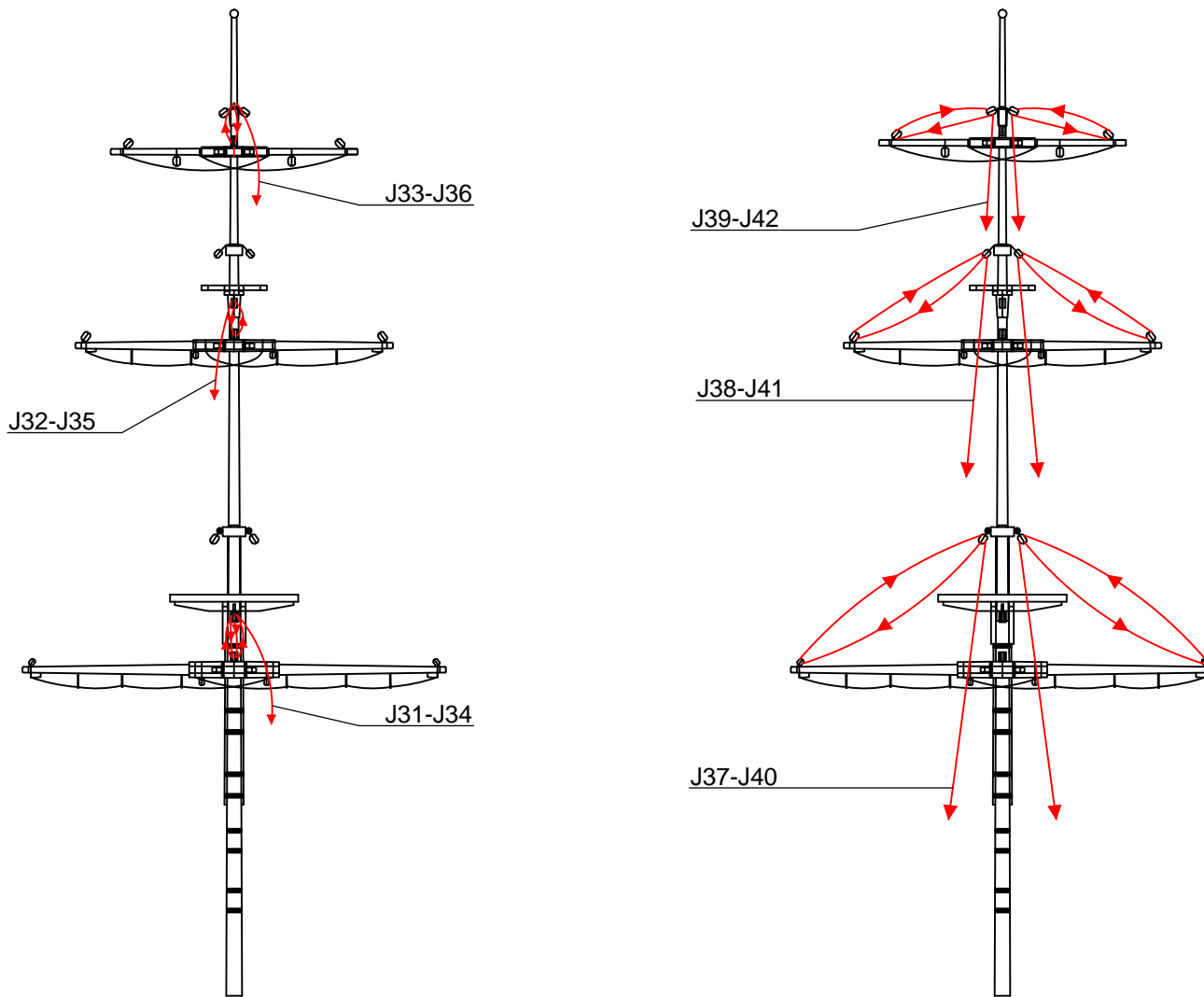

J31	∅0,15x250	Hilo crudo / Raw thread / Fil brut / Rohes Baumwollfaden / Filo crudo	J37	∅0,15x475	Hilo crudo / Raw thread / Fil brut / Rohes Baumwollfaden / Filo crudo
J32	∅0,15x350	Hilo crudo / Raw thread / Fil brut / Rohes Baumwollfaden / Filo crudo	J38	∅0,15x450	Hilo crudo / Raw thread / Fil brut / Rohes Baumwollfaden / Filo crudo
J33	∅0,15x450	Hilo crudo / Raw thread / Fil brut / Rohes Baumwollfaden / Filo crudo	J39	∅0,15x425	Hilo crudo / Raw thread / Fil brut / Rohes Baumwollfaden / Filo crudo
J34	∅0,15x300	Hilo crudo / Raw thread / Fil brut / Rohes Baumwollfaden / Filo crudo	J40	∅0,15x500	Hilo crudo / Raw thread / Fil brut / Rohes Baumwollfaden / Filo crudo
J35	∅0,15x425	Hilo crudo / Raw thread / Fil brut / Rohes Baumwollfaden / Filo crudo	J41	∅0,15x480	Hilo crudo / Raw thread / Fil brut / Rohes Baumwollfaden / Filo crudo
J36	∅0,15x600	Hilo crudo / Raw thread / Fil brut / Rohes Baumwollfaden / Filo crudo	J42	∅0,15x550	Hilo crudo / Raw thread / Fil brut / Rohes Baumwollfaden / Filo crudo

Terror

Aparejo de velas / Sail rig / Gréement
Segel takelage / Sartiamе da vela

E

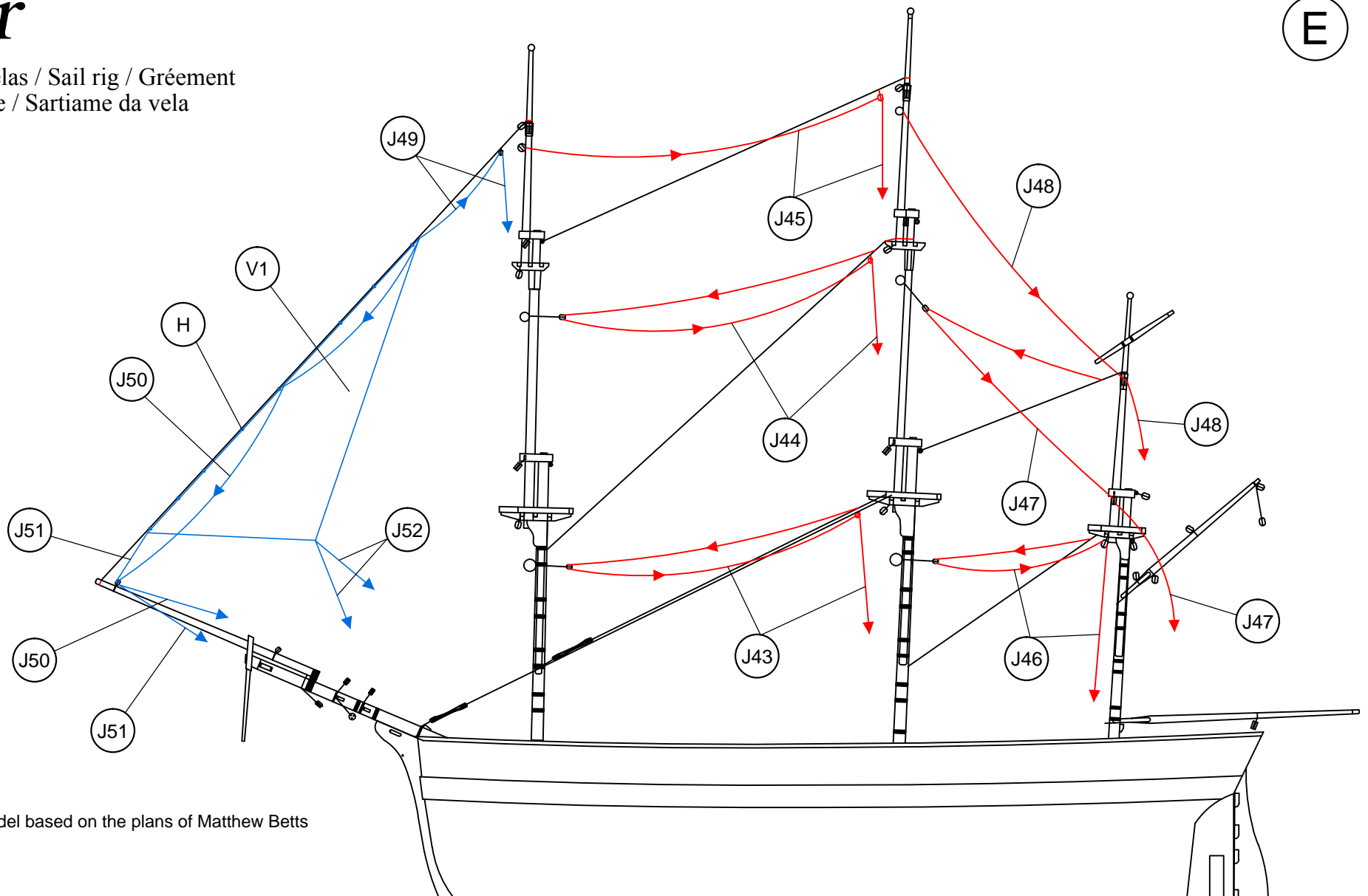

OcCre

www.occre.com Model based on the plans of Matthew Betts

J43	∅0,15x750	Hilo crudo / Raw thread / Fil brut / Rohes Baumwollfaden / Filo crudo	V1	Preformado / Preformed/ Préformé / Vorgeformt / Preformato	Tela / Cloth / Étoffe / Stoff / Tela
J44	∅0,15x600	Hilo crudo / Raw thread / Fil brut / Rohes Baumwollfaden / Filo crudo	J49	∅0,15x450	Hilo crudo / Raw thread / Fil brut / Rohes Baumwollfaden / Filo crudo
J45	∅0,15x625	Hilo crudo / Raw thread / Fil brut / Rohes Baumwollfaden / Filo crudo	J50	∅0,15x500	Hilo crudo / Raw thread / Fil brut / Rohes Baumwollfaden / Filo crudo
J46	∅0,15x700	Hilo crudo / Raw thread / Fil brut / Rohes Baumwollfaden / Filo crudo	J51	∅0,15x250	Hilo crudo / Raw thread / Fil brut / Rohes Baumwollfaden / Filo crudo
J47	∅0,15x600	Hilo crudo / Raw thread / Fil brut / Rohes Baumwollfaden / Filo crudo	J52	∅0,15x315	Hilo crudo / Raw thread / Fil brut / Rohes Baumwollfaden / Filo crudo
J48	∅0,15x675	Hilo crudo / Raw thread / Fil brut / Rohes Baumwollfaden / Filo crudo	H	∅3	Latón / Brass / Laiton / Messing / Ottone

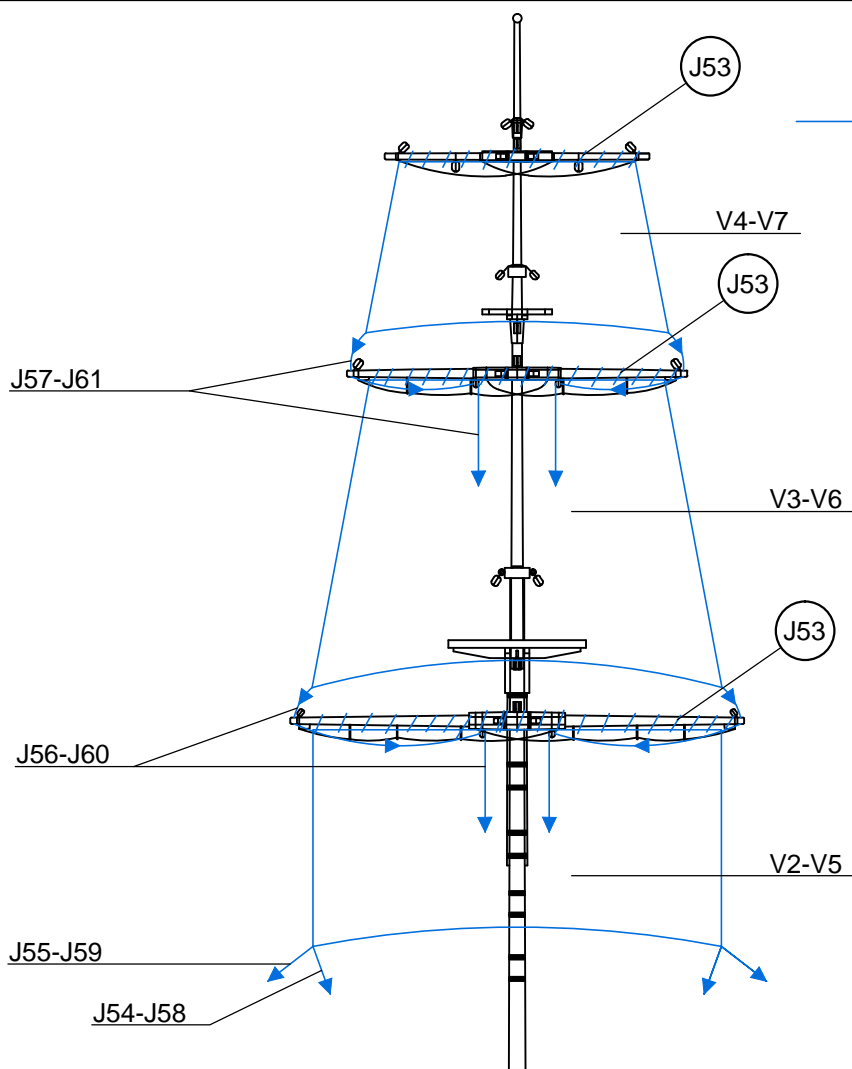

Aparejo de velas / Sail rig / Gréement
Segel takelage / Sartiamе da vela

F

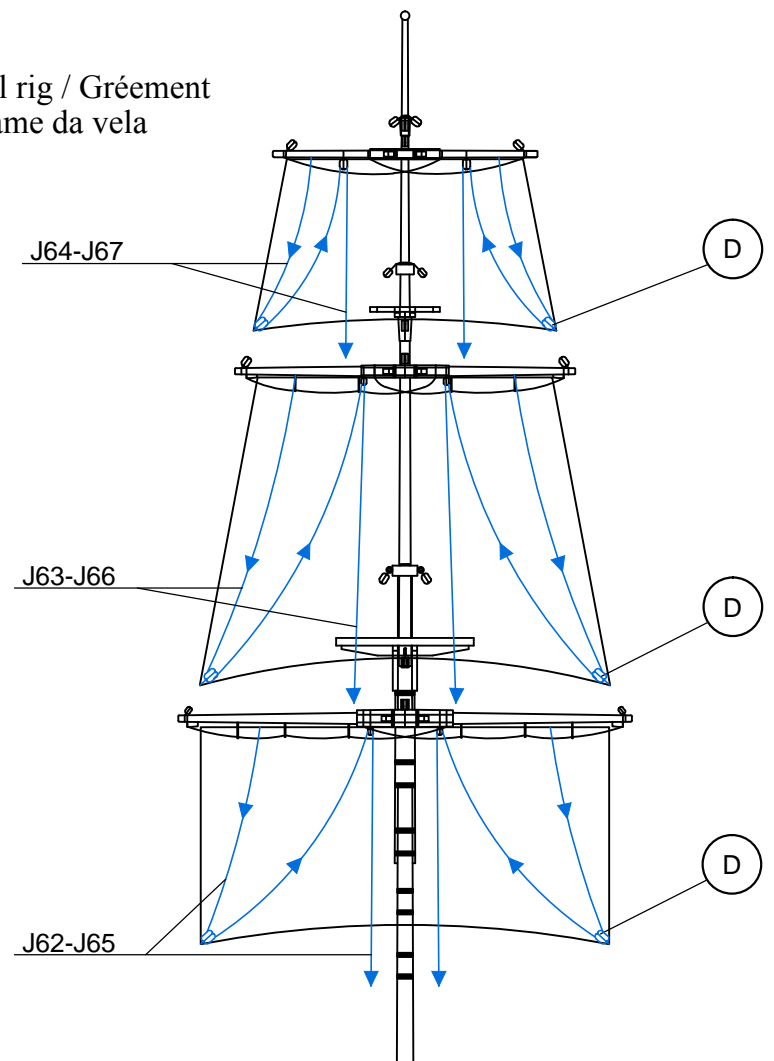

V2	Preformado / Preformed/ Préformé / Vorgeformt / Preformato	Tela / Cloth / Étoffe / Stoff / Tela	V6	Preformado / Preformed/ Préformé / Vorgeformt / Preformato	Tela / Cloth / Étoffe / Stoff / Tela
J53	∅0,15x1000	Hilo crudo / Raw thread / Fil brut / Rohes Baumwollfaden / Filo crudo	J60	∅0,15x350	Hilo crudo / Raw thread / Fil brut / Rohes Baumwollfaden / Filo crudo
J54	∅0,15x200	Hilo crudo / Raw thread / Fil brut / Rohes Baumwollfaden / Filo crudo	V7	Preformado / Preformed/ Préformé / Vorgeformt / Preformato	Tela / Cloth / Étoffe / Stoff / Tela
J55	∅0,15x200	Hilo crudo / Raw thread / Fil brut / Rohes Baumwollfaden / Filo crudo	J61	∅0,15x425	Hilo crudo / Raw thread / Fil brut / Rohes Baumwollfaden / Filo crudo
V3	Preformado / Preformed/ Préformé / Vorgeformt / Preformato	Tela / Cloth / Étoffe / Stoff / Tela	J62	∅0,15x500	Hilo crudo / Raw thread / Fil brut / Rohes Baumwollfaden / Filo crudo
J56	∅0,15x375	Hilo crudo / Raw thread / Fil brut / Rohes Baumwollfaden / Filo crudo	J63	∅0,15x650	Hilo crudo / Raw thread / Fil brut / Rohes Baumwollfaden / Filo crudo
V4	Preformado / Preformed/ Préformé / Vorgeformt / Preformato	Tela / Cloth / Étoffe / Stoff / Tela	J64	∅0,15x800	Hilo crudo / Raw thread / Fil brut / Rohes Baumwollfaden / Filo crudo
J57	∅0,15x395	Hilo crudo / Raw thread / Fil brut / Rohes Baumwollfaden / Filo crudo	J65	∅0,15x475	Hilo crudo / Raw thread / Fil brut / Rohes Baumwollfaden / Filo crudo
V5	Preformado / Preformed/ Préformé / Vorgeformt / Preformato	Tela / Cloth / Étoffe / Stoff / Tela	J66	∅0,15x575	Hilo crudo / Raw thread / Fil brut / Rohes Baumwollfaden / Filo crudo
J58	∅0,15x220	Hilo crudo / Raw thread / Fil brut / Rohes Baumwollfaden / Filo crudo	J67	∅0,15x850	Hilo crudo / Raw thread / Fil brut / Rohes Baumwollfaden / Filo crudo
J59	∅0,15x220	Hilo crudo / Raw thread / Fil brut / Rohes Baumwollfaden / Filo crudo	D	4	Composite / Composite / Composite / Composite / Composite

Terror

Aparejo de velas / Sail rig / Gréement
Segel takelage / Sartiamе da vela

G

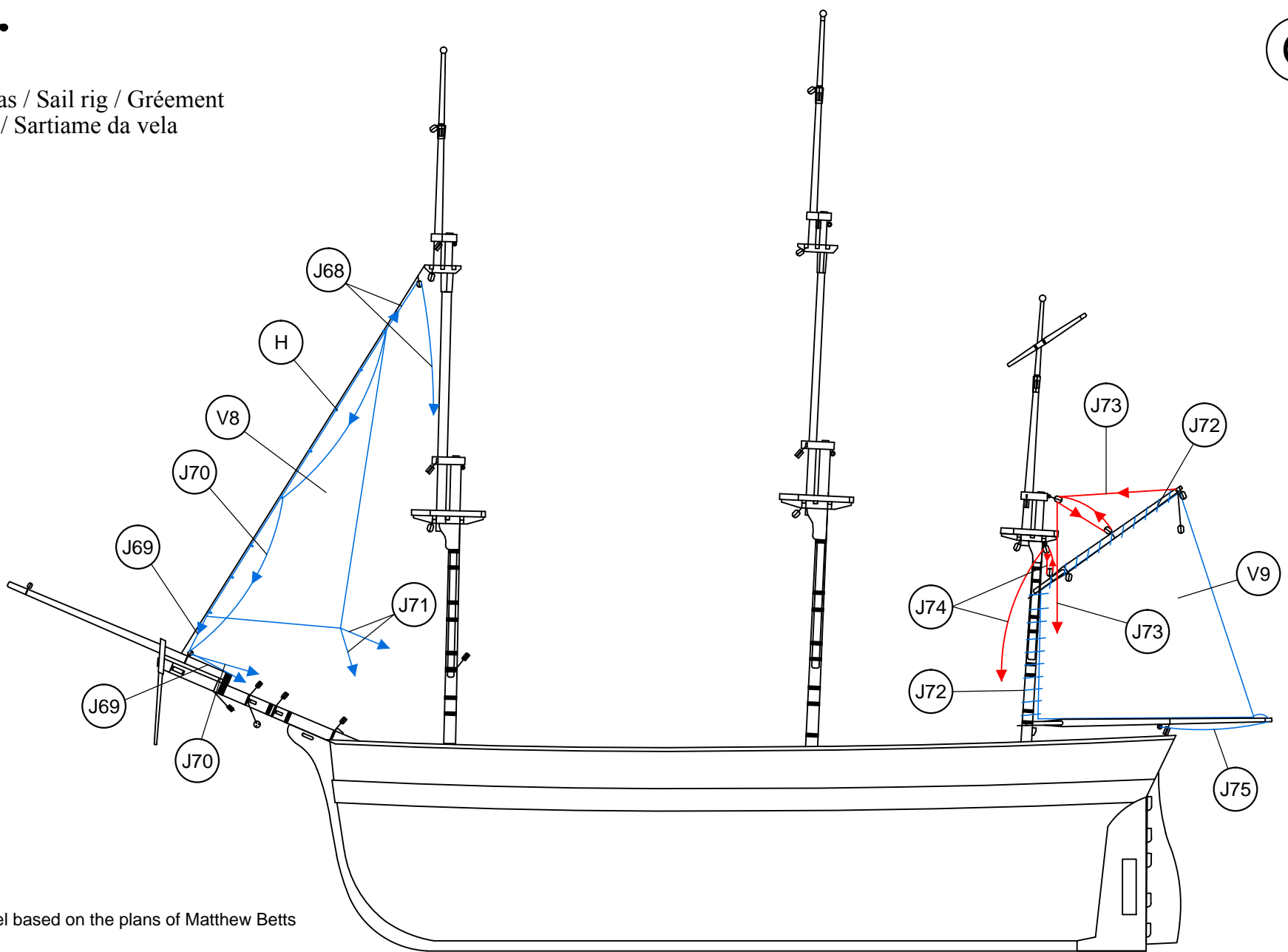

OcCre

www.occre.com

Model based on the plans of Matthew Betts

V8	Preformado / Prefomed/ Préformé / Vorgeformt / Preformato	Tela / Cloth / Étoffe / Stoff / Tela	V72	∅0,15x1000	Hilo crudo / Raw thread / Fil brut / Rohes Baumwollfaden / Filo crudo
J68	∅0,15x500	Hilo crudo / Raw thread / Fil brut / Rohes Baumwollfaden / Filo crudo	V73	∅0,15x500	Hilo crudo / Raw thread / Fil brut / Rohes Baumwollfaden / Filo crudo
J69	∅0,15x350	Hilo crudo / Raw thread / Fil brut / Rohes Baumwollfaden / Filo crudo	V74	∅0,15x400	Hilo crudo / Raw thread / Fil brut / Rohes Baumwollfaden / Filo crudo
J70	∅0,15x600	Hilo crudo / Raw thread / Fil brut / Rohes Baumwollfaden / Filo crudo	V75	∅0,15x250	Hilo crudo / Raw thread / Fil brut / Rohes Baumwollfaden / Filo crudo
J71	∅0,15x300	Hilo crudo / Raw thread / Fil brut / Rohes Baumwollfaden / Filo crudo	H	∅3	Latón / Brass / Laiton / Messing / Ottone
V9	Preformado / Prefomed/ Préformé / Vorgeformt / Preformato	Tela / Cloth / Étoffe / Stoff / Tela			

Aparejo de velas / Sail rig / Gréement
Segel takelage / Sartiamе da vela

H

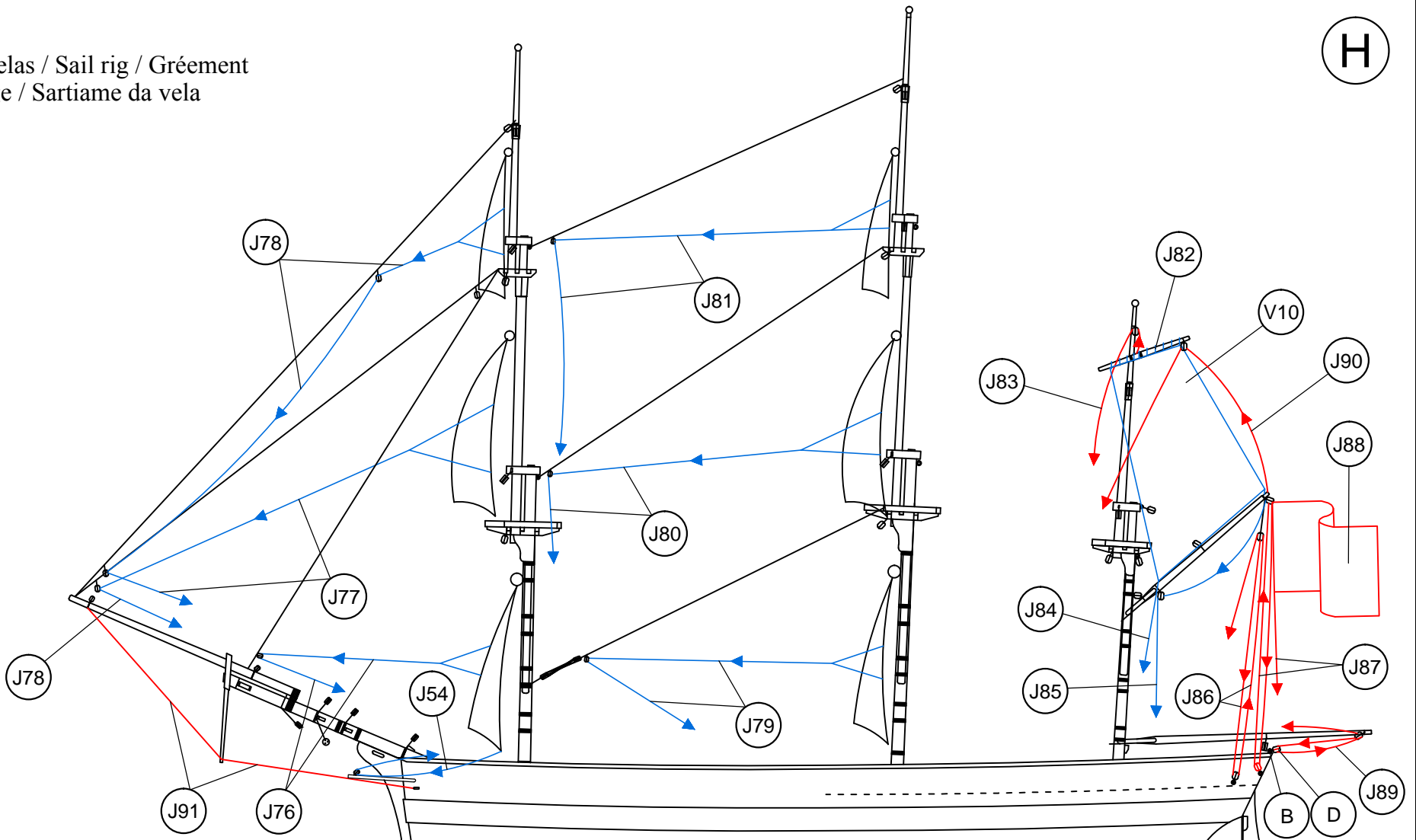

J76	∅0,15x325	Hilo crudo / Raw thread / Fil brut / Rohes Baumwollfaden / Filo crudo	J85	∅0,15x475	Hilo crudo / Raw thread / Fil brut / Rohes Baumwollfaden / Filo crudo
J77	∅0,15x520	Hilo crudo / Raw thread / Fil brut / Rohes Baumwollfaden / Filo crudo	J86	∅0,15x650	Hilo crudo / Raw thread / Fil brut / Rohes Baumwollfaden / Filo crudo
J78	∅0,15x650	Hilo crudo / Raw thread / Fil brut / Rohes Baumwollfaden / Filo crudo	J87	∅0,15x500	Hilo crudo / Raw thread / Fil brut / Rohes Baumwollfaden / Filo crudo
J79	∅0,15x420	Hilo crudo / Raw thread / Fil brut / Rohes Baumwollfaden / Filo crudo	J88	Preformado / Prefomed/ Préformé / Vorgeformt / Preformato	Tela / Cloth / Étoffe / Stoff / Tela
J80	∅0,15x500	Hilo crudo / Raw thread / Fil brut / Rohes Baumwollfaden / Filo crudo	J89	∅0,15x300	Hilo crudo / Raw thread / Fil brut / Rohes Baumwollfaden / Filo crudo
J81	∅0,15x560	Hilo crudo / Raw thread / Fil brut / Rohes Baumwollfaden / Filo crudo	J90	∅0,15x320	Hilo crudo / Raw thread / Fil brut / Rohes Baumwollfaden / Filo crudo
V10	Preformado / Prefomed/ Préformé / Vorgeformt / Preformato	Tela / Cloth / Étoffe / Stoff / Tela	J91	∅0,15x250	Hilo crudo / Raw thread / Fil brut / Rohes Baumwollfaden / Filo crudo
J82	∅0,15x1000	Hilo crudo / Raw thread / Fil brut / Rohes Baumwollfaden / Filo crudo	B	15	Latón / Brass / Laiton / Messing / Ottone
J83	∅0,15x650	Hilo crudo / Raw thread / Fil brut / Rohes Baumwollfaden / Filo crudo	D	4	Composite / Composite / Composite / Composite / Composite
J84	∅0,15x300	Hilo crudo / Raw thread / Fil brut / Rohes Baumwollfaden / Filo crudo			

Terror

Aparejo de velas / Sail rig / Gréement
Segel takelage / Sartiamе da vela

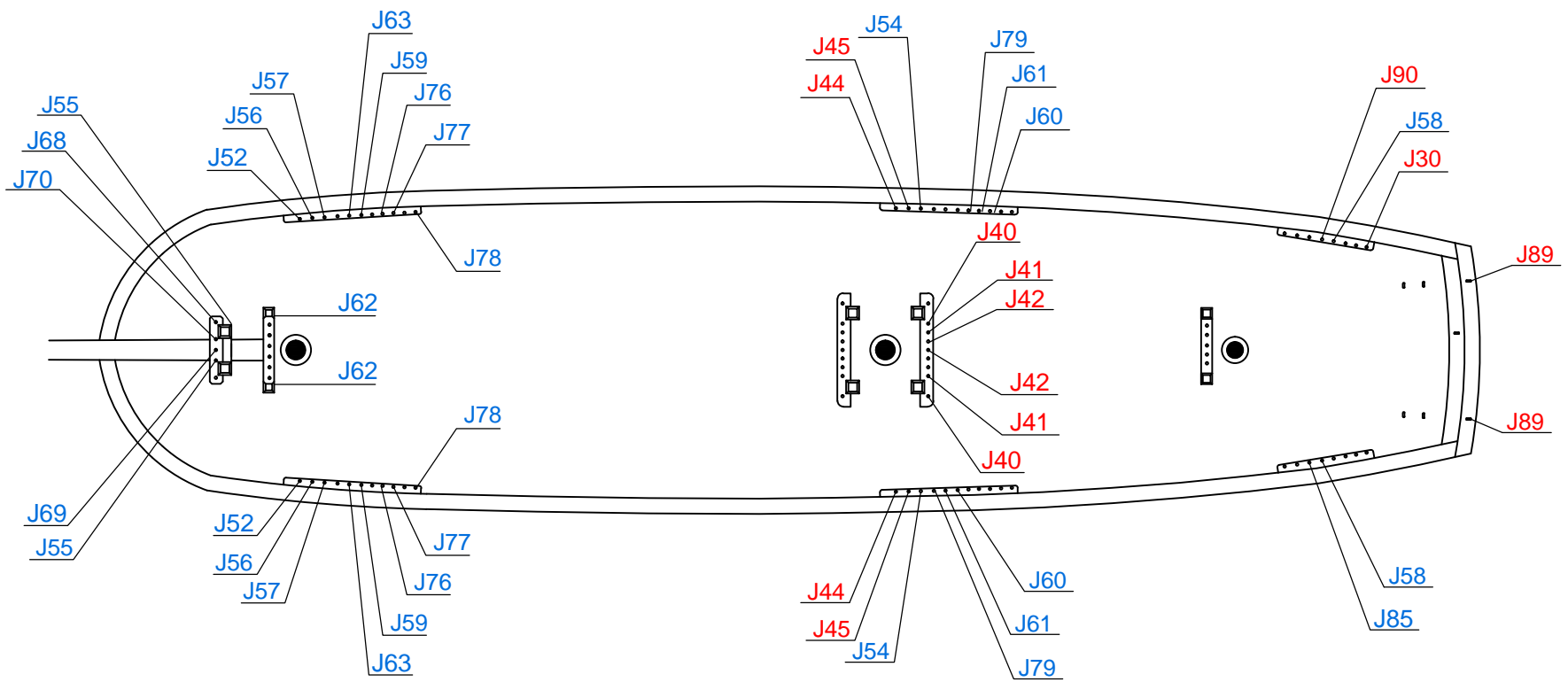
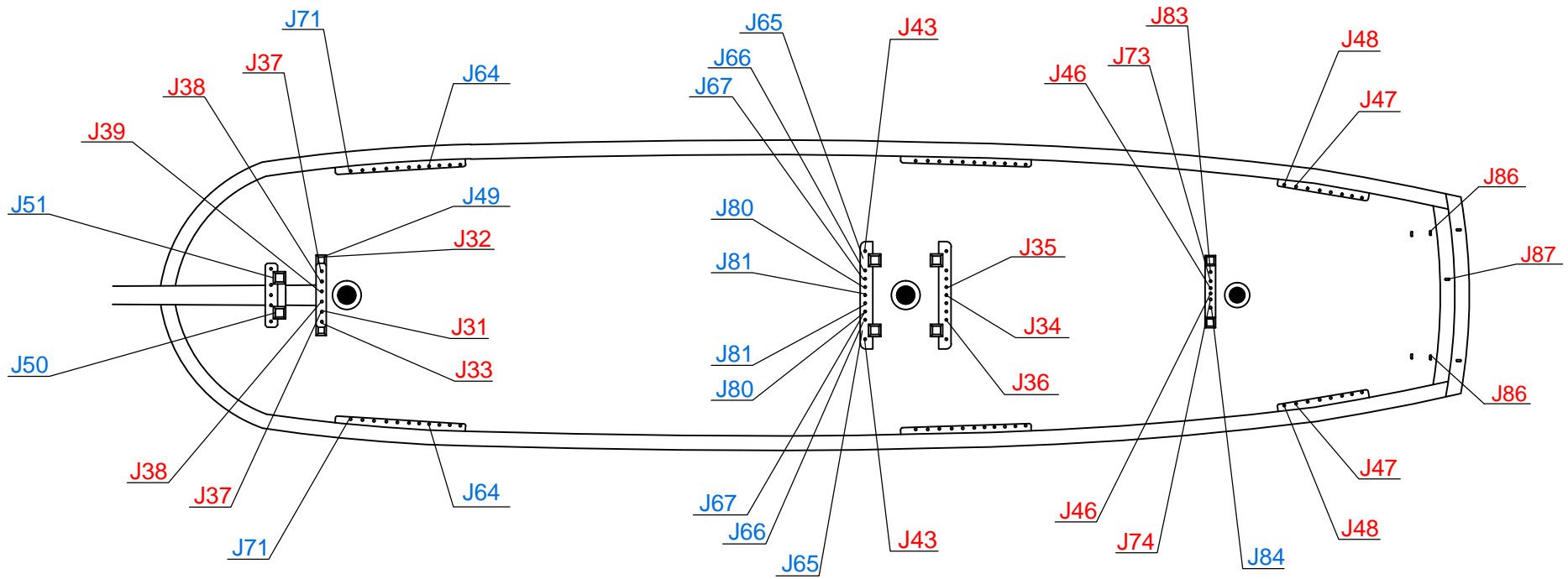

Terror

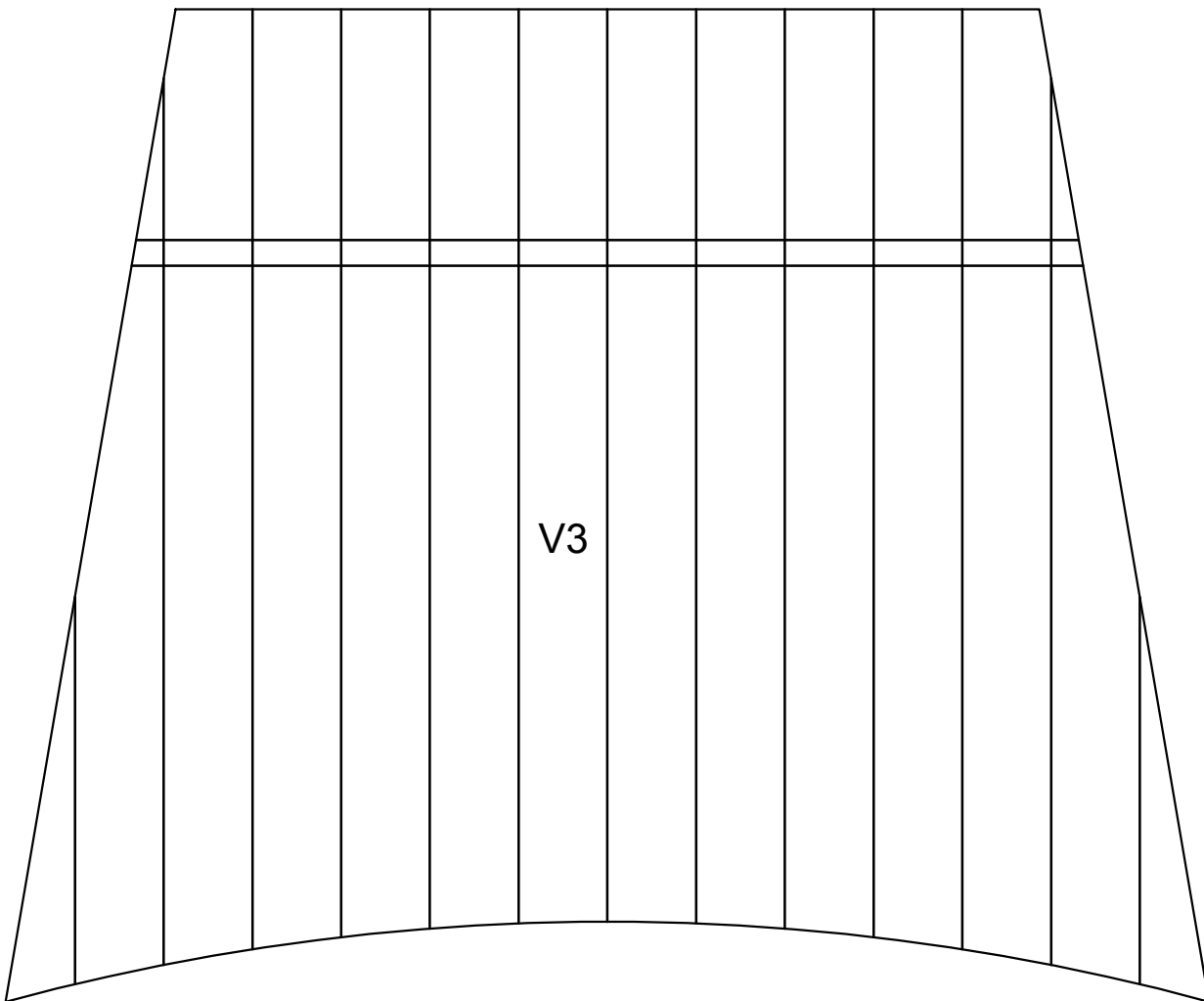
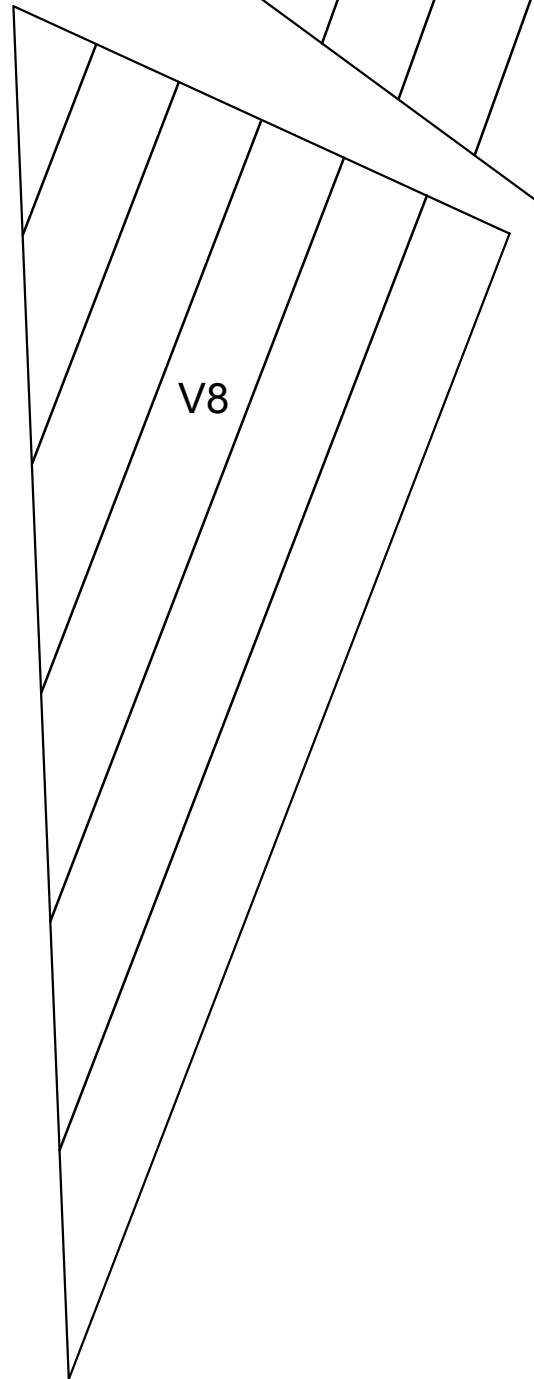
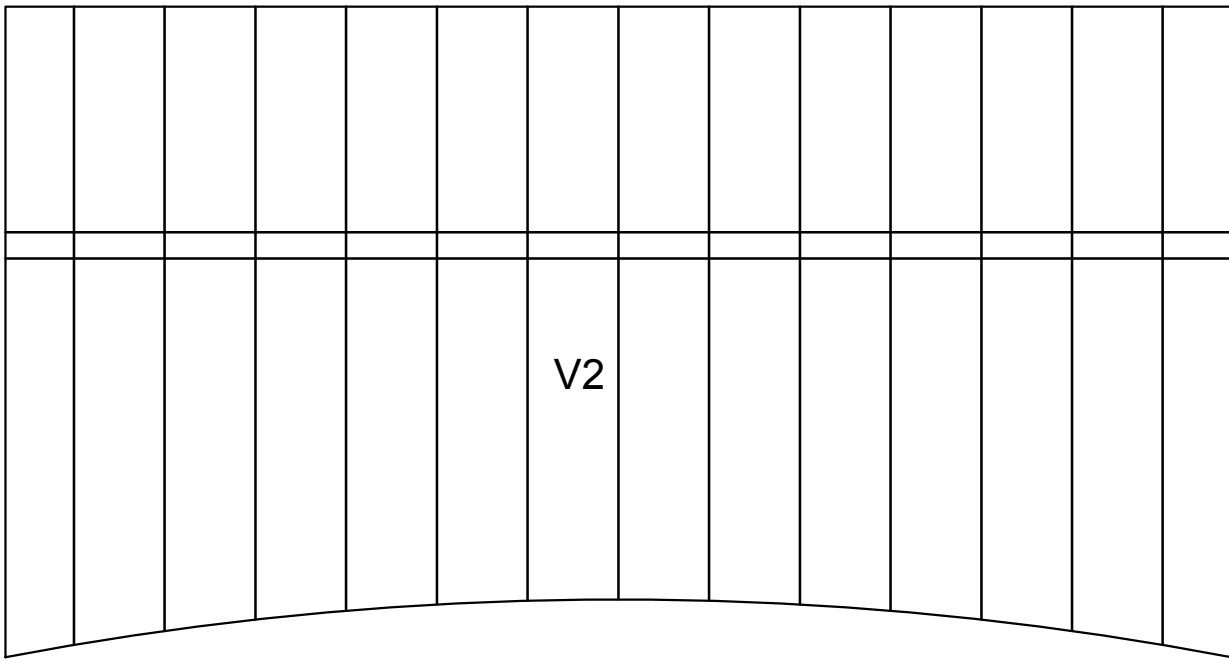
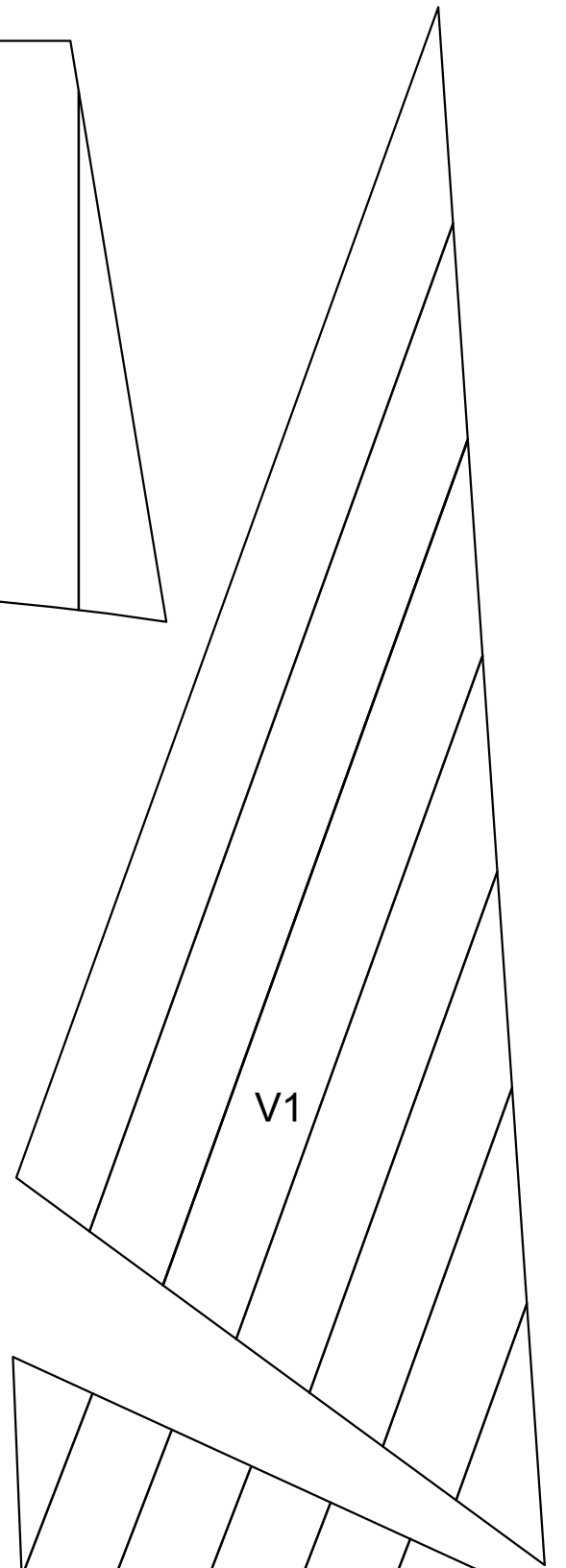
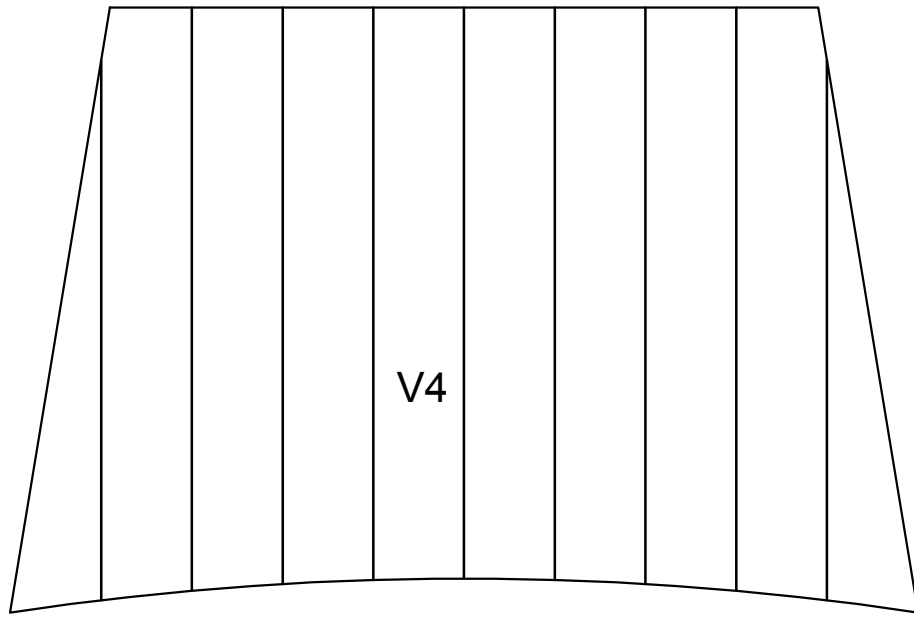
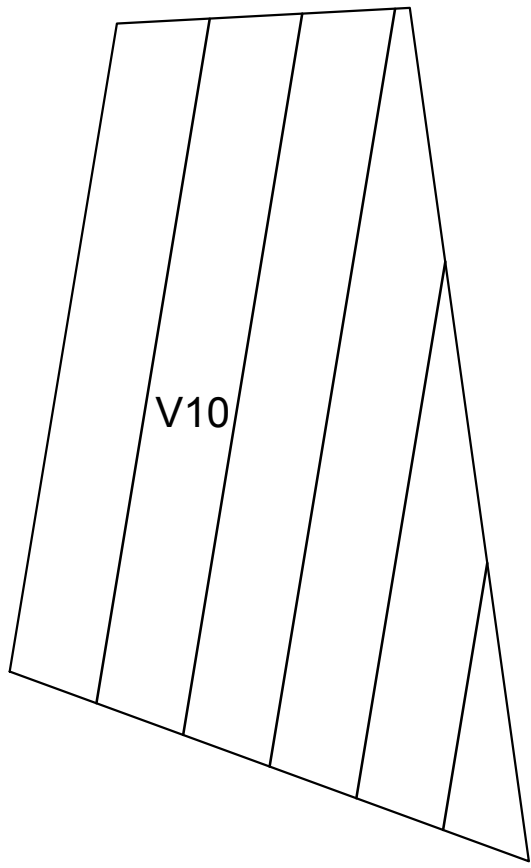

Terror

