

BLADE

120 S2



**Instruction Manual
Bedienungsanleitung
Manuel d'utilisation
Manuale di Istruzioni**

SAFE

BNF
BASIC

RTF
READY-TO-FLY

HORIZON
H O B B Y

NOTICE

All instructions, warranties and other collateral documents are subject to change at the sole discretion of Horizon Hobby, LLC. For up-to-date product literature, visit horizonhobby.com or towerhobbies.com and click on the support or resources tab for this product.

Meaning of Special Language

The following terms are used throughout the product literature to indicate various levels of potential harm when operating this product:

WARNING: Procedures, which if not properly followed, create the probability of property damage, collateral damage, and serious injury OR create a high probability of superficial injury.

CAUTION: Procedures, which if not properly followed, create the probability of physical property damage AND a possibility of serious injury.

NOTICE: Procedures, which if not properly followed, create a possibility of physical property damage AND a little or no possibility of injury.



WARNING: Read the ENTIRE instruction manual to become familiar with the features of the product before operating. Failure to operate the product correctly can result in damage to the product, personal property and cause serious injury.

This is a sophisticated hobby product. It must be operated with caution and common sense and requires some basic mechanical ability. Failure to operate this Product in a safe and responsible manner could result in injury or damage to the product or other property. This product is not intended for use by children without direct adult supervision. Do not use with incompatible components or alter this product in any way outside of the instructions provided by Horizon Hobby, LLC. This manual contains instructions for safety, operation and maintenance. It is essential to read and follow all the instructions and warnings in the manual, prior to assembly, setup or use, in order to operate correctly and avoid damage or serious injury.

Age Recommendation: Not for children under 14 years. This is not a toy.

Safety Precautions and Warnings

- Always keep a safe distance in all directions around your model to avoid collisions or injury. This model is controlled by a radio signal subject to interference from many sources outside your control. Interference can cause momentary loss of control.
- Always operate your model in open spaces away from full-size vehicles, traffic and people.
- Always carefully follow the directions and warnings for this and any optional support equipment (chargers, rechargeable battery packs, etc.).
- Always keep all chemicals, small parts and anything electrical out of the reach of children.
- Always avoid water exposure to all equipment not specifically designed and protected for this purpose. Moisture causes damage to electronics.
- Never place any portion of the model in your mouth as it could cause serious injury or even death.
- Never operate your model with low transmitter batteries.
- Always keep aircraft in sight and under control.
- Always move the throttle fully down at rotor strike.
- Always use fully charged batteries.
- Always keep transmitter powered on while aircraft is powered.
- Always remove batteries before disassembly.
- Always keep moving parts clean.
- Always keep parts dry.
- Always let parts cool after use before touching.
- Always remove batteries after use.
- Never operate aircraft with damaged wiring.
- Never touch moving parts.

Table of Contents

Box Contents	3	Flying the 120 S2	11
First Flight Preparation	4	Drift Calibration	12
Flying Checklist	4	Post-Flight Inspection and Maintenance Checklist	12
Charging Warnings	4	Troubleshooting Guide	12
Battery Charging	4	Exploded View	14
Installing the Transmitter Batteries (RTF)	5	Parts List	14
Transmitter Setup (BNF)	5	Limited Warranty	15
Installing the Flight Battery	8	Warranty and Service Contact Information	16
Transmitter and Receiver Binding	8	FCC Information	16
RTF Transmitter Controls	9	IC Information	16
Control Tests	10	Compliance Information for the European Union	17
Understanding the Primary Flight Controls	10		

Specifications

Length	12.6 in (320mm)	Tail Rotor Diameter	2.75 in (70mm)
Height	4.25 in (108mm)	Flying Weight	3.74 oz (106 g)
Main Rotor Diameter	13 in (330mm)		

Box Contents

- Blade 120 S2
- 500mAh 1S 3.7V 25C Li-Po Battery
- 1S Li-Po USB Charger
- MLP6DSM SAFE 6 Channel Transmitter (RTF Only)
- 4 AA Batteries (RTF Only)

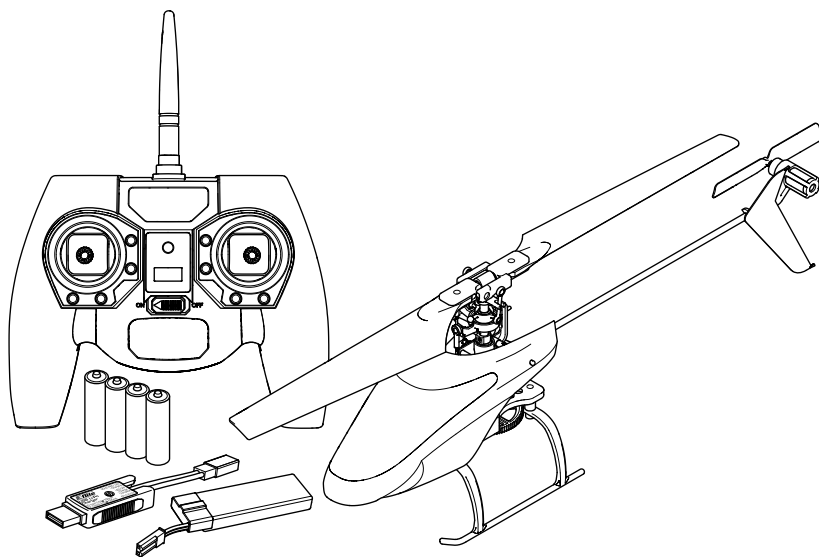

First Flight Preparation

- Remove and inspect contents
- Begin charging the flight battery
- Install the batteries in the transmitter (RTF only)
- Program your computer transmitter (BNF only)
- Install the flight battery in the helicopter (once it has been fully charged)
- Bind your transmitter (BNF only)
- Familiarize yourself with the controls
- Find a suitable area for flying

Flying Checklist

- Always turn the transmitter on first**
- Plug the flight battery into the lead from the ESC
- Allow the receiver and ESC to initialize and arm properly
- Fly the model
- Land the model
- Unplug the flight battery from the ESC
- Always turn the transmitter off last**

Charging Warnings



CAUTION: All instructions and warnings must be followed exactly. Mishandling of Li-Po batteries can result in a fire, personal injury and/or property damage.

- **NEVER LEAVE CHARGING BATTERIES UNATTENDED.**
- **NEVER CHARGE BATTERIES OVERNIGHT.**
- By handling, charging or using the included Li-Po battery, you assume all risks associated with lithium batteries.
- If at any time the battery begins to balloon or swell, discontinue use immediately. If charging or discharging, discontinue and disconnect. Continuing to use, charge or discharge a battery that is ballooning or swelling can result in fire.
- Always store the battery at room temperature in a dry area for best results.
- Always transport or temporarily store the battery in a temperature range of 40–120° F (5–49° C).
- Do not store battery or model in a car or direct sunlight. If stored in a hot car, the battery can be damaged or even catch fire.
- Always charge batteries away from flammable

materials.

- Always inspect the battery before charging
- Always disconnect the battery after charging, and let the charger cool between charges.
- Always constantly monitor the temperature of the battery pack while charging.
- **ONLY USE A CHARGER SPECIFICALLY DESIGNED TO CHARGE LI-PO BATTERIES.** Failure to charge the battery with a compatible charger may cause a fire resulting in personal injury and/or property damage.
- Never discharge Li-Po cells to below 3V under load.
- Never cover warning labels with hook and loop strips.
- Never charge batteries outside recommended levels.
- Never charge damaged batteries.
- Never attempt to dismantle or alter the charger.
- Never allow minors to charge battery packs.
- Never charge batteries in extremely hot or cold places (recommended between 40–120° F or (5–49° C) or place in direct sunlight.

Battery Charging

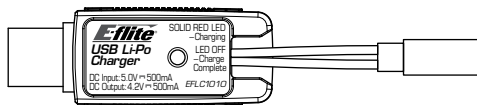

NOTICE: Charge only batteries that are cool to the touch and are not damaged. Look at the battery to make sure it is not damaged e.g., swollen, bent, broken or punctured.

1. Insert the charger into a USB port.
2. Properly connect the battery to the charger lead.
3. Always disconnect the flight battery from the charger immediately upon completion of charging.



CAUTION: Only use chargers specifically designed to charge the included Li-Po battery. Failure to do so could result in fire, causing injury or property damage.



CAUTION: Never exceed the recommended charge rate.

LED Indications

When you make the connection successfully, the LED on the charger turns solid red, indicating charging has begun. Charging a fully discharged (not over-discharged) 500mAh battery takes approximately 60 minutes. The light goes off when the charge is complete.

CHARGING (Solid Red)

MAX CHARGE (OFF)



CAUTION: Once charging is complete, immediately remove the battery. Never leave a battery connected to the charger.

Installing the Transmitter Batteries (RTF)

Replace the transmitter batteries when the transmitter beeps.

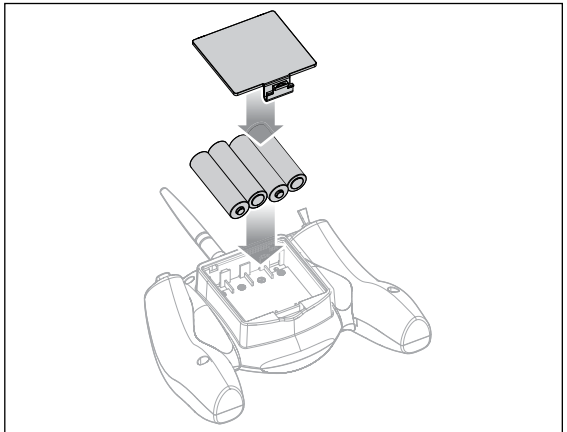

Transmitter Setup (BNF)

Program your transmitter before attempting to bind or fly the helicopter. Transmitter programming values are shown below for the Spektrum DX6i, DX7s, DX6, DX7, DX8, DX9 and DX18.

The files for models using Spektrum™ transmitters with Spektrum AirWare™ software are also available for download online at www.spektrumrc.com. Your helicopter is also compatible with Spektrum DXe radios with software version 1.3 or higher. Use the directions below to reverse channel 6, or use the appropriate programming cable and the PC or mobile app to program the DXe. We recommend downloading the Blade 120 S2 DXe model setup available at www.spektrumrc.com.

If you are programming your DXe using the PC or mobile app, make sure the "Transmitter Channels" value is set to the default of 7. If for any reason this value is changed to 9, the 120 S2 will bind to the DXe, but will not respond to control inputs.

If your DXe was included in another Blade® Ready To Fly (RTF) helicopter, the transmitter software will have to be updated using the appropriate programming cable and either the PC or mobile app available at www.spektrumrc.com. Please note, the switch configuration used for DXe transmitters included with the Blade 230 S RTF and Micro AH-64 Apache™ RTF varies from the standard DXe layout.

DXe

To use the DXe transmitter with the Blade 120 S2, channel 6 must be reversed.

To reverse channel 6:

1. While powering on the DXe, hold the left and right sticks in the top-inside corners as shown.
2. Re-center the sticks after the transmitter beeps. The LED will flash slowly.
3. To select a channel to reverse, move the right stick to the left or right and allow it to re-center. Move the stick to the right to select the next channel. Move the stick to the left to select the previous channel. The LED will flash rapidly corresponding to the channel selected, as shown in the table. Select channel 6.
4. To reverse the selected channel, move the right stick up or down. The LED will change color to indicate the new channel direction.
5. The LED will flash **Orange** to indicate the channel is **normal**. The LED will flash **Red** to indicate the channel is **reversed**.
6. To store the changes, power off the DXe.



CAUTION: During the subsequent power up, always verify the throttle direction is correct and keep clear of the motor and rotor blades. Failure to do so may result in injury or damage to the product.

After reversing channel 6, bind the transmitter and helicopter normally.

Flight modes are controlled by the Flight Mode switch.

Panic Mode is controlled by the Bind/Panic/Trainer button.

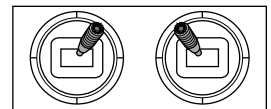

LED Flashes	Channel
1	1-Throttle
2	2-Aileron
3	3-Elevator
4	4-Rudder
5	5-Flight Mode
6	6-Panic
7	7-Flaps
8	8-Aux Channel

Once bound, the LED in the helicopter should glow green blue or red, depending on the flight mode selected.

If the LED glows green in FM-0 mode or blue in FM-1/FM-2 modes, channel 6 has not been reversed correctly. Use the directions above to reverse channel 6. If the LED flashes red, replace the flight battery with a fully charged battery.

DX6i

SETUP LIST	
Model Type	Acro
REVERSE	
Channel	Direction
THRO	N
AILE	N
ELEV	N
RUDD	N
GEAR	R
FLAP	N
Modulation Type	
AUTO DSMX-ENABLE	
D/R COMBI	
D/R SW	AILE
Timer	
Down Timer	5:00
Switch	THR CUT

ADJUST LIST			
TRAVEL ADJ		D/R & Expo	
Channel	Travel	Chan	Sw Pos
THRO	100/100	AILE	0
AILE	100/100		1
ELEV	100/100	ELEV	0
RUDD	100/100		1
GEAR	100/100	RUDD	0
PITC	100/100		1
FLAPS			Mixing
	FLAP	ELEV	MIX 1
NORM	↑100	0	GEAR > GEAR
LAND	↓100	0	RATE
			SW
			MIX 2
			GEAR > GEAR
			RATE
			SW

Panic Mode Operation

Gyro Switch: Pos 0 = Panic Mode Off
Pos 1 = Panic Mode On

Flight Mode Operation

Gear Sw: Pos 0, *Elev D/R Sw:* 0 or 1 = Stability, Low-Angle Mode
Gear Sw: Pos 1, *Elev D/R Sw:* 0 = Stability, High-Angle Mode
Gear Sw: Pos 1, *Elev D/R Sw:* 1 = Agility Mode

DX7s

SYSTEM SETUP	
Model Type	ACRO
SW Select	
Trainer	Aux 1
Flap	Gear
All Others	INH

FUNCTION LIST					
Servo Setup					
Chan	Travel	Reverse	Chan	Travel	Reverse
THR	100/100	Normal	GER	100/100	Normal
AIL	100/100	Normal	AX1	100/100	Reverse
ELE	100/100	Normal	AX2	100/100	Normal
RUD	100/100	Normal			
D/R & Expo			D/R & Expo		
Chan	Switch Pos (FLAP)	D/R	Expo*	Chan	Switch Pos (FLAP)
AILE	0	100/100	0	RUDD	0
	1	100/100	0		1
	2	75/75	0		2
ELEV	0	100/100	0		
	1	100/100	0		
	2	75/75	0		
Throttle Cut			Timer		
Switch		Mix 1	Mode	Count Down	
			Time	5:00 Tone	
			Start	Throttle Out	
			Pos	25%	

Panic Mode Operation

Trainer/Bind Button
Pressed = Panic Mode On
Released = Panic Mode Off

Flight Mode Operation

FLAP Sw: Pos 0 = Stability, Low-Angle Mode
Pos 1 = Stability, High-Angle Mode
Pos 2 = Agility Mode

* Use of "Expo" is not necessary for successful flight of the 120 S2. The pilot may adjust this setting to tailor the sensitivity of the helicopter around neutral if desired.

DX8

SYSTEM SETUP	
Model Type	ACRO
SW Select	
Trainer	Aux 1
F Mode	Gear
All Others	INH

FUNCTION LIST							
Servo Setup							
Chan	Travel	Reverse	Chan	Travel	Reverse		
THR	100/100	Normal	GER	100/100	Normal		
AIL	100/100	Normal	AX1	100/100	Reverse		
ELE	100/100	Normal	AX2	100/100	Normal		
RUD	100/100	Normal					
D/R & Expo				D/R & Expo			
Chan	Switch Pos (AIL D/R)	D/R	Expo*	Chan	Switch Pos (AIL D/R)	D/R	Expo*
AILE	0	100/100	0	RUDD	0	100/100	0
	1	100/100	0		1	100/100	0
	2	75/75	0		2	75/75	0
ELEV	0	100/100	0				
	1	100/100	0				
	2	75/75	0				
Throttle Cut				Timer			
Switch		Mix 1		Mode	Count Down		
				Time	5:00 Tone		
				Start	Throttle Out		
				Pos	25%		

Panic Mode Operation

Trainer/Bind Button

Pressed = Panic Mode On

Released = Panic Mode Off

Flight Mode Operation

F MODE Sw: Pos 0 = Stability, Low-Angle Mode

Pos 1 = Stability, High-Angle Mode

Pos 2 = Agility Mode

DX6, DX6e, DX7 (Gen 2), 8e, DX9, DX18, iX12, iX20

SYSTEM SETUP	
Model Type	Airplane
F-Mode Setup	
Switch 1	Switch B
Switch 2	Inhibit
Channel Assign	
Channel Input	
1 Throttle	N/A
2 Aileron	N/A
3 Elevator	N/A
4 Rudder	N/A
5 Gear	B
6 AUX 1	I

FUNCTION LIST						
Servo Setup						
Chan	Travel	Reverse	Chan	Travel	Reverse	
THR	100/100	Normal	AX1	100/100	Reverse	
AIL	100/100	Normal	AX2	100/100	Normal	
ELE	100/100	Normal	AX3	100/100	Normal	
RUD	100/100	Normal	AX4	100/100	Normal	
GER	100/100	Normal				
D/R & Expo				Throttle Cut		
Chan	Switch (F) Pos		D/R	Expo*	Position	-130
	DX6	DX7, 9, 18			Switch	Switch H
AILE	0	0	100/100	0		
	1	1	100/100	0		
ELEV	1	2	75/75	0		
	0	0	100/100	0		
RUDD	0	1	100/100	0		
	1	2	75/75	0		
	0	0	100/100	0		
	1	1	100/100	0		
	1	2	75/75	0		
				Timer		
				Mode	Count Down	
				Time	5:00	
				Start	Throttle Out	
				Over	25%	
				One Time	Inhibit	

Panic Mode Operation

Bind / I Button

Pressed = Panic Mode On

Released = Panic Mode Off

Flight Mode Operation

Sw B: Pos 0 = Stability, Low-Angle Mode

Pos 1 = Stability, High-Angle Mode

Pos 2 = Agility Mode

* Use of "Expo" is not necessary for successful flight of the 120 S2. The pilot may adjust this setting to tailor the sensitivity of the helicopter around neutral if desired.

Installing the Flight Battery

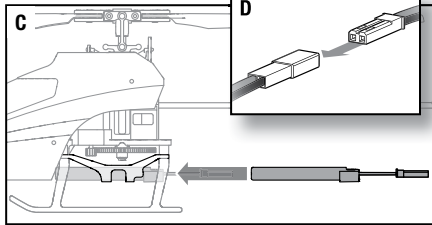
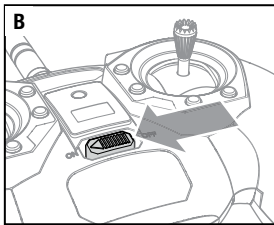
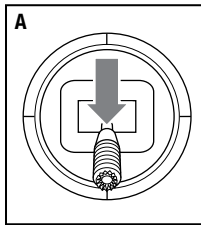

1. Lower the throttle stick to the lowest position **(A)** and center all trims.
2. Set the flight mode switch to Stability, Low Bank Angle Mode (FM-0)
3. Power ON the transmitter **(B)**.
4. Slide the flight battery fully into the mount of the helicopter frame **(C)**.
5. Connect the power lead to the battery **(D)**, noting the correct polarity.

CAUTION: Connecting the battery to the control board with reversed polarity will cause damage to the control board, the battery or both. Damage caused by incorrectly connecting the battery is not covered under warranty.

6. Keep the aircraft from moving. The LED quickly flashes red followed by a quick green flash and then cycles red, green, blue and red, indicating initialization is complete.

After initialization is complete:

- If the aircraft is bound correctly to the transmitter, the LED will change to show the currently selected flight mode.
- If the LED on the control board flashes blue rapidly, indicating the aircraft is in bind mode, proceed to the Transmitter and Receiver Binding section to bind the aircraft and transmitter.
- If the LED flashes blue slowly, the flight controller lost communication with the transmitter.
- If the LED flashes red, the flight controller has hit the low voltage cutoff (LVC). Replace the flight battery with a fully charged battery.

CAUTION: Always disconnect the Li-Po battery from the aircraft when not flying to avoid over-discharging the battery. Batteries discharged to a voltage lower than the lowest approved voltage may become damaged, resulting in loss of performance and potential fire when batteries are charged.

Transmitter and Receiver Binding

Your RTF transmitter comes prebound to the model. If you need to re-bind, follow the directions below.

MLP6DSM Binding Procedure (RTF)

1. Disconnect the flight battery from the helicopter.
2. Center all trims on your transmitter.
3. Power off the transmitter and move the throttle stick to the down/off position.
4. Connect the flight battery in the helicopter, and keep the helicopter from moving. The LED on the control board continually flashes blue after the aircraft initializes, indicating the control board is in bind mode.
5. Push in and hold down the left stick* while powering on the transmitter (you will hear a 'click').
6. Release the left stick. The transmitter will beep and the power LED will blink.
7. The helicopter is bound when the LED on the control board is solid (not blinking).
8. Disconnect the flight battery and power the transmitter off.

* The trigger switch may also be used for the binding procedure.

If you encounter problems, obey binding instructions and refer to the troubleshooting guide for other instructions. If needed, contact the appropriate Horizon Product Support office.

To bind or re-bind your helicopter to your chosen transmitter, follow the directions below.

General Binding Procedure (BNF)

1. Disconnect the flight battery from the helicopter.
2. Refer the Transmitter Setup Table to correctly setup your transmitter.
3. Lower the throttle stick to the lowest position and center all trims on your transmitter.
4. Power off the transmitter and move all switches to the 0 position. Move the throttle to the low/off position.
5. Connect the flight battery to the control board. The control board LED rapidly flashes blue, indicating it is in bind mode.
6. Put the transmitter into bind mode while powering on the transmitter.
7. Release the bind button/switch after 2–3 seconds. The helicopter is bound when the LED on the receiver turns solid.
8. Disconnect the flight battery and power the transmitter off.



CAUTION: When using a Futaba® transmitter with a Spektrum™ DSM2® module, you must reverse the throttle channel and re-bind. Refer to your Spektrum module manual for binding and failsafe instructions. Refer to your Futaba transmitter manual for instructions on reversing the throttle channel.

RTF Transmitter Controls

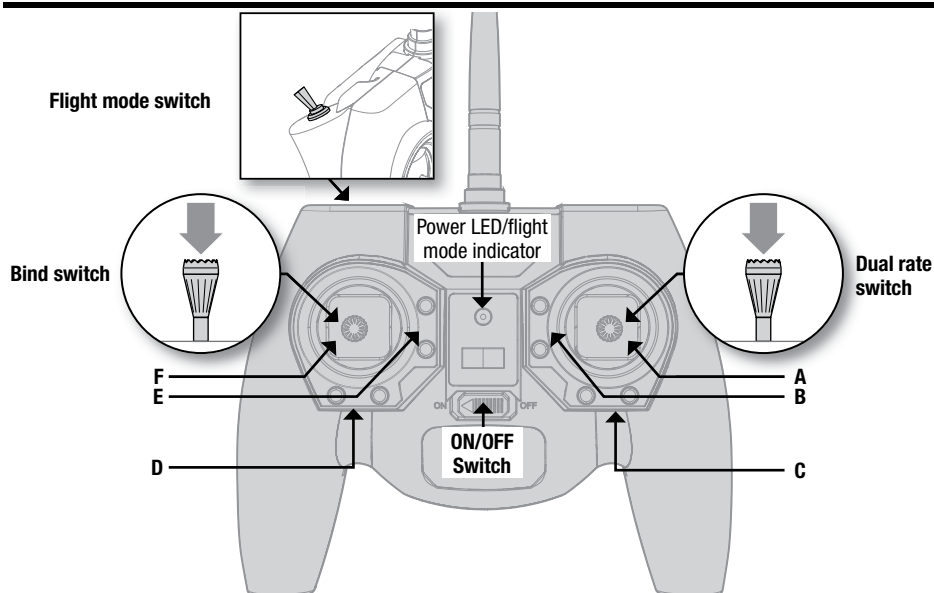

When pressed down, trim buttons make a sound that increases or decreases in pitch at each pressing. The middle or neutral trim position is heard as a middle tone in the pitch range of the sounds. The end of the control range is sounded by a series of beeps.

Dual Rate Selection

The control sensitivity can be changed by pressing and releasing the right control stick. The LED on the transmitter will show solid for high sensitivity (default) and flashing for low sensitivity.

	A	B	C	D	E	F
Mode 2	Aileron (Left/Right) Elevator (Up/Down)	Elevator Trim	Aileron Trim	Rudder Trim	Throttle Trim	Rudder (Left/Right) Throttle (Up/Down)

Control Tests

Test the controls prior to the first flight to ensure the servos, linkages and parts operate correctly. Ensure the throttle is in the low position when doing the control tests.

Elevator

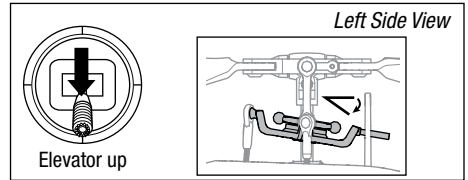
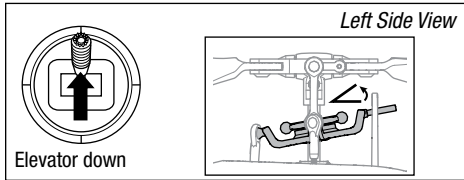

Aileron

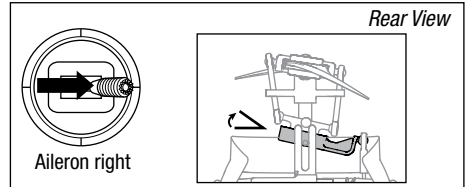
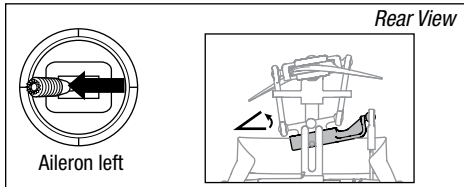

Understanding the Primary Flight Controls

If you are not familiar with the controls of your 120 S2, take a few minutes to familiarize yourself with them before attempting your first flight.

Throttle

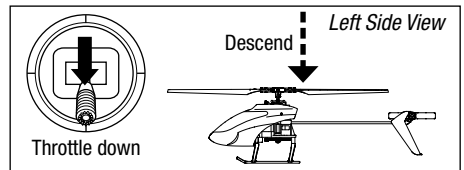
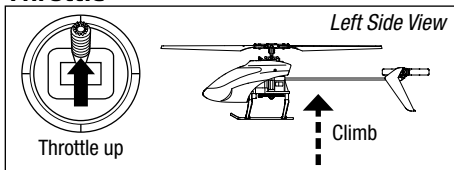

Rudder

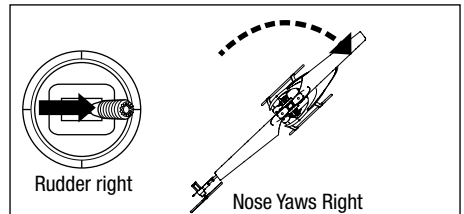
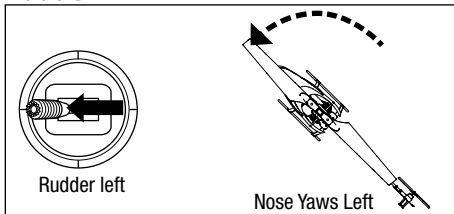

Elevator

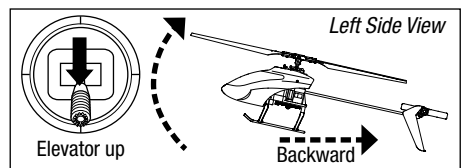
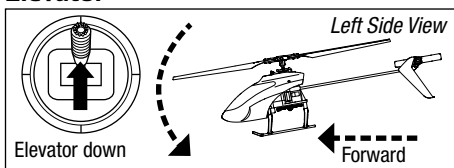

Aileron

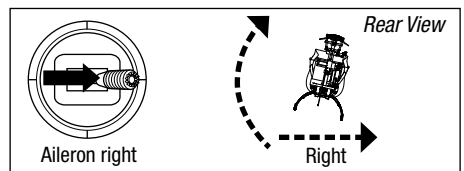
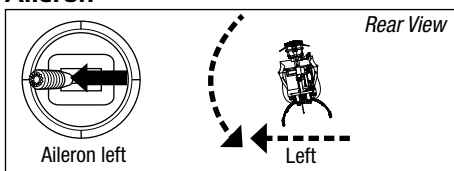

Flying the 120 S2

Consult your local laws and ordinances before choosing a location to fly your aircraft.

We recommend flying your aircraft outside in calm winds (3 MPH or less) or inside a large gymnasium. Always avoid flying near houses, trees, wires and buildings. You should also be careful to avoid flying in areas where there are many people, such as busy parks, schoolyards or soccer fields.

It is best to fly from a smooth flat surface as this will allow the model to slide without tipping over. Keep the helicopter approximately 2 ft (600mm) above the ground. Keep the tail pointed toward you during initial flights to keep the control orientation consistent. Releasing the stick while in Stability, low bank angle mode or Stability, high bank angle mode will allow the helicopter to level itself and activating the Panic Switch will level the helicopter quickly. If you become disoriented, slowly lower the throttle stick to land softly. During initial flights, only attempt hovering the model in one spot and takeoff and landing.

Takeoff

Place the model onto a flat, level surface free of obstacles and walk back 30 feet (10 meters). Slowly increase the throttle until the model is approximately 2 ft. (600mm) off the ground and check the trim so the model flies as desired. Once the trim is adjusted, begin flying the model. Typical flight time for the included battery is approximately 6 minutes.

Hovering

Making small corrections on the transmitter, try to hold the helicopter in one spot. If flying in calm winds, the model should require almost no corrective inputs. After moving the cyclic stick and returning it to center the model should level itself. The model may continue to move due to inertia. Move the cyclic stick in the opposite direction to stop the movement.

Do not use the trims on the transmitter to eliminate drift. If the helicopter does not hold a reasonable hover in calm conditions, perform the *Drift Calibration*.

After you become comfortable hovering, you can progress into flying the model to different locations, keeping the tail pointed towards you at all times. You can also ascend and descend using the throttle stick. Once you're comfortable with these maneuvers, you can attempt flying with the tail in different orientations. It is important to keep in mind that the flight control inputs will rotate with the helicopter, so always try to picture the control inputs relative to the nose of the helicopter. For example, forward will always drop the nose of the helicopter.

Low Voltage Cutoff (LVC)

LVC decreases the power to the motors when the battery voltage gets low. When the motor power decreases and the red LED on the ESC flashes, land the aircraft immediately and recharge the flight battery.

LVC does not prevent the battery from over-discharge during storage.

NOTICE: Repeated flying to LVC will damage the battery.

Landing

To land, slowly decrease the throttle while in a low-level hover. After landing, disconnect and remove the battery from the aircraft after use to prevent trickle discharge. Fully charge your battery before storing it. During storage, make sure the battery charge does not fall below 3V per cell.

Flight Modes

Stability, Low Bank Angle Mode (FM-0): The receiver LED shows solid green. This flight mode allows a low bank angle and slower flight speed. When the cyclic stick is released the model will self-level.

Stability, High Bank Angle Mode (FM-1): The receiver LED shows solid blue. This flight mode allows a high bank angle and faster flight speed. When the cyclic stick is released the model will self-level.

Agility Mode (FM-2): The receiver LED shows solid red. The bank angle is not limited. When the cyclic stick is released the model will **not** self-level.

Drift Calibration

The helicopter has been calibrated in the factory before shipment, but it is possible that a crash will cause mechanical distortion of the frame, resulting in a slight drift in Stability mode. In this situation, please follow the calibration procedure.

Before beginning the calibration procedure, fully charge the flight battery and ensure the helicopter and transmitter are bound properly, per the binding instructions.

To Calibrate the Blade 120 S2:

1. After initialization, move the transmitter sticks to the bottom, outside corners, as shown in the illustration.

When the red and blue LEDs on the main flight control board glow solid, calibration mode is active.

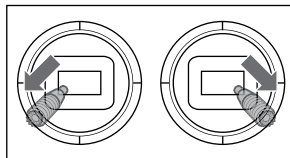

2. Release the sticks.
3. Slowly advance the throttle to bring the helicopter into a low hover. The red and blue LEDs flash continuously to indicate the calibration process has begun. Hold the hover for approximately 15 seconds, using as little control input as possible to keep the helicopter steady.
4. Land the helicopter by slowly lowering the throttle.
5. After landing, press the bind/panic button to complete the calibration process. The LED will show solid blue.

Post-Flight Inspection and Maintenance Checklist

Ball Links	Make sure the plastic ball link holds the control ball, but is not tight (binding) on the ball. When a link is too loose on the ball, it can separate from the ball during flight and cause a crash. Replace worn ball links before they fail.
Cleaning	Make sure the battery is not connected before cleaning. Remove dust and debris with a soft brush or a dry, lint-free cloth.
Bearings	Replace bearings when they become notchy (sticky in places when turning) or draggy.
Wiring	Make sure the wiring does not contact moving parts. Replace damaged wiring and loose connectors.
Fasteners	Make sure there are no loose screws, other fasteners or connectors. Do not over-tighten metal screws in plastic parts. Tighten screws so the parts are mated together, then turn the screw only 1/8th of a turn more.
Rotors	Make sure there is no damage to rotor blades and other parts which move at high speed. Damage to these parts includes cracks, burrs, chips or scratches. Replace damaged parts before flying. Verify both main rotor blades have the correct and equal tension in the blade grips. When the helicopter is held up sideways, the main blades should support their own weight. When the helicopter is shaken lightly, the blades should fall.
Tail	Inspect the tail rotor for damage and replace if necessary. Inspect the tail boom for any damage and replace if necessary.
Mechanics	Inspect the main frame and landing gear for damage and replace if necessary. Check the mainshaft for vertical play and adjust the locking collar if necessary. Verify that the main gear mesh is correct and that no tight spots exist in the 360 degree rotation. Inspect all wires for damage and replace as necessary.

Troubleshooting Guide

Problem	Possible Cause	Solution
Helicopter is bound to a Spektrum DXe but will not respond to control input	The transmitter is in 9-channel mode	Using the appropriate DXe programming cable and PC or mobile app, either change the transmitter to 7-channel mode or download the Blade 120 S2 model setup file to your transmitter from www.spektrumrc.com
Helicopter will not respond to throttle	Throttle too high and/or throttle trim is too high	Disconnect the flight battery, place the throttle stick in the lowest position and lower the throttle trim a few clicks. Connect the flight battery and allow the model to initialize
	Helicopter moved during initialization	Disconnect the flight battery and re-initialize the helicopter while keeping the helicopter from moving

Problem	Possible Cause	Solution
Helicopter has reduced flight time or is underpowered	Flight battery charge is low	Completely recharge the flight battery
	Flight battery is damaged	Replace the flight battery and follow the flight battery instructions
	Flight conditions might be too cold	Make sure the battery is warm (room temperature) before use
LED on receiver flashes rapidly and aircraft will not respond to transmitter (during binding)	Transmitter too near aircraft during binding process	Power off the transmitter. Move the transmitter a larger distance from the aircraft. Disconnect and reconnect the flight battery to the aircraft. Follow the binding instructions
	Bind switch or button was not held while transmitter was powered on	Power off transmitter and repeat bind process
	Aircraft or transmitter is too close to large metal object, wireless source or another transmitter	Move aircraft and transmitter to another location and attempt binding again
LED on the receiver flashes rapidly and the helicopter will not respond to the transmitter (after binding)	Less than a 5-second wait between first powering on the transmitter and connecting the flight battery to the helicopter	Leave the transmitter powered on. Disconnect and reconnect the flight battery to the helicopter
	The helicopter is bound to a different model memory (ModelMatch™ transmitters only)	Select the correct model memory on the transmitter. Disconnect and reconnect the flight battery to the helicopter
	Flight battery or transmitter battery charge is too low	Replace or recharge batteries
	Aircraft or transmitter is too close to large metal object, wireless source or another transmitter	Move aircraft and transmitter to another location and attempt connecting again
Helicopter vibrates or shakes in flight	Damaged rotor blades, spindle, blade grips, main gear teeth or cracked main shaft.	Check main rotor blades, blade grips, main gear and main shaft for cracks, chips or missing teeth. Replace damaged parts. Replace bent spindle
	Rotor head linkages not connected correctly	Connect the rotor head linkages to the short ball links on the swashplate
Model does not hold level/ Panic recovery does not level. Random movements in flight	Vibration	Verify the receiver is properly attached to the helicopter. Verify that no wires are contacting the receiver. Inspect and balance all rotating components. Verify the main shaft and tail rotor adapter are not damaged or bent. Inspect mechanics for broken or damaged parts and replace as necessary
Tail oscillation/wag or poor performance	Loose tail boom, damaged tail rotor, loose bolts, vibration	Verify that the boom is tight and completely inserted into the frame. Inspect the tail rotor for damage. Verify the tail motor mount is tight. Replace any damaged or worn components
Drift in calm winds	Vibration, damaged linkage, damaged servo	Under normal operation the transmitter trims should not require adjustment and the center positions are memorized during initialization. If you find that trim adjustments are necessary after take off, verify the balance of all rotating components, ensure the linkages are not damaged and make sure the servos are in proper working condition. Perform the <i>Drift Calibration</i> procedure
Drift in wind	Normal	The model will drift with the wind but should remain level in flight. Simply hold the cyclic stick in the necessary position to keep the model stationary. The model must lean into the wind to remain stationary, if the model remains level then it will drift with the wind
Severe vibration	Rotating component out of balance	Check the main shaft, tail rotor, main rotor blades, main frame and adapter for damage, replace as necessary. Vibration must be minimized for Panic Recovery and Return to Level functions to work properly

Exploded View

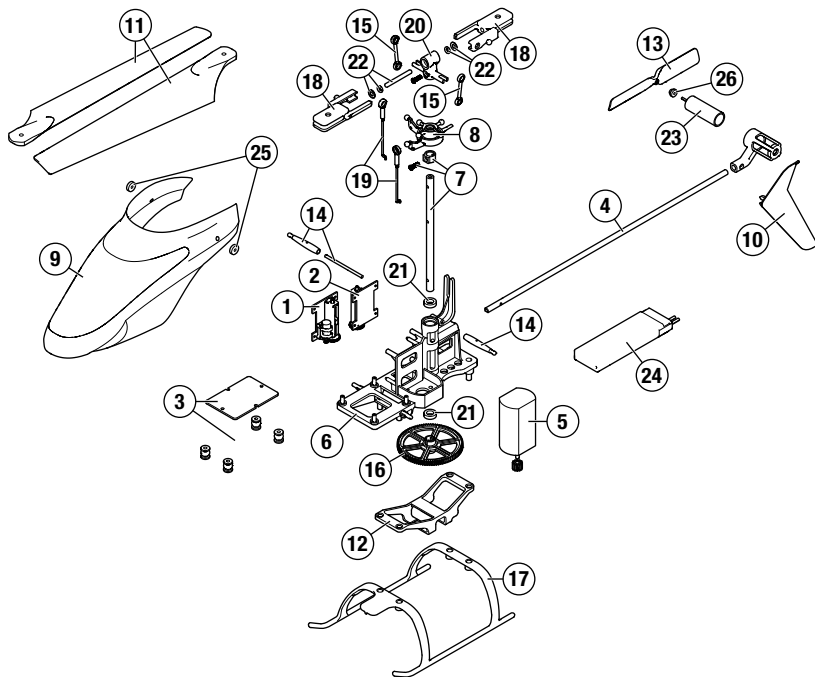

Parts List

Part #	Description	Part #	Description		
	BLH1100	120 S2 RTF	15	BLH3115	Rotor Head Linkage
	BLH1180	120 S2 BNF	16	BLH3106	Main gear
1	SPMSH2029L	Linear Long, 35mm lead	17	BLH3709	Landing gear Set
2	SPMSH2030L	Linear Long, 60mm lead	18	BLH3114	Main Blade grips with Hardware and screws
3	BLH1101	Main Control Board	19	BLH3108	Servo Pushrod Set with Ball link (2)
4	BLH4102	Tail Boom Set	20	BLH3112	Main Rotor Hub with Hardware
5	BLH4103	Main Motor	21	BLH3128	Main Shaft Bearing 4 x 7 x 2
6	BLH4104	Main Frame	22	BLH3113	Feathering Spindle w/O-rings and bushings
7	BLH4105	Main Shaft w/hardware	23	BLH4113	Tail Motor
8	BLH4106	Swashplate	24	EFLB5001S25	1S, 500 mAh, 25C LiPo Battery, JST
9	BLH1102	Canopy	25	BLH3121	Canopy Mounting Grommets (8)
10	BLH1103	Tail Fin	26	BLH3125	Tail Motor Protective Sleeve
11	BLH4111	Main Blades w/screws		BLH4109	Screw set: 120 S
12	BLH4112	Battery Frame		SPMRMLP6	MLP6D5M SAFE 6ch Tx
13	BLH3117	Tail Rotor		EFLC1010	1S USB LiPo Charger, 500mA
14	BLH3705	Canopy Mounts			

Limited Warranty

What this Warranty Covers

Horizon Hobby, LLC, (Horizon) warrants to the original purchaser that the product purchased (the "Product") will be free from defects in materials and workmanship at the date of purchase.

What is Not Covered

This warranty is not transferable and does not cover (i) cosmetic damage, (ii) damage due to acts of God, accident, misuse, abuse, negligence, commercial use, or due to improper use, installation, operation or maintenance, (iii) modification of or to any part of the Product, (iv) attempted service by anyone other than a Horizon Hobby authorized service center, (v) Product not purchased from an authorized Horizon dealer, (vi) Product not compliant with applicable technical regulations, or (vii) use that violates any applicable laws, rules, or regulations.

OTHER THAN THE EXPRESS WARRANTY ABOVE, HORIZON MAKES NO OTHER WARRANTY OR REPRESENTATION, AND HEREBY DISCLAIMS ANY AND ALL IMPLIED WARRANTIES, INCLUDING, WITHOUT LIMITATION, THE IMPLIED WARRANTIES OF NON-INFRINGEMENT, MERCHANTABILITY AND FITNESS FOR A PARTICULAR PURPOSE. THE PURCHASER ACKNOWLEDGES THAT THEY ALONE HAVE DETERMINED THAT THE PRODUCT WILL SUITABLY MEET THE REQUIREMENTS OF THE PURCHASER'S INTENDED USE.

Purchaser's Remedy

Horizon's sole obligation and purchaser's sole and exclusive remedy shall be that Horizon will, at its option, either (i) service, or (ii) replace, any Product determined by Horizon to be defective. Horizon reserves the right to inspect any and all Product(s) involved in a warranty claim. Service or replacement decisions are at the sole discretion of Horizon. Proof of purchase is required for all warranty claims. SERVICE OR REPLACEMENT AS PROVIDED UNDER THIS WARRANTY IS THE PURCHASER'S SOLE AND EXCLUSIVE REMEDY.

Limitation of Liability

HORIZON SHALL NOT BE LIABLE FOR SPECIAL, INDIRECT, INCIDENTAL OR CONSEQUENTIAL DAMAGES, LOSS OF PROFITS OR PRODUCTION OR COMMERCIAL LOSS IN ANY WAY, REGARDLESS OF WHETHER SUCH CLAIM IS BASED IN CONTRACT, WARRANTY, TORT, NEGLIGENCE, STRICT LIABILITY OR ANY OTHER THEORY OF LIABILITY, EVEN IF HORIZON HAS BEEN ADVISED OF THE POSSIBILITY OF SUCH DAMAGES.

Further, in no event shall the liability of Horizon exceed the individual price of the Product on which liability is asserted. As Horizon has no control over use, setup, final assembly, modification or misuse, no liability shall be assumed nor accepted for any resulting damage or injury. By the act of use, setup or assembly, the user accepts all resulting liability. If you as the purchaser or user are not prepared to accept the liability associated with the use of the Product, purchaser is advised to return the Product immediately in new and unused condition to the place of purchase.

Law

These terms are governed by Illinois law (without regard to conflict of law principals). This warranty gives you specific legal rights, and you may also have other rights which vary from state to state. Horizon reserves the right to change or modify this warranty at any time without notice.

WARRANTY SERVICES

Questions, Assistance, and Services

Your local hobby store and/or place of purchase cannot provide warranty support or service. Once assembly, setup or use of the Product has been started, you must contact your local distributor or Horizon directly. This will enable Horizon to better answer your questions and service you in the event that

you may need any assistance. For questions or assistance, please visit our website at www.horizonhobby.com, submit a Product Support Inquiry, or call the toll free telephone number referenced in the Warranty and Service Contact Information section to speak with a Product Support representative.

Inspection or Services

If this Product needs to be inspected or serviced and is compliant in the country you live and use the Product in, please use the Horizon Online Service Request submission process found on our website or call Horizon to obtain a Return Merchandise Authorization (RMA) number. Pack the Product securely using a shipping carton. Please note that original boxes may be included, but are not designed to withstand the rigors of shipping without additional protection. Ship via a carrier that provides tracking and insurance for lost or damaged parcels, as Horizon is not responsible for merchandise until it arrives and is accepted at our facility. An Online Service Request is available at http://www.horizonhobby.com/content/service-center_render-service-center. If you do not have internet access, please contact Horizon Product Support to obtain a RMA number along with instructions for submitting your product for service. When calling Horizon, you will be asked to provide your complete name, street address, email address and phone number where you can be reached during business hours. When sending product into Horizon, please include your RMA number, a list of the included items, and a brief summary of the problem. A copy of your original sales receipt must be included for warranty consideration. Be sure your name, address, and RMA number are clearly written on the outside of the shipping carton.

NOTICE: Do not ship Li-Po batteries to Horizon. If you have any issue with a Li-Po battery, please contact the appropriate Horizon Product Support office.

Warranty Requirements

For Warranty consideration, you must include your original sales receipt verifying the proof-of-purchase date. Provided warranty conditions have been met, your Product will be serviced or replaced free of charge. Service or replacement decisions are at the sole discretion of Horizon.

Non-Warranty Service

Should your service not be covered by warranty, service will be completed and payment will be required without notification or estimate of the expense unless the expense exceeds 50% of the retail purchase cost. By submitting the item for service you are agreeing to payment of the service without notification. Service estimates are available upon request. You must include this request with your item submitted for service. Non-warranty service estimates will be billed a minimum of ½ hour of labor. In addition you will be billed for return freight. Horizon accepts money orders and cashier's checks, as well as Visa, MasterCard, American Express, and Discover cards. By submitting any item to Horizon for service, you are agreeing to Horizon's Terms and Conditions found on our website http://www.horizonhobby.com/content/service-center_render-service-center.

ATTENTION: Horizon service is limited to Product compliant in the country of use and ownership. If received, a non-compliant Product will not be serviced. Further, the sender will be responsible for arranging return shipment of the un-serviced Product, through a carrier of the sender's choice and at the sender's expense. Horizon will hold non-compliant Product for a period of 60 days from notification, after which it will be discarded.

10/15

Warranty and Service Contact Information

Country of Purchase	Horizon Hobby	Contact Information	Address
United States of America	Horizon Service Center (Repairs and Repair Requests)	servicecenter.horizonhobby.com/ RequestForm/	2904 Research Rd Champaign, Illinois, 61822 USA
	Horizon Product Support (Product Technical Assistance)	productsupport@horizonhobby.com 877-504-0233	
	Sales	websales@horizonhobby.com 800-338-4639	
European Union	Horizon Technischer Service	service@horizonhobby.eu	Hanskampring 9 D 22885 Barsbüttel, Germany
	Sales: Horizon Hobby GmbH	+49 (0) 4121 2655 100	

FCC Information

Contains FCC ID: BRWWAC01T

This device complies with part 15 of the FCC rules. Operation is subject to the following two conditions: (1) This device may not cause harmful interference, and (2) this device must accept any interference received, including interference that may cause undesired operation.



CAUTION: Changes or modifications not expressly approved by the party responsible for compliance could void the user's authority to operate the equipment.

This product contains a radio transmitter with wireless technology which has been tested and found to be compliant with the applicable regulations governing a radio transmitter in the 2.400GHz to 2.4835GHz frequency range.

Supplier's Declaration of Conformity

Blade 120 S2 RTF/BNF (BLH1100 / BLH1180)

FC This device complies with part 15 of the FCC Rules. Operation is subject to the following two conditions: (1) This device may not cause harmful interference, and (2) this device must accept any interference received, including interference that may cause undesired operation.



CAUTION: Changes or modifications not expressly approved by the party responsible for compliance could void the user's authority to operate the equipment.

NOTE: This equipment has been tested and found to comply with the limits for a Class B digital device, pursuant to part 15 of the FCC Rules. These limits are designed to provide reasonable protection against harmful interference in a residential installation. This equipment generates, uses and can radiate radio frequency energy and, if not installed and used in accordance with the instructions, may cause harmful interference to radio communications. However, there is no guarantee that interference will not occur in a particular installation. If this equipment does cause harmful interference to radio or television reception, which can be determined by turning the equipment off and on, the user is encouraged to try to correct the interference by one or more of the following measures:

- Reorient or relocate the receiving antenna.
- Increase the separation between the equipment and receiver.
- Connect the equipment into an outlet on a circuit different from that to which the receiver is connected.
- Consult the dealer or an experienced radio/TV technician for help.

Horizon Hobby, LLC
2904 Research Rd.
Champaign, IL 61822
Email: compliance@horizonhobby.com
Web: HorizonHobby.com

IC Information

Contains IC: 6157A-WAC01T

This device complies with Industry Canada license-exempt RSS standard(s). Operation is subject to the following two conditions:

(1) this device may not cause interference, and (2) this device must accept any interference, including interference that may cause undesired operation of the device.

Compliance Information for the European Union



EU Compliance Statement: Blade 120 S2 RTF (BLH1100)

Horizon Hobby, LLC hereby declares that this product is in compliance with the essential requirements and other relevant provisions of the RED, EMC, and LVD Directives.

A copy of the EU Declaration of Conformity is available online at:
<http://www.horizonhobby.com/content/support-render-compliance>.

Blade 120 S2 BNF (BLH1180)

Horizon Hobby, LLC hereby declares that this product is in compliance with the essential requirements and other relevant provisions of the RED and EMC Directives.

Instructions for disposal of WEEE by users in the European Union



This product must not be disposed of with other waste. Instead, it is the user's responsibility to dispose of their waste equipment by handing it over to a designated collections point for the recycling of waste electrical and electronic equipment. The separate collection

and recycling of your waste equipment at the time of disposal will help to conserve natural resources and make sure that it is recycled in a manner that protects human health and the environment. For more information about where you can drop off your waste equipment for recycling, please contact your local city office, your household waste disposal service or where you purchased the product.



E328



©2020 Horizon Hobby, LLC.

Blade, the Blade logo, E-Flite, BNF, the BNF logo, DSM, DSM2, DSMX, SAFE, the SAFE logo, Spektrum AirWare and ModelMatch are trademarks or registered trademarks of Horizon Hobby, LLC.

The Spektrum trademark is used with permission of Bachmann Industries, Inc.

All other trademarks, service marks and logos are property of their respective owners.

US 9,930,567. US 10,419,970. Other patents pending.

Created 3/20

61256

BLH1100, BLH1180